



Models

ALIEN654 ALIEN658 ALIEN666

ALIEN674(HDSDI) ALIEN678(HDSDI) ALIEN916(HDSDI)

Operations Manual

Alien Hero models

1080P recording at 25fps per channel on HD-SDI model –

4CIF recording at 25fps per channel on Std models -

Supports Universal Plug & Play for Port Forwarding –

2 x Hard Drive bays in 8 channel units –

8 x Hard Drive bays in 16 HD channel unit -

Uses up to 4Tb per Hard Drive -

HDMI, VGA & Composite on Alien916

Network access from iPhone, IPAD &

Android phones

Version 1.0

Regulatory Information

EU Conformity Statement



This product is marked "CE" and therefore complies with the European standards listed under the Low Voltage Directive 2006/95/EC and the EMC Directive 2004/108/EC.



This symbol on the products and/or accompanying documents means that used electronic equipment must not be mixed with general household waste. For treatment, recovery and recycling please return this unit to your trade supplier or local designated collection point as defined by your local council.

WEE/CG0783SS

Preventive and Cautionary Tips

Before connecting and operating your device, please be advised of the following tips:

- Ensure unit is installed in a well-ventilated, dust-free environment.
- Unit is installed for indoor use only.
- Keep all liquids away from the device.
- Ensure environmental conditions meet factory specifications.
- Ensure unit is properly secured to a rack or shelf. Major shocks or jolts may cause damage to the sensitive electronics within the unit.
- Use the device in conjunction with a UPS unit if possible.
- Power down the unit before connecting and disconnecting accessories and peripherals.
- Only use recommended HDDs in this device.
- Improper use or incorrect replacement of the Cadmium battery may damage the DVR. Only replace with the same or equivalent type only. Dispose of used batteries according to the instructions provided by the battery manufacturer.

Product Key Features

General

- PAL/NTSC adaptive video inputs.
- H.264 video compression with high reliability and superior definition.
- Encoding up to 4CIF resolution for ALIEN654, ALIEN658 and ALIEN666.
- Encoding up to 1080P resolution for ALIEN674, ALIEN678 and ALIEN916.
- HD models support HD-SDI
- Each channel supports dual-stream.
- Independent configuration for each channel, including resolution, frame rate, bit rate, image quality, etc.
- Input and output video quality is configurable.
- Normal and event recording parameters configurable per individual camera.
- Encoding for both audio/video composite stream and video stream; audio and video synchronisation during composite stream encoding.
- Watermark technology.

Local Monitoring

- Simultaneous HDMI/VGA and CVBS outputs on standard models and ALIEN916. HD models HDMI and VGA only on 4 & 8 channel units.
- HDMI/VGA output at up to 1920×1080 resolution.
- 1/4/6/8/9/16 displays (according to model) are supported.
- Display sequence of screens is adjustable.
- Live view screen can be switched in group, and manual switch and automatic cycle view is also provided, the interval of automatic cycle can be adjusted.
- Quick setting menu is provided for live view.
- The selected live view channel can be covered.
- Motion detection, tamper-proof, video exception and video loss alarm functions.
- Privacy mask.
- Multiple PTZ protocols supported; setting and calling of PTZ preset, patrol and pattern.
- Zooming in by clicking the mouse and PTZ tracing by dragging mouse.

HDD Management

- 1 SATA hard disk can be connected to the ALIEN654 and ALIEN674; 2 SATA hard disks to the ALIEN658, ALIEN666 and ALIEN678; 8 SATA hard disks to the ALIEN916 without DVD writer or 4 with writer and all with a maximum of 4TB storage capacity for each disk.
- 8 network disks (8 NAS disks, or 7 NAS disks+1 IP SAN disk) can be connected.
- HDD group management.
- Support HDD standby function.
- HDD property: redundancy, read-only, read/write (R/W).
- HDD quota management; different capacity can be assigned to different channels.

Recording and Playback

- Holiday recording schedule configuration.
- Normal and event video encoding parameters.
- Multiple recording types: manual, normal, motion, alarm, motion/alarm and motion & alarm.
- 8 recording time periods with separated recording types.
- Pre- and post-record for motion detection and pre-record time for schedule and manual recording.

- Searching record files by event.
- Customisation of tags, searching and playing back by tags.
- Locking and unlocking record files.
- Local redundant recording.
- Searching and playing back record files by channel number, recording type, start time, end time, etc.
- Smart search for the selected area in the video.
- Zooming in when playback.
- Playing in reverse.
- 1/4/8/16-ch synchronous playback at up to 4CIF resolution on standard model
2 channel synchronous real time playback at 1080P HD models.
- Support pause, speed up, speed down, skip forward, and skip backward when in playback, locating by dragging the mouse.

Backup

- Export video data by USB disk.
- Export video clips when playback.
- Management and maintenance of backup devices.

Alarm and Exception

- Alarm for video loss, motion detection, tampering, abnormal signal, video input/output standard mismatch, illegal login, network disconnected, IP confliction, abnormal record, HDD error, and HDD full, etc.
- Alarm event triggers full screen monitoring, audio alarm, notifying surveillance centre and Email.
- Automatic restore when system is abnormal.

Other Local Functions

- Operable by mouse, or IR remote control.
- Three-level user management; admin user is allowed to create many operating accounts and define their operating permission, which includes the limit to access any channel.
- Operation, exceptions and log recording and searching.
- Import and export of device configuration information.

Network Functions

- 1 self-adaptive 10M/100M network interface. 2 self adaptive network cards for ALIEN916
- IPv6 is supported.
- TCP/IP protocol, PPPoE, DHCP, DNS, DDNS, NTP, SADP, SMTP, UPnP™.
- TCP, UDP and RTP for unicast.
- Remote search, playback, download, locking and unlocking of the record files, and resume downloading partial files.
- Remote parameters setup; remote import/export of device parameters.
- Remote viewing of the device status, system logs and alarm status.
- Remote locking and unlocking of control panel and mouse.
- Remote HDD formatting and program upgrading.
- Remote system restart.
- RS-232 and RS-485 transparent channel transmission.
- Alarm event and exception information can be sent to the remote host.
- Remotely start/stop recording.
- Remote PTZ control.
- Two-way audio and voice broadcasting.
- Embedded WEB server.

TABLE OF CONTENTS

Regulatory Information	2
Preventive and Cautionary Tips	3
Product Key Features	4
Table of Contents	6
1. Introduction	9
1.1 Front Panel	9
1.2 IR Remote Control Operations	12
1.3 USB Mouse Operation	13
1.4 Input Method Description	14
1.5 Rear Panel	15
1.5.1 The rear panel of Alien654	15
1.5.2 The rear panel of Alien658	16
1.5.3 The rear panel of Alien666	17
1.5.4 The rear panel of Alien674 (HD)	18
1.5.5 The rear panel of Alien678 (HD)	19
1.5.6 The rear panel of Alien916 (HD)	20
1.6 Starting Up and Shutting Down the Device	21
2. Using the Smart Setup for Basic Configuration	22
3. Live View	25
3.1 Live View Icons	25
3.2 Operations in Live View Mode	25
3.2.1 Front Panel Operation	26
3.2.2 Using the Mouse in Live View	26
3.2.3 Using an Auxilliary Monitor	27
3.2.4 Main/Aux Output Switching	27
3.2.5 Quick Setting Toolbar in Live View Mode	28
3.3 Adjust Live View Settings	31
3.3.1 Live View – General	31
3.3.2 Live View – View	32
3.3.3 Live View - View (Alien 8/16 channel models)	32
3.4 Channel Zero Encoding	33
3.5 User Logout	34
4. PTZ Controls	30
4.1 Configuring PTZ Settings	35
4.2 Setting PTZ Presets, Patrols & Patterns	35
4.2.1 Customising Presets	35
4.2.2 Calling Presets	36
4.2.3 Customising Patrols	37
4.2.4 Calling Patrols`	39
4.2.5 Customising Patterns	40
4.2.6 Calling Patterns	40
4.3 PTZ Control Bar	41
5. Record Settings	43
5.1 Configuring Encoding Parameters	43
5.2 Setting Encoding Parameters for Main Stream	44
5.3 Setting Encoding Parameters for Sub Stream	45
5.4 Configuring Schedule Record	47

5.5	Configuring Motion Detection Record	50
5.6	Configuring Alarm Triggered Record	53
5.7	Instant Record	55
5.8	Configuring Holiday Record	56
5.9	Configuring Redundant Recording	57
5.10	Configuring HDD Group for Recording	58
5.11	File Protection	59
6.	Playback	62
6.1	Playing Back by Channel	62
6.2	Playing Back by Time	64
6.3	Playing Back by Normal Video Search	66
6.4	Playing Back by Event Search	68
6.5	Playing Back by Tag	71
6.6	Playing Back by System Log	74
6.7	Playing Back Frame by Frame	75
6.8	Instant Detective	75
6.9	Digital Zoom	78
7.	Backup	80
7.1	Quick Export	80
7.2	Backing Up by Normal Video Search	82
7.3	Backing Up by Event Search (Motion) only	84
7.4	Backing Up Video Clips	87
7.6	Managing Backup Devices	89
8.	Event Settings	92
8.1	Motion Detection	92
8.2	Setting Up Alarms	94
8.3	Detecting Video Loss	95
8.4	Detecting Video Tampering	97
8.5	Error Exception Reporting	99
8.6	Setting Alarm Response Actions	99
8.7	Triggering or Clearing Alarm Output Manually	101
9.	Network Settings	103
9.1	General Settings	103
9.2	Configuring PPPoE Settings	103
9.3	Configuring DDNS	104
9.4	Configuring NTP Server	107
9.5	Configuring SNMP	108
9.6	Configuring UPnP (Universal Plug & Play)	109
9.7	Configuring Remote Alarm Host	110
9.8	Configuring Multicast	110
9.9	Configuring RTSP	111
9.10	Configuring Server and HTTP Ports	111
9.11	Configuring Email	112
9.12	Checking Network Traffic	114
9.13	Testing Network Delay and Packet Loss	114
9.14	Exporting Network Packet	115
9.15	Checking Network Statistics	116
10.	HDD Management	117
10.1	Initialising/Formatting HDDs	117
10.2	Managing Network HDD	118

10.3	Setting HDD Groups	120
10.4	Setting HDD Property	121
10.5	Configuring Quota Mode	122
10.6	Checking HDD Status	123
10.7	Checking S.M.A.R.T Information	124
10.8	Detecting Bad Sector	124
10.9	Configuring HDD Error Alarms	125
11.	Camera Settings	126
11.1	Configuring OSD Settings	126
11.2	Configuring Privacy Mask	127
11.3	Configuring Video Parameters	128
12.	Device Management and Maintenance	130
12.1	Viewing Device Information	130
12.2	Viewing Camera Information	130
12.3	Viewing Record Information	131
12.4	Viewing Alarm Information	131
12.5	Viewing Network Information	132
12.6	Viewing HDD Information	132
12.7	Searching and Exporting Log Files	133
12.8	Importing/Exporting Configuration Files	134
12.9	Restoring Default Settings	135
13.	Upgrading the Firmware	136
13.1	Upgrading by Local Backup Device	136
13.2	Upgrading by FTP	136
14.	Configuring Other Settings	138
14.1	Configuring General Settings	138
14.2	Configuring RS232 Serial Port	139
14.3	Configuring DST Settings	139
14.4	General More Settings	140
15.	Managing User Accounts	141
15.1	Adding a User	141
15.2	Deleting a User	144
15.3	Editing a User	144
15.4	Changing Password of Admin	145
15.5	Logging off / Shutting down / Rebooting DVR	146
16.	Glossary	147
17.	Frequently Asked Questions	148
18.	Record Timings	149
18.1	Record Timings for 16 channels – Alien666	149
18.2	Record Timings for 8 channels – Alien658	150
18.3	Record Timings for 4 channels – Alien654	151
18.4	Record Timings for 16 channels – Alien916 HD Model	152
18.5	Record Timings for 8 channels – Alien678 HD Model	153
18.6	Record Timings for 4 channels – Alien674 HD Model	154
19.	Frame Rate Settings for Alien Hero	155
20.	Technical Data Sheet	156

1. Introduction

1.1 Front Panel

1.1.1 The front panel of the ALIEN654

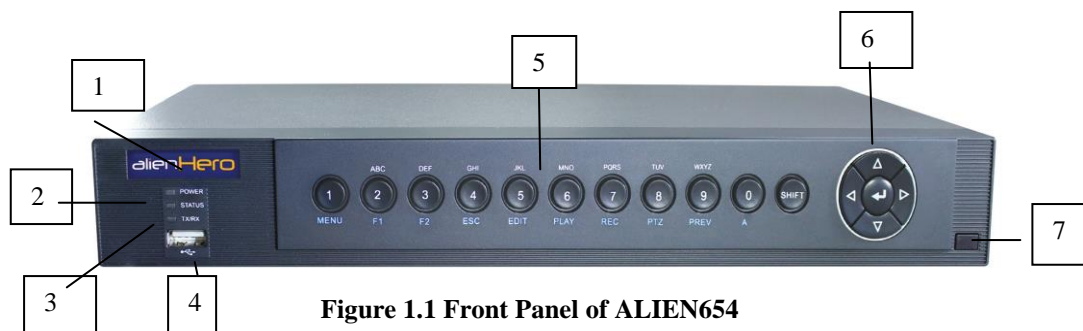

Figure 1.1 Front Panel of ALIEN654

Table 1.1 Description of Control Panel Buttons

No.	Name	Function Description
1	Power	Power indicator turns green when powered on.
2	Status	Indicator turns green when DVR is controlled by an IR remote control with the address from 1~254; Indicator turns red when the SHIFT button is used; Indicator does not light when the DVR is controlled by a keyboard or by the IR remote control with the address of 255; Indicator turns green when the DVR is controlled by IR remote control (with the address from 1~254) and keyboard at the same time , and the SHIFT button is not used; Indicator turns orange : (a) when the DVR is controlled by IR remote control (with the address from 1~254) and keyboard at the same time and the SHIFT button is used as well; (b) when the DVR is controlled by IR remote control (with the address from 1~254) and the SHIFT button is used.
3	Tx/Rx	Indicator blinks green when network connection is running
4	USB interface	USB for mouse or memory stick.
5	1/MENU	Enter numeral “1”; Access the main menu interface.
	2ABC/F1	Enter numeral “2”; Enter letters “ABC”; The F1 button can be used to select all items on the list; In PTZ Control mode, the F1 button can be used to zoom out (zoom-) the PTZ camera; In live view or playback mode, the F1 button can be used to switch between main and spot video output.

	3DEF/F2	<p>Enter numeral “3”;</p> <p>Enter letters “DEF”;</p> <p>In PTZ Control mode, the F1 button can be used to zoom in (zoom+) the PTZ camera;</p> <p>The F2 button can be used to cycle through tab pages.</p>
5	4GHI/ESC	<p>Enter numeral “4”;</p> <p>Enter letters “GHI”;</p> <p>Exit and back to the previous menu.</p>
	5JKL/EDIT	<p>Enter numeral “5”;</p> <p>Enter letters “JKL”;</p> <p>Delete characters before cursor;</p> <p>Select the checkbox and ON/OFF switch;</p> <p>Start/stop record clipping in playback.</p>
	SHIFT	Switch of compound keys between the numeric/letter input and functional control.
	6MNO/PLAY	<p>Enter numeral “6”;</p> <p>Enter letters “MNO”;</p> <p>In Playback mode, it is used for direct access to playback interface.</p>
	7PQRS/REC	<p>Enter numeral “7”;</p> <p>Enter letters “PQRS”;</p> <p>Manual record, for direct access to manual record interface; manually enable/disable record.</p>
	8TUV/PTZ	<p>Enter numeral “8”;</p> <p>Enter letters “TUV”;</p> <p>Access PTZ control interface.</p>
	9WXYZ/PREV	<p>Enter numeral “9”;</p> <p>Enter letters “WXYZ”;</p> <p>Multi-camera display in live view;</p> <p>In Playback mode or Menu→Playback→Tag playback interface, this button can be used to delete the selected tag.</p>
	0/A	<p>Enter numeral “0”;</p> <p>Switch between input methods (upper and lowercase alphabet, symbols and numeric input).</p> <p>In Playback mode, this button can be used to add the default tag.</p>
	SHIFT	Switch of compound keys between the numeric/letter input and functional control.
6	DIRECTION	<p>The DIRECTION buttons are used to navigate between different fields and items in menus.</p> <p>In Playback mode, the Up and Down button is used to speed up and slow down recorded video.</p> <p>In All-day Playback mode, the Left/Right button can be used to select the recorded video of next/previous day; in Playback by Normal Video Search, the Left/Right button can be used to select the next/previous recorded file.</p> <p>In Live View mode, the directional buttons can be used to cycle through channels.</p> <p>In PTZ control mode, it can control the movement of the PTZ camera.</p>

	ENTER	<p>Confirm selection in any of the menu modes. It can also be used to tick checkbox fields.</p> <p>In Playback mode, it can be used to play or pause the video.</p> <p>In Single-frame Playback mode, pressing the ENTER button will advance the video by a single frame.</p> <p>In Auto-switch mode, it can be used to stop /start auto switch.</p>
7	IR Receiver	Receiver for IR remote.

1.1.2 The front panel of the ALIEN678



Figure 1. 1 Front Panel of ALIEN678

Table 1. 1 Description of Front Panel

No.	Name	Function Description
1	POWER	Power indicator turns yellow when power switch on the rear panel is turned on.
	STATUS	Status indicator blinks red when data is being read from or written to HDD.
	TX/RX	TX/RX indicator blinks yellow when network connection is functioning properly.
2	IR Receiver	Receiver for IR remote
3	USB Interfaces	Universal Serial Bus (USB) ports for additional devices such as USB mouse and USB Hard Disk Drive (HDD).

1.2 IR Remote Control Operations

The device may also be controlled with the included IR remote control, shown in Figure 1.3.

Note: Batteries (2×AAA) must be installed before operation.

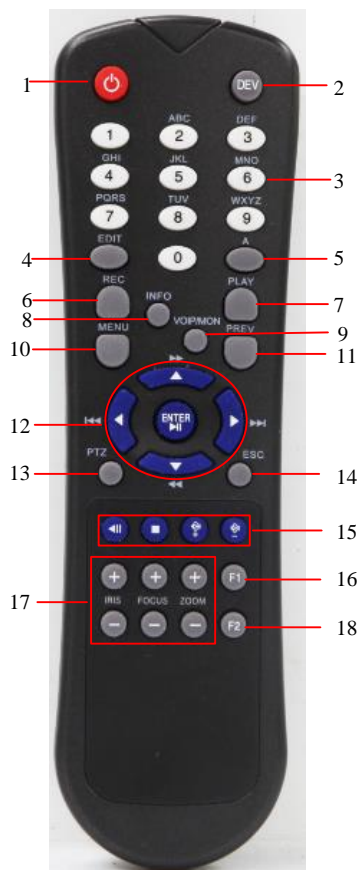

Figure 1.2 Remote Control

Table 1.2 Description of the IR Remote Control Buttons

No.	Name	Description
1	POWER	Power on/off the device.
2	DEV	Enables/Disables Remote Control.
3	Alphanumeric Buttons:	Switching to the corresponding channel in Live view or PTZ Control mode. Inputting numbers and characters in Edit mode. Switching between different channels in All-day Playback mode.
4	EDIT Button	Editing text fields. When editing text fields, it will also function as a Backspace button to delete the character in front of the cursor. On checkbox fields, pressing the EDIT button will <i>tick</i> the checkbox. In Playback mode, it can be used to generate video clips for backup.
5	A Button	Switching between input methods (upper and lowercase alphabet, symbols and numeric input).
6	REC Button	Entering the Manual Record settings menu. In PTZ control settings, press the REC button and then you can call a PTZ preset by pressing Numeric button.
7	PLAY Button	Entering the All-day Playback menu.
8	INFO Button	Reserved.
9	VOIP/MON Button	Selecting all items on the list; In live view or playback mode, it can be used to switch between main and auxiliary video output.

No.	Name	Description
10	MENU Button	Back to the Main menu (after successful login).
11	PREV Button	Switching between single screen and multi-screen mode.
12	DIRECTION/ENTER Buttons	Navigating between different fields and items in menus. In Playback mode, the Up and Down button are used to speed up and slow down the playing of recorded video. The Left and Right button will select the recorded video of 30 reverse and 30s forward. In live view mode, these buttons can be used to cycle through channels.
13	PTZ Button	Enter the PTZ Control mode.
14	ESC Button	Back to the previous menu Pressing for arming/disarming the DVR in Live View mode.
15	RESERVED	Reserved.
16	F1 Button	Selecting all items on the list when used in a list field. In PTZ Control mode, it will turn on/off PTZ light.
17	PTZ Control Buttons	Adjusting the iris, focus and zoom of a PTZ camera.
18	F2 Button	Cycle through tab pages.

Troubleshooting Remote Control:

Note: Make sure you have installed batteries properly in the remote control. And you have to aim the remote control at the IR receiver on the front panel.

If there is no response after you press any button on the remote, follow the procedure below to troubleshoot.

Steps:

1. Go to Menu > Configuration > General > More Settings by operating the mouse.
2. Check and remember the device No. The default No. is 255. This device No. is valid for all the IR remote controls.
3. Press the DEV button on the remote control.
4. Enter the device No. from step 2.
5. Press the ENTER button on the remote.

If the remote control is operating properly, but there is still no response from the remote, please check the following:

1. Batteries are installed correctly and the polarities of the batteries are not reversed.
2. Batteries are not flat.
3. IR receiver on DVR is not obstructed.

1.3 USB Mouse Operation

A regular 3-button (Left/Right/Scroll-wheel) USB mouse can also be used with this device. To use a USB mouse:

1. Plug USB mouse into one of the USB interfaces on the front panel of the device.
2. The mouse should automatically be detected. If in a rare case that the mouse is not detected, the possible reason may be that the two devices are not compatible.

The operation of the mouse:

Table 1.3 Description of the Mouse Control

Name	Action	Description
Left-Click	Single-Click	Live view: Select channel and show the quick set menu. Menu: Select and enter.
	Double-Click	Live view: Switch single-screen and multi-screen.

	Click and Drag	PTZ control: pan, tilt and zoom. Tamper-proof, privacy mask and motion detection: Select target area. Digital zoom-in: Drag and select target area. Live view: Drag channel/time bar.
Right-Click	Single-Click	Live view: Show menu. Menu: Exit current menu to upper level menu.
Scroll-Wheel	Scrolling up	Live view: Previous screen. Right-click Menu: Previous item.
	Scrolling down	Live view: Next screen. Right-click Menu: Next item.

1.4 Input Method Description



Figure 1.2 Soft Keyboard

Description of the buttons on the soft keyboard:

Table 1.4 Description of the Soft Keyboard Icons

Icons	Description	Icons	Description
	English		Capital English
	Numbers		Symbols
	Lowercase/Uppercase		Backspace
	Space		Enter
	Exit		

1.5 Rear Panel

1.5.1 The rear panel of Alien654

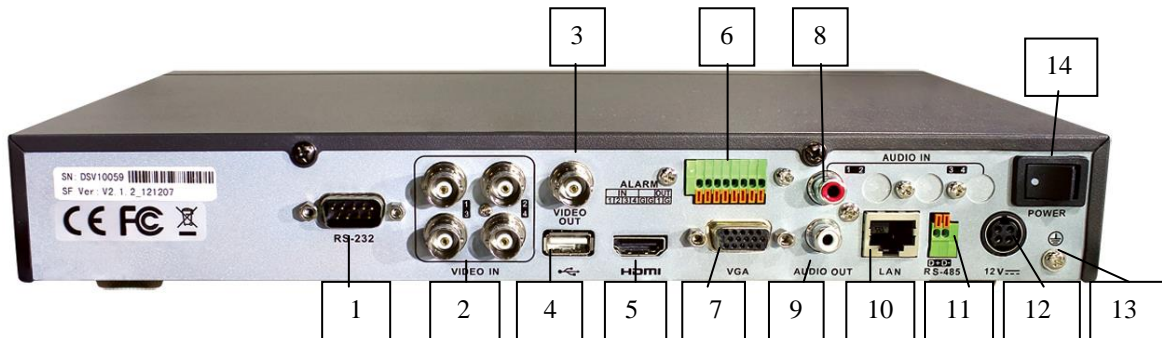

No.	Item	Description
1	RS232	Connector for RS232 devices
2	VIDEO IN	BNC connector for analogue video input.
3	VIDEO OUT	BNC connector for video output.
4	USB Interface	Connects USB mouse or USB flash memory devices.
5	HDMI	HDMI video output.
6	Alarm In/Out	Connection for alarm input/output.
7	VGA	DB15 connector for VGA output. Display local video output and menu.
8	AUDIO IN	RCA connector for audio input.
9	AUDIO OUT	RCA connector for audio output.
10	LAN Interface	Connector for LAN (Local Area Network).
11	RS-485 Interface	Connector for RS-485 devices. Connect the D+ and D- terminals to T+ and T- of PTZ receiver respectively.
12	12V	12VDC power supply.
13	GND	Ground(needs to be connected when DVR starts up).
14	POWER	Switch for turning on/off the device.

1.5.2 The rear panel of Alien658

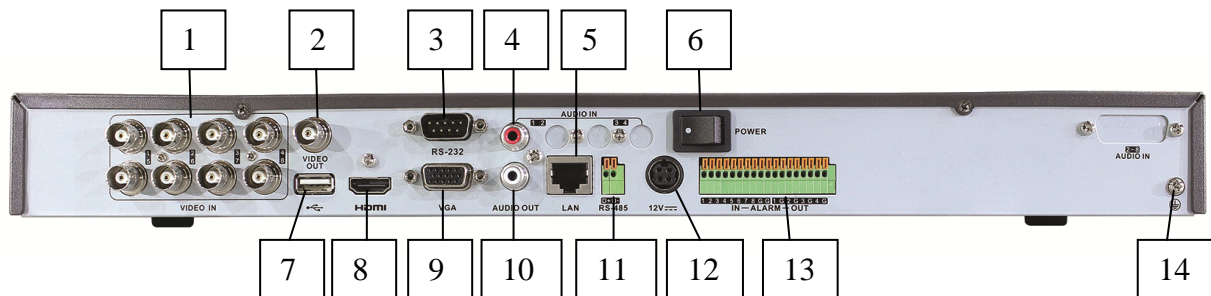

No.	Item	Description
1	VIDEO IN	BNC x 8 connectors for analogue video inputs.
2	VIDEO OUT	BNC x 1 connector for video output (main composite multi-channel)
3	RS232	Connector for RS232 devices
4	AUDIO IN	RCA connector for audio input.
5	LAN Interface	Connector for LAN (Local Area Network).
6	POWER	Switch for turning on/off the device.
7	USB Interface	Connects USB mouse or USB flash memory devices.
8	HDMI	HDMI video output.
9	VGA	DB15 connector for VGA output. Display local video output and menu.
10	AUDIO OUT	RCA connector for audio output.
11	RS-485 Interface	Connector for RS-485 devices. Connect the D+ and D- terminals to T+ and T- of PTZ receiver respectively.
12	12V	12VDC power supply.
13	Alarm In/Out	Connection for 8 x alarm inputs and 4 alarm outputs.
14	GND	Ground(needs to be connected when DVR starts up).

1.5.3 The rear panel of Alien666

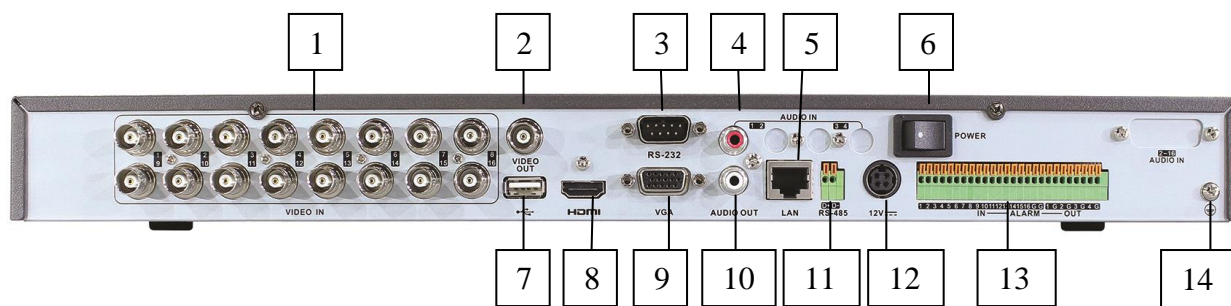

No.	Item	Description
1	VIDEO IN	BNC x 16 connectors for analogue video inputs.
2	VIDEO OUT	BNC x 1 connector for video output (main composite multi-channel)
3	RS232	Connector for RS232 devices
4	AUDIO IN	RCA connector for audio input.
5	LAN Interface	Connector for LAN (Local Area Network).
6	POWER	Switch for turning on/off the device.
7	USB Interface	Connects USB mouse or USB flash memory devices.
8	HDMI	HDMI video output.
9	VGA	DB15 connector for VGA output. Display local video output and menu.
10	AUDIO OUT	RCA connector for audio output.
11	RS-485 Interface	Connector for RS-485 devices. Connect the D+ and D- terminals to T+ and T- of PTZ receiver respectively.
12	12V	12VDC power supply.
13	Alarm In/Out	Connection for 16 x alarm inputs and 4 alarm outputs.
14	GND	Ground(needs to be connected when DVR starts up).

1.5.4 The rear panel of Alien674 (HD)

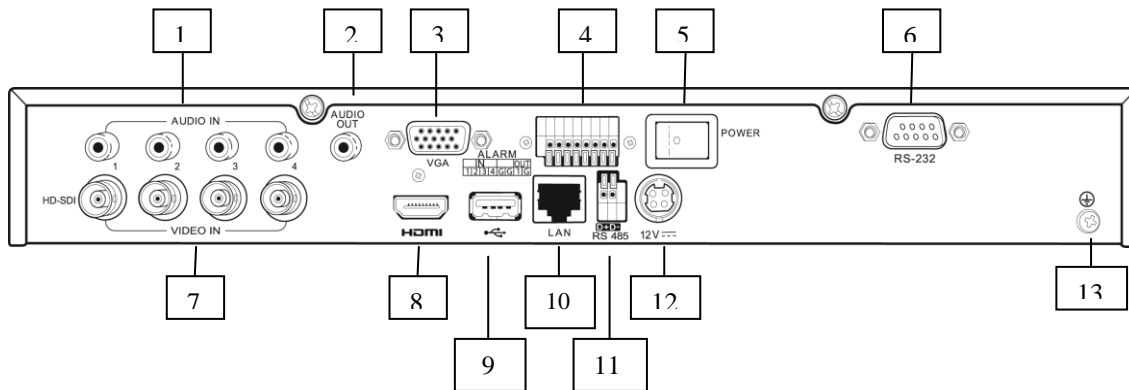

Table 1.5.4 Description of Rear Panel

No.	Item	Description
1	AUDIO IN	RCA connector for audio input x 4.
2	AUDIO OUT	RCA connector for audio output.
3	VGA	DB15 connector for VGA output. Display local video output and menu.
4	Alarm In/Out	Connection for alarm inputs x 4 and output alarm x 1
5	POWER	Switch for turning on/off the device.
6	RS232	Connector for RS232 devices
7	VIDEO IN	BNC connector for HDSI video inputs x 4
8	HDMI	HDMI video output.
9	USB Interface	Connects USB mouse or USB flash memory devices.
10	LAN Interface	Connector for LAN (Local Area Network).
11	RS-485 Interface	Connector for RS-485 devices. Connect the D+ and D- terminals to T+ and T- of PTZ receiver respectively.
12	12V	12VDC power supply.
13	GND	Ground(needs to be connected when DVR starts up).

1.5.5 The rear panel of Alien678 (HD)

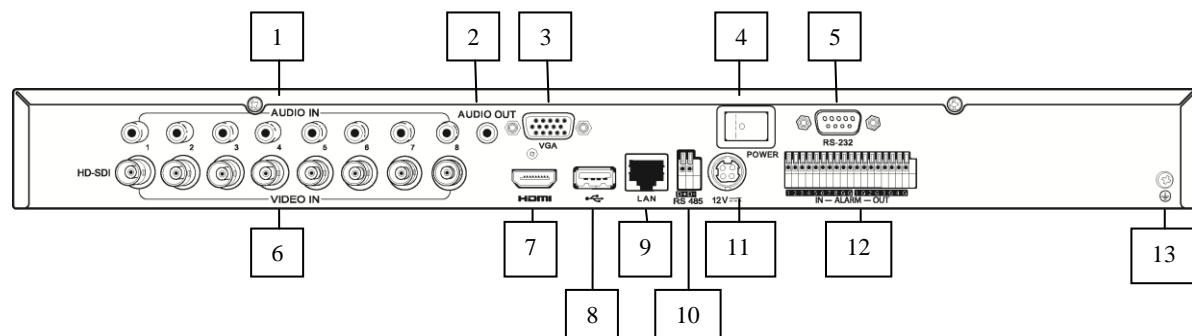
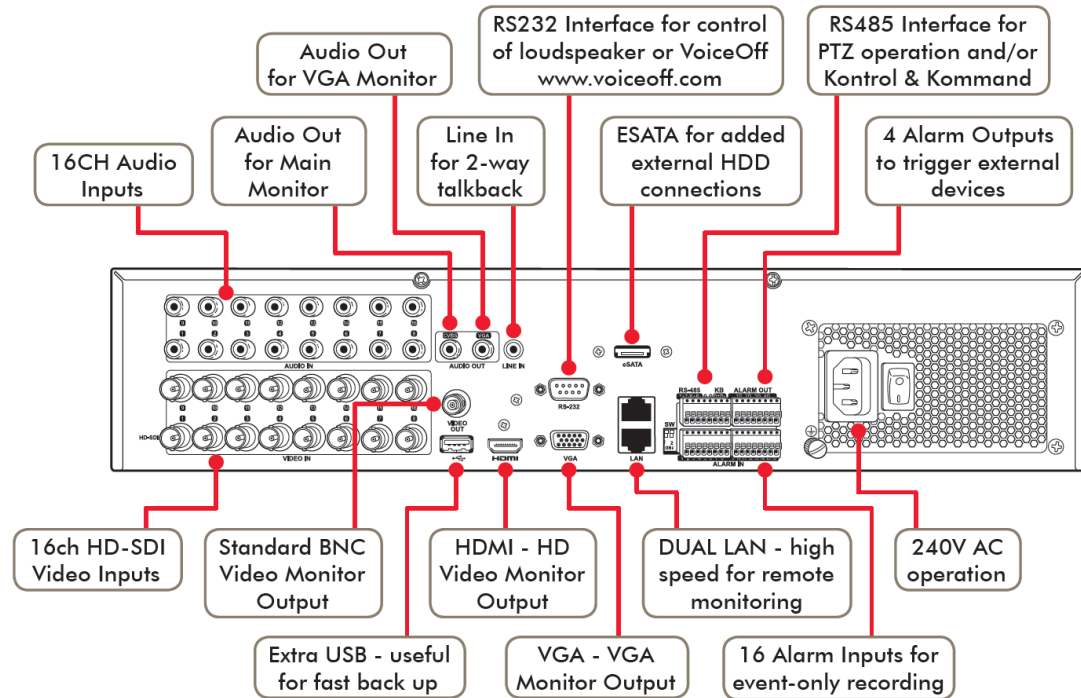

Table 1.5.4 Description of Rear Panel

No.	Item	Description
1	AUDIO IN	RCA connector for audio inputs x 8.
2	AUDIO OUT	RCA connector for audio output.
3	VGA	DB15 connector for VGA output. Display local video output and menu.
4	POWER	Switch for turning on/off the device.
5	RS232	Connector for RS232 devices
6	VIDEO IN	BNC connector for HDSI video inputs x 8
7	HDMI	HDMI video output.
8	USB Interface	Connects USB mouse or USB flash memory devices.
9	LAN Interface	Connector for LAN (Local Area Network).
10	RS-485 Interface	Connector for RS-485 devices. Connect the D+ and D- terminals to T+ and T- of PTZ receiver respectively.
11	12V	12VDC power supply.
12	Alarm In/Out	Connection for alarm inputs x 8 and output alarms x 4
13	GND	Ground(needs to be connected when DVR starts up).

1.5.6 The rear panel of Alien916 (HD)



1.6 Starting Up and Shutting Down the Device

Purpose:

Proper startup and shutdown procedures are crucial for extending the life of the device.

Starting up the device:

Steps:

Check the power lead is plugged into an electrical outlet providing the correct voltage for the DVR. It is **HIGHLY** recommended that an Uninterruptible Power Supply (UPS) be used in conjunction with the device. Press the **POWER** button on the front panel. The Power indicator LED on the front panel should be green, indicating the device is getting power.

Shutting down the device:

Steps:

To shut down the device:
Enter the Shutdown menu.

Menu > Turn Off



Figure 1.6 Shutdown Menu

Click the **Shutdown** button.

Click the **Yes** button.

Turn off the power switch on the rear of the DVR.

Rebooting the device

In the Shutdown menu you can also reboot the device.

Steps:

Enter the shutdown menu by clicking **Menu > Turn Off**.

Click the **Reboot** button to reboot the device.

2. Using the Smart Setup for Basic Configuration

By default, the Smart Setup starts once the device has loaded, as shown below. Note that it is recommended that if the unit has been setup and fitted with a hard drive/s then the Smart Setup can be cancelled and amendments made later.

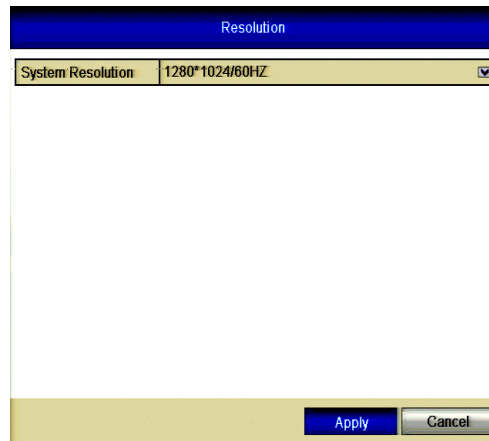

Operating the Smart Setup:

The Smart Setup can walk you through some important settings on the device. If you do not want to use the Smart Setup immediately, click the **Cancel** button. You can also choose to use the Smart Setup next time by leaving the "Start Smart Setup when DVR starts?" checkbox checked.

Click **Next** button on the Smart Setup window to enter the **Login** window, as shown in Figure 2c.



Figure 2b Smart Setup Interface

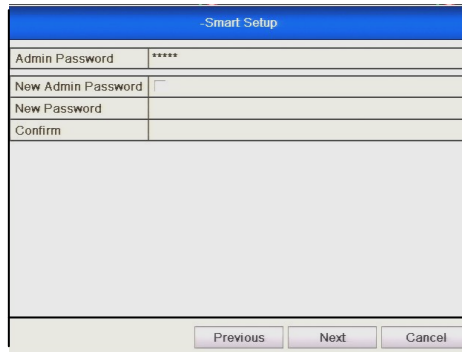

The image shows a 'Smart Setup' window with a blue header. It contains four input fields: 'Admin Password' (with masked characters '****'), 'New Admin Password', 'New Password', and 'Confirm'. At the bottom, there are three buttons: 'Previous', 'Next', and 'Cancel'.

Figure 2c Login Window

Enter the admin password. By default, the password is 12345. To change the admin password, check the **New Admin Password** checkbox. Enter the new password and confirm the password in the given fields. Click the **Next** button to enter the date and time settings window, as shown in Figure 2d.

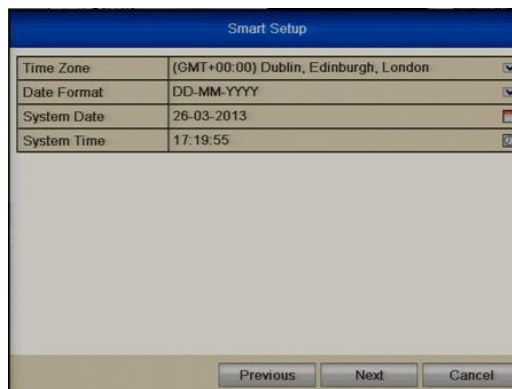

The image shows a 'Smart Setup' window with a blue header. It contains four rows of settings: 'Time Zone' (dropdown menu showing '(GMT+00:00) Dublin, Edinburgh, London'), 'Date Format' (dropdown menu showing 'DD-MM-YYYY'), 'System Date' (text field showing '26-03-2013'), and 'System Time' (text field showing '17:19:55'). At the bottom, there are three buttons: 'Previous', 'Next', and 'Cancel'.

Figure 2d Date and Time Settings

After the time settings, click **Next** button which takes you back to the Network Setup window, as shown in Figure 2e.

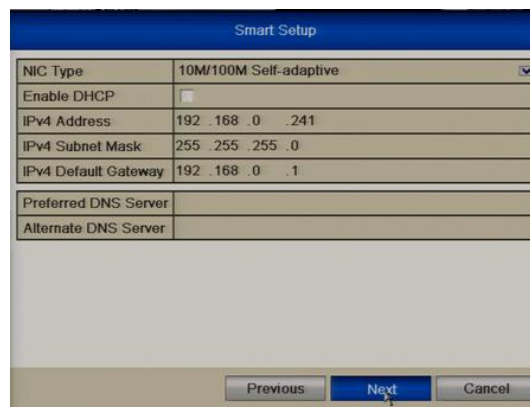

The image shows a 'Smart Setup' window with a blue header. It contains several rows of network settings: 'NIC Type' (dropdown menu showing '10M/100M Self-adaptive'), 'Enable DHCP' (checkbox), 'IPv4 Address' (text field showing '192 .168 .0 .241'), 'IPv4 Subnet Mask' (text field showing '255 .255 .255 .0'), 'IPv4 Default Gateway' (text field showing '192 .168 .0 .1'), 'Preferred DNS Server' (text field), and 'Alternate DNS Server' (text field). At the bottom, there are three buttons: 'Previous', 'Next', and 'Cancel'. The 'Next' button is highlighted in blue.

Figure 2e Network Configuration

Click **Next** button after you configured the network parameters, which takes you to the **HDD Management** window, shown in Figure 2f.

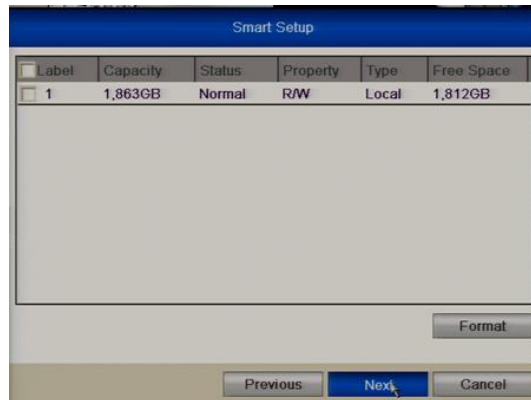

Figure 2f HDD Management

To initialise (format) the HDD, click the **Init** button. Initialisation removes all the data saved on the HDD.

Now click **Next** button to enter the **Record Settings** window, as shown below.

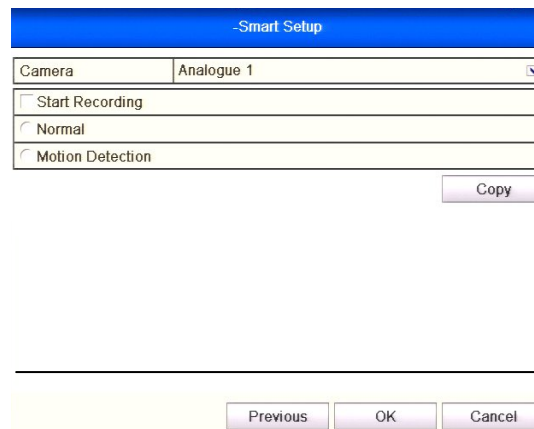

Figure 2g Record Settings

Click **Copy** to copy the settings to other channels, as shown in Figure 2h.

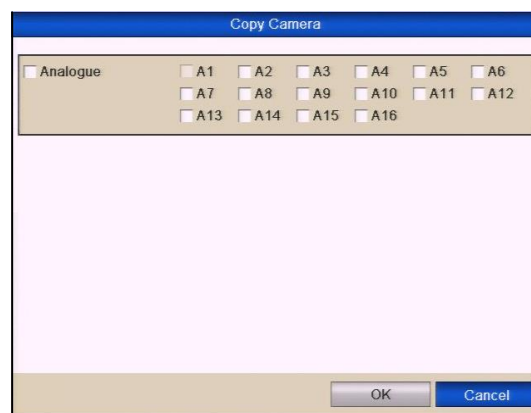

Figure 2h Copy Record Settings



3. Live View

Live view shows you the video image for each camera in real time. The device automatically enters Live View mode when powered up. It is also at the very top of the menu hierarchy, thus pressing the ESC button a number of times (depending on which menu you're on) always brings you the Live View mode.

3.1 Live View Icons

In the live view mode, there are icons at the top right of the screen for each channel showing the status of the record and alarm for each channel. This enables you to confirm when the unit is triggering an alarm/motion and whether the unit is recording for that channel.

Table 3.1 Description of Live View Icons

Icons	Description
	Alarm (video loss, tampering, motion detection or sensor alarm)
	Record (manual record, schedule record, motion detection or alarm triggered record)
	Alarm & Record

3.2 Operations in Live View Mode

There are many functions provided. The functions are listed below.

Single Screen: showing only one screen on the monitor.

Multi-screen: showing multiple screens on the monitor simultaneously.

Auto-switch: the screen is auto switched to display single or multiple screens. You must set the dwell time for each screen in the configuration menu before enabling Auto-switch.

Menu>Setup>Live View>General>Dwell Time

All-day Playback: play back the recorded videos for current day.

Start Recording: start all-day normal recording or motion detection recording for all channels.

Aux/Main output switch: the DVR will check the connection of the output interfaces to define the main and auxiliary output interfaces. When both HDMI and VGA are connected, or either one is connected, it is used as the auxiliary video output for live view, playback, recording and PTZ controls; When both HDMI and VGA are not connected, it is used as the main video output for live view playback, recording, PTZ control and menu operations.

When the aux output is enabled, you can do some basic operation on the live view mode for the Aux output, while no operation is allowed for the main output.

3.2.1 Front Panel Operation

Table 3.2.1 Front Panel Operation in Live View

Functions	Front Panel Operation
Show single screen	Press the corresponding Alphanumeric button. E.g. Press 2 to display only the screen for channel 2.
Show multi-screen	Press the PREV/FOCUS- button.
Manually switch screens	Next screen: right direction button. Previous screen: left direction button.
Auto-switch	Press Enter button.
All-day playback	Press Play button.
Switch between main and aux output	Press F1 button and the Enter button. This

3.2.2 Using the Mouse in Live View

In the live view mode, right click the mouse button on the window to see the Menu

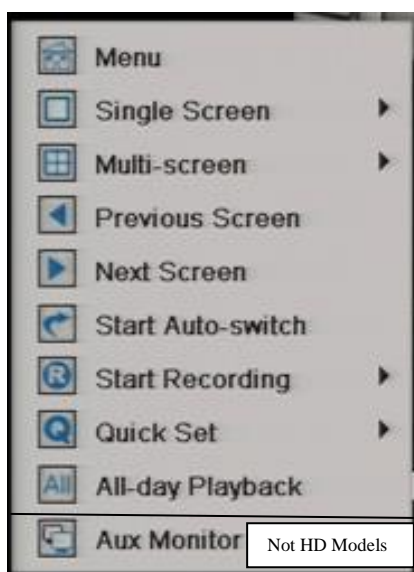

Name	Description
Menu	Enter the main menu of the system by right clicking the mouse.
Single Screen	Switch to the single full screen by choosing channel number from the dropdown list.
Multi-screen	Adjust the screen layout by choosing from the dropdown list.
Previous Screen	Switch to the previous screen.
Next Screen	Switch to the next screen.
Start/Stop Auto-switch	Enable/disable the auto sequencing of the screens.
Start Recording	Start all-day normal recording or motion detection recording for all channels.
Quick Set	Set the video output mode to Standard, Bright, Gentle or Vivid.
All-day Playback	Playback the video from the selected channel.
Aux Monitor	Switch to the auxiliary output mode and the operation for the main output is disabled. Note: If the AUX mode is entered but AUX monitor is not connected, the mouse operation is disabled and you will need to switch back to the main monitor output with the VOIP/MON button on IR remote and then press Enter button. (Not HD Models)

Table 3.2.2 Mouse Operation in Live View

If the corresponding camera supports the intelligent function, the Reboot Intelligence option is included when right-clicking mouse on this camera.

3.2.3 Using an Auxiliary Monitor (Not HD Models)

Certain features in the Live View are also available in the Aux monitor. These features include:

Single Screen:

Switch to a full screen display of the selected camera. Camera can be selected from a dropdown list.

Multi-screen:

Switch between different display layout options. Layout options can be selected from a dropdown list.

Previous Screen:

Switch to the previous screen.

Next Screen:

When displaying less than the maximum number of cameras in Live View, clicking this feature will switch to the next set of displays.

Quick Set:

Set the Video Output mode to Standard, Bright, Gentle or Vivid.

Menu Output Mode:

Select the menu output mode from HDMI/VGA, Main CVBS or Auto.

Main Monitor:

Switch to the Main Output mode and the operation for the auxiliary output is disabled.

Note: In the live view mode of the main output monitor, the menu operation is not available while Aux output mode is enabled.

3.2.4 Main/Aux Output Switching (Not HD Models)

When the HDMI/VGA output is configured as the main output, you can perform the following operation to switch to CVBS output as the main output.

Steps:

1. Use the mouse wheel to double-click on the HDMI/VGA output screen, and the following message box displays:

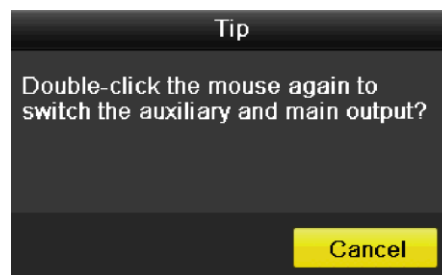

Figure 3.1.4a Switch Main and Aux Output

2. Use the mouse wheel to double-click on the screen again to switch to the Aux output, or click **Cancel** to cancel the operation.
3. Select the **Menu Output Mode** to **Main CVBS** from the right-click menu on the CVBS output monitor.

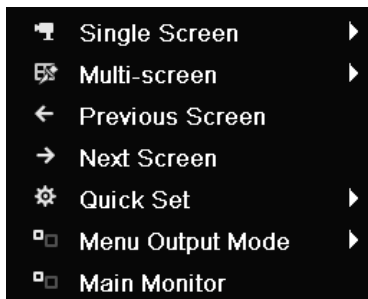

Figure 3.2.4b Right-click Menu on CVBS Output Monitor

4. In the display box, click **Yes** to restart the device to enable the CVBS output as the main output.

Note: You can select the Menu Output Mode under Menu>Configuration>More Settings to Auto or HDMI/VGA and then restart the device to switch the main output back to HDMI/VGA output.

3.2.5 Quick Setting Toolbar in Live View Mode

On the screen of each channel, there is a quick setting toolbar which shows when you right-click the mouse on the camera.

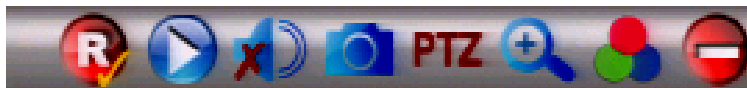

Figure 3.2.5a Quick Setting Toolbar

Table 3.2.5b Description of Quick Setting Toolbar Icons

Icons	Description	Icons	Description	Icons	Description
	Enable Manual Record		Instant Playback		Mute Audio
	Image Settings Not HD Models		PTZ Control		Digital Zoom
	Close				



Instant Playback only shows the recording of the last five minutes. If no recording is found, it means there is no recording during the last five minutes.



Digital Zoom can zoom in to the selected area of the full screen. You can left-click and draw to select the area for zooming in, as shown in Figure 3.2.5c.



Figure 3.2.5c Digital Zoom



Image Settings icon can be selected to enter the Image Settings menu. (Not HD Models)

Steps:

1. Set the period of a day for configuring independent image parameters so as to satisfy different light conditions, e.g., daylight and night time. Two periods can be configured. When you have configured Period 1, Period 2 remains as the *Other Time*. Note if period 1 is 00:00 – 24:00 period 2 cannot be set.
2. Select the mode from the drop-down menu according to different light conditions. Four modes are selectable:
 - **Standard:** in general lighting conditions (default).
 - **Indoor:** the image is relatively smoother.
 - **Dim Light:** the image is smoother than the other three modes.
 - **Outdoor:** the image is relatively clearer and sharper. The degree of contrast and saturation is high.



Figure 3.2.5d Image Settings

3. Adjust the image parameters including the brightness, contrast, saturation, hue, sharpness level and de-noising level by moving the slide bar or increasing/decreasing the value.

Note: The adjustable value range is 0~ 255 for the brightness, contrast, saturation and hue, 0~ 15 for the sharpness level and 0~5 for the de-noising level.
4. Copy image parameters.
 - 1) If you want to copy the image parameters of the current camera to other camera (s), click the **Copy** button to enter the **Copy to** interface:

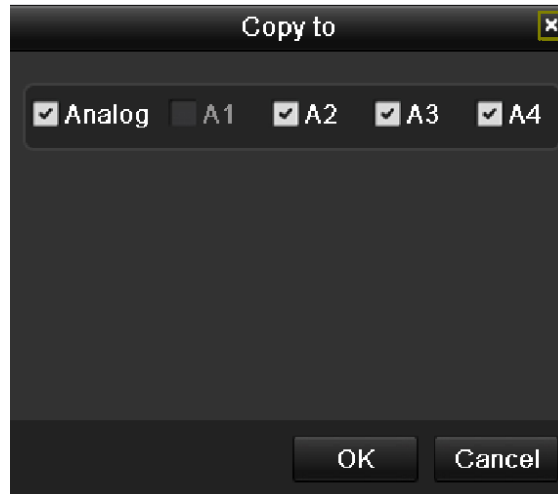

Figure 3.2.5e Copy Image Settings to Other Camera (s)

- 2) Select the camera(s) to be configured with the image settings. You can also click the Analogue checkbox to select all cameras.
 - 3) Click the **OK** button to finish the Copy settings.
- Note:** You can click the **Restore** button to restore the current image settings to default parameters.

3.3 Adjusting Live View Settings

3.3.1 Live View - General

Purpose:

Live View settings can be customised according to different needs. You can configure the output interface, dwell time for screen to be shown, mute or turning on the audio, the screen number for each channel, etc.

Enter the Live View Settings interface.

Menu> Setup> Live View

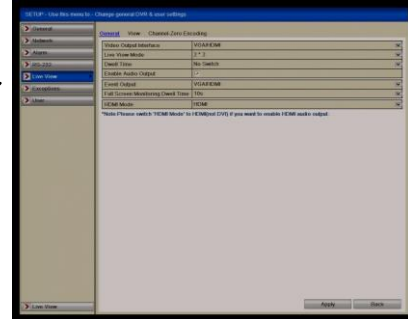

Figure 3.3.1 Live View-General

The settings available in this menu include:

Video Output Interface: Designates the output to configure the settings for. Two output interfaces are selectable: VGA/HDMI and Main CVBS for standard models and VGA/HDMI only for HD models.

Live View Mode: Select different window division mode from drop down list.

Dwell Time: The time in seconds to hold between switching of channels when enabling auto-switch in Live View.

Enable Audio Output: Enables/disables audio output for the selected video output.

Notes for standard models:

1. When the VGA/HDMI output interface is used as the main video output and the **Audio Output** for the VGA/HDMI output interface is enabled, the VGA/HDMI audio and AUDIO OUT can be used for live view, playback and two-way audio.
2. When the VGA/HDMI output is used as the main video output and the **Audio Output** for the VGA/HDMI output interface is disabled, the VGA/HDMI output provides no audio and the AUDIO OUT is used for two-way audio.
3. When the CVBS output is used as the main video output, the VGA/HDMI audio is provided for Aux video output in live view, and the AUDIO OUT is used as the main video output(for live view, playback or two-way audio).

Event Output: Designates the output to show event video.

Full Screen Monitoring Dwell Time: Time in seconds to show alarm event.



3.3.2 Live View – View

Setting Camera Order (Alien 4 channel model)

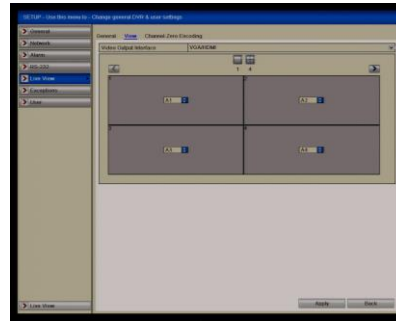
Figure 3.3.2 Live View- View



To set the camera order:

- 1) Click the **View** tab to enter the camera order settings interface.
- 2) Select an output interface and select a screen layout.
- 3) Use the centre up and down arrows to switch the channel to X in each channel you wish to change. Leaving the channel set at X will cover the camera picture. Otherwise set the required channel number ensuring no number is duplicated.
- 4) Note that if you wish to swap channel numbers you will need to set them to X first.
- 5) Click  or  to go to the previous or next page.
- 6) Click the **Apply** button to save the setting.

3.3.3 Live View – View

Setting Camera Order (Alien 8/16 channel models)

Figure 3.3.2 Live View- View

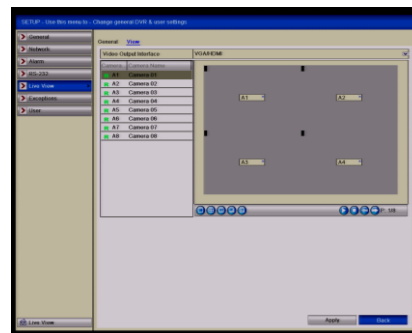

- 1) **Select View Tab.**
- 2) **Click a window to select it, and then double click a camera name in the list you would like to display. Setting an X means the window will not display any channel.**
- 3) **Click the Apply button.**

3.4 Channel Zero Encoding

Live View – Channel Zero Encoding only available on standard models – not HD

Sometimes you may need to get a remote view of many channels in real time from the web browser or client software using minimal bandwidth requirement without affecting the image quality. Channel-zero encoding is an option whereby a number of channels can be displayed within the confines of a single channel display without the overhead of a large network bandwidth.

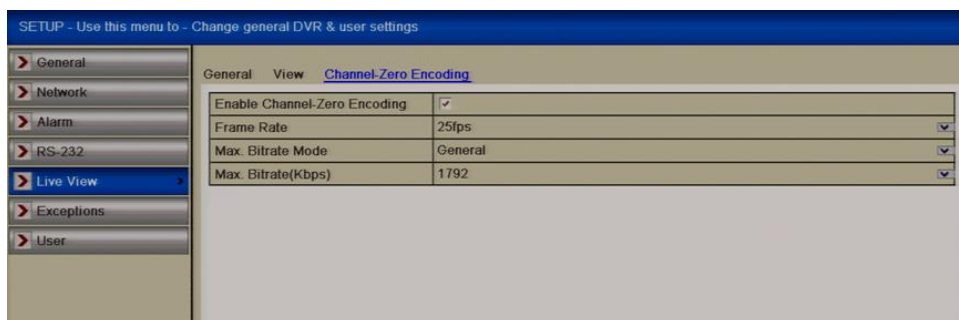

Figure 3.4 Channel Zero Encoding

Enter the **Live View** Settings interface.

Menu> Setup> Live View

Select the **Channel-Zero Encoding** tab.

Check the checkbox after **Enable Channel-Zero Encoding**.

Configure the Frame Rate, Max. Bitrate Mode and Max. Bitrate. After you set the Channel-Zero encoding, you can get a view in the remote client or IE browser of all the channels on one screen.

3.5 User Logout

Purpose:

After logging out, the monitor returns to the live view mode and if you want to do any operations, you will need to enter user name and password to log in again.

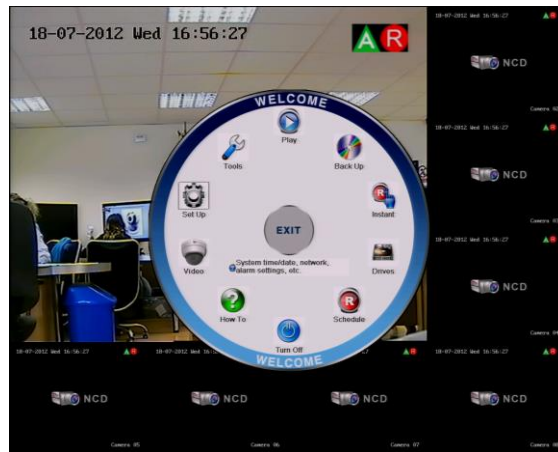

Enter the Turn Off menu.

Menu>Turn Off

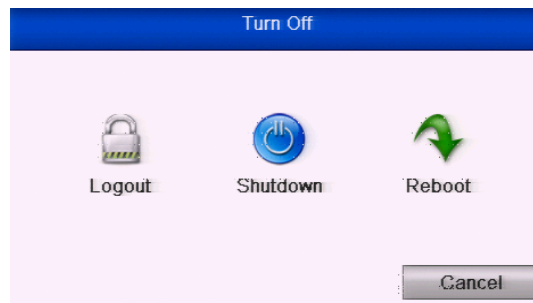

Figure 3.5 Turn Off

Click **Logout**.

Note: After you have logged out the system, menu operations on the screen are invalid. A user name and password is required to login on the system.

4. PTZ Controls

4.1 Configuring PTZ Settings

Purpose:

Follow the procedure to set the parameters for PTZ. The configuring of the PTZ parameters should be done before you attempt to control the PTZ camera.

Before you start:

Check that the PTZ and the DVR are connected properly through the RS-485 interface.

Steps:

Enter the PTZ Settings interface.

Menu > Video > PTZ

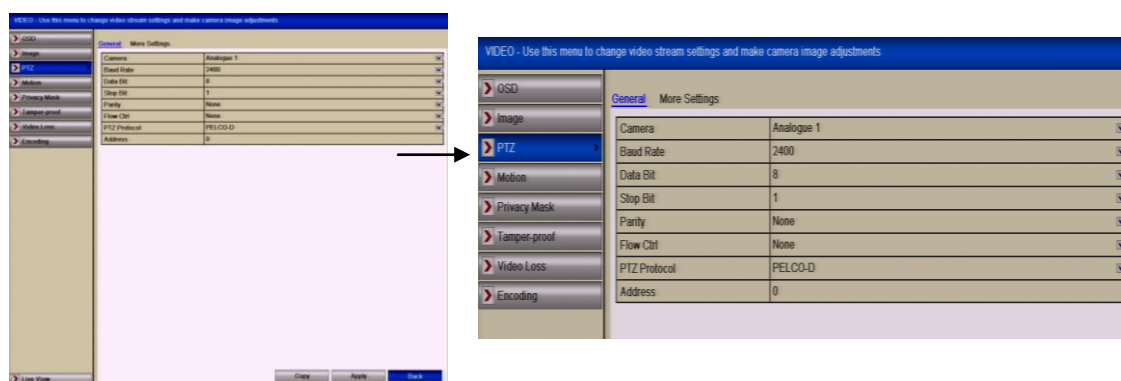

Figure 4.1 PTZ - General Menu

Choose the camera for PTZ setting in the **Camera** dropdown list.

Enter the parameters of the PTZ camera.

Note: All the parameters should be exactly the same as the PTZ camera parameters.

Example: If the PTZ camera has a Baud Rate of 2400, Protocol PELCO-D and Address or ID of 001 you should input these parameters in this menu.

Click **Copy** if you want to configure same settings to other PTZ cameras but change Ids as these must be unique.

Click **Apply** button to save the settings.

4.2 Setting PTZ Presets, Patrols & Patterns

Before you start:

Please make sure that the presets, patrols and patterns are supported by PTZ protocols.

4.2.1 Customising Presets

Purpose:

Follow the steps to set the Preset location which you want the PTZ camera to point to when an event takes place.

Steps:

Enter the PTZ Control interface.

Menu>Video>PTZ>More Settings



Figure 4.2.1a PTZ- More Settings

Use the direction button to move the camera to the location where you want to set the first preset.

Click the round icon before **Save Preset**.

Click the preset number to save the preset.

Repeat the steps to save more presets. If the number of the presets you want to save is more than 17, you can click on [...] and choose the available numbers.

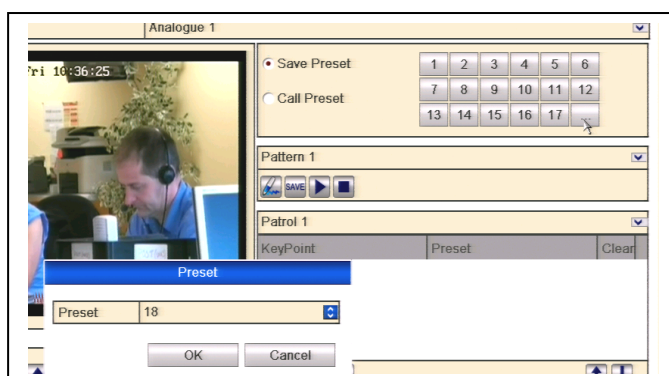

Figure 4.2.1b More Presets

4.2.2 Calling Presets

Purpose:

This feature enables the camera to point to a specified position such as a door when an event takes place.

Call preset in the PTZ setting interface:

Steps:

Enter the PTZ Control interface using **Menu>Video>PTZ>More Settings**

Check the round icon before **Call Preset**.

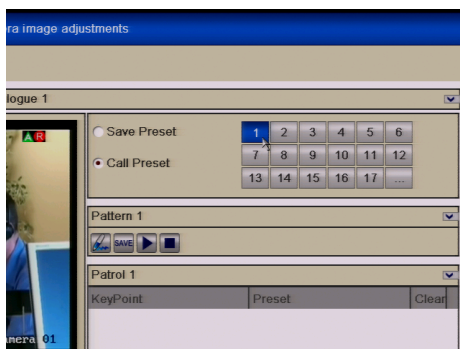



Figure 4.2.2a PTZ- Call Preset

Choose the preset number.

Call preset in live view mode:

Steps:

Press the PTZ button on the front panel or click the PTZ Control icon  in the quick setting bar to enter the PTZ setting menu in live view mode.

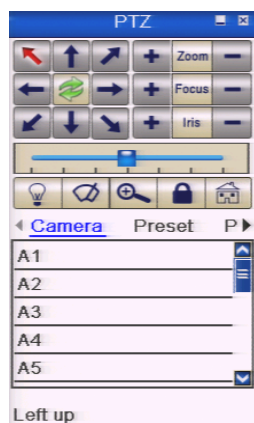

Figure 4.2.2b PTZ Toolbar

Choose **Camera** in the list on the menu.

Choose preset in the **Preset** list.

4.2.3 Customising Patrols

SPECIAL NOTE: To initiate a Patrol (Tour) refer to the respective PTZ camera menu instructions. In most cases Patrols are initiated using a Preset number.

Purpose:

Patrols can be set to move the PTZ to different preset points and have it stay there for a set duration before moving on to the next preset. The preset point is the order number that is used for the corresponding preset number. The presets can be set following the steps above in **Customising Presets**.

Steps:

Enter the PTZ Control interface using **Menu>Video>PTZ>More Settings**

Select patrol number.

Select the  under Patrol option box to add preset points for the patrol.

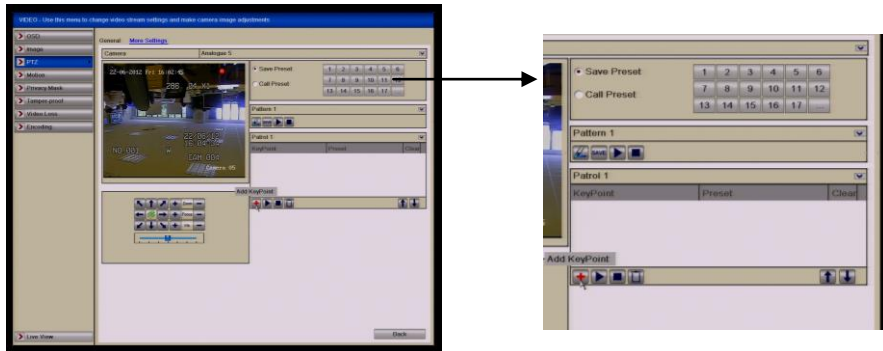

Figure 4.2.3a PTZ - Add Preset Key Point

Configure preset key point parameters, such as the key point No., duration of dwell time at preset and speed of patrol. The preset key point corresponds to a preset.

Key Point No. determines the order at which the PTZ will follow while cycling through the patrol.

Duration refers to the time-span it stays at the corresponding preset point.

Speed defines the speed at which the PTZ will move from one preset to the next.

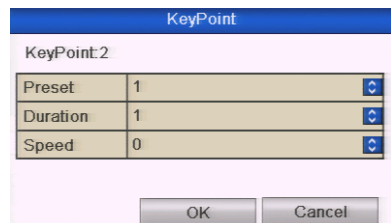

Figure 4.2.3b Key point Configuration

Click **OK** to save the key point to the patrol.

Repeat the above steps to add more key points.

You can also delete all the key points by clicking the trash icon

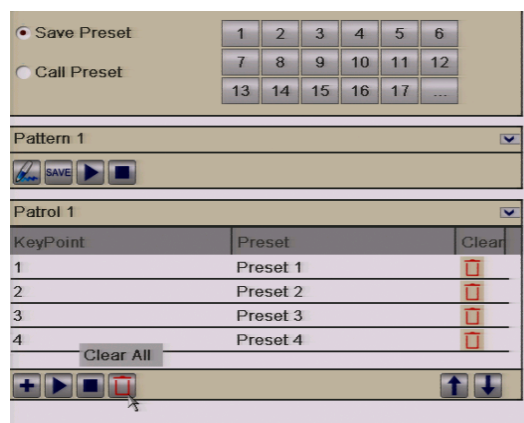

Figure 4.2.3c KeyPoints Deletion

4.2.4 Calling Patrols

Purpose:



Calling a patrol makes the PTZ move according to the predefined patrol path.

Calling patrol in the PTZ setting interface:

Steps:

In the PTZ setting interface.

Menu> Video> PTZ> More Settings

Select the patrol number, and then click  to call the patrol.
Click  to stop it.

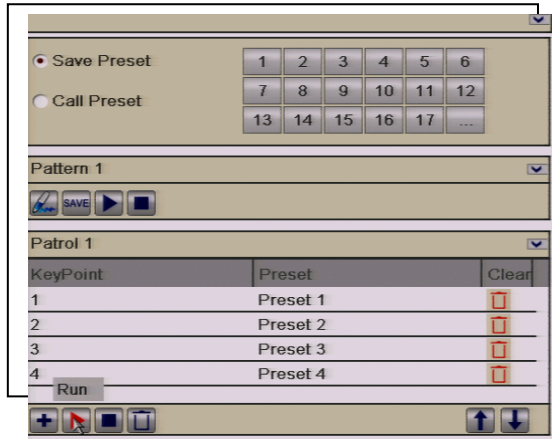



Figure 4.2.4a Calling Patrol

Calling preset in live view mode:

Steps:

Press PTZ control on the front panel or on the remote, or click PTZ Control icon  on the quick setting toolbar, to show the PTZ control toolbar.

Choose **Patrol** on the control bar.

Click the patrol you want to call.

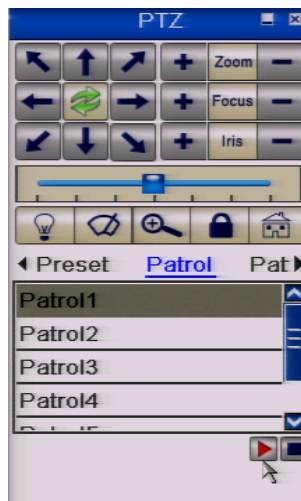

Figure 4.2.4b PTZ Toolbar - Patrol

4.2.5 Customising Patterns

Purpose:

Patterns can be set by recording the movement of the PTZ. You can call the pattern to make the PTZ replay movement according to the recorded pattern.

Steps:

Enter the PTZ Control interface.

Menu>Video>PTZ>More Settings

Choose pattern number in the option box.

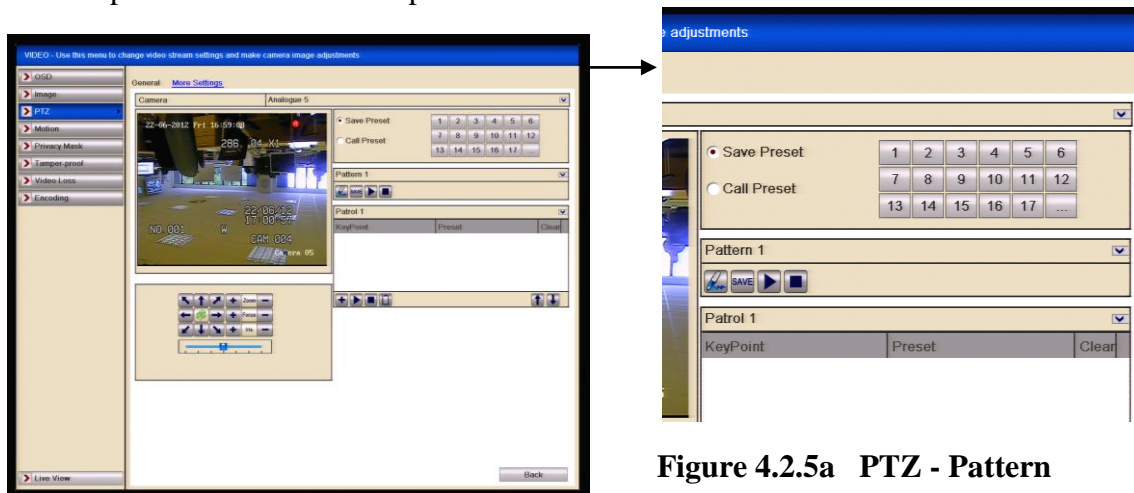



Figure 4.2.5a PTZ - Pattern

Click  and use your mouse to drag the image or click the eight directional buttons in the control box under the image to move the PTZ camera.

The movement of the PTZ is recorded as the pattern.

Click  to save the pattern.

Repeat the above steps to save more patterns.

4.2.6 Calling Patterns

Purpose:



Follow the procedure to move the PTZ camera according to the predefined patterns.

Calling pattern in the PTZ setting interface

Steps:

Enter the PTZ Control interface.

Select the pattern number.

Click  and the PTZ will move according to the pattern selected. Click  to stop.

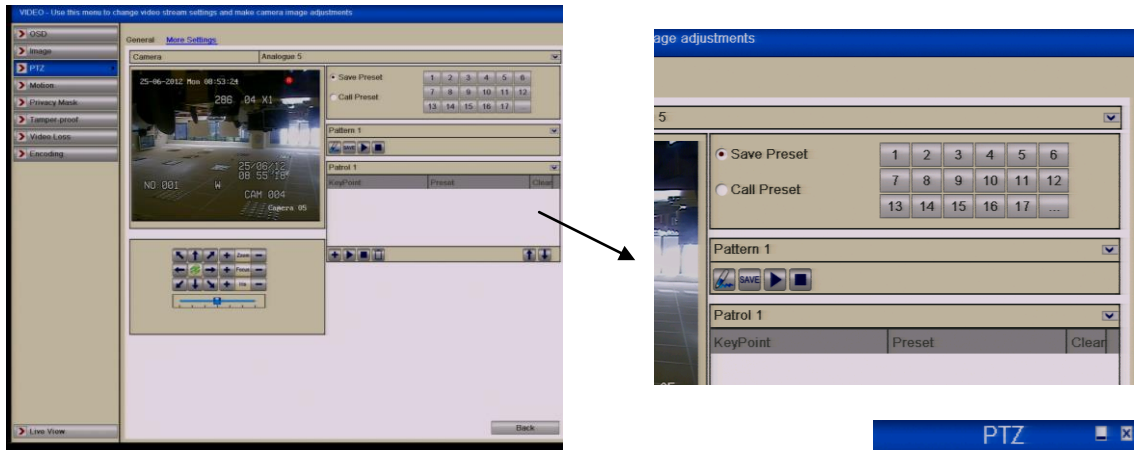



Figure 4.2.6a PTZ- Calling Pattern

Call pattern in live view mode.

Steps:

In the live view mode, press PTZ control on the front panel or on the remote control, or click PTZ Control icon  on the quick setting toolbar.

Then choose **Pattern** on the control bar.

Double click the pattern number you want to call, or you can select the pattern number and click  to call the pattern.

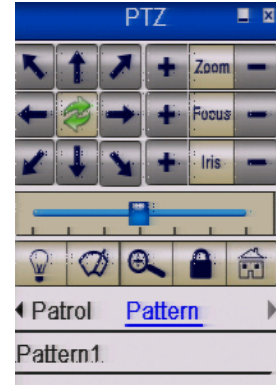

4.3 PTZ Control Toolbar

In the Live View mode, you can press the PTZ Control button on the front panel or on the remote control, or choose the PTZ Control icon  enter the PTZ toolbar.

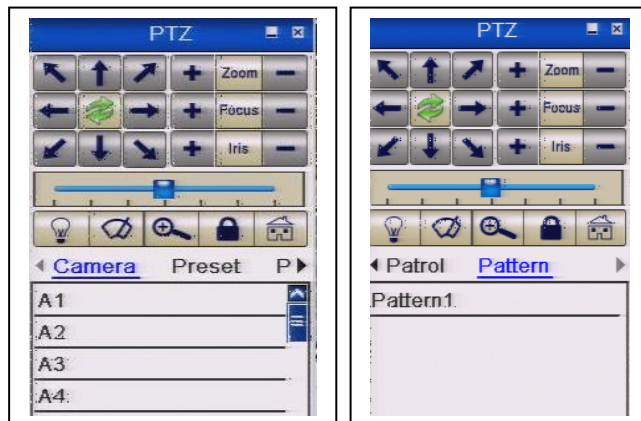



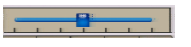

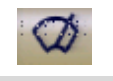









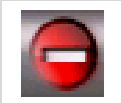



Figure 4.3a PTZ Toolbar

Table 4.3b Description of the PTZ toolbar icons

Icon	Description	Icon	Description	Icon	Description
	Direction button and the auto-cycle button		Zoom+, Focus+, Iris+		Zoom-, Focus-, Iris-
	The speed of the PTZ movement		Light on/off		Wiper on/off
	3D-Zoom		Lock Centrally		Preset
	Patrol		Pattern		Home Menu
	Previous item		Next item		Start pattern/patrol
	Stop the patrol or pattern movement		Minimise windows		Exit

5. Record and Capture Settings

5.1 Configuring Encoding Parameters

Purpose:

By configuring the encoding parameters you can define the transmission stream type, the resolution and so on.

Before you start:

Make sure that the HDD has already been installed. If not, please install a HDD and initialise it.

Menu>Drives>General

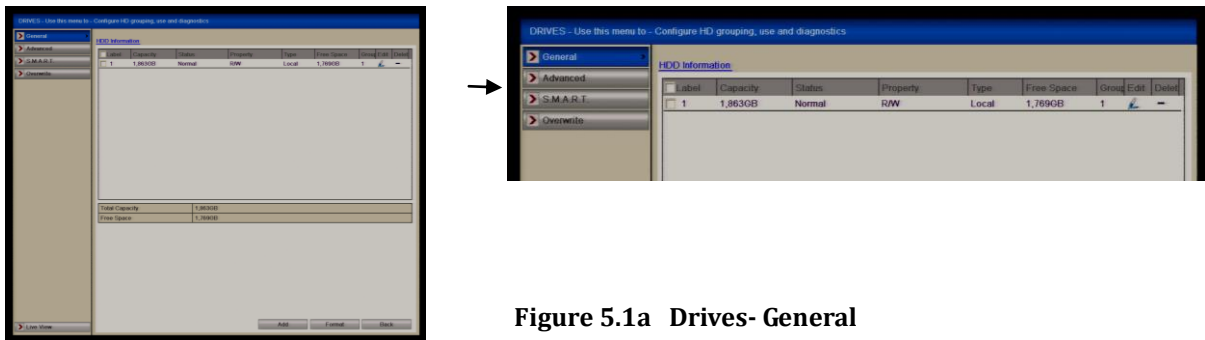

Figure 5.1a Drives- General

Checking the storage mode in the Drives Menu

Click **Advanced** to check the storage mode in the Drives menu.

If the HDD mode is **Quota**, you can set the maximum record capacity and maximum picture capacity. For detailed information, see **Chapter 10 - Configuring Quota Mode**.

If the HDD mode is **Group**, you can set the HDD group number. For detailed information, see **Chapter 5 - Configuring HDD Group for Recording**.

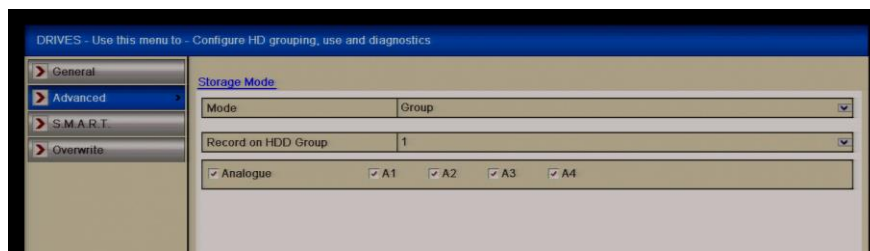

Figure 5.1b HDD- Advanced menu

Steps:

Enter the Record settings interface to configure the encoding parameters:

Menu>Video>Encoding

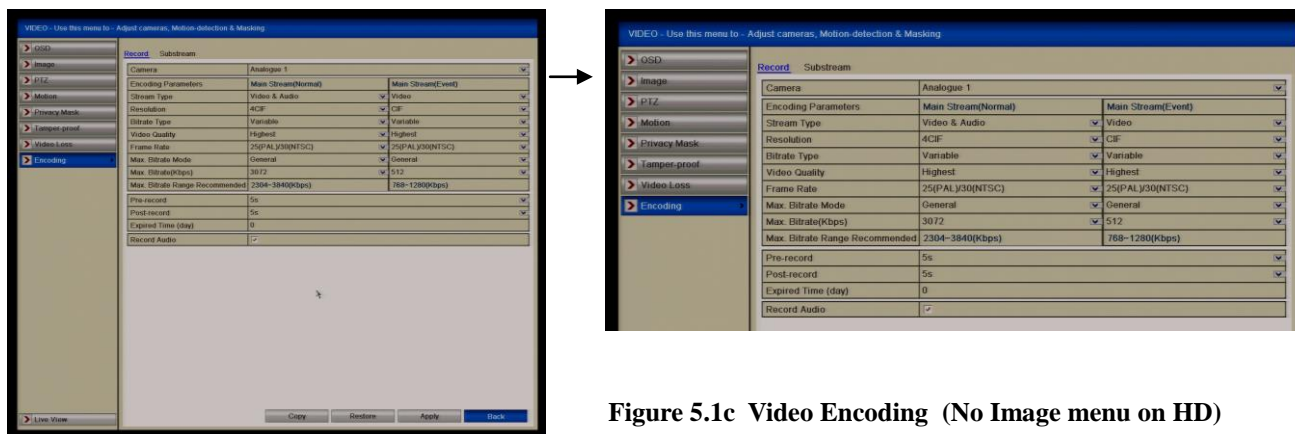

Figure 5.1c Video Encoding (No Image menu on HD)

5.2 Setting encoding parameters for main stream

- 1) Select **Record** to enter the main stream settings interface.
- 2) Select camera for configuration. HD models also display Input Resolution.

The Input Resolution of HD camera connected will be displayed in the live view for 5 seconds when the camera is connected or when DVR is first powered on. The display includes the resolution and the frame rate of the camera e.g 1080P25.

- 3) Configure the following parameters for the Main Stream (Normal) and the Main Stream (Event):
 - **Stream Type:** Set the stream type to be Video or Video & Audio.
 - **Resolution:** Set recording at resolution of 4CIF, 2CIF, CIF or QCIF.

On the HD models settings are 1080P, 720P, 4CIF, 2CIF & CIF.
 - **Bitrate Type:** Set the bitrate type to be Variable or Constant.
 - **Video Quality:** Set the video quality of recording, with 6 levels configurable.
 - **Frame Rate:** Set the frame rate of recording. (HD 1080P max 12FPS)
 - **Max. Bitrate Mode:** Set the mode to General or Customise (32-3072 or 16384) for HD.
 - **Max Bitrate (Kbps):** Select or customise the maximum bit rate for recording.
 - **Max. Bitrate Range Recommended:** A recommended Max. bitrate range is provided for reference.
- 4) Configure the pre-record, post-record time, expired time, redundant record (this option is only available when the HDD

mode is Group) and whether you want to record audio.

- **Pre-record:** The time you set to record before the scheduled time or event. For example, when an alarm triggered the recording at 10:00, if you set the pre-record time as 5 seconds, the camera records it at 9:59:55.
- **Post-record:** The time you set to record after the event or the scheduled time. For example, when an alarm triggered the recording ends at 11:00, if you set the post-record time as 5 seconds, it records till 11:00:05.
- **Expired Time (day):** The expired time is the longest time for a record file to be kept on the HDD, if the deadline is reached, the file will be deleted. You can set the expired time to 0, and then the file will not be deleted. The actual save time for the file will be determined by the capacity of the HDD.
- **Redundant Record:** Enabling redundant record means you save the record files in the redundant HDD. See Chapter 5 Configuring Redundant Record.

Note: The Redundant Record option is only available when the HDD mode is Group. The redundant record is to decide whether you want the camera to save the record files in the redundant HDD. You must configure the redundant HDD in HDD settings. For detailed information, see Chapter 10 Setting HDD Property.

- **Record Audio:** Check the checkbox to record the sound, or uncheck to record the image without sound.
- 5) If you want to copy the current main stream settings to other camera (s), click **Copy** to enter the Copy Camera interface. Select the camera (s) and click **OK** to finish the copy settings.

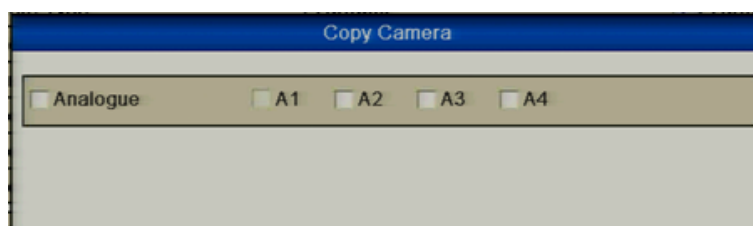

Figure 5.2 Copy Camera Settings

- 6) On the Record settings interface, click **Apply** to save the settings.

Note: You can click the **Restore** button to restore the current main stream settings to the default parameters.

5.3 Set encoding parameters for sub-stream

- 1) Click the **Substream** tab to enter the Substream settings interface

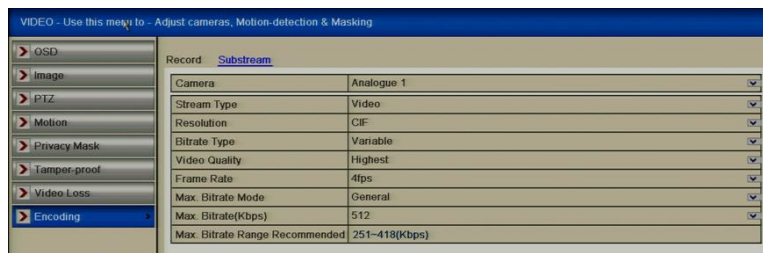

Figure 5.3a Encoding Parameters-Sub-stream

- 2) Configure the parameters for the sub-stream. Refer to the step of main stream settings.
- 3) Click **Apply** to save the settings.
Note: You can click the **Restore** button to restore the current sub-stream settings to the default parameters.
- 4) If you want to copy the current sub-stream settings to other camera (s), click **Copy** to enter the Copy Camera interface. Select the camera (s) and click **OK** to finish the copy settings.

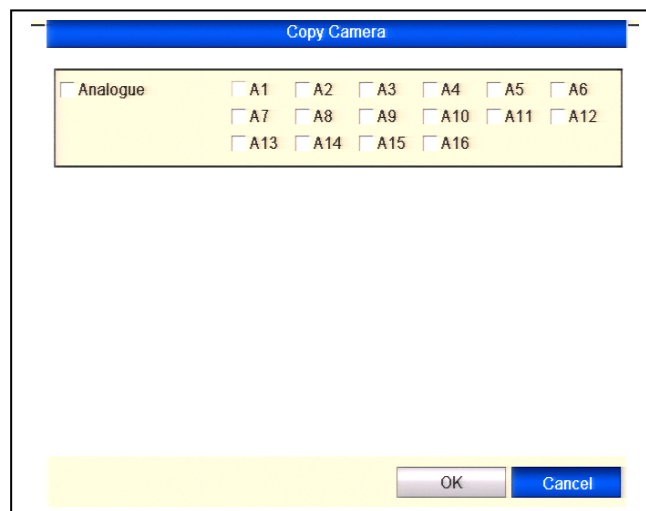

Figure 5.3b Copy Camera Settings

5.4 Configuring Schedule Record

Purpose:

Set the record schedule and the camera will automatically start/stop recording according to the configured schedule.

Steps:

Enter the Record Schedule interface.

Menu>Schedule>Schedule

Select Record.

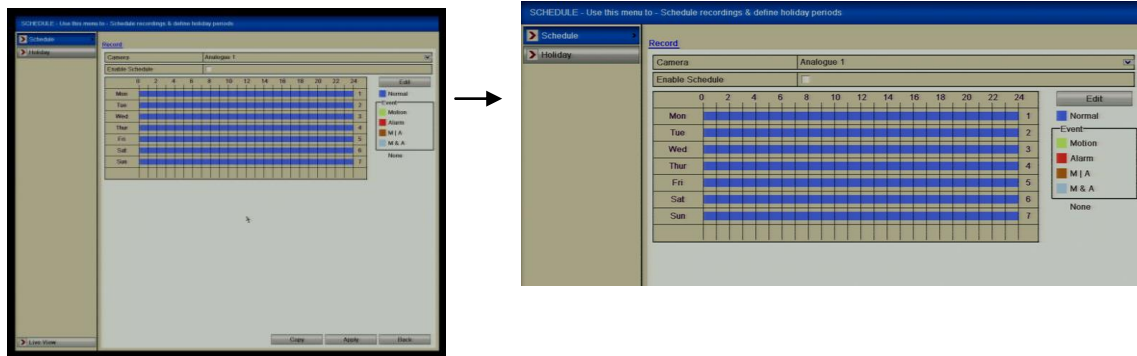

5.4a Record Schedule

Choose the camera you want to configure.

Select the check box after the **Enable Schedule** item.

There are two ways to set the recording schedule times.

Option 1 Using Edit function

Click **Edit**.

In the display box you can choose the day/s you want to set schedule.

To schedule an all-day recording, check the checkbox marked **All Day**.

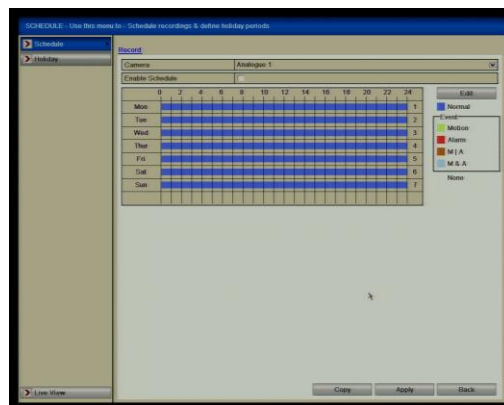

Figure 5.4b Edit Schedule

To set motion and or alarm, leave the **All Day** checkbox blank and set the Start/End times.

Note: Up to 8 periods can be configured for each day but time periods must run consecutively and must not overlap. Repeat the above steps to schedule recording/capture for other days in the week. If the schedule can also be set to other days, click **Copy**.

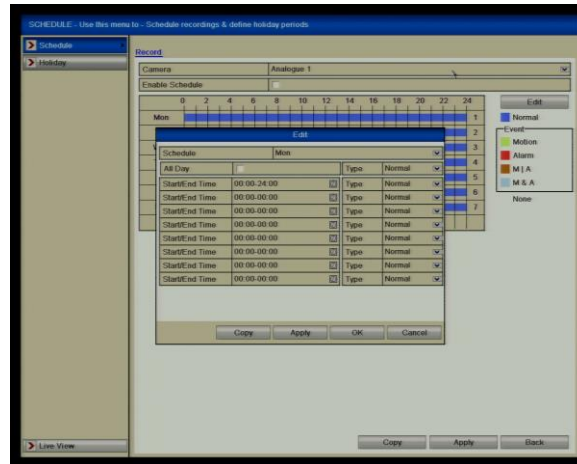

Figure 5.4c Copy Schedule to Other Days

Note: The **Holiday** option is available when you enable holiday schedule in **Holiday** settings. See Chapter 5 - Configuring Holiday Record

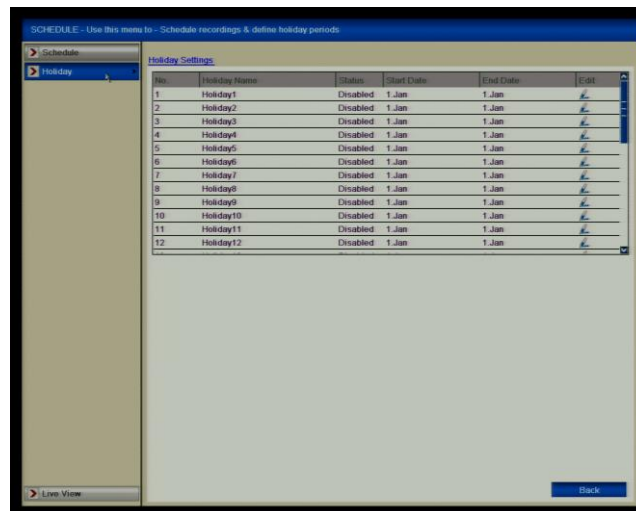

Figure 5.4d Holiday Settings

Return to Schedule.

Click **Apply** in the Record Schedule interface to save the settings.

Click **OK** to save settings and return to previous menu.

Option 2 Using Draw function

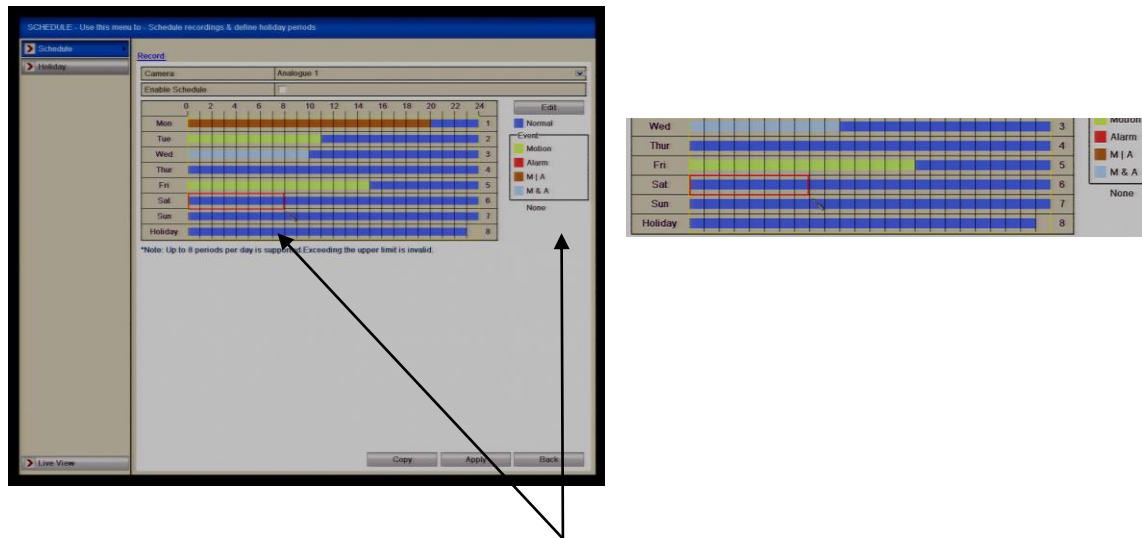

Instead of using the Edit function to set the schedule times for the different recording types, if you move the mouse cursor over the Normal or Event type coloured boxes, the cursor will change to a pen icon and you can then use this to draw a box for the required record type covering the required time interval. When you release the mouse pen icon the red coloured box will change to the event or normal record type colour selected.

You can use the Copy option to copy the schedule settings to other cameras and click Apply in the Record Schedule to save the settings.

5.5 Configuring Motion Detection Record

Purpose:

Follow the steps to set the motion detection parameters. In the live view mode, once a motion detection event takes place, the DVR can analyse it and apply various results. Enabling the motion detection function can trigger certain channels to start recording, trigger full screen monitoring, audio warning, notify the surveillance centre and so on. In this chapter, you can follow the steps to schedule a recording, which is triggered by motion detection.

Steps:

Enter the Motion Detection interface.

Menu>Video>Motion

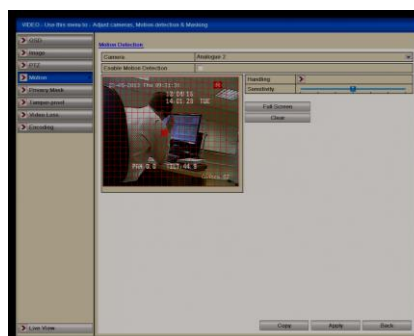

Figure 5.5a Motion Detection

Configure Motion Detection

Choose camera you want to configure.

Check the checkbox after **Enable Motion Detection**.

Drag and draw the area for motion detection by mouse. If you want to set the motion detection for the whole area, click **Full Screen**. To clear the motion detection area, click **Clear**.

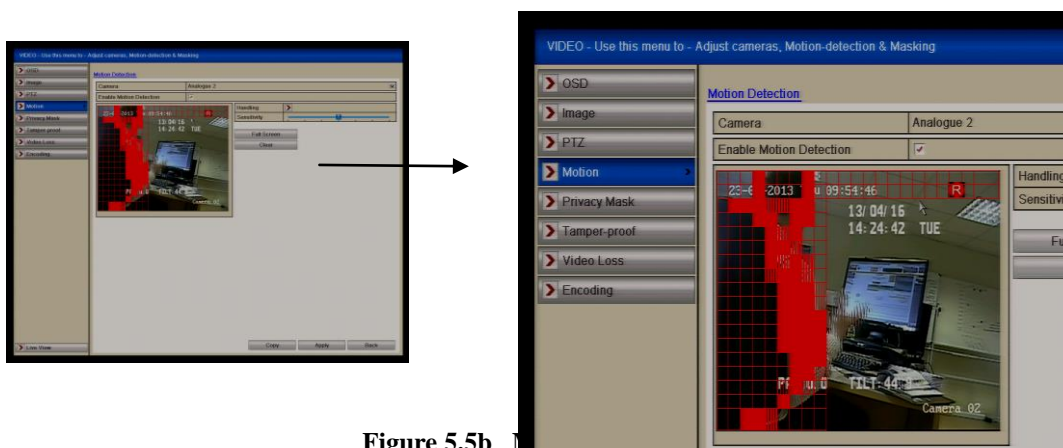

Figure 5.5b

Click **Handling** and the message box for channel information will display.

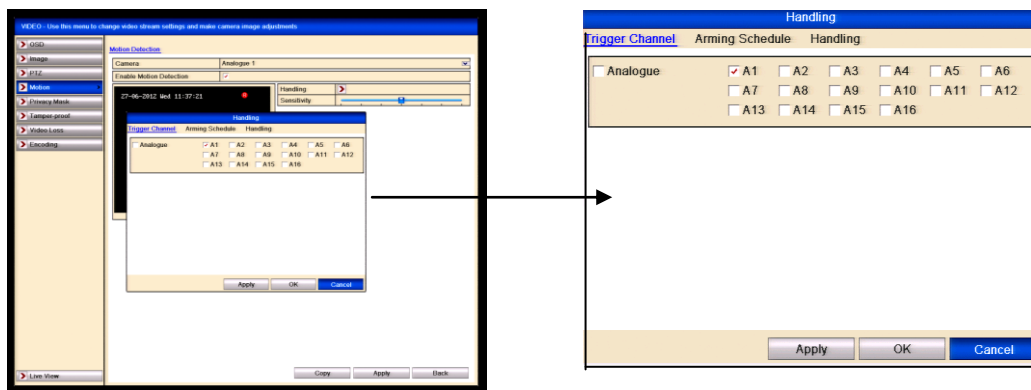

Figure 5.5c Motion Detection Handling

Select the channels which you want the motion detection event to trigger recording.
 Click **Apply** to save the settings.
 Click **OK** to return to the previous menu..
 Exit the Motion Detection menu.

Enter Schedule settings interface.
Menu> Schedule> Schedule>Record

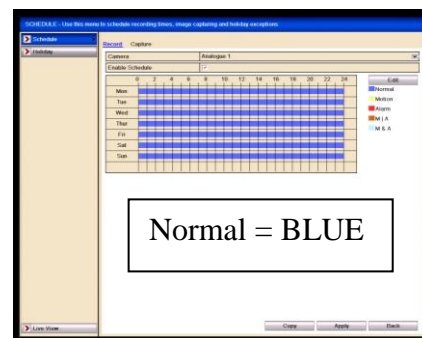

Figure 5.5d Record Schedule

Check the checkbox after the **Enable Schedule** item.
 Click **Edit**.

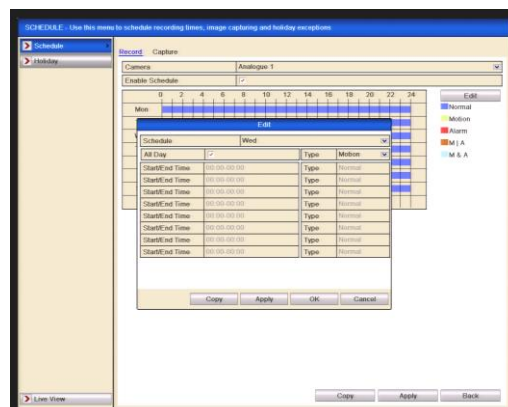

Figure 5.5e Edit Schedule- Motion Detection

In the message box, you can choose the day to which you want to set schedule.
 Set the **Type** as Motion.

To schedule an all-day recording, check the checkbox after the **All Day** item.

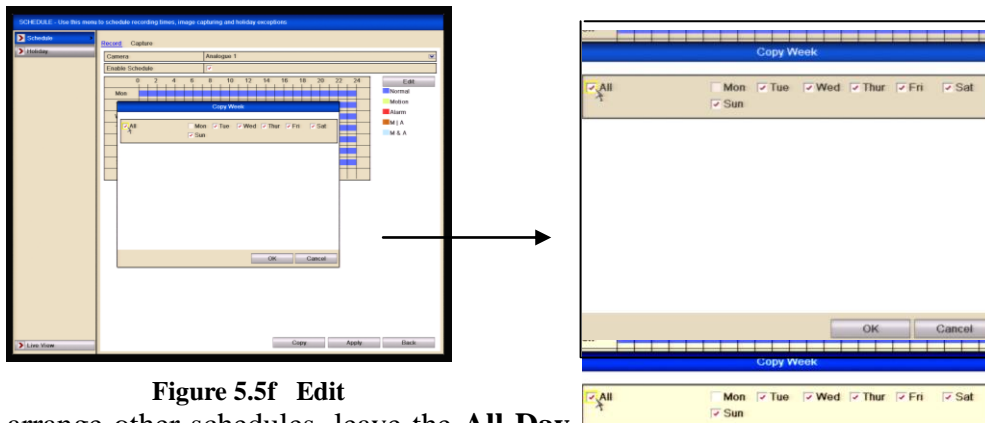

Figure 5.5f Edit

To arrange other schedules, leave the **All Day** time.

Note: Up to 8 periods can be configured for each consecutive and must not overlap each other.

Repeat the above steps for triggering recording/c same time period applies for other days, then jus

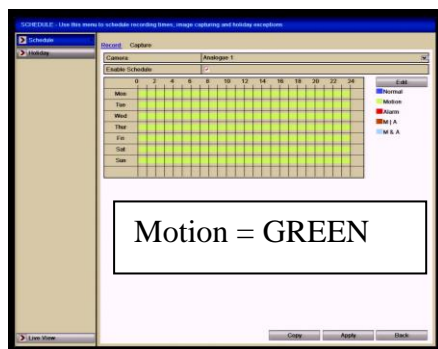

Figure 5.5g Motion Detection for Channel 1 for all days

Click **OK** to return to upper level menu.

You can repeat steps to set schedule for other channels. If the settings can also be used for other channels, click **Copy** and then choose the channel that you want to copy. Then click **OK** and **Back** to return to menu page.

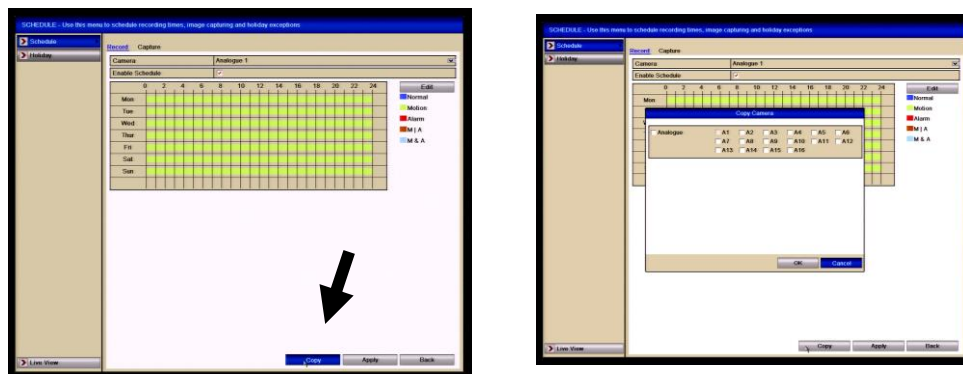

Figure 5.5h Copy Schedule to Other Channels

5.6 Configuring Alarm Triggered Record

Purpose:

Follow the procedure to configure alarm triggered recordings.

Steps:

Enter the Alarm setting interface.

Menu> Setup> Alarm

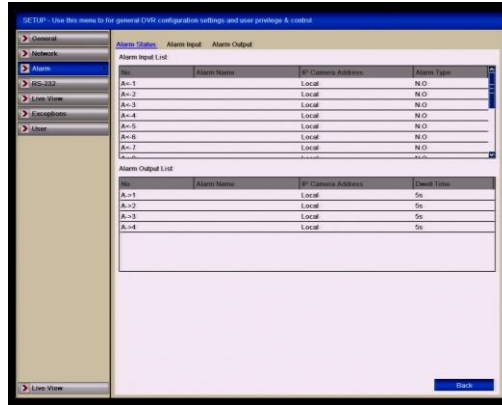

Figure 5.6a Alarm Settings

Click **Alarm Input**.

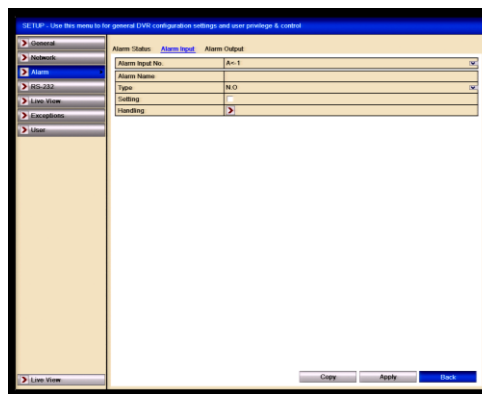

Figure 5.6b Alarm Settings- Alarm Input

Select Alarm Input number and configure alarm parameters.

Choose N.O (normally open) or N.C (normally closed) for alarm type.

Check the checkbox for Setting .

Click **Handling**.

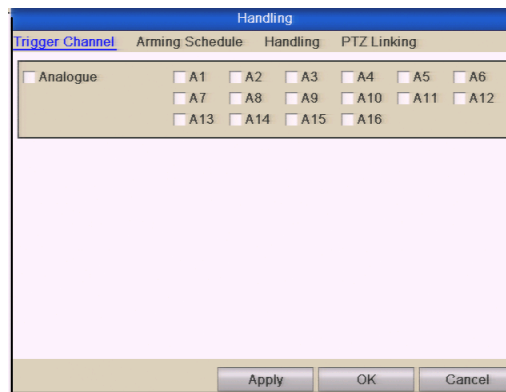

Figure 5.6c Alarm Handling

Choose the alarm triggered recording channel.
 Check the checkbox to select channel.
 Click **Apply** to save settings.
 Click **OK** to return to the previous menu.

Repeat the above steps to configure other alarm input parameters.
 If the setting can also be applied to other alarm inputs, click **Copy** and choose the alarm input number.

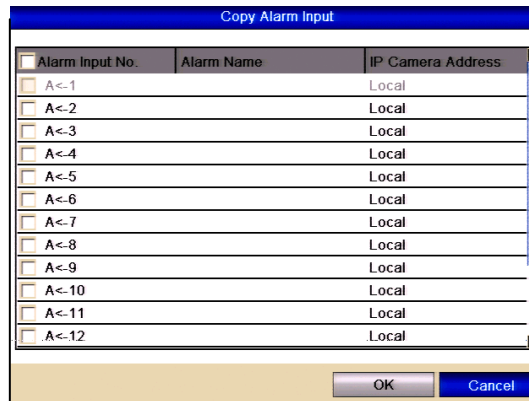

Figure 5.6d Copy Alarm Input

Enter Record Schedule setting interface.
Menu> Schedule> Schedule
 Click Record Schedule
 Check the checkbox after the **Enable Schedule**.

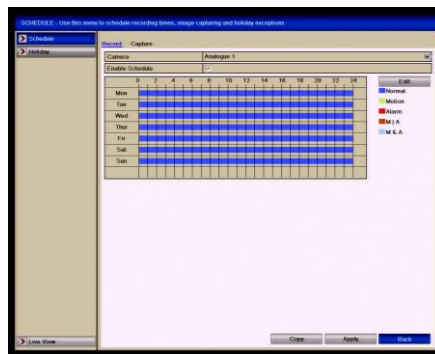

Figure 5.6e Record Schedule

Click **Edit**.
 Set the **Type** to **Alarm**
 In the display box you can choose the day that you want to set schedule.
 To schedule an all-day recording, check the checkbox for **All Day**.
 To setup other schedules, leave the **All Day** checkbox blank and set the period start and end time.

Note: Up to 8 periods can be configured for each day but the time periods must be consecutive and must not overlap each other.

Repeat the above steps to trigger recording/capture for the whole week. If the same time periods apply for other days, click **Copy**. Click **OK** to return to previous menu.

5.7 Instant Record

Purpose:

Follow the steps to set parameters for Instant record and manual alarm triggering. Using Instant record you need to manually cancel the recording. The Instant recording has priority over scheduled recording.

Steps:

Enter the Instant settings interface.

Menu > **Instant**

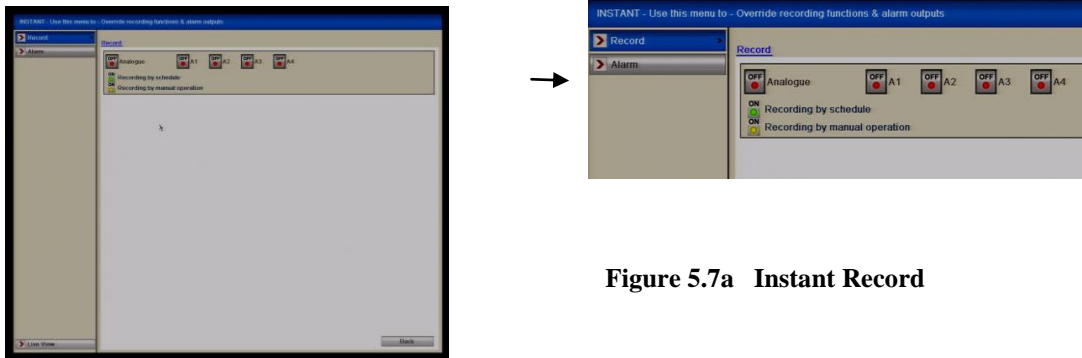

Figure 5.7a Instant Record

Enabling Instant Record

Select **Record** on the left bar.

Click the status button before camera number to change **OFF** to **ON** for each camera or click on Analogue status button to select all cameras.

Disable manual record

Click the status button to change **ON** to **OFF** for each camera or click on Analogue status button to select all cameras.

Note: After rebooting all the manual records enabled are cancelled.

5.8 Configuring Holiday Record

Purpose:

Follow the steps to configure the record or capture schedule on holiday for that year. You may want to have different plan for recording and capture on holiday.

Steps:

Enter the Record setting interface.

Menu>Schedule

Choose **Holiday** on the left bar.

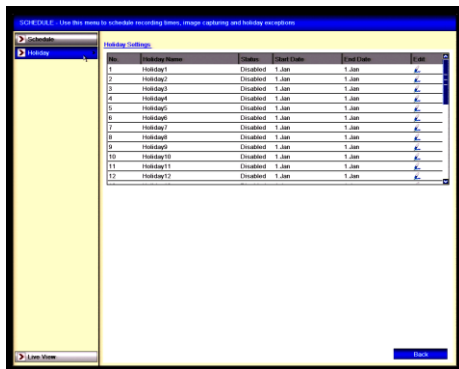



Figure 5.8a Holiday Settings

Enable Edit Holiday schedule

Click  to enter the Edit interface.

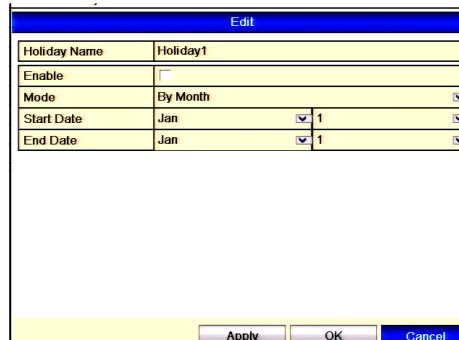

Figure 5.8b Edit Holiday Settings

Check the checkbox after **Enable**.

Select Mode from the dropdown list.

There are three different modes for the date format to configure holiday schedule.

Set the start and end date.

Click **Apply** to save settings.

Click **OK** to exit the Edit interface.

Enter Record settings interface.

Menu> Schedule> Schedule

Select **Record**

Check the checkbox after **Enable Schedule**.

Click **Edit**.

Select **Holiday** from the **Schedule** dropdown list.

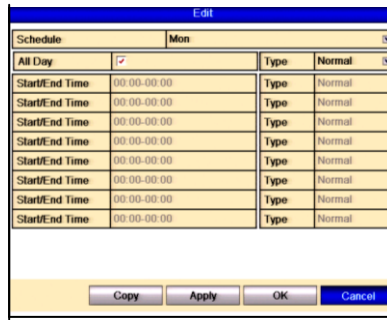

Figure 5.8c Edit Schedule- Holiday

Select **Motion or Normal** from the **Type** dropdown list.

If you need all day recording, check the **All Day** checkbox. Otherwise leave it blank. Set start/end time for holiday schedule.

Note: Up to 8 periods can be configured for each day but the time periods must be consecutive and must not overlap each other.

In the timetable for the channel, both holiday schedule and normal day schedule are displayed.

Repeat the above steps to set Holiday schedule for other channels. If the holiday period schedule can also be used for other channels, click **Copy** and choose the channel you want to apply the same settings.

5.9 Configuring Redundant Recording

Purpose:

Enabling redundant recording, allows recorded files to be not only recorded on a hard drive but also duplicated on another hard drive for backup purposes in the event that a hard drive fails. This is accomplished by setting up a redundant HDD that will effectively enhance the data safety and reliability. **Note that this option is only available for DVRs with more than one hard drive fitted. There should be at least another HDD which is in Read/Write status. Also you must set the Storage mode in the HDD advanced settings to Group before you set the HDD property to Redundant.** For detailed information, please refer to **Chapter 10 Managing HDD**

Group. Steps:

Enter HDD Information interface.

Menu> Drives

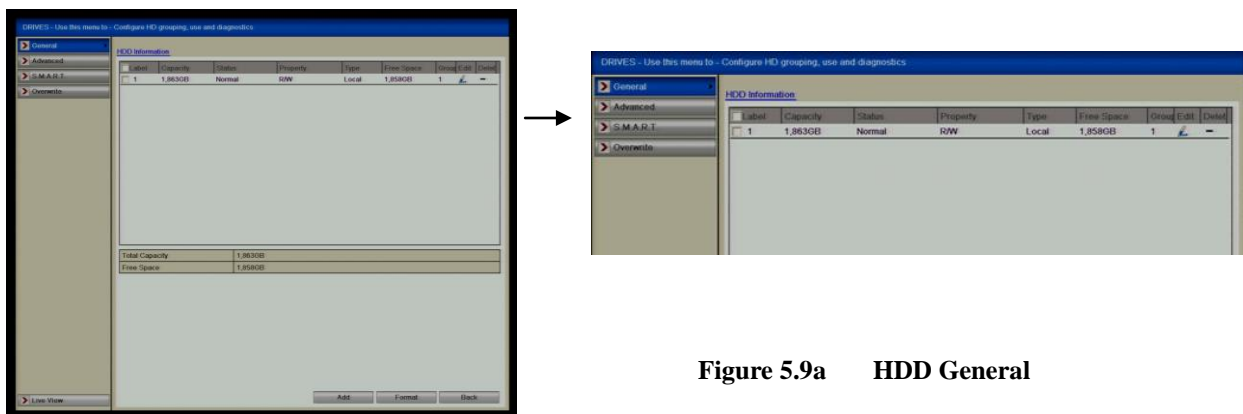



Figure 5.9a HDD General

Select the **HDD** and click  to enter the Local HDD Settings interface. Set the HDD property to Redundant.

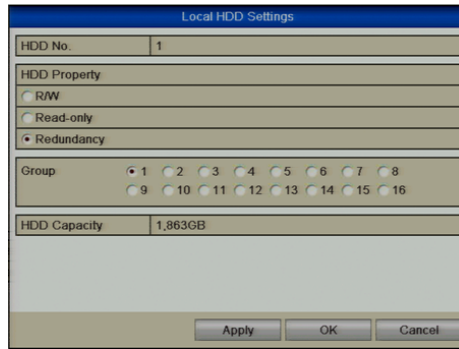

Figure 5.9b HDD General-Editing

Click **Apply** to save the settings. Click **OK** to return to the previous menu.

Enter the Video setting interface. **Menu> Video> Encoding** Select **Record**.

Select camera number a tick the Redundant Record box. Click Apply then Back.

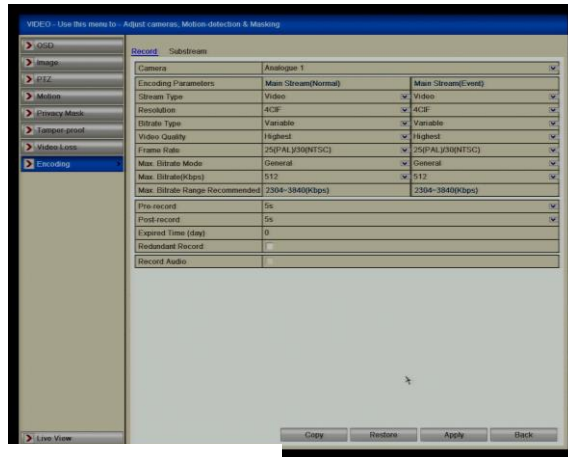

Figure 5.9c Encoding Record

5.10 Configuring HDD Group for Recording

Purpose:

You can group the HDDs and save the recorded files in certain HDD groups.

Steps:

Enter HDD setting interface.

Menu>Drives

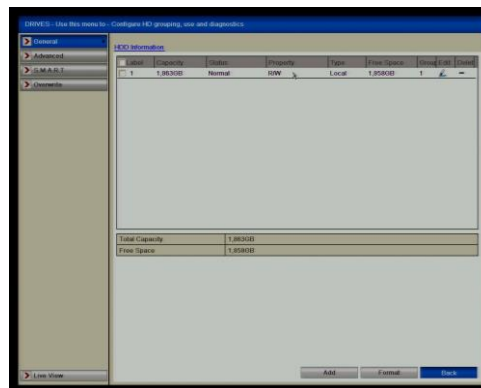
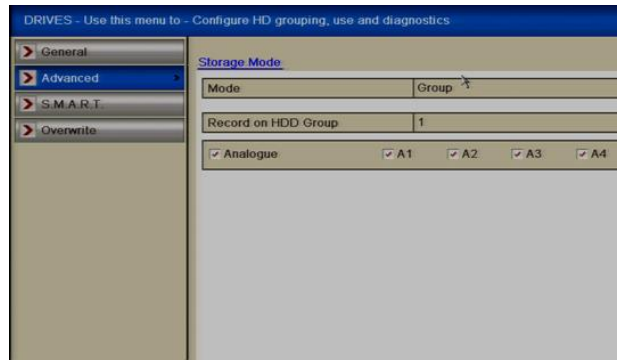



Figure 5.10a HDD General

Select **Advanced**



Check whether the storage mode of the HDD is Group. If not, set it to Group. For detailed information, please refer to **Chapter 10 Managing HDD Group**. Select **General** in the left bar.

Click  to enter editing interface.

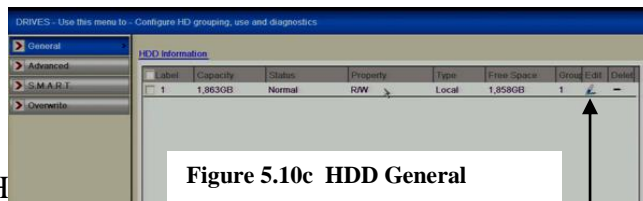

Figure 5.10c HDD General

Configuring HDD group.

Choose a group number for the HDD.

Click **Apply** and then in display box, click **Yes** to save your settings.

Click **OK** to return to previous menu.

Repeat the above steps to configure more HDD groups.

Select the Channels for saving the recorded files and captured pictures in the required HDD group.

5.11 File Protection

Purpose:

You can lock the recorded files or set the HDD property to Read-only to protect recorded files from being overwritten.

Protect files by locking the recorded files:

Steps:

Enter Playback setting interface.

Menu> **Play**

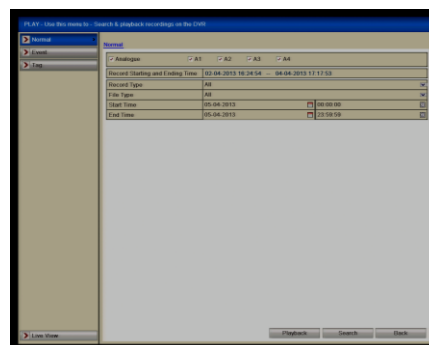

Figure 5.11a Playback

Select the channels you want to investigate by ticking the checkbox .

Select the record type, file type and start/end time. Click Search to show results.

Click **Search** to show the results.

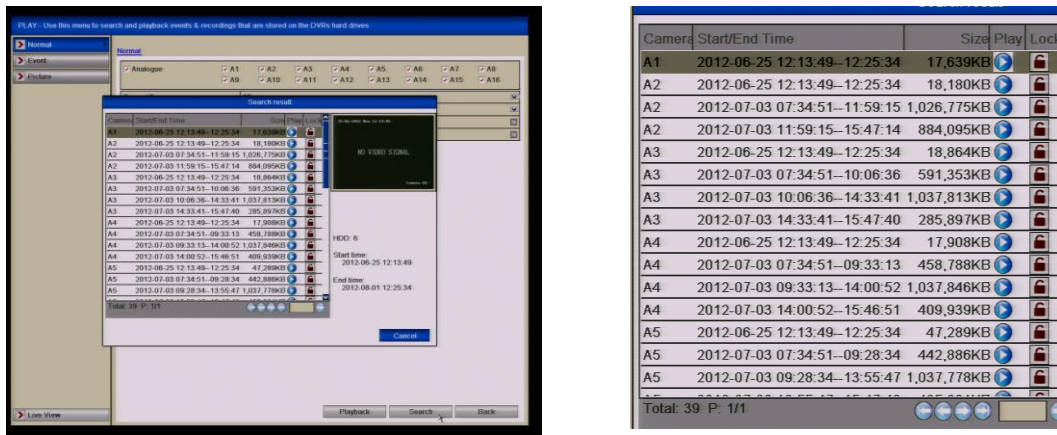

Figure 5.11b Playback- Search Result

Protect the record files

Find the record files you want to protect, and then click the icon, which will turn to , indicating that the file is locked.

Note: Recorded files that are still open and being updated cannot be locked. Click to change it to to unlock the file and the file is not protected.

Warning: Unlocking a file that is outside the file retention period will immediately delete the file. Only unlock if you do not require the file. The following warning will be displayed:

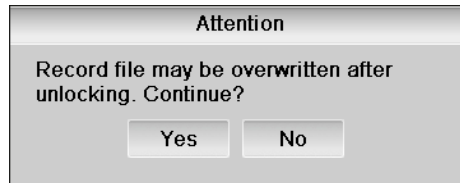

Figure 5.11c Unlocking Attention

Protect file by setting HDD property to Read-only

Note: To edit HDD property, you need to set the storage mode of the HDD to Group. See **Chapter 10 Managing HDD Group**.

Steps:

Enter HDD setting interface.

Menu> Drives

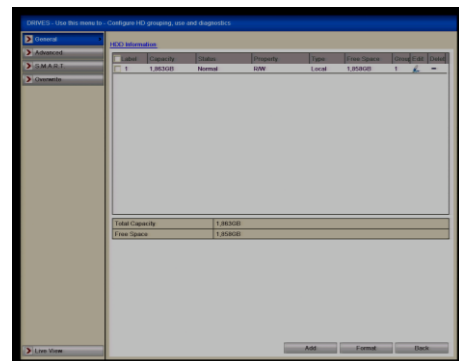

Figure 5.11d HDD General

Click to edit the HDD you want to protect.

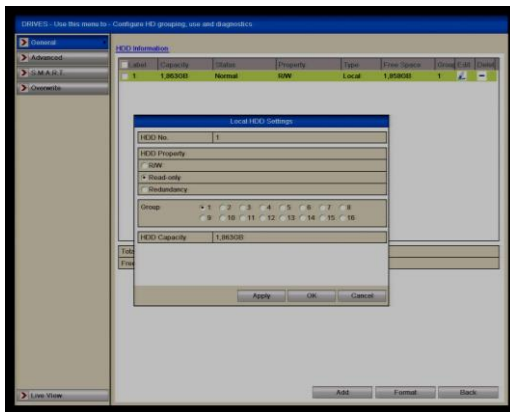

Figure 5.11e HDD General - Editing

Set the HDD to Read-only.

Click **OK** to save settings and return to previous menu.

Note: You cannot save any files on a Read-only HDD. If you want to save files on the HDD, change the property to R/W (Read/Write). If there is only one HDD and it is set to Read-only, the device will not record any files. Only live viewing mode is available. If you set the HDD to Read-only when the device is saving files to it, the file will be saved in the next R/W HDD. If there is only one HDD, the recording will stop.

6. Playback

6.1 Playing Back by Channel

Purpose:

Play back the recorded video files of a specific channel in the live view mode.

Channel switch is supported.

Instant playback by channel:

Steps:

Choose a channel in live view mode using the mouse and click the  button in the quick setting toolbar.

Note: Only record files recorded during the last five minutes on this channel will be played back.



Figure 6.1a Instant Playback Interface

All-day Playback by channel

Enter the All-day Playback interface.

Mouse: right click a channel in live view mode and select All-day Playback from the menu, as shown.

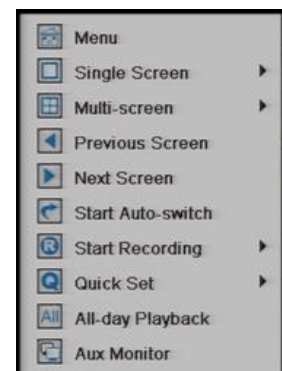

Figure 6.1b Right-click Menu under Live View

Front Panel: Press **PLAY** button to play back recorded files of the channel in single-screen live view mode. Under multi-screen live view mode, the recorded files of the top-left channel will be played back.

Note: Pressing numerical buttons will switch playback to the corresponding channels during playback process.

Playback management

The toolbar at the bottom of the Playback interface can be used to control playing progress, as shown below.

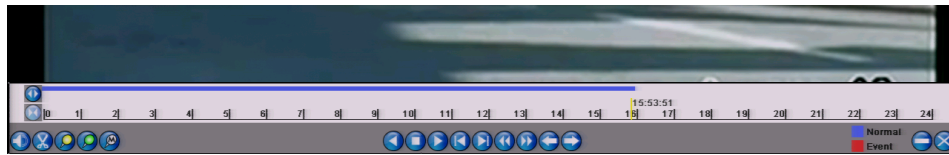

Figure 6.1c All-day Playback Interface

The channel and time selection menu displays by moving the mouse to the right of the playback interface. Click the channel(s) if you want to switch playback to another channel or execute simultaneous playback of multiple channels, as shown below.

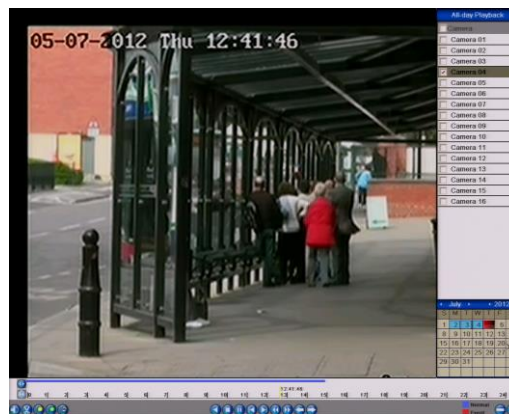

Figure 6.1d All-day Playback Interface with Channel List

Record Options marked in colours:

- Red: There are Event Recorded file/s for this day
- Blue: There are Continuous Recorded file/s for this day

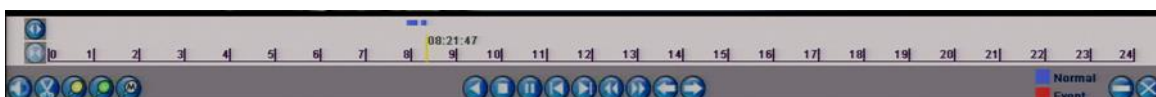

Table 6.1e Detailed Explanation of All-day-playback Toolbar

Button	Operation	Button	Operation	Button	Operation	Button	Operation
	Audio on /Mute		Start/Stop clipping		30s forward		30s reverse
	Add default tag		Add customised tag		Tag management		Speed down
	Pause reverse play/Reverse play/Single-frame reverse play		Pause play/Play/Single-frame play		Stop		Speed up
	Previous day		Next day		Hide		Exit
	Process bar		Video type bar		Zoom In		Zoom Out

Note:

Playback progress bar: Use the mouse to click any point of the progress bar or drag the progress bar to locate special frames.

About video type bar: ■ represents normal recording (manual or schedule); ■ represents event recording (motion, alarm, motion | alarm, motion & alarm).

6.2 Playing Back by Time

Purpose:

Play back video files recorded in specified time duration. Multi-channel, simultaneous playback and channel sequencing are supported.

Steps:

Enter playback interface.

Menu>Play

Set search conditions and click the Playback button to enter Playback interface.

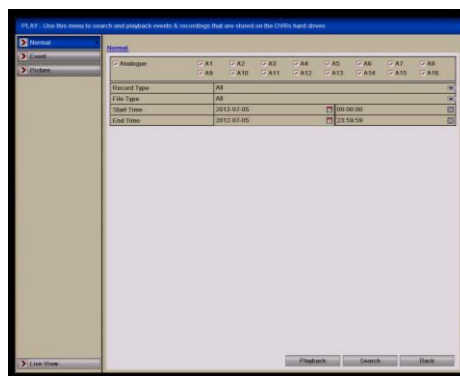

Figure 6.2a Video Search by Time

In the Playback interface:

The toolbar at the bottom of the Playback interface can be used to control playing process, as shown below.



Figure 6.2b Interface for Playback by Time



Table 6.2d Detailed Explanation of Playback by time Toolbar

Button	Operation	Button	Operation	Button	Operation	Button	Operation
	Audio on /Mute		Start/Stop clipping		30s forward		30s reverse
	Add default tag		Add customised tag		Tag management		Speed down
	Pause reverse play/ Reverse play/ Single-frame reverse play		Pause play/ Play/ Single-frame play		Stop		Speed up
	Video Search		Video type bar		Hide		Exit
	Progress bar						

Note:

Playback progress bar: Use the mouse to click any point on the progress bar or drag the progress bar to locate special frames.

About video type bar: ■ represents normal recording (manual or schedule); ■ represents event recording (motion, alarm, motion | alarm, motion & alarm).

6.3 Playing Back by Normal Video Search

Purpose:

Play back video files searched by restricting recording type and recording time. The video files in the result list are played back sequentially and channel switch is supported. Recording types contain Normal, Motion, Alarm, Motion / Alarm, Motion & Alarm, Manual and All.

Steps:



Enter Record File Search interface.

Menu>Play

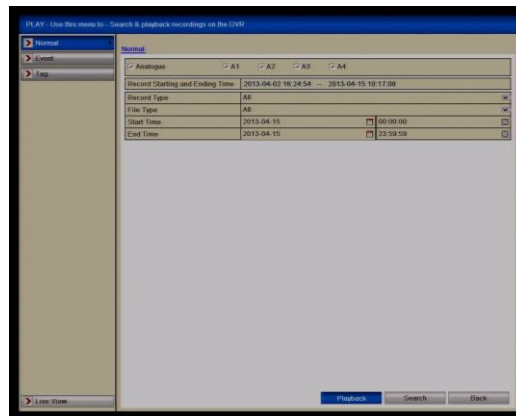
Set search condition and click Search button to enter the Search Result interface.



6.3a Normal Video Search

Choose a record file you want to play back. If there is only one channel in the search result, clicking  button takes you to Full-screen Playback interface of this channel. If more than one channel is optional, clicking  button takes you to further steps.

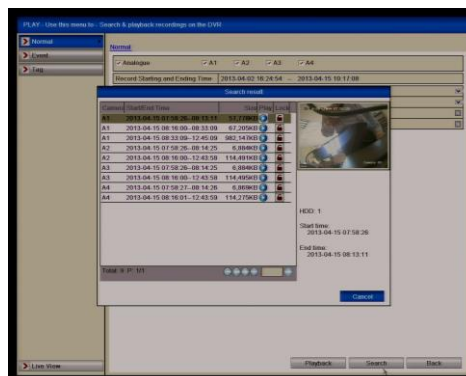

Figure 6.3b Result of Normal Video Search

Choose channels for simultaneous playback.

Note: Optional channels for simultaneous playback are the same as the channels chosen to search record files. The channel with the recorded file selected is the main channel during multi-channel playback and it is displayed at the upper left corner.

The 4-ch, 8-ch and 16-ch devices support 4-ch, 8-ch and 16-channel simultaneous playback

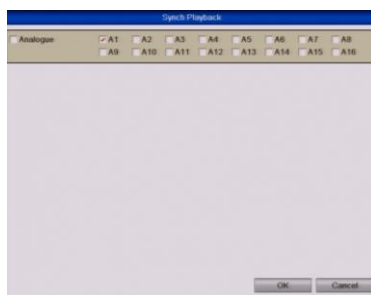

Figure 6.3c Select Channels for Synchronous Playback

Synchronous Playback interface

The toolbar in the bottom part of Playback interface can be used to control playing process.



Figure 6.3d 4-ch Synchronous Playback Interface

The hidden list of recorded files displays by moving the mouse to the right of the playback interface.

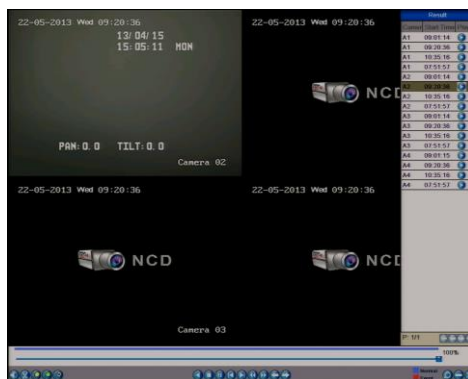

Figure 6.3e 4-ch Synchronous Playback Interface with Video List



Figure 6.3f Toolbar for Normal Playback

Table 6.3g Detailed Explanation of Normal Playback Toolbar

Button	Operation	Button	Operation	Button	Operation	Button	Operation
	Audio on /Mute		Start/Stop clipping		30s forward		30s reverse
	Add default tag		Add customised tag		Tag management		Speed down
	Pause reverse play/ Reverse play/ Single-frame reverse play		Pause play/ Play/ Single-frame play		Stop		Speed up
	Video Search		Video type bar		Hide		Exit
	Progress bar						

Playback progress bar: use the mouse to click any point of the progress bar or drag the progress bar to locate special frames.

About video type bar: ■ represents normal recording (manual or schedule); ■ represents event recording (motion, alarm, motion | alarm, motion & alarm).

6.4 Playing Back by Event Search

Purpose:

Play back recorded files on one or several channels by restricting event type (e.g. alarm input and motion detection). Channel switch is supported.

Steps:

Enter the playback interface.

Menu>Play

Select **Event** tab to enter the Event Playback interface.

Select **Motion** as the event type.

NOTE: PLAYBACK BY ALARM IS NOT SUPPORTED ON THIS DVR.

Click **Search** button to enter the Search Result interface.

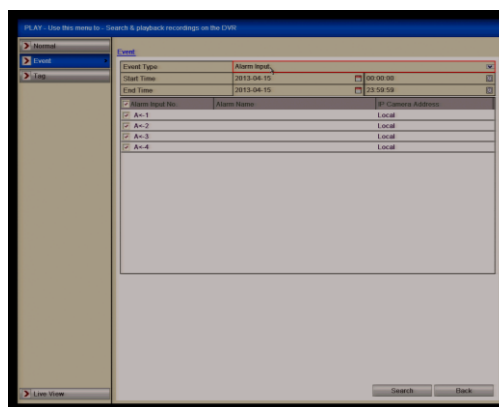

Figure 6.4a Video Search by Event

If you want to play back recorded files associated with motion detection, choose **Motion** as event type and click **Search** button to enter the Search Result interface.

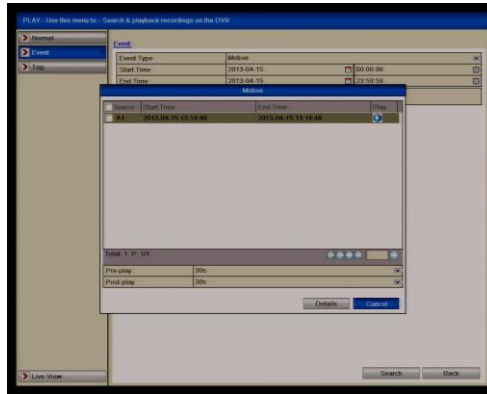

Figure 6.4b Video Search by Motion

Click  button to enter the Playback interface. **Note:** Pre-play and post-play can be configured.

Click **Details** button to view detailed information about the recorded file, e.g. start time, end time, file size, etc.

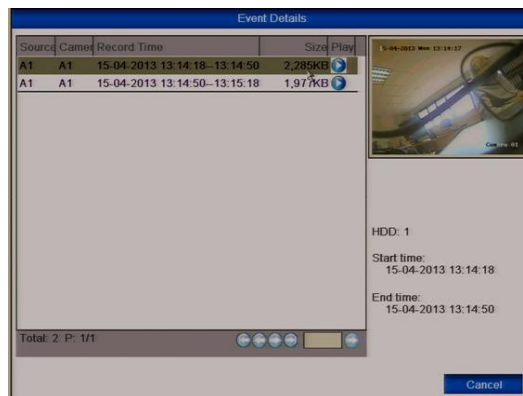

Figure 6.4c Motion Details Interface

Playback interface

The toolbar in the bottom part of Playback interface can be used to control playing process.



Figure 6.4d Interface for Playback by Event (a)

The hidden list of events will be displayed by moving the mouse to the right of the playback interface.



Figure 6.4e Interface for Playback by Event (b)

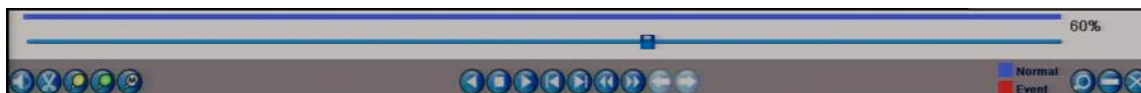

Figure 6.4f Toolbar for Playback by Event

Table 6.4g Detailed Explanation of Playback-by-event Toolbar

Button	Operation	Button	Operation	Button	Operation	Button	Operation
	Audio on /Mute		Start/Stop clipping		30s forward		30s reverse
	Add default tag		Add customised tag		Tag management		Speed down
	Pause reverse play/ Reverse play/ Single-frame reverse play		Pause play/ Play/ Single-frame play		Stop		Speed up
	Video Search		Video type bar		Hide		Exit
	Progress bar		Previous Event		Next Event		

Note:

Playback progress bar: Use the mouse to click any point on the progress bar or drag the progress bar to locate special time frames.

About video type bar: Blue represents normal recording (manual or schedule); Red represents event recording (motion, alarm, motion|alarm, motion & alarm).

6.5 Playing Back by Tag

Purpose:

Video tag allows you to record related information like people and location of a certain time point during playback. You are also allowed to use video tag(s) to search for record files and position time point. Playback start/end time can be edited.

Before playing back by tag: Enter Playback interface by selecting **Menu > Play > Normal**, select channel and time and start playback.



Figure 6.5a Interface for Playback by Time

Click  button to add default tag.

Click  button to add customised tag and input tag name.

Note: Max. 64 tags can be added to a single video file.

Tag management

Click  button to check, edit and delete tag(s).

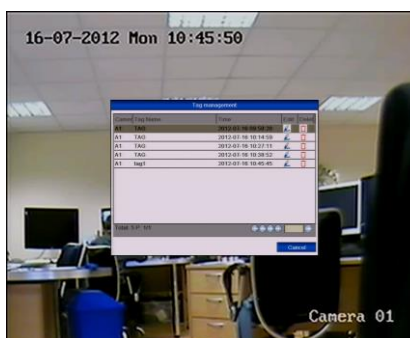

Figure 6.5b Tag Management Interface

Steps:

Enter Playback interface.

Menu>Play

Click Tag tab to enter Playback by Tag interface. Choose channels, tag type and time, and click Search to enter Search Result interface.

Note: Two tag types are selectable: **All** and **Tag Keyword**. Input keyword if you choose **Tag Keyword**.

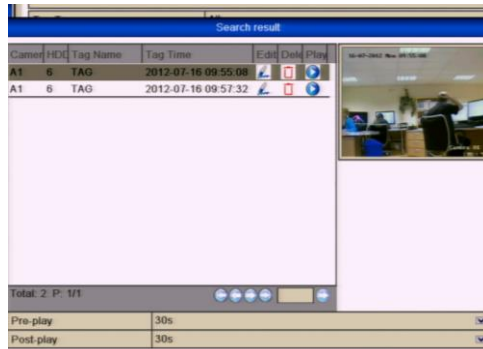

Figure 6.5c Video Search by Tag

Set playback conditions and tag management.

Choose the tag name of the recorded file you want to play back; it can be edited or deleted.

Pre-play and post-play time can be set according to actual needs.

Note: Pre-play time and post-play time is added to the time point of the tag.

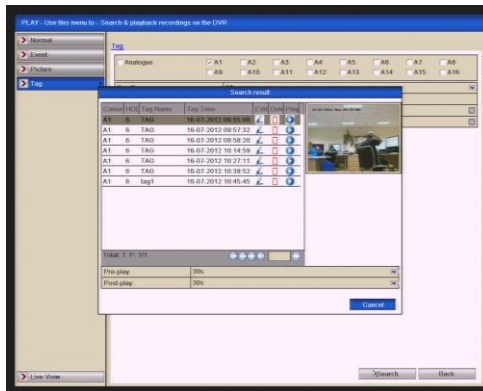

Figure 6.5d Result of Video Search by Tag

Playback by tag

Choose a tag and click  button to play back the related record file.



Figure 6.5e Interface for Playback by Tag

The hidden list of tags will be displayed by moving the mouse to the right of the playback interface.



Figure 6.5f Interface of Playback by Tag with Video List

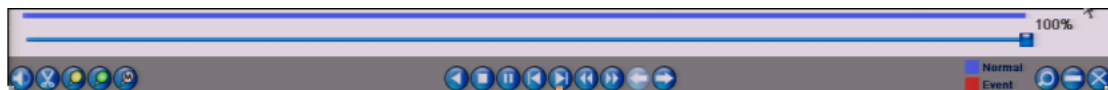

Figure 6.5g Toolbar for Playback by Tag

Table 6.5h Detailed Explanation of Playback-by-tag Toolbar

Button	Operation	Button	Operation	Button	Operation	Button	Operation
	Audio on /Mute		Start/Stop clipping		30s forward		30s reverse
	Add default tag		Add customised tag		Tag management		Lower Speed
	Pause reverse play/ Reverse play/ Single-frame reverse play		Pause play/ Play/ Single-frame play		Stop		Increase Speed
	Previous Tag		Next Tag		Tag Search		Exit
	Progress bar		Video Type Bar		Hide		

Note:

Playback progress bar: Use the mouse to click any point of the progress bar or drag the progress bar to locate special time frames.

About video type bar: Blue represents normal recording (manual or schedule); Red represents event recording (motion, alarm, motion|alarm, motion & alarm).

6.6 Playing Back by System Log

Purpose:

Play back record file(s) associated with channels after searching system logs.

Steps:

Enter Log Search interface.

Menu>Tools>Log Search

Set search time and type and click **Search** button.

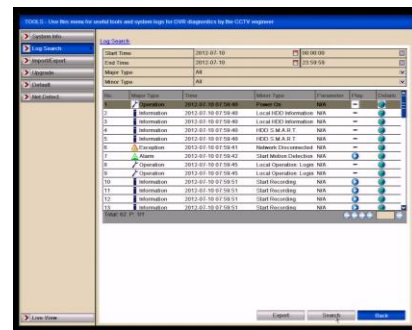

Figure 6.6a System Log Search Interface

Choose a log with record file and click  button to enter Playback interface.

Note: If there is no record file for this time point in the log, the message “No result found” will display.

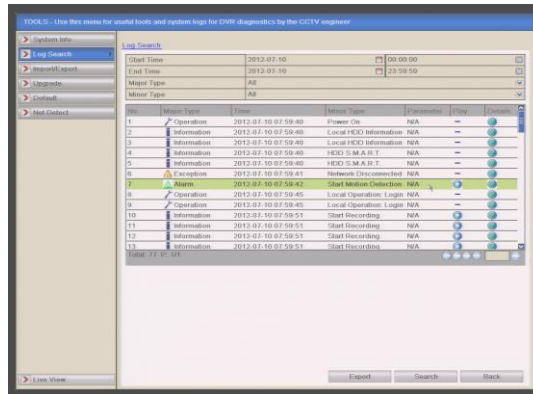

Figure 6.6b Result of System Log Search

Playback interface

The toolbar in the bottom part of the Playback interface can be used to control playing process.

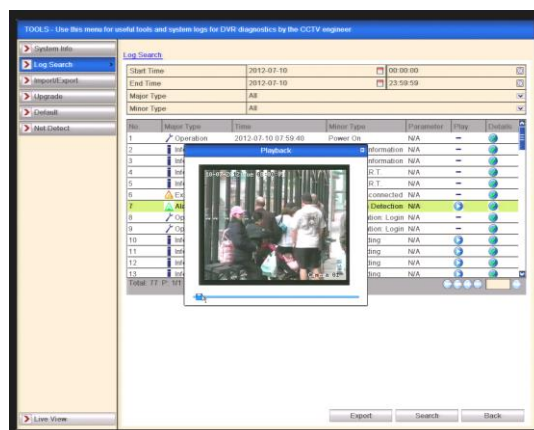

Figure 6.6c Interface for Playback by Log

6.7 Playing Back Frame by Frame

Purpose:



To allow playback of video files, frame by frame, in order to check image details when abnormal events occur.

Steps:



Using a Mouse:

Go to the Playback interface.

Selecting playback of the recorded file

Click button  and  until the speed changes to **Single** frame and one click on the playback screen represents playback of one frame.

Selecting reverse playback of the recorded file

Click button  and  until the speed changes to **Single** frame and one click on the playback screen represents reverse playback of one frame. It is also feasible to use the pause button  in toolbar.

6.8 Instant Detective

Purpose:

In order to locate motion detection events easily and accurately in the playback progress bar, you can analyse a certain area (scene) dynamically and find all of the related motion detection events that occurred in this area.

Steps:

Go to Playback interface and play the video.

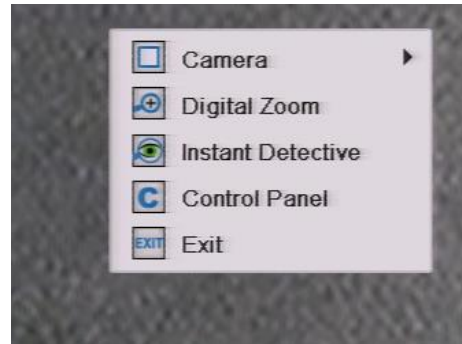



Figure 6.8a Interface for Playback by Time

Right-click mouse and select Instant Detective to go to analysis area selection interface.



Figure 6.8b Right-click Menu under Playback

You can click button marked Full Screen to set the full screen as target search area.

After drawing area(s), click button  to execute Instant Detective search in this area.

Note: Multi-area and full-screen searching modes are supported.

See pictures below.

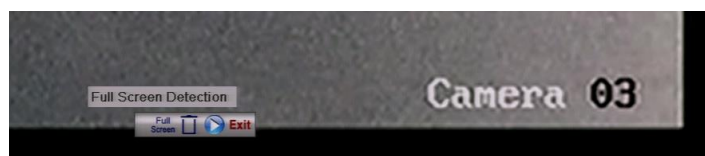





Figure 6.8c Instant Detective controls

Results of intelligent analysis

Video type bar

- : Normal record file
- : Event record file
- : Dynamic record file.

The hidden list of recorded files display when moving the mouse to the right of the playback interface.



Figure 6.8d Instant Detective Search Result with Video List

Figure 6.8e Toolbar for Instant Detective Playback



Table 6.8f Detailed Explanation of Instant Detective Toolbar

Button	Operation	Button	Operation	Button	Operation	Button	Operation
	Audio on /Mute		Start/Stop clipping		30s forward		30s reverse
	Add default tag		Add customised tag		Tag management		Lower Speed
	Pause reverse play/ Reverse play/ Single-frame reverse play		Pause play/ Play/ Single-frame play		Stop		Speed up
	Previous Instant Detective search result		Next Instant Detective search result		Video Search		Exit
	Hide		Progress Bar		Video Type		Instant Detective Search Bar

Note:

Playback progress bar: Use the mouse to click any point on the progress bar or drag the progress bar to locate special time frames.

About video type bar: Blue represents normal recording (manual or schedule); Red represents event recording (motion, alarm, motion | alarm, motion & alarm).

6.9 Digital Zoom

Steps:

Right click the mouse on a channel under playback and choose Digital Zoom to enter Digital Zoom interface.

Use the mouse to draw a red rectangle and the image within it will be enlarged up to 16 times.

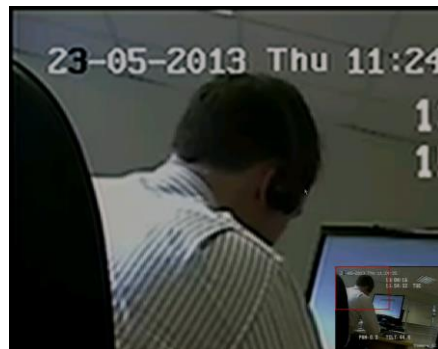

Figure 6.9a Draw Area for Digital Zoom

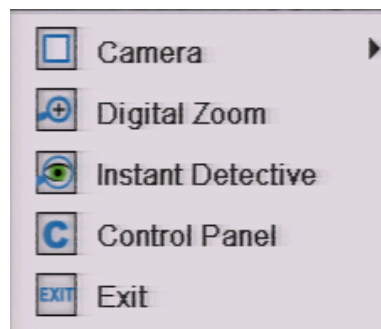







Figure 6.9b Right-click Menu in Playback

The right-click menu:

Note: This menu differs slightly between one playback interface and another.

Table 6.9c Detailed Explanation of Right-click Menu in Playback

Button	Function
	Return to Search interface
	Enter Digital Zoom interface
	Instant Detective search on a specified area
	Show & hide control interface
	Return to Live View interface

7. Backup

Before you start:

Please insert the backup device(s) into the DVR.

7.1 Quick Export

Purpose:

Export record files to backup device(s) quickly by time.

Steps:

Enter Back Up interface. Choose the channel(s) you want to back up, followed by time period and then click **Quick Export** button.

Note:

The time duration of recorded files on a specified channel cannot exceed one day. Otherwise, the message “Max. 24 hours are allowed for quick export.” will display. The number of channels for synchronous export cannot exceed 4. Otherwise, the message “Max. 4 channels are allowed for synchronous quick export.” will display.

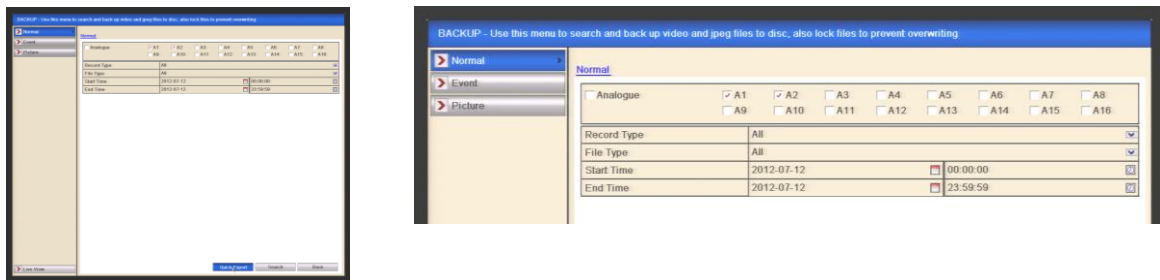

Figure 7.1a Quick Export Interface

Export

Go to Export interface, choose backup device and create folder name, double click it and then click **Export** button to start exporting.

Note: Here you can only use a USB Flash Drive so please refer to the next section using Normal Backup for other backup devices supported by the DVR.

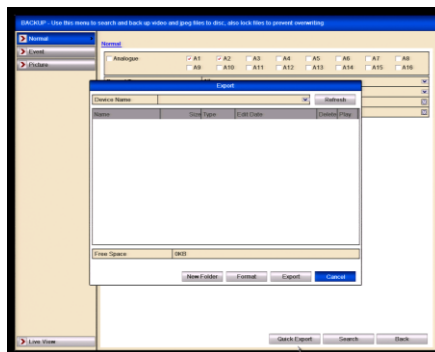

Figure 7.1b Quick Export using USB

Stay in the Exporting interface until all record files are exported.

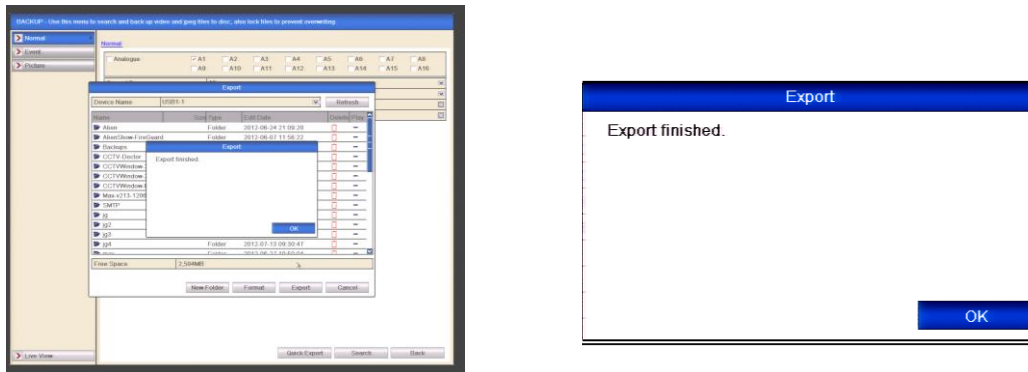



Figure 7.1c Export Finished

Check backup result.

Select folder to display recorded file/s and player program.

Choose the recorded file in Export interface and click button  to check it.

Note: The Player player.exe is exported automatically during record file export.

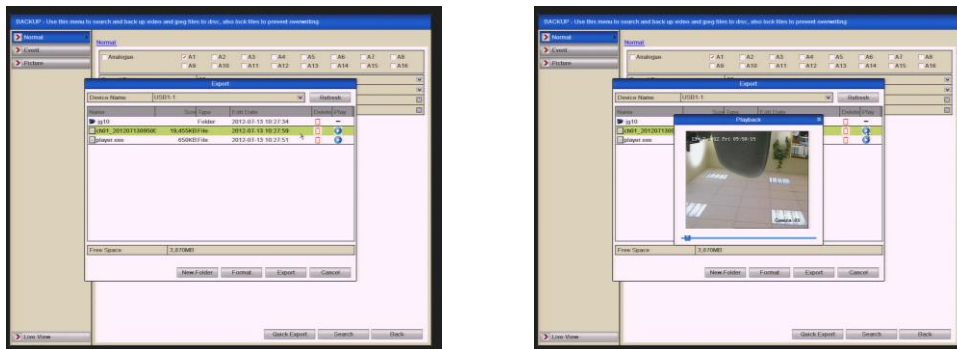

Figure 7.1d Checkup of Quick Export Result Using USB

To exit Playback click on the small X located in the far right corner of the Playback panel.

7.2 Backing up by Normal Video Search

Purpose:

The recorded files can be backed up to various devices, such as USB devices (USB flash drives, USB HDDs, USB writer) and SATA writer dependent on model.

Backup Steps:

Enter Export interface.

Menu>Back Up>Normal

Set search condition and click **Search** button to enter the search result interface.

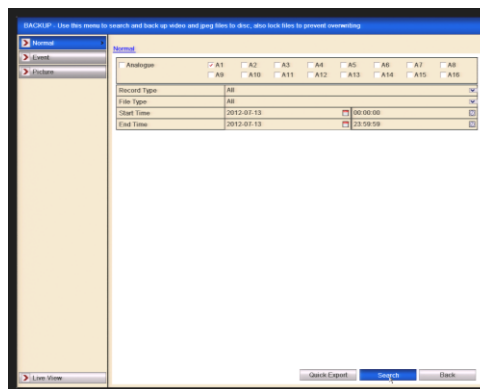



Figure 7.2a Normal Video Search for Backup

Select record files you want to backup.

Click button  to play the recorded file if you want to check it.
Click the checkbox before starting the backup.

Note: The size of the currently selected files is displayed in the lower-left corner of the window.

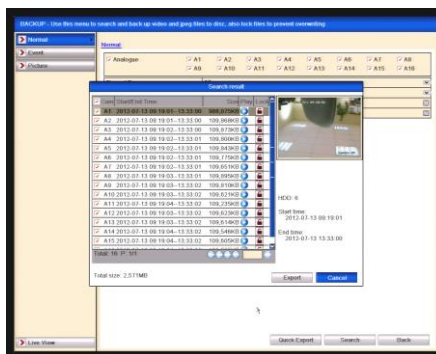

Figure 7.2b Result of Normal Video Search for Backup

Export

Click **Export** button and start backup.

Note: If the inserted device is not recognised:

Click the **Refresh** button.

Reconnect device.

Check for compatibility from vendor.

You can also format USB flash drives or USB HDDs via the DVR.

Cam	Start/End Time	Size	Play	Lock
<input checked="" type="checkbox"/> A1	2012-07-13 09:19:01--13:33:00	988,075KB		
<input checked="" type="checkbox"/> A2	2012-07-13 09:19:01--13:33:00	109,868KB		
<input checked="" type="checkbox"/> A3	2012-07-13 09:19:02--13:33:00	109,873KB		
<input checked="" type="checkbox"/> A4	2012-07-13 09:19:02--13:33:01	109,800KB		
<input checked="" type="checkbox"/> A5	2012-07-13 09:19:02--13:33:01	109,843KB		
<input checked="" type="checkbox"/> A6	2012-07-13 09:19:02--13:33:01	109,775KB		
<input checked="" type="checkbox"/> A7	2012-07-13 09:19:02--13:33:01	109,651KB		
<input checked="" type="checkbox"/> A8	2012-07-13 09:19:03--13:33:01	109,895KB		
<input checked="" type="checkbox"/> A9	2012-07-13 09:19:03--13:33:02	109,810KB		
<input checked="" type="checkbox"/> A10	2012-07-13 09:19:03--13:33:02	109,621KB		
<input checked="" type="checkbox"/> A11	2012-07-13 09:19:04--13:33:02	109,235KB		
<input checked="" type="checkbox"/> A12	2012-07-13 09:19:03--13:33:02	109,623KB		
<input checked="" type="checkbox"/> A13	2012-07-13 09:19:03--13:33:02	109,614KB		
<input checked="" type="checkbox"/> A14	2012-07-13 09:19:04--13:33:02	109,546KB		
<input checked="" type="checkbox"/> A15	2012-07-13 09:19:04--13:33:02	109,605KB		

Total: 16 P: 1/1

Figure 7.2c Export by Normal Video Search using USB Flash Drive

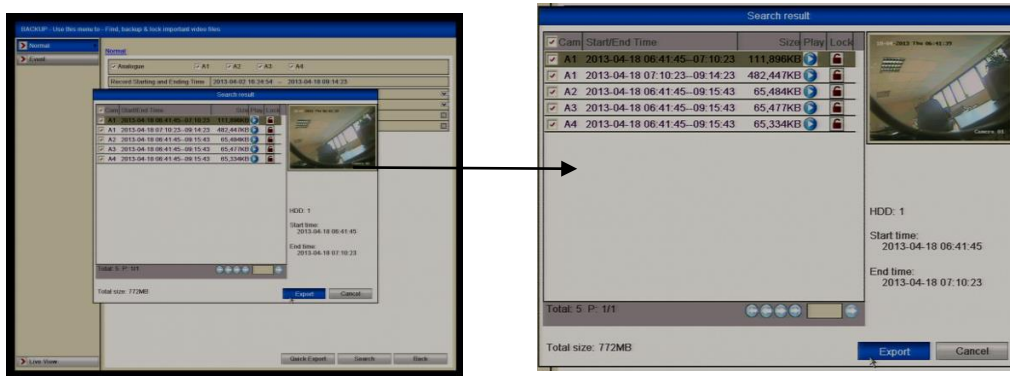

Figure 7.2d Export by Normal Video Search using USB Writer

Stay in the Exporting interface until all recorded files are exported and displaying “Export finished”.

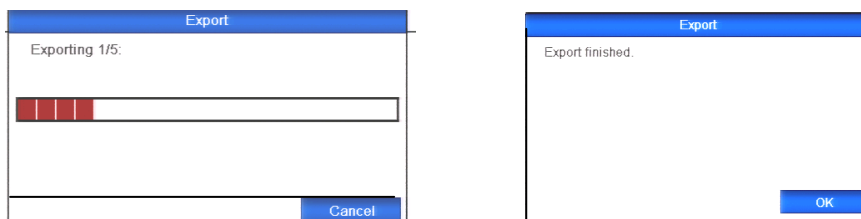



Figure 7.2e Export Finished

Check backup result

Choose the recorded file in Export interface and click button  to check it.
Note: The Player player.exe will be exported automatically during file export.

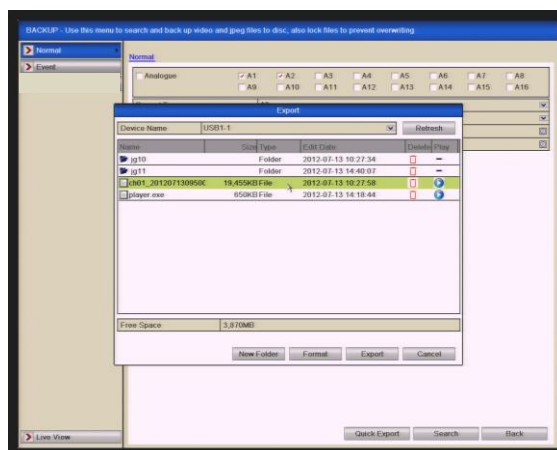

Figure 7.2f Checkup of Export Result using USB Flash Drive

You can exit playback by clicking on X in top right hand corner of Playback screen.

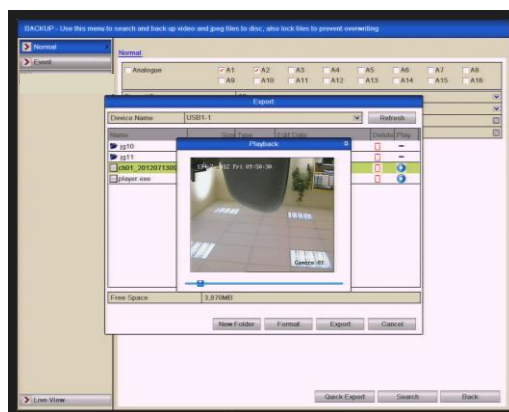

Figure 7.2g Checkup of Export Result using USB Writer

7.3 Backing up by Event Search (Motion) only

Purpose:

Back up event-related record files using USB devices (USB flash drives, USB HDDs, USB writer) and SATA writer dependent on model. Quick Backup and Normal Backup are supported.

Steps:

Enter Export interface.

Menu>Backup>Event

Select "Motion" from the dropdown list of Event Type.

NOTE: Alarm Input Search is not supported.

Select the alarm input No. and time.

Click **Search** button to enter the Search Result interface.

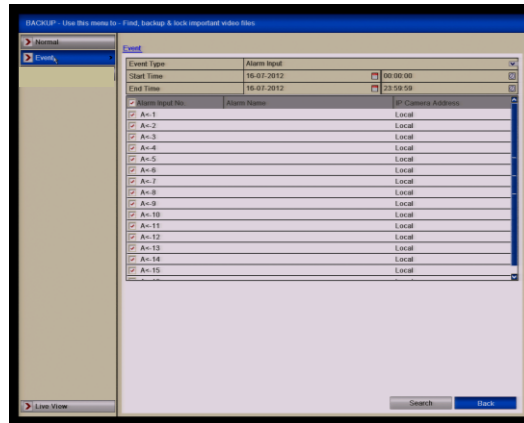

Figure 7.3a Event Search for Backup

Select record files to export.

Select an alarm input in the list and click **Quick Export** button to enter Export interface. Clicking **Details** button will take you to the interface with detailed information of all channels triggered by the Motion input.

Clicking **Quick Export** button will export record files of all channels triggered by the Motion input.

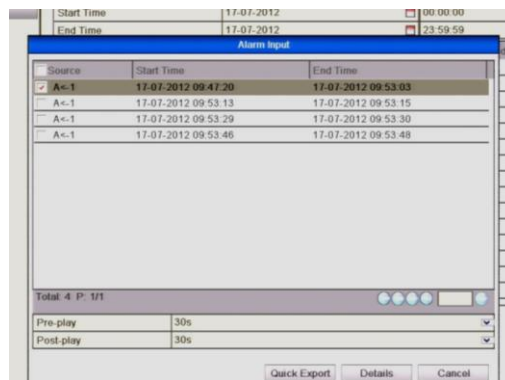

Figure 7.3b Result of Event Search

Click Details button to view detailed information of the record file, e.g. start time, end time, file size, etc.

Note: The size of the currently selected files is displayed in the lower-left corner of the window.



Figure 7.3c Event Details Interface

Export.

Click the **Export** button and start backup.

Note: If the inserted USB device is not recognised:

Click the Refresh button.

Reconnect device.

Check for compatibility from vendor.

You can also format USB flash drive or USB HDDs via the DVR.

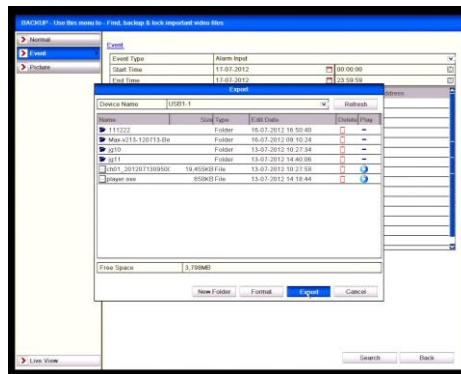

Figure 7.3d Export by Event Using USB Flash Drive

Stay in the Exporting interface until all record files are exported with message “Export finished” displayed.

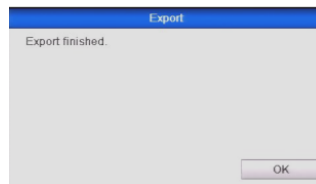

Figure 7.3e Export Finished

Check backup result.

Note: The Player player.exe will be exported automatically during record file export.

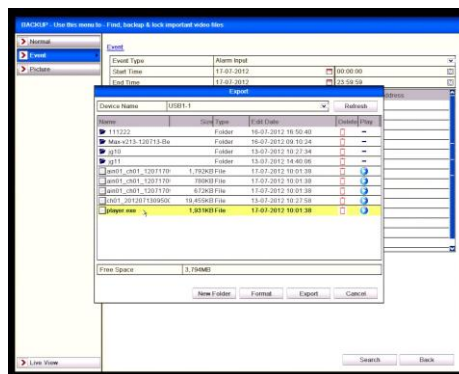

Figure 7.3f Checkup of Event Export Result using USB Flash Drive

7.4 Backing up Video Clips



Purpose:

You may also select video clips to export directly during Playback, using USB devices (USB flash drives, USB HDDs, USB writer) or SATA writer dependent on model.

Steps:

Enter Playback interface.

Please refer to **Chapter 6**.

During playback, use buttons  and  in the playback toolbar to start or stop clipping record file(s).

Quit Playback interface after finishing clipping and you will then be prompted to save the clips.

Note: A maximum of 30 clips can be selected for each channel.



Figure 7.4a Interface for Playback by Time

Click **Yes** to save video clips and enter Export interface, or click **No** to quit and do not save video clips.

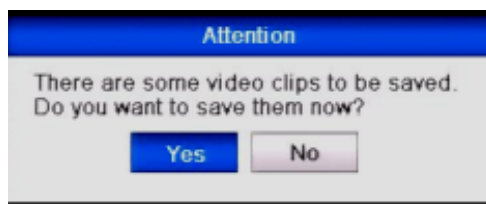

Figure 7.4b Video Clip Saving

Export.

Click **Export** button and start backup.

Note: If the inserted USB device is not recognized:

Click the **Refresh** button.

Reconnect device.

Check for compatibility from vendor.

You can also format USB flash drive or USB HDDs via the device.

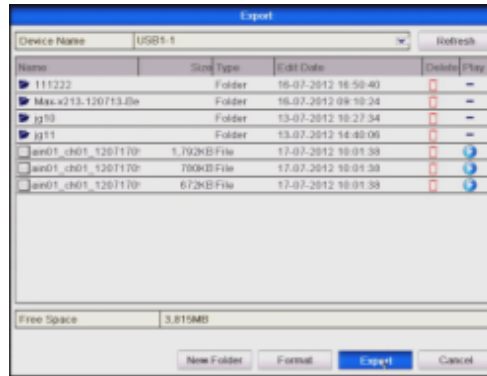

Figure 7.4c Export Video Clips using USB Flash Drive

Stay in the Exporting interface until all recorded files are exported with message “**Export finished**” displayed.

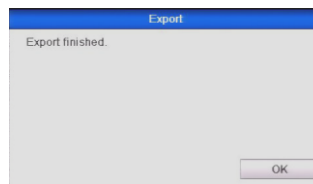

Figure 7.4d Export Finished

Check backup result.

Note: The program Player.exe will be exported automatically during record file export.

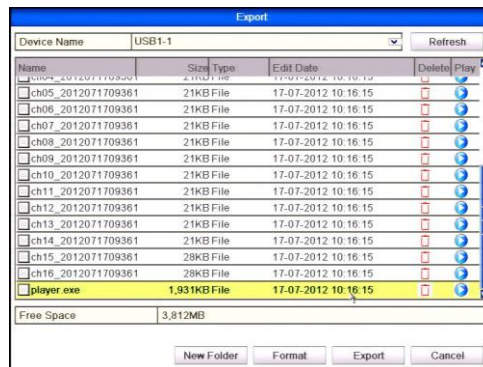

Figure 7.4e Checkup of Video Clip Export Results using USB Flash Drive

7.6 Managing Backup Devices

Management of USB flash drives and USB HDDs

Enter Search Result interface of record files.

Menu>Backup>Normal

Set search condition and click **Search** button to enter Search Result interface.

Note: At least one channel shall be selected.

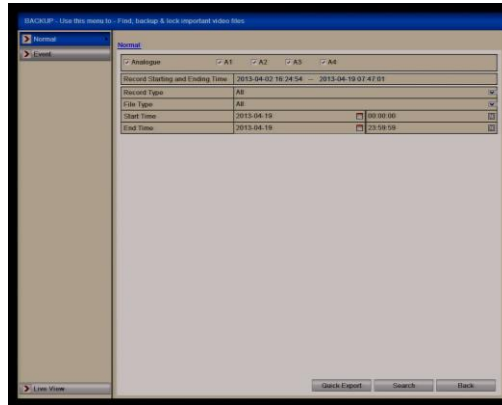

Figure 7.6a Normal Video Search for Backup

Select record files you want to back up.

Click **Export** button to enter Export interface.

Note: At least one record file shall be selected.

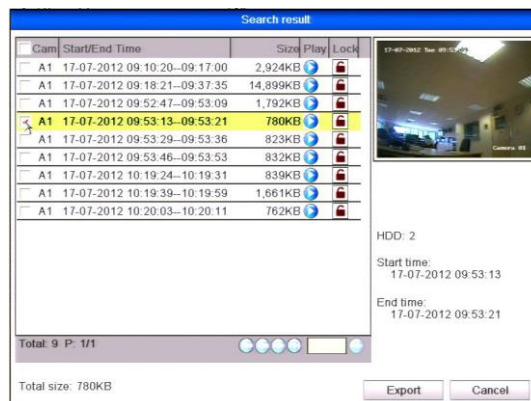



Figure 7.6b Result of Normal Video Search for Backup

Backup device management.

Click **New Folder** button if you want to create a new folder on the backup device.

Select a recorded file or folder on the backup device and click button  if you want to delete it.

Select a recorded file in the backup device and click button  to play it.

Click **Format** button to format the backup device.

Note: If the inserted USB device is not recognised:

Click the **Refresh** button.
 Reconnect device.
 Check for compatibility from vendor.

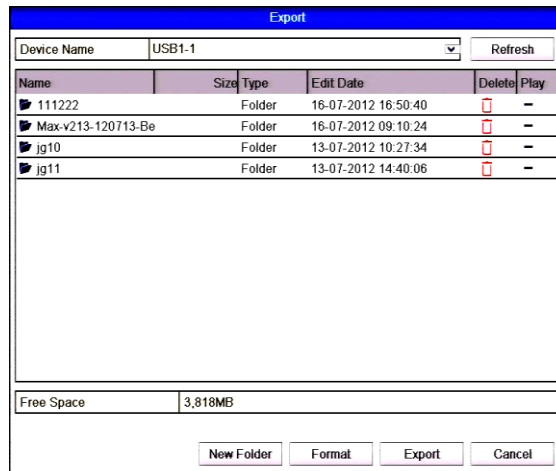

Figure 7.6c USB Flash Drive Management

Management of USB writers and DVD-R/W dependent on model

Enter Search Result interface of record files.

Menu>Backup>Normal

Set search condition and click **Search** button to enter Search Result interface.

Note: At least one channel shall be selected.

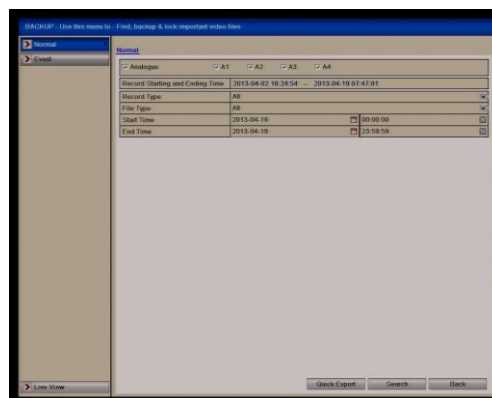

Figure 7.6d Normal Video Search for Backup

Select record files you want to back up.

Click **Export** button to enter Export interface.

Note: At least one record file shall be selected.

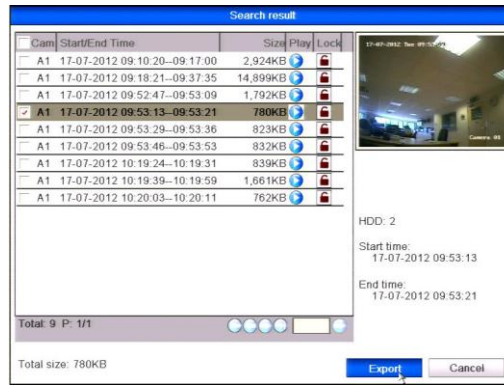

Figure 7.6e Result of Normal Video Search for Backup

Backup Device Management

Click **Erase** button if you want to erase the files from a re-writable CD/DVD.

Note: There must be a re-writable CD/DVD when you undertake this operation.

If the inserted USB writer or SATA writer is not recognised:

Click the **Refresh** button.

Reconnect device.

Check for compatibility from vendor.

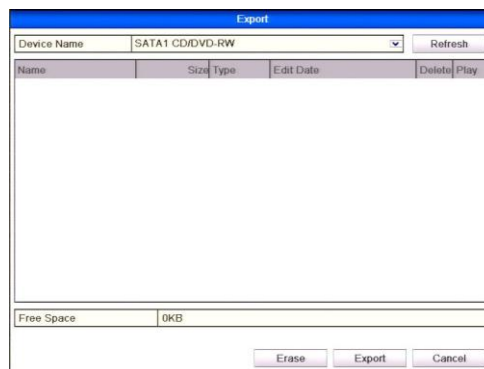

Figure 7.6f USB Writer Management

8. Event Settings

Purpose: This section covers motion detection, alarm settings, video loss, video tampering, fault exceptions, alarm response and manually triggering or clearing alarms.

8.1 Motion Detection

Steps:

Enter Motion Detection interface of Camera Management and choose a camera you want to set up motion detection.

Menu> Video> Motion

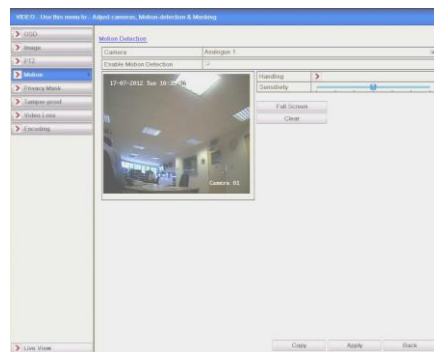

Figure 8.1a Motion Detection Setup Interface

Set up detection area and sensitivity

Tick “Enable Motion Detection”, use the mouse to draw detection area(s) and drag the sensitivity bar to set sensitivity.

Click **Handling** button and set alarm response actions.

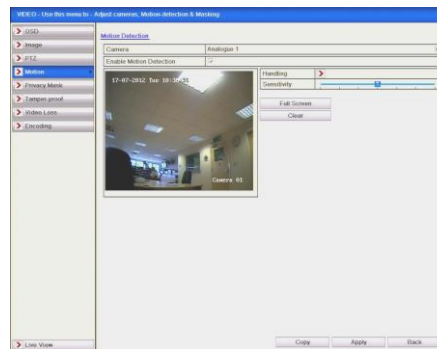

Figure 8.1b Set Detection Area and Sensitivity

Click **Trigger Channel** tab and select one or more channels which will start to record/capture and can display full-screen monitoring when motion alarm is triggered.

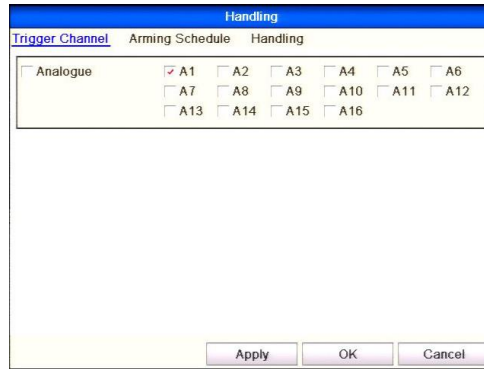

Figure 8.1c Trigger Camera for Motion Detection

Set up arming schedule for the channel

Select **Arming Schedule** tab to set the channel’s arming schedule.

Choose one day of a week and up to eight time periods can be set within each day.

Note: Time periods shall not be repeated or overlapped.



Figure 8.1d Set Arming Schedule for Motion Detection

Click **Handling** tab to set up alarm response actions of motion alarm (please refer to **Chapter 8.6**).

Repeat the above steps to set up arming schedule of other days of a week. You can also use **Copy** button to copy an arming schedule to other days.

Click the **OK** button to complete the motion detection settings of the channel. If you want to set up motion detection for another channel, repeat the above steps or just copy the above settings to it. **Note:** You are not allowed to copy the “Trigger Channel” action.

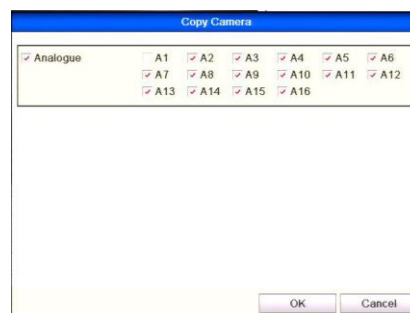

Figure 8.1e Copy Settings of Motion Detection

8.2 Setting up Alarms

Purpose:

Set up handling method for an external sensor alarm.

Steps:

Enter Alarm Settings of System Configuration and select an alarm input.

Menu> Setup> Alarm

Select **Alarm Input** tab to enter Alarm Input Settings interface.

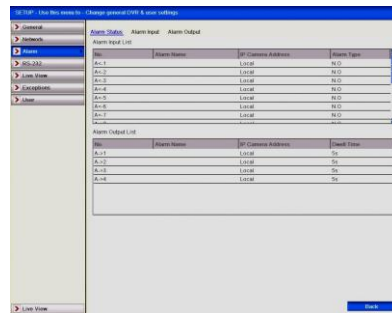

Figure 8.2a Alarm Status Interface of System Configuration

Set up the handling method of the selected alarm input.

Check the **Setting** checkbox and click **Handling** button to set up its alarm response actions.

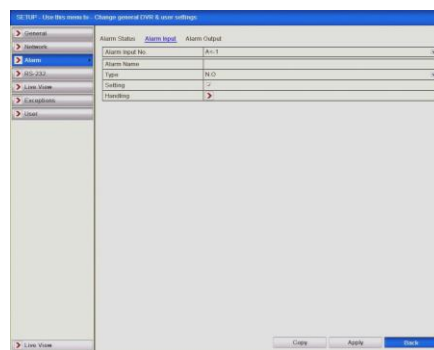

Figure 8.2b Alarm Input Setup Interface

Select Trigger Channel tab and select one or more channels which will start to record/capture or become full-screen monitoring when an external alarm is input.

Select **Arming Schedule** tab to set the channel's arming schedule.

Choose one day of a week and up to eight time periods can be set within each day.

Note: Time periods must be consecutive and must not overlap.

Select **Handling** tab to set up alarm response actions of the alarm input (please refer to **Chapter 8.6**).

Repeat the above steps to set up arming schedule for other days of the week. You can also use **Copy** button to copy an arming schedule to other days.



Figure 8.2c Set Arming Schedule for Alarm Input

If required, select **PTZ Linking** tab and set PTZ linkage for the alarm input. Set PTZ linking parameters and click **OK** to complete the settings of the alarm input. **Note:** Please check whether the PTZ or speed dome supports PTZ linkage. One alarm input can trigger presets, patrols or patterns for more than one channel. However presets, patrols and patterns are exclusive.

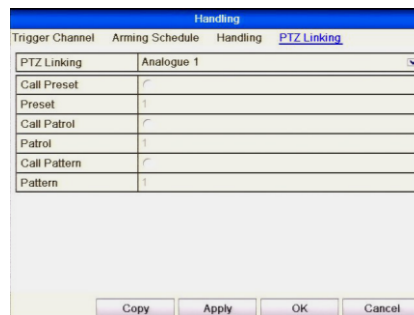

Figure 8.2d Set PTZ Linking of Alarm Input

If you want to set handling method of another alarm input, repeat the above steps or just copy the above settings to it.

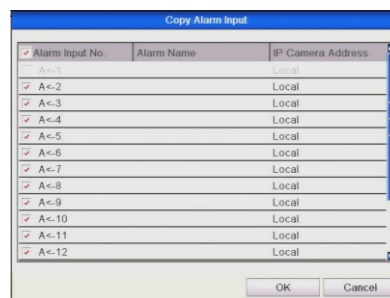

Figure 8.2e Copy Settings of Alarm Input

8.3 Detecting Video Loss

Purpose:

Detect video loss of a channel and take alarm response action(s).

Steps:

Enter Video Loss interface of Camera Management and select a channel you want to detect.

Menu> Video> Video Loss

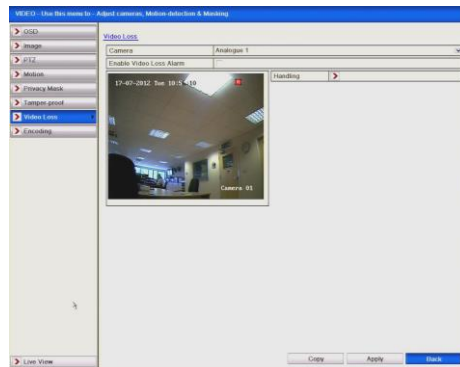

Figure 8.3a Video Loss Setup Interface

Set up handling method of video loss.

Check the checkbox of “Enable Video Loss Alarm”, and click **Handling** button to set up handling method of video loss.

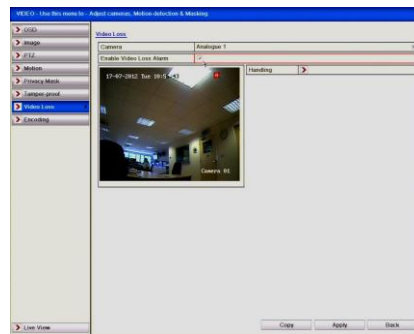

Figure 8.3b Set Handling Method of Video Loss

1. Set up arming schedule of the channel.

Select **Arming Schedule** tab to set the channel’s arming schedule.

Select the day of a week and up to eight time periods can be set within each day.

Note: Time periods must be consecutive and must not overlap.

Handling	
Arming Schedule	Handling
Week	Mon ▼
1	00:00-24:00 [X]
2	00:00-00:00 [X]
3	00:00-00:00 [X]
4	00:00-00:00 [X]
5	00:00-00:00 [X]
6	00:00-00:00 [X]
7	00:00-00:00 [X]
8	00:00-00:00 [X]

Copy Apply OK Cancel

Figure 8.3c Set Arming Schedule for Video Loss

Select **Handling** tab to set up alarm response action of video loss (please refer to **Chapter 8.6**).

Repeat the above steps to set up arming schedule for other days of the week. You can also use **Copy** button to copy an arming schedule to other days.

Click the **OK** button to complete the video loss settings for the channel.

If you want to set up the video loss handling method for another channel, repeat the above steps or just copy the above settings to it.

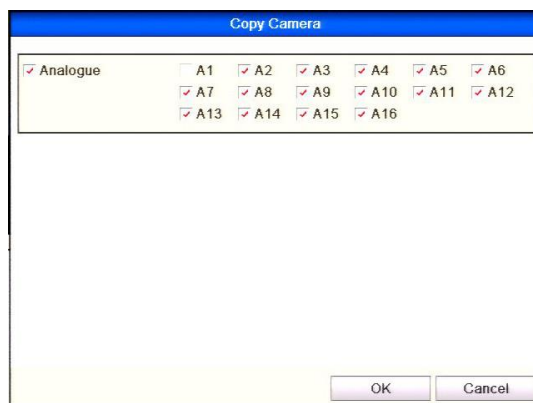

Figure 8.3d Copy Settings for Video Loss

8.4 Detecting Video Tampering

Purpose:

Trigger alarm when the lens is covered and take alarm response action(s).

Steps:

Enter Tamper-proof in Video Menu and select a channel you want to detect video tampering.

Menu> Video> Tamper-proof

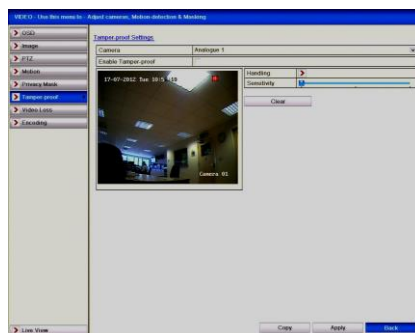

Figure 8.4a Tamper-proof Setup Interface

Set up the video tampering handling method for the channel

Check the checkbox to “Enable Video Tampering”.

Drag the sensitivity bar and choose a sensitivity level. Use the mouse to draw an area you want to detect video tampering.

Click **Handling** button to set up handling method of video tampering.

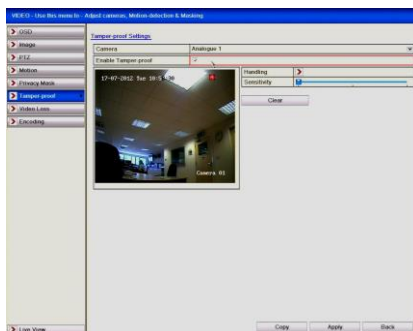

Figure 8.4b Set Detection Area and Sensitivity for Video Tampering

Set up arming schedule and alarm response actions for the channel

Click **Arming Schedule** tab to set the channel’s arming schedule.

Choose a day of the week and up to eight time periods can be set within each day.

Note: Time periods must be consecutive and must not overlap.



Figure 8.4c Set Arming Schedule for Video Tampering

Select **Handling** tab to set up alarm response actions for video tampering alarm (please refer to **Chapter 8.6**).

Repeat the above steps to set up arming schedule for other days of the week. You can also use **Copy** button to copy an arming schedule to other days.

Click the **OK** button to complete the video tampering settings of the channel.

If you want to set up video loss handling method for another channel, repeat same steps or just copy the same settings to it.

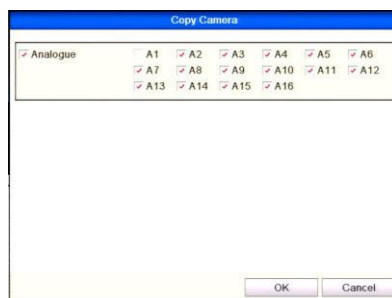

Figure 8.4d Copy Settings for Video Tampering

8.5 Error Exception Reporting

Purpose:

Exception settings refer to the handling method of various exceptions, e.g.

- **HDD Full:** The HDD is full.
- **HDD Error:** Writing HDD error, unformatted HDD, etc.
- **Network Disconnected:** Disconnected network cable.
- **IP Conflicted:** Duplicated IP address.
- **Illegal Login:** Incorrect user ID or password.
- **Input / Output Video Standard Mismatch:** I/O video standards do not match.
- **Record Exception:** No space for saving recorded files or captured images.

Steps:

Enter **Exceptions** interface in Setup Menu and setup various exceptions.

Menu> Setup> Exceptions

Please refer to **Chapter 8.6** for detailed alarm response actions.

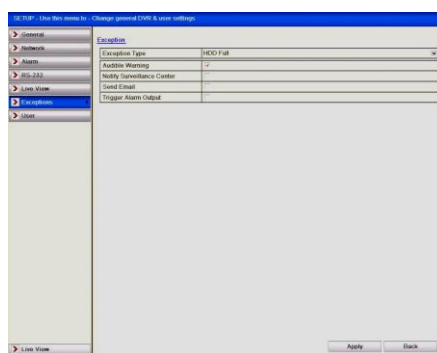

Figure 8.5 Exceptions Setup Interface

8.6 Setting Alarm Response Actions

Purpose:

Alarm responses will be activated when an alarm or exception occurs, including Full Screen Monitoring, Audible Warning (buzzer), Notify Surveillance Centre, Trigger Alarm Output and Send Email.

Full Screen Monitoring

When an alarm is triggered, the local monitor (HDMI, VGA or BNC monitor) will display in full screen view, the video image from the alarming channel configured for full screen monitoring.

If alarms are triggered simultaneously on several channels, their full-screen images will be switched at an interval of 10 seconds (default dwell time). A different dwell time can be set by going to **Menu > Setup > Live View > Full Screen Monitoring Dwell Time**.

Auto-switch will terminate once the alarm stops and you will be taken back to the Live View interface.

Note: You must select in “Trigger Channel” settings the channel(s) you want to make full screen monitoring.

Audible Warning

Trigger an audible beep when an alarm is detected.

Notify Surveillance Center

Sends an exception or alarm signal to remote alarm host when an event occurs. The alarm host refers to the PC installed with Remote Client.

Note: The alarm signal will be transmitted automatically at detection mode when remote alarm host is configured. Please refer to **Chapter 9** for details of alarm host configuration.

Send Email

Send an email with alarm information to a user or users when an alarm is detected. Please refer to **Chapter 9** for details of Email configuration.

Trigger Alarm Output

Trigger an alarm output when an alarm is triggered.

Enter Alarm Output interface.

Menu > Setup > Alarm > Alarm Output

Select an alarm output and set alarm name and dwell time.

Note: If “Manually Clear” is selected in the dropdown list of Dwell Time, you can clear it only by going to **Menu > Instant > Alarm**.

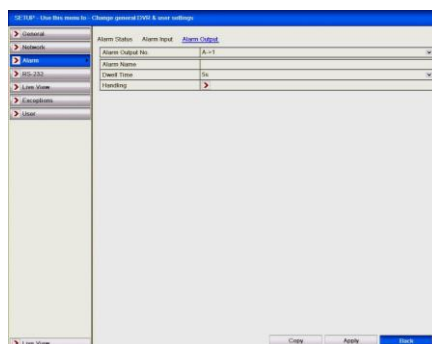

Figure 8.6a Alarm Output Setup Interface

Set up arming schedule of the alarm output.

Click **Handling** button to set the arming schedule of alarm output. Choose a day of the week and select from up to 8 time periods within the same day.

Note: Time periods must be consecutive and must not overlap.



Figure 8.6b Set Arming Schedule of Alarm Output

Repeat the above steps to setup arming schedule for other days of the week. You can also use **Copy** button to copy an arming schedule to other days. Click the **OK** button to complete the settings of the alarm output. You can also copy the above settings to another channel.

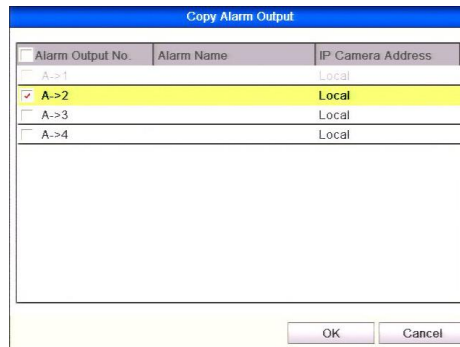

Figure 8.6c Copy Settings for Alarm Output

8.7 Triggering or Clearing Alarm Output Manually

Purpose:

Sensor alarm can be triggered or cleared manually. If “Manually Clear” is selected in the dropdown list of dwell time for an alarm output, the alarm can be cleared only by clicking **Clear** button in the following interface.

Steps:

Select the alarm output you want to trigger or clear and make related operations.

Menu> Instant> Alarm

Click **Trigger/Clear** button if you want to trigger or clear an alarm output.

Click **Trigger All** button if you want to trigger all alarm outputs.

Click **Clear All** button if you want to clear all alarm outputs.

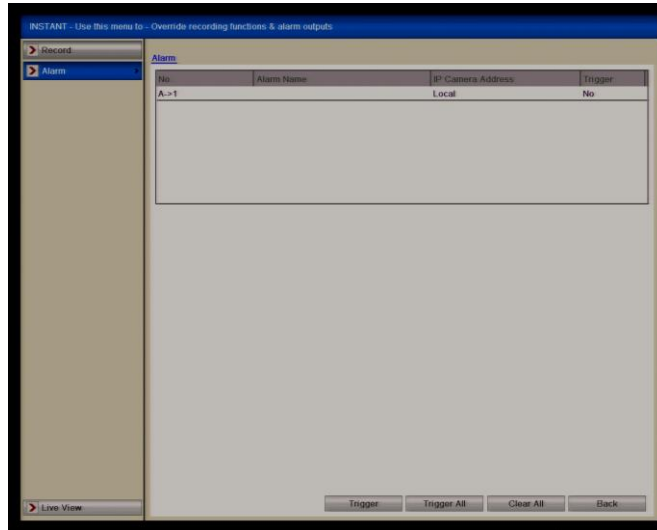

Figure 8.7a Clear or Trigger Alarm Output Manually

9. Network Settings

Purpose:

Network settings must be properly configured before you operate device over network.

9.1 General Settings

Steps:

Enter the Network Settings interface.

Menu > Setup > Network

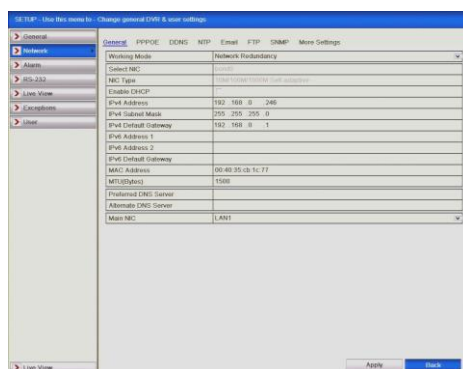

Figure 9.1a Network Settings Interface

Select the **General** tab.

In the **General Settings** interface:

In this DVR you can configure the following settings: NIC Type, IPv4 Address, IPv4 Gateway, MTU and DNS Server.

If the DHCP server is available, you can click the **DHCP** checkbox to automatically obtain an IP address and other network settings from that server.

Note: The valid value range of MTU is 500 ~ 1500.

After having configured the general settings, click the **Apply** button to save the settings.

9.2 Configuring PPPoE Settings

NOTE: PPPoE is not generally used in the UK and therefore not applicable.

Purpose:

Your device also allows access by Point-to-Point Protocol over Ethernet (PPPoE).

Steps:

Enter the **Network Settings** interface.

Menu > Setup > Network

Select the **PPPoE** tab to enter the PPPoE Settings interface.

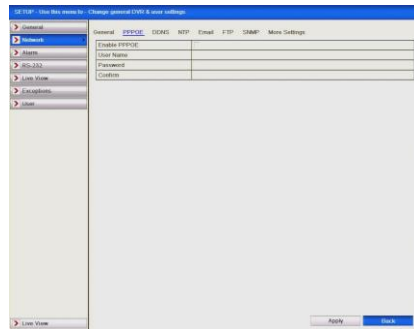

Figure 9.2a PPPoE Settings Interface

Check the **PPPoE** checkbox to enable this feature.

Enter **User Name**, **Password**, and **Confirm Password** for PPPoE access.

Note: The User Name and Password should be assigned by your ISP.

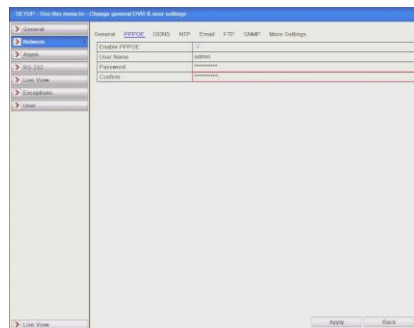

Figure 9.2b PPPoE Settings Interface

Click the **Apply** button to save and exit the interface.

After successful settings, the system asks you to reboot the device to enable the new settings, and the PPPoE dial-up is automatically connected after reboot.

You can go to **Menu > Tools > System Info > Network** interface to view the status of PPPoE connection.

9.3 Configuring DDNS

The Alien Hero models incorporate an independent Dynamic DNS updater service to resolve the router IP address when the router is not allocated a static IP address.

This service is called IPPOSTCODE and is now available for the ALIEN654, ALIEN658, ALIEN666, ALIEN674 and ALIEN678. Further information about other models will be advised when available.

Note: Standard Hero models require firmware v 2.2.8 build 130912 or later.

HD Hero models require firmware v 2.2.2 build 130906 or later.

The DVR needs to contact the server at ippostcode.com so must be able to resolve this name. To achieve this, a valid DNS server must be defined in the network settings.

You should use your own router's internal address whenever possible, eg: 192.168.0.1 or 192.168.1.1 or similar. Alternatively you may use a public DNS server 8.8.8.8.

Step 1. Enter a DNS Server Address

1. Navigate in the DVR's menu to the DNS entry; Menu > Setup > Network > Preferred DNS Server
2. Enter the appropriate Preferred DNS Server address (ideally your router's Default Gateway address). Whilst in the networking menu, check the Gateway field = your router's internal address should be the same.
3. Enter the appropriate Alternate DNS Server address: 8.8.8.8

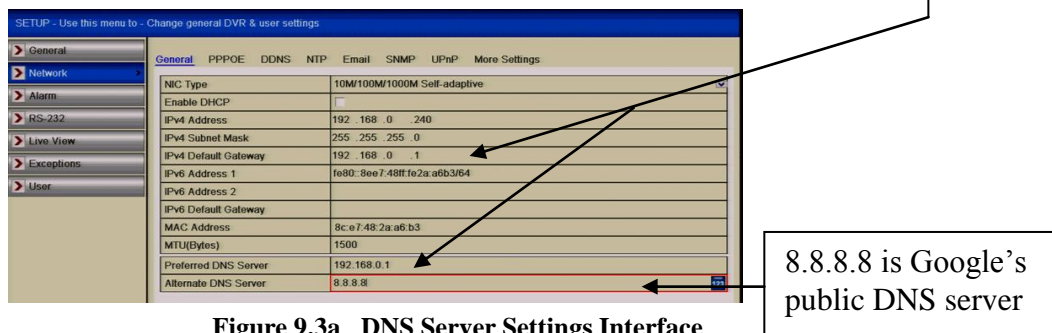

Figure 9.3a DNS Server Settings Interface

Step 2. Enable AlienDDNS

1. Enter the DVR's menu: Menu > Setup > Network > DDNS
2. Tick the DDNS checkbox
3. Ensure AlienDDNS is selected in the DDNS Type field
4. Leave the password field blank (This is entered in Step 3)
5. Enter a valid email address into the email field (you will receive an email)
6. Click Apply

The DVR should connect to ippostcode.com requesting a 'new' DNS record for itself, the server should respond with 'Record Created' and send you an email containing a password.

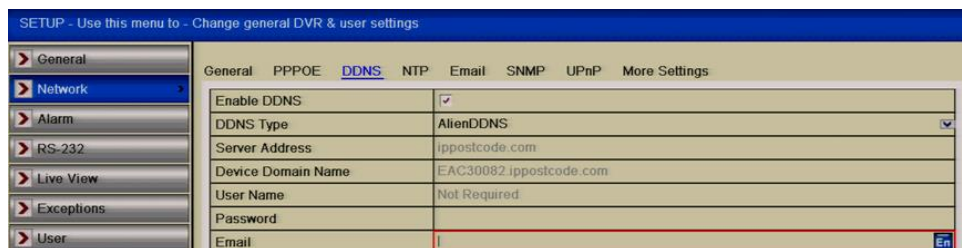

Figure 9.3b DDNS Settings Interface

Step 3. Enter your Alien DDNS Password

1. Enter the password from the email into the Alien DDNS 'password' entry field
2. Click Apply

The DVR should connect again, this time issuing an 'update' DNS request using the password, if successful the server responds with an 'Update successful' message, otherwise it returns an error message, eg: 'Invalid password', please check and try again. This update should take approximately 20 seconds.

Accessing the DVR

The domain name registered takes the form of the DVR's internal serial number followed by ippostcode.com, for example: dsw99999.ippostcode.com, you use this as a domain entry in CCTVWindow or the mobile clients instead of a numerical IP address.

A Word of Warning - Change the 'admin' Password

1. Given that Alien domains follow the same format '*serial-number.ippostcode.com*' it doesn't take much effort for a third party to locate your DVR on a trial and error basis. If you don't change the default admin password you are leaving the device wide open for public access.
2. Don't lose the new password; there is no backdoor otherwise the DVR will be coming back to us for engineer reset.

DynDNS:

Enter **Server Address** for DynDNS (e.g. members.dyndns.org).

In the **Device Domain Name** text field, enter the domain obtained from the DynDNS website.

Enter the **User Name** and **Password** registered in the DynDNS website.

The screenshot shows the 'SETUP' menu with 'Network' selected. The 'DDNS' tab is active, displaying the following settings:

Field	Value
Enable DDNS	<input checked="" type="checkbox"/>
DDNS Type	DynDNS
Server Address	members.dyndns.org
Device Domain Name	aliendvr.dyndns.org
User Name	alien
Password	*****
Confirm	*****

Figure 9.3c DynDNS Settings Interface

PeanutHull: Enter User Name and Password obtained from the PeanutHull website.

The screenshot shows the 'SETUP' menu with 'Network' selected. The 'DDNS' tab is active, displaying the following settings:

Field	Value
Enable DDNS	<input checked="" type="checkbox"/>
DDNS Type	PeanutHull
Server Address	
Device Domain Name	
User Name	allendvr
Password	*****
Confirm	*****

Figure 9.3d Peanut Hull Settings Interface

NO-IP:

Enter the account information in the corresponding fields. Refer to the DynDNS settings.

1. Enter **Server Address** for NO-IP.
2. In the **Device Domain Name** text field, enter the domain obtained from the NO-IP website (www.no-ip.com).

Enter the **User Name** and **Password** registered in the NO-IP website.

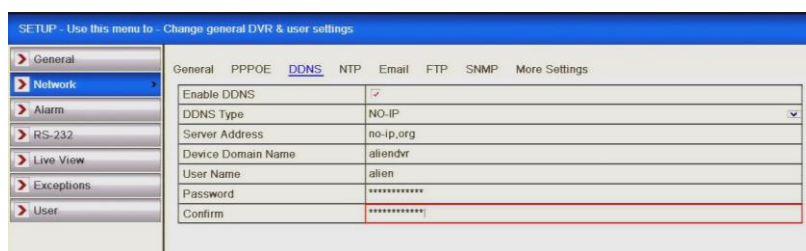

Figure 9.3e NO-IP Settings Interface

Click the **Apply** button to save and exit the interface.

AlienDNS: This service is not yet available.

Enter the **Server Address** of AlienDNS : www.ippostcode.com

Device Domain Name for AlienDNS : Not currently available.

A diagram will be available when service becomes available.

9.4 Configuring NTP Server

Purpose:

A Network Time Protocol (NTP) Server can be configured on your DVR to ensure the system date/time in the DVR matches the NTP server date and time.

Steps:

Enter the Network Settings interface.

Menu > Setup > Network > NTP

Select the **NTP** tab to enter the NTP Settings interface.

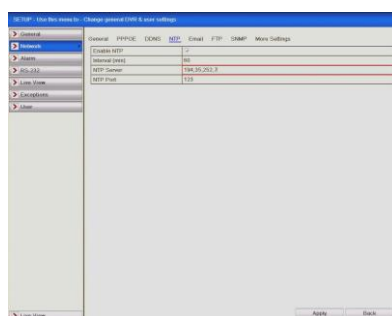

Figure 9.4a NTP Settings Interface

Check the **Enable NTP** checkbox to enable this feature.

Configure the following NTP settings:

Interval: Time interval period for the time check on the NTP server. See note below.

NTP Server: IP address of NTP server.

NTP Port: Port of NTP server.

Click the **Apply** button to save and exit the interface.

Note: The time synchronisation interval can be set from 1 to 10080 minutes and the default value is 60 minutes. If the device is connected to a public network, you should use an NTP server that has a time synchronisation function, such as the server at the National Time Center (IP Address: 210.72.145.44). If the device is setup in a more customised network, NTP software can be used to establish an alternative NTP server used for time synchronisation.

9.5 Configuring SNMP

Purpose:

You can use the SNMP protocol to get device status and parameter related information.

Steps:

Enter the Network Settings interface.

Menu > Setup > Network > SNMP

Select the **SNMP** tab to enter the SNMP Settings interface.

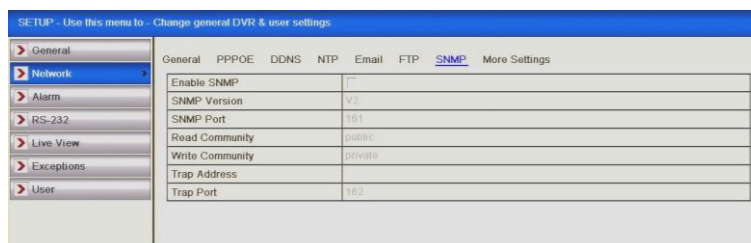

Figure 9.5a SNMP Settings Interface

Check the **SNMP** checkbox to enable this feature.

Configure the SNMP settings.

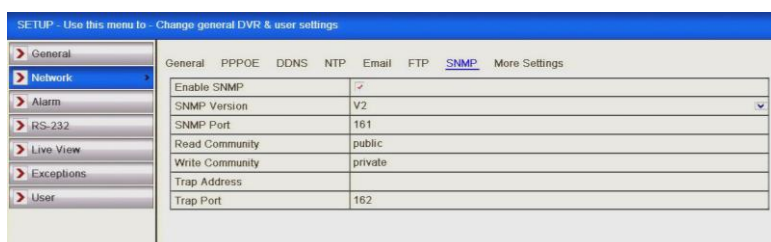

Figure 9.5b Configure SNMP Settings

Click the **Apply** button to save and exit the interface.

Note: Before setting the SNMP, please download the SNMP software to receive the DVR information via the SNMP port. By setting the Trap Address, the DVR is allowed to send the alarm event and exception message to the surveillance centre.

9.6 Configuring UPnP (Universal Plug and Play)

Purpose:

UPnP permits the DVR to discover the presence of other network devices on a remote network and establish functional network services for data sharing and communications by setting port forwarding automatically in the router. If you want to use the UPnP function you need to configure the UPnP parameters in the DVR.

Before you start:

If you enable the UPnP function in the DVR, you first must enable the UPnP function in the router to which your DVR is connected. This option is normally enabled in most current routers.

Steps:

1. Enter the Network Settings interface.
Menu > Setup > Network
2. Select the **UPnP** tab to enter the UPnP interface.

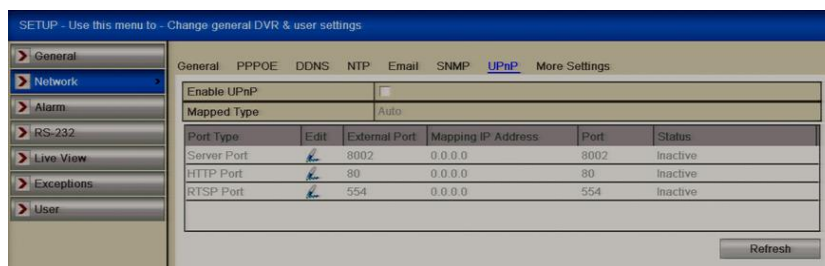



Figure 9.6a UPnP Settings Interface

3. Check checkbox to enable UPnP.
4. Set the Mapping Type to Auto or Manual.
When you select **Auto**, the mapping ports can be automatically assigned by the router. When you select **Manual**, you can edit the mapping ports required.
5. Click  to open the External Port Settings dialog box. Configure the external port No. for server port, HTTP port and RTSP port respectively.

Notes:

- 1) You can use the default Port No. or change it to actual requirements.
- 2) External Port indicates the port No. for port mapping in the router.
6. You can click **Refresh** to get the latest status of the port mapping.
7. Click the **Apply** button to save the settings.

9.7 Configuring Remote Alarm Host

This function is not available on this DVR. Use the Alarm software feature as detailed in the CCTVWindow client software manual.

9.8 Configuring Multicast

Purpose:

The multicast can be configured to display a live view for more than the maximum number of cameras on the network. A multicast address spans the Class-D IP range of 224.0.0.0 to 239.255.255.255. It is recommended to use the IP address ranging from 239.252.0.0 to 239.255.255.255.

Steps:

Enter the Network Settings interface.

Menu > Setup > Network

Select the **More Settings** tab to enter the More Settings interface.

Set **Multicast IP**. When adding a device to the client software, the multicast address must be the same as the device's multicast IP.

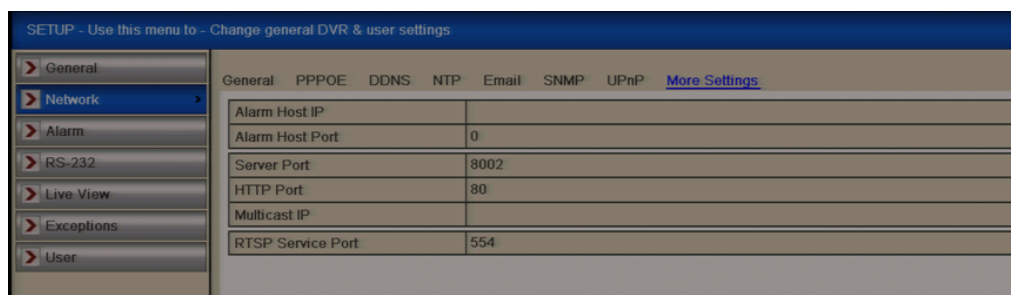

Figure 9.8a Configure Multicast

Click the **Apply** button to save and exit the interface.

9.9 Configuring RTSP

Purpose:

The RTSP (Real Time Streaming Protocol) is a network control [protocol](#) designed for use in entertainment and communications systems to control [streaming media servers](#).

Steps:

Enter the Network Settings menu using **Menu > Setup > Network > More Settings**
Select the **More Settings** tab to enter the More Settings menu.

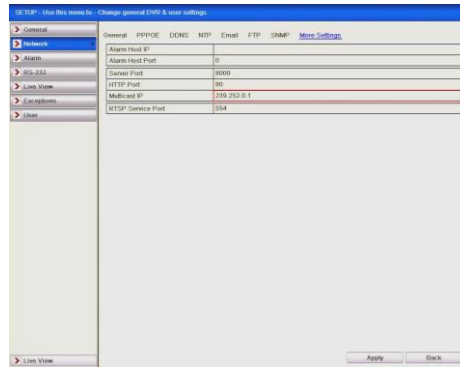

Figure 9.9a RTSP Settings Interface

Enter the RTSP port in the text field of **RTSP Service Port**. The default RTSP port is 554, but you can change it within the following ranges

554 or 1024 ~ 65535

Click the **Apply** button to save and exit the menu.

9.10 Configuring Server and HTTP Ports

Purpose:

You can change the server and HTTP ports in the Network Settings menu. The default server port is 8000 and the default HTTP port is 80.

Steps:

Enter the Network Settings interface.

Menu > Setup > Network > More Settings

Select the **More Settings** tab to enter the More Settings interface.

Enter new **Server Port** and **HTTP Port**.

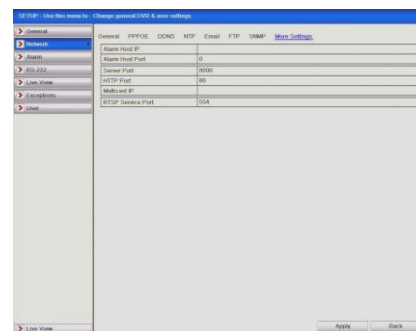

Figure 9.10a More Settings Menu

Enter the Server Port and HTTP Port in the text fields. The default Server Port is 8000 and the HTTP Port is 80, and you can change them according to the following ranges

Server Port 8000 or 2000 ~ 65535

HTTP Port 80 or 1 ~ 20, 22, 24 ~ 65535

Click the **Apply** button to save and exit the interface.

Note: The Server Port is used for remote client software access and the HTTP port and Server Port are used for remote IE access.

9.11 Configuring Email

Purpose:

The system can be configured to send an Email notification to all designated users if an alarm event is detected or a motion detection event is detected.

Before configuring the Email settings, the device must be connected to a local area network (LAN) that maintains an SMTP mail server. The network must also be connected to either an intranet or the Internet depending on the location of the Email accounts to which you want to send notification.

Steps:

Enter the Network Settings interface.

Menu > Setup > Network

Set the IPv4 Address, IPv4 Subnet Mask, IPv4 Gateway in the Network Settings menu.

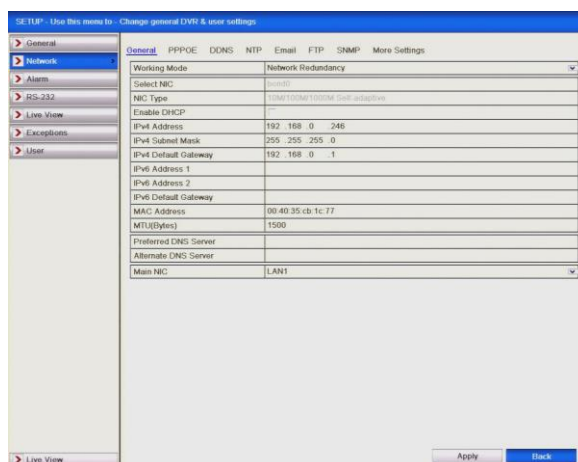

Figure 9.11a Network Settings Interface

Click the **Apply** button to save the settings.

Select the **Email** tab to enter the Email Settings interface.

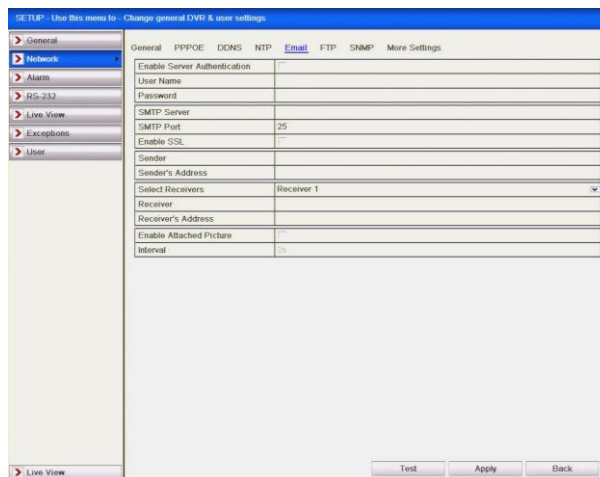

Figure 9.11b Email Settings Interface

Configure the following Email settings:

Enable Server Authentication (optional): Check the checkbox to enable the server authentication feature.

User Name: The user account of sender's Email for SMTP server authentication.

Password: The password of sender's Email for SMTP server authentication.

SMTP Server: SMTP Server IP address or host name (e.g. smtp.263xmail.com).

TIP: Best to use IP address. Establish by entering ping <host name>

SMTP Port: The SMTP port. The default TCP/IP port used for SMTP is 25.

Enable SSL (optional): Click the checkbox to enable SSL if required by the SMTP server.

Sender: The name of sender.

Sender's Address: The Email address of sender.

Select Receivers: Select the receiver. Up to 3 receivers can be configured.

Receiver: The name of user to be notified.

Receiver's Address: The Email address of user to be notified.

Enable Attached Pictures: Check the checkbox of **Enable Attached Picture** if you want to send email with attached alarm images.

Interval: The interval refers to the time between two actions of sending attached pictures.

You can click the **Test** button to test whether your Email settings work. The corresponding Attention message box will pop up.

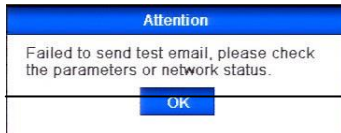

Figure 9.11c Email Testing Attention

9.12 Checking Network Traffic

Purpose:

You can check the network traffic to obtain real-time information of device such as linking status, MTU, sending/receiving rate, etc.

Steps:

Enter the Network Traffic interface.

Menu > Tools > Net Detect > Traffic

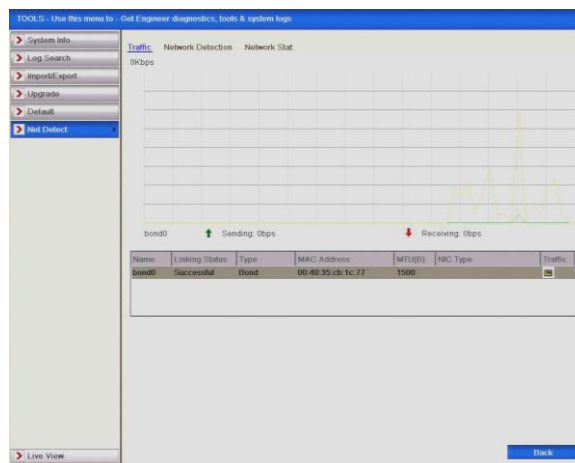

Figure 9.12a Network Traffic Interface

You can view the sending rate and receiving rate information on the interface. The traffic data is refreshed every 1 second.

9.13 Testing Network Delay and Packet Loss

Purpose:

You can obtain network connecting status of device through the network detection function, including network delay, packet loss, etc.

Steps:

Enter the Network Traffic interface.

Menu > Tools > Net Detect > Network Detection

Click the **Network Detection** tab to enter the Network Detection menu.

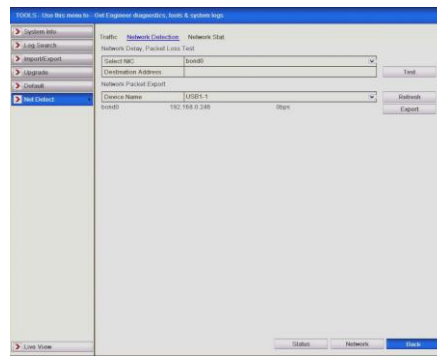

Figure 9.13a Network Detection Interface

Enter the destination address in the text field of **Destination Address**. Click the **Test** button to start testing network delay and packet loss. The testing result pops up on the window. If the testing is failed, the error message box will pop up as well.

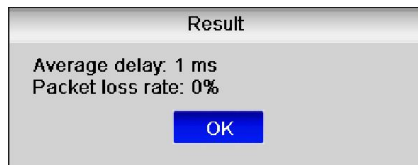

Figure 9.13b Testing Result of Network Delay



Figure 9.13c Testing Result for Packet Loss

9.14 Exporting Network Packet

Purpose:

By connecting the device to a network, the captured network data packet can be exported to a USB-flash drive and other local backup devices.

Steps:

Enter the Network Traffic interface.

Menu > Tools > Net Detect > Network Detection

Click the **Network Detection** tab to enter the Network Detection interface.

Select the backup device from the dropdown list in Device Name.

Note: Click the **Refresh** button if the connected local backup device cannot be displayed. If it fails to detect the backup device, please check whether it is compatible with the device. You can format the backup device if the format is incorrect.

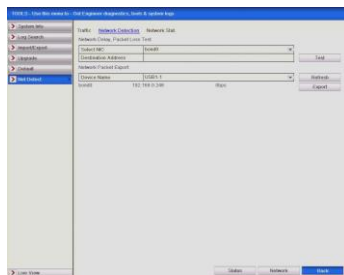

Figure 9.14a Export Network Packet

Click the **Export** button to start exporting.
 After the exporting is complete, click **OK** to finish the packet export.

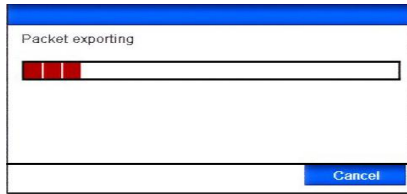

Figure 9.14b Packet Exporting



Figure 9.14c Packet Exporting completed

Note: Up to 1M data can be exported each time.

9.15 Checking Network Statistics

Purpose:

You can check the network status to obtain the real-time information of the device.

Steps:

Enter the HDD Information interface.

Menu > Tools > Net Detect > Network Stat

Click the **Network Stat.** tab to enter the Network Statistics menu.

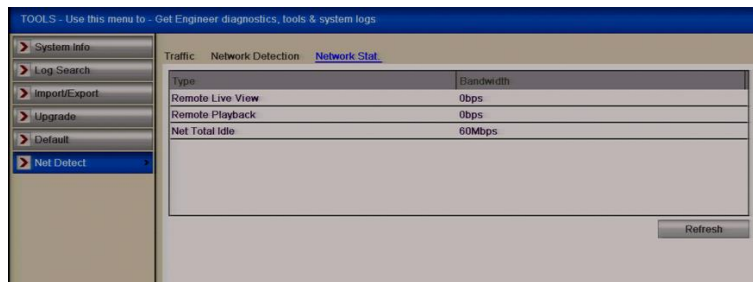

Figure 9.15a Network Stats. Interface

View the bandwidth of IP Camera, bandwidth of Remote Live View, bandwidth of Remote Playback and bandwidth of Net Total Idle information.

Click **Refresh** button to get the latest bandwidth statistics.

10. HDD Management

10.1 Initialising/Formatting HDDs

Purpose:

A newly installed hard disk drive (HDD) must be initialised before it can be used with your device.

Steps:

Enter the HDD Information interface.

Menu > Drives > General

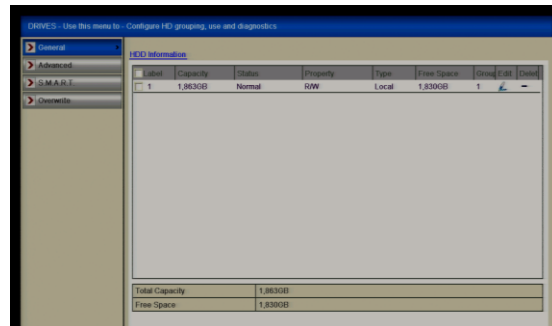

Figure 10.1a HDD Information Interface

Select HDD to be initialised.

Click the **Init** button.

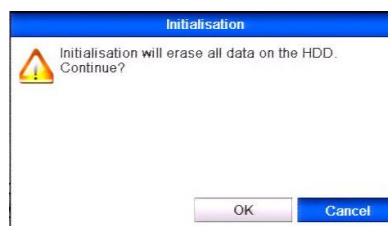

Figure 10.1b Confirm Initialisation

Select the **OK** button to start initialisation.

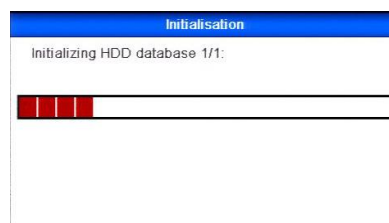

Figure 10.1c Start Initialisation

After the HDD has been initialised, the status of the HDD will change from **Uninitialised** to **Normal**.

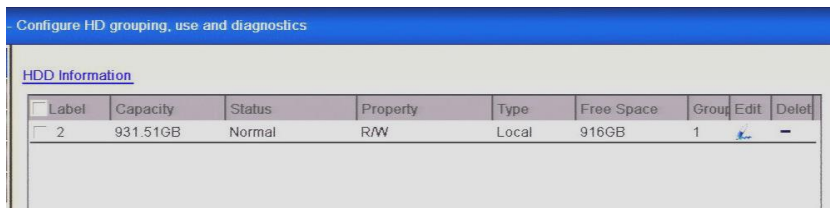

Figure 10.1d HDD Status Changes to Normal

Note: Initialising the HDD will erase all data on it.

10.2 Managing Network HDD

Purpose:

You can add the allocated NAS or IP SAN disk to DVR and use it as a network HDD.

Steps:

Enter the HDD Information interface.

Menu > Drives > General

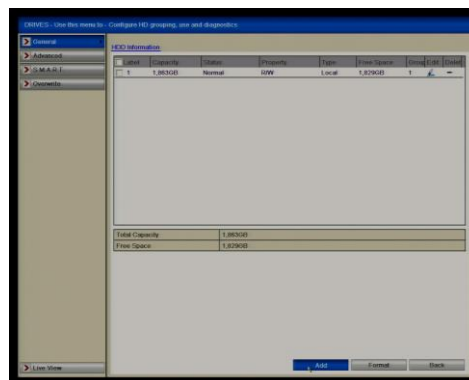

Figure 10.2a HDD Information Interface

Click the **Add** button to enter the Add NetHDD interface.

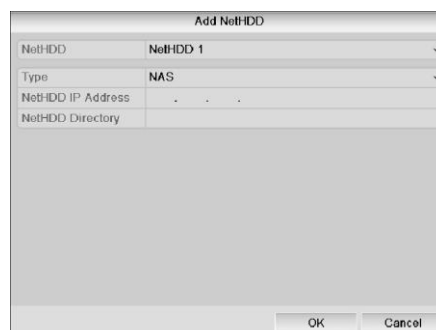

Figure 10.2b Adding NetHDD Interface

Add the allocated NetHDD.
 Select the type to NAS or IP SAN.
 Configure the NAS or IP SAN settings.

Add NAS disk:

Enter the NetHDD IP address in the text field.
 Enter the NetHDD Directory in the text field.
 Click the **OK** button to add the configured NAS disk.
Note: Up to 8 NAS disks can be added.

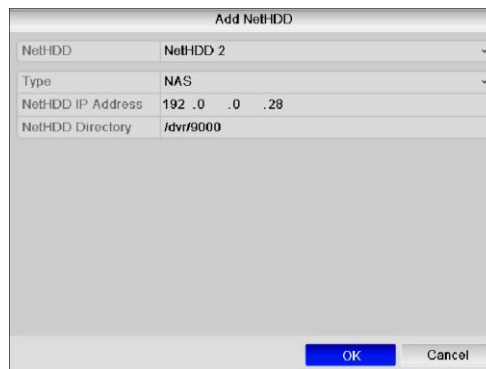

Figure 10.2c1 Add NAS Disk

Add IP SAN:

Enter the NetHDD IP address in the text field.
 Click the **Search** button on the available IP SAN disks.
 Select the IP SAN disk from the list shown below.
 Click the **OK** button to add the selected IP SAN disk.
Note: Only one IP SAN disk can be added.

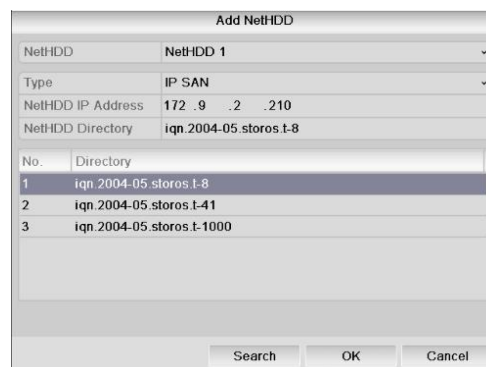

Figure 10.2c2 Add IP SAN Disk

After having successfully added the NAS or IP SAN disk, return to the HDD Information menu. The added NetHDD will then be displayed in the list.

Note: If the added NetHDD is uninitialised, please select it and click the **Init** button for initialisation.

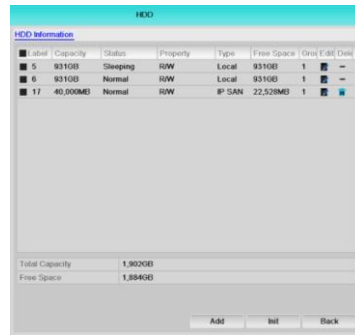

Figure 10.2d Initialise Added NetHDD

10.3 Setting HDD Groups

Purpose:

Multiple HDDs can be managed in groups. Video from specified channels can be recorded onto a particular HDD group through HDD settings.

Steps:

Enter the Storage Mode interface.

Menu > Drives > Advanced

Set the **Mode** to Group, as shown below.

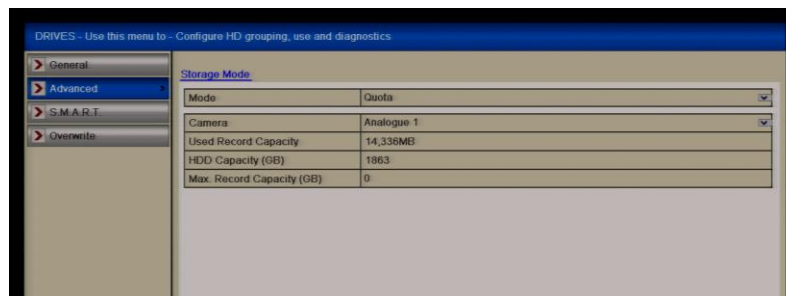

Figure 10.3a Storage Mode Interface

Click the **Apply** button and the following Attention box will display.

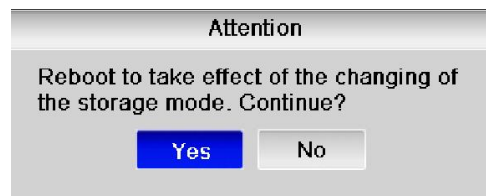

Figure 10.3b Attention for Reboot

Click the **Yes** button to reboot the device to activate the changes.

After reboot of device, enter the HDD Information interface.

Menu > Drives > General

Select HDD from the list and click the Edit icon to enter the Local HDD Settings interface.

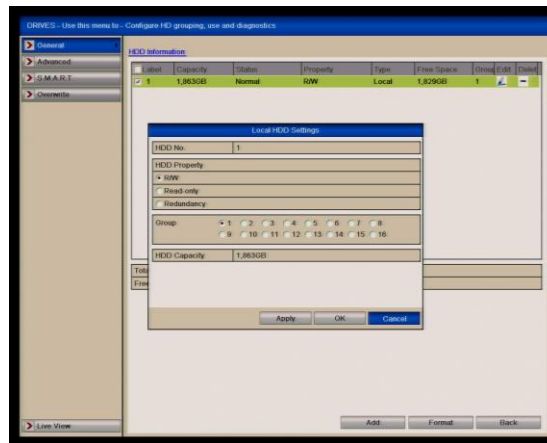

Figure 10.3c Local HDD Settings Interface

Select the Group number for the current HDD.
Note: The default group No. for each HDD is 1.
 Click the **OK** button to confirm the settings.
 In the Attention box, click the **Yes** button to finish the settings.

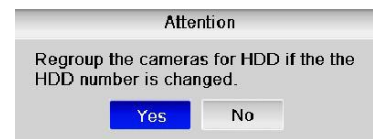

Figure 10.3d Confirm HDD Group Settings

10.4 Setting HDD Property

Purpose:

The HDD property can be set to redundancy, read-only or read/write (R/W). Before setting the HDD property, please set the storage mode to Group (refer to Chapter 10.3 Setting HDD Groups).

A HDD can be set to read-only to prevent important recorded files from being overwritten when the HDD becomes full in overwrite recording mode.

When the HDD property is set to redundancy, the video can be recorded both on the redundancy HDD and the R/W HDD simultaneously so as to ensure high security and reliability of video data.

Steps:

Enter the HDD Information interface.

Menu > Drives > General

Select HDD from the list and click the Edit icon to enter the Local HDD Settings interface.

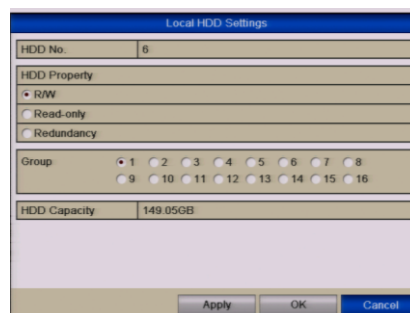

Figure 10.4a Set HDD Property

Set the HDD property to R/W, Read-only or Redundancy.

Click the OK button to save the settings and exit the interface.

In the HDD Information menu, the HDD property will be displayed in the list.

Note: At least 2 hard disks must be installed on your device when you want to set a HDD to Redundancy, and there is one HDD with R/W (Read/Write) capability.

10.5 Configuring Quota Mode

Purpose

Each camera can be configured with allocated quota for the storage of recorded files.

Steps

Enter the Storage Mode interface.

Menu > HDD > Advanced

Set the **Mode** to Quota.

Note: The device must be rebooted to enable the changes to take effect.

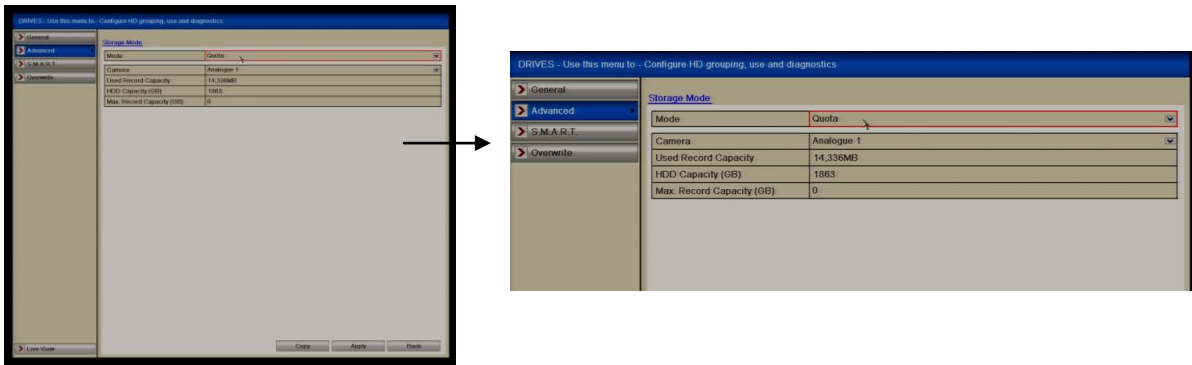

Figure 10.5a Storage Mode Settings Interface

Select a camera that you want to configure for quota. Enter the storage capacity in the text fields **Max. Record Capacity (GB)** as shown below.

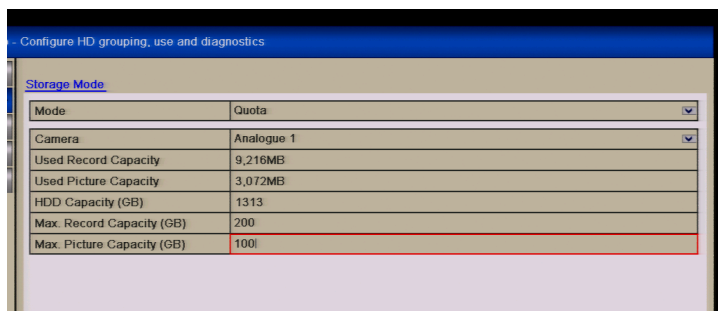

Figure 10.5b Configure Record Quota

You can copy the quota settings of the current camera to other cameras if required. Click the **Copy** button to enter the Copy Camera menu, as shown below.

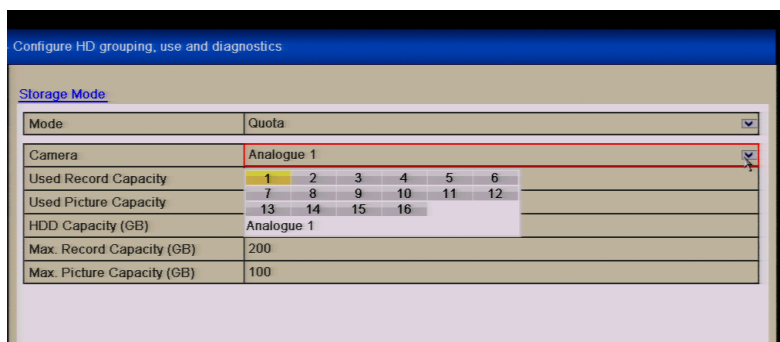

Figure 10.5c Copy Settings to Other Camera(s)

Select the camera (s) to be configured with the same quota settings. You can also click the checkbox for all **Analogue** cameras.

Click the **OK** button to finish the Copy settings and return to the Storage Mode interface.

Click the **Apply** button to apply the settings.

Note: If the quota capacity is set to **0**, then all cameras will use the total capacity of the HDD for recording.

10.6 Checking HDD Status

Purpose:

You may check the status of the installed HDDs on the DVR so as to take an immediate check in case of HDD failure.

Checking HDD Status in HDD Information Interface

Steps:

Enter the HDD Information interface.

Menu > Drives > General

Check the status of each HDD which is displayed on the list.

Label	Capacity	Status	Property	Type	Free Space	Group	Edit	Delete
6	149.05GB	Normal	R/W	Local	121GB	1		
8	465.76GB	Sleeping	Redundancy	Local	465GB	1		
9	698.64GB	Sleeping	R/W	eSATA	698GB	1		

Figure 10.6a View HDD Status (1)

Note: If the status of the HDD is **Normal** or **Sleeping** it is working normally. If the status is **Uninitialised** or **Abnormal**, please initialise (format) the HDD before use. If the HDD format fails, please replace HDD.

Checking HDD Capacity/Free Space in HDD Information Interface

Steps:

Enter the System Information interface.

Menu > Tools > System Info > Tools

Click the **HDD** tab to view the status of each HDD displayed on the list.

Label	Status	Capacity	Free Space	Property	Type	Group
6	Normal	149.05GB	105GB	R/W	Local	1
8	Sleeping	465.76GB	465GB	Redundancy	Local	1
9	Sleeping	698.64GB	698GB	R/W	eSATA	1

Figure 10.6b View HDD Status (2)

10.7 Checking S.M.A.R.T. Information / HDD Detect in HD models

Purpose:

The S.M.A.R.T. (Self-Monitoring, Analysis and Reporting Technology) is a monitoring system for the HDD that detects and reports on various indicators of reliability in the hope of anticipating a failure.

Steps:

Enter the S.M.A.R.T. Settings interface.

Menu > Drives > S.M.A.R.T.

Select the HDD to view its S.M.A.R.T. information list.

Note: If you want to use the HDD even when the S.M.A.R.T. check is displaying failed, you can select the checkbox before the **Use the disk when failed** item.

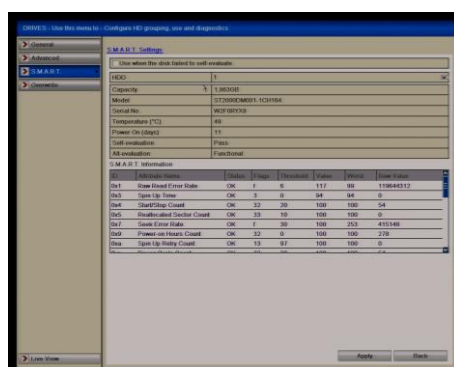

Figure 10.7a S.M.A.R.T. Settings Interface

10.8 Detecting Bad Sector

Note: This function is dependent on the model of DVR.

Purpose:

The bad sectors of a HDD may cause the system to slow down when reading or writing data. You can detect the bad sectors of the HDD and thus to take immediate measures to repair it.

Steps:

1. Enter the Bad Sector Detection interface.
Menu>Drives>S.M.A.R.T.>Bad Sector Detection
2. Select a HDD and click **Detect** to start detecting.
3. You can click **Pause** to pause the detection and click **Resume** to resume.
4. You can click **Error info** to view HDD error information.
5. On the HD models you can view damaged areas by a coloured graph that shows green for normal or red for damaged.

10.9 Configuring HDD Error Alarms

Purpose:

You can configure the HDD error alarms when the HDD status is **Uninitialised** or **Abnormal**.

Steps:

Enter the Exception interface.

Menu > Setup > Exceptions

Select the Exception Type **HDD Error** from the dropdown list.

Click the checkbox(s) below to select the HDD error alarm type (s), as shown below.

Note: The alarm type can be selected from: Audio Warning, Notify Surveillance Center, Send Email and Trigger Alarm Output.

Please refer to **Chapter 8 Setting Alarm Response Actions**.

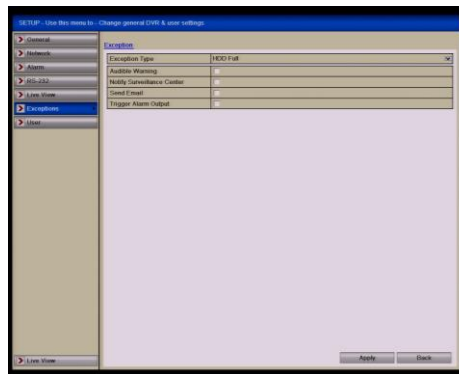

Figure 10.9a Configure HDD Error Alarm

When the Trigger Alarm Output is selected, you can also select the alarm output to be triggered from the list below.

Click the **Apply** button to save the settings.

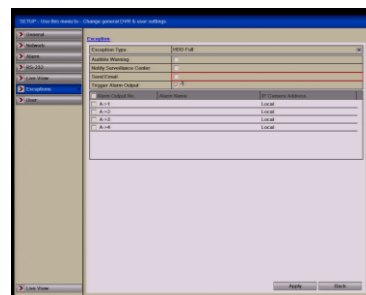

Figure 10.9b List of Alarm Outputs

11. Camera Settings

11.1 Configuring OSD Settings

Purpose:

You can configure the OSD (On-screen Display) settings for the camera, including date /time, camera name, etc.

Steps:

Enter the OSD Configuration interface.

Menu > Video > OSD

Select the camera to configure OSD settings.

Edit the Camera Name in the text field.

Configure the Display Name, Display Date and Display Week by clicking the checkbox.

Select the Date Format, Time Format and Display Mode.

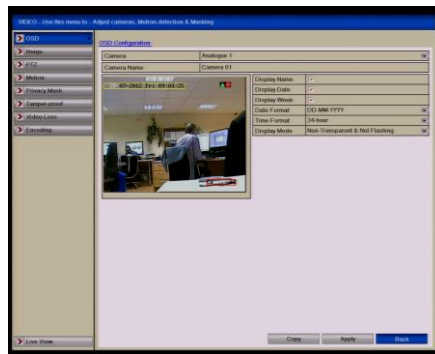

Figure 11.1a OSD Configuration Interface

You can use the mouse to click and drag the text frame on the preview window to adjust the OSD position.

Copy Camera Settings

If you want to copy the OSD settings of the current camera to other cameras, click the **Copy** button to enter the Copy Camera interface, as shown.

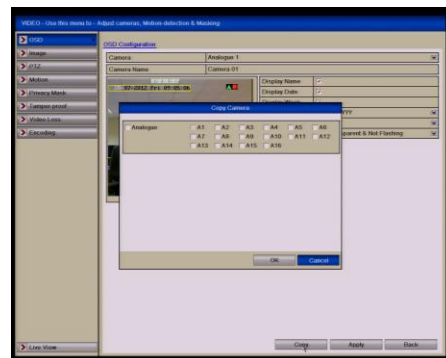

Figure 11.1b Copy Settings to Other Cameras

Select the camera (s) to be configured with the same OSD settings. You can also click the Analogue checkbox to select all cameras.

Click the **OK** button to finish the Copy settings and back to the OSD Configuration interface.

Click the **Apply** button to apply the settings.

Note: You can also click the Restore to restore the current OSD settings to the default parameters.

11.2 Configuring Privacy Mask

Purpose:

You are allowed to configure the four-sided privacy mask zones that cannot be viewed by the operator.

Steps:

Enter the Privacy Mask Settings interface.

Menu > Video > Privacy Mask

Select the camera to set privacy mask.

Click the checkbox of **Enable Privacy Mask** to enable this feature.

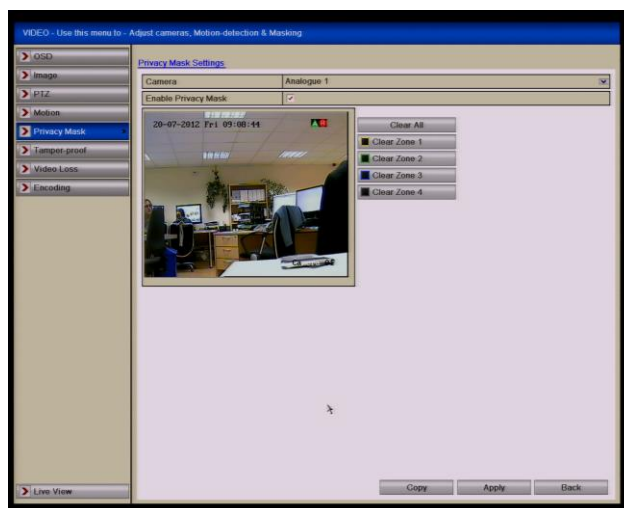

Figure 11.2a Privacy Mask Settings Interface

Use the mouse to draw a zone on the window. The zones will be marked with different frame colours.

Note: Up to 4 privacy mask zones can be configured, and the size of each area can be adjusted.

The configured privacy mask zones on the window can be cleared by clicking the corresponding Clear Zone1-4 icons on the right side of the window, or click **Clear All** to clear all zones.

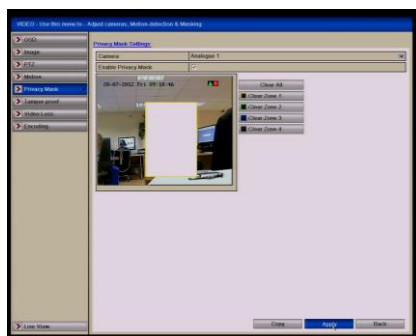

Figure 11.2b Set Privacy Mask Area

You can click the **Copy** button to copy the privacy mask settings of the current camera to other cameras. Please refer to **Chapter 11.1 Configuring OSD Settings**. Click the **Apply** button to save the settings.

11.3 Configuring Video Parameters

Steps:

Enter the Image Settings interface.

Menu > Video > Image

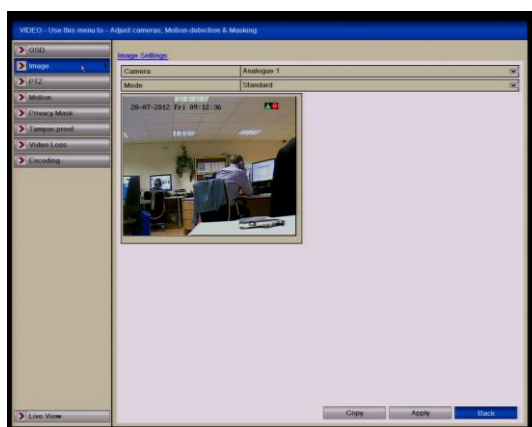

Figure 11.3a Image Settings Interface

Select the camera to set image parameters.

Select the mode from the dropdown list in **Mode**. Four modes are selectable: Standard, Indoor, Dim Light and Outdoor.

When the mode is selected for customising, you can adjust the video parameters, including Brightness, Contrast, Saturation, Hue, Sharpness and De-Noising.

Adjust the image parameters including the brightness, contrast, saturation, hue, sharpness and de-noising level by moving the sliding bar or increasing/decreasing the value.

Note: When you select different mode, corresponding default parameters are available. You can also adjust the value of the brightness, contrast, saturation and hue to 0~ 255, the sharpness to 0~ 15 and the denoising level to 0~ 5.

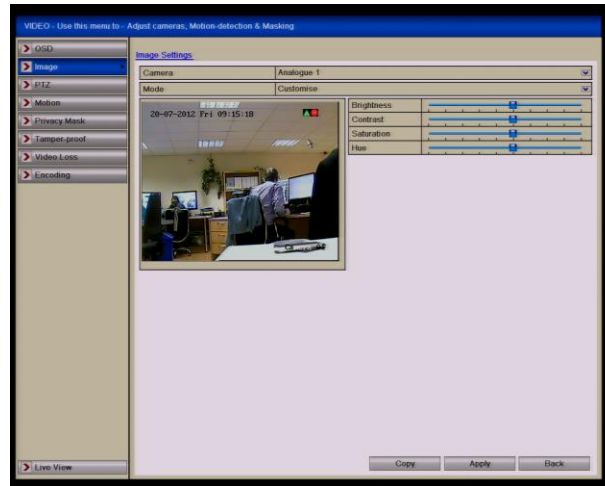

Figure 11.3b Configure Customised Image Settings

You can click the **Copy** button to copy the image settings of the current camera to other cameras. Please refer to **Chapter 11.1 Configuring OSD Settings**.

Click the **Apply** button to save the settings.

12. Device Management and Maintenance

12.1 Viewing Device Information

Steps:

Enter the System Information interface.

Menu > Tools > System Info > Device Info

Click the **Device Info** tab to enter the Device Information menu to view the device name, model, serial number, firmware version and encoding version.

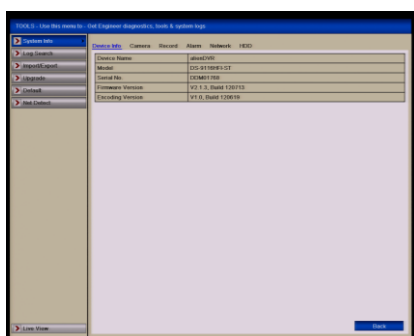

Figure 12.1a Device Information Interface

12.2 Viewing Camera Information

Steps:

Enter the System Information interface.

Menu > Tools > System Info > Camera

Click the **Camera** tab to enter the Camera Information menu to view the status of each camera, as shown in Figure 12.2a.

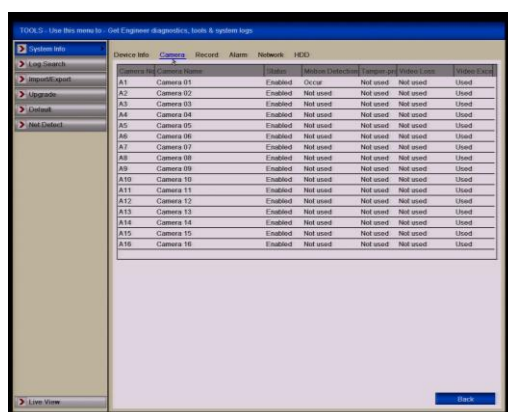

Figure 12.2a Camera Information Interface

12.3 Viewing Record Information

Steps:

Enter the System Information interface.

Menu > Tools > System Info > Record

Click the **Record** tab to enter the Record Information menu to view the recording status and encoding parameters of each camera.

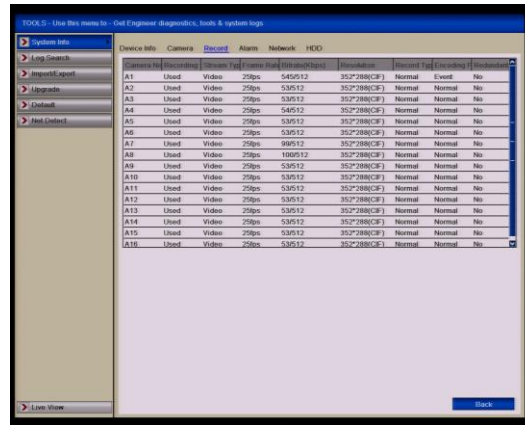

Figure 12.3a Record Information Interface

12.4 Viewing Alarm Information

Steps:

Enter the System Information interface.

Menu > Tools > System Info > Alarm

Click the **Alarm** tab to enter the Alarm Information menu to view the alarm information.

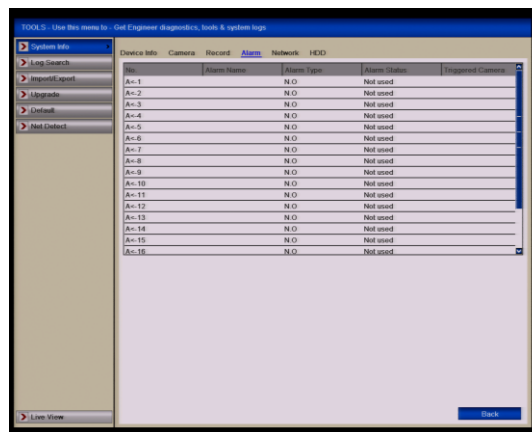

Figure 12.4a Alarm Information Interface

12.5 Viewing Network Information

Steps:

Enter the System Information interface.

Menu > Tools > System Info > Network

Click the **Network** tab to enter the Network Information menu to view the network information.

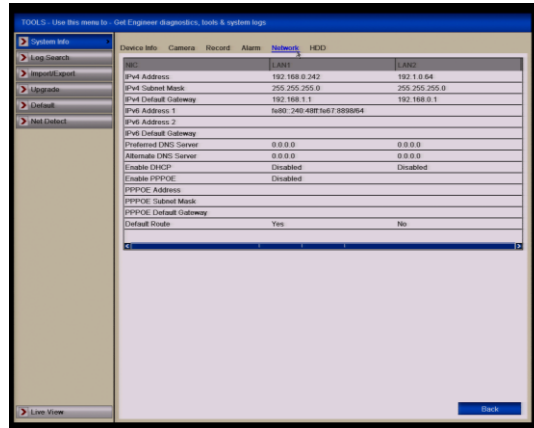

Figure 12.5a Network Information Interface

12.6 Viewing HDD Information

Steps:

Enter the System Information interface.

Menu > Tools > System Info > HDD

Click the **HDD** tab to enter the HDD Information menu to view the HDD status, free space, property, etc.

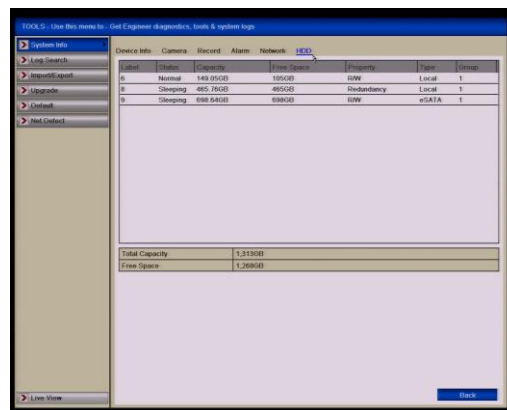

Figure 12.6a HDD Information Interface

12.7 Searching and Exporting Log Files

Purpose:

The operation, alarm, exception and information of the device can be stored in log files, which can be viewed and exported at any time.

Steps:

Enter the Log Search interface.

Menu > Tools > Log Search

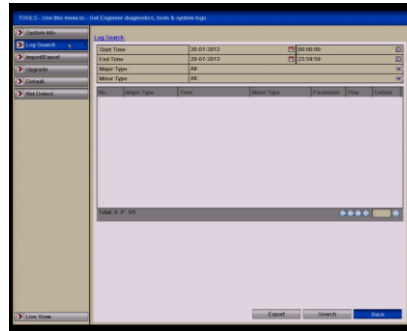

Figure 12.7a Log Search Interface

Set the log search conditions to refine your search, including the Start Time, End Time, Major Type and Minor Type.

Click the **Search** button to start searching log files.

The matched log files will be displayed on the list shown below.

Note: Up to 2000 log files can be displayed each time.

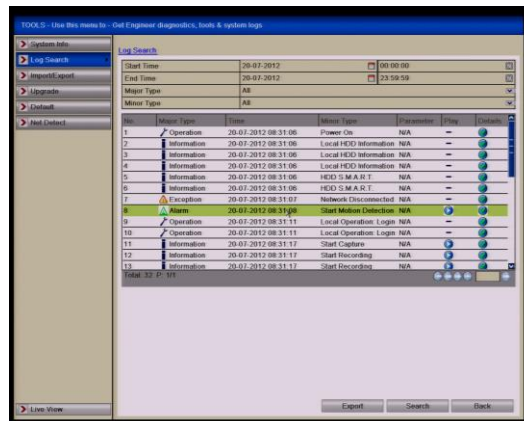

Figure 12.7b Log Search Results

You can click the  button of each log or double click it to view its detailed

information, as shown. Also you can click the  button to view the related video files if available.

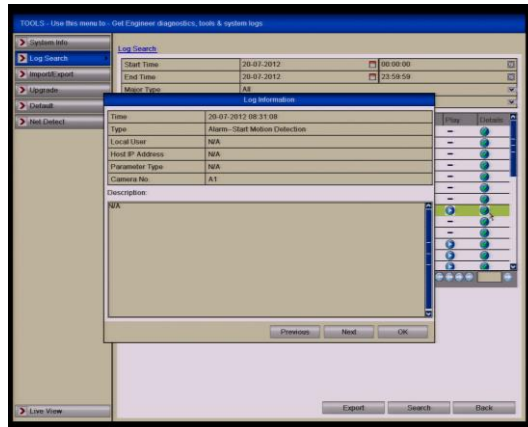

Figure 12.7c Log Details

If you want to export the log files, click the **Export** button to enter the Export menu.

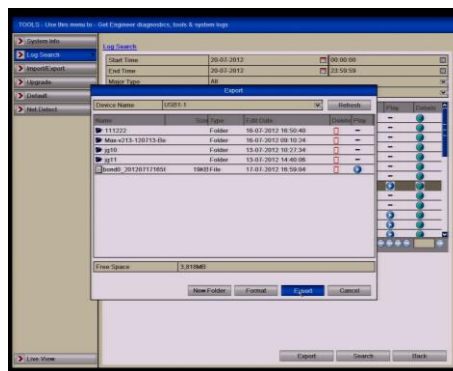

Figure 12.7d Export Log Files

Select the backup device from the dropdown list of **Device Names**.
 Click **Export** to export the log files to the selected backup device.
 You can click the **New Folder** button to create a new folder on the backup device or click the **Format** button to format the backup device before exporting log files.

Note:Please connect the backup device to the DVR before operating log export. The log files exported to the backup device are named by exporting time, e.g., **20110514124841logback.txt** (yyyymmddhhmmss)

12.8 Importing/Exporting Configuration Files

Purpose:

The configuration files of the device can be exported to local device for backup; and the configuration files of one device can be imported to multiple device devices if they are to be configured with the same parameters.

Steps:

Enter the Import/Export Configuration File interface.

Menu > Tools > Import/Export > Import/Export Config File

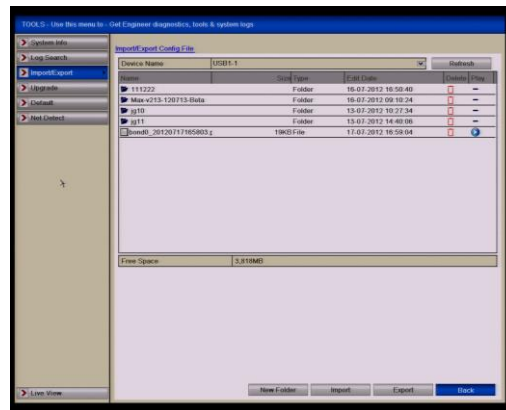

Figure 12.8a Import/Export Config File

Click the **Export** button to export configuration files to the selected local backup device. To import a configuration file, select the file from the selected backup device and click the **Import** button. After the import process is completed, you must reboot the device.

Note: After having finished the import of configuration files, the device will reboot automatically.

12.9 Restoring Default Settings

Steps:

Enter the Default interface.

Menu > Tools > Default

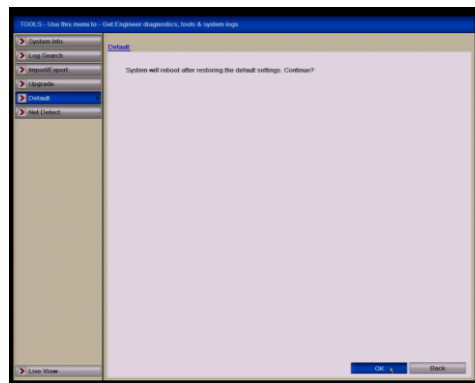

Figure 12.9a Restore Factory Default

Click the **OK** button to restore the default settings.

Note: Except for network parameters (including IP address, subnet mask, gateway, MTU, NIC working mode, default route and server port), all other parameters on the DVR will be restored to factory default settings.

13. Upgrading the Firmware

Warning: If you attempt to upgrade your DVR with wrong firmware it can completely destroy the unit and make it unusable.

Purpose:

The firmware on your device can be upgraded by local backup device or remote FTP server.

13.1 Upgrading by Local Backup Device

Steps:

Connect your device with a local backup device where the update firmware file is located.

Enter the Upgrade interface.

Menu > Tools > Upgrade > Local Upgrade

Click the **Local Upgrade** tab to enter the local upgrade menu.

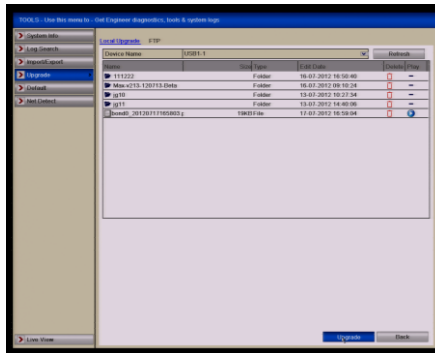

Figure 13.1a Local Upgrade Interface

Select the update file from the backup device.

Click the **Upgrade** button to start upgrading.

After the upgrading is complete, reboot the device to activate the new firmware.

13.2 Upgrading by FTP

Before you start:

Configure PC (running FTP server) and DVR on the same Local Area Network. Run the 3rd-party TFTP software on the PC and copy the firmware into the root directory of TFTP.

Steps:

Enter the Upgrade interface.

Menu > Tools > Upgrade > FTP

Click the **FTP** tab to enter the local upgrade interface, as shown below.

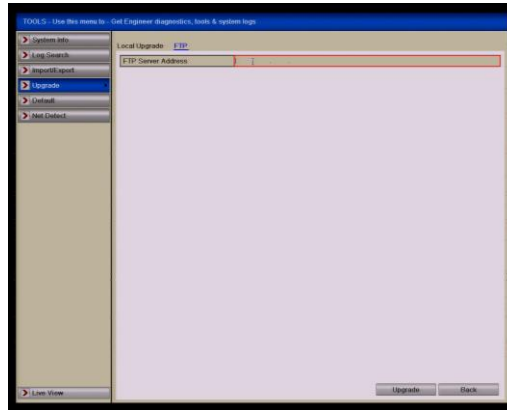

Figure 13.2a FTP Upgrade Interface

Enter the FTP Server Address in the text field.

Click the **Upgrade** button to start upgrading.

After the upgrading is complete, reboot the device to activate the new firmware.

14. Configuring Other Settings

14.1 Configuring General Settings

Purpose:

You can configure the BNC output standard, VGA/HDMI output resolution, mouse pointer speed, etc.

Steps:

Enter the General Settings interface.

Menu > Setup > General > General

Select the **General** tab.

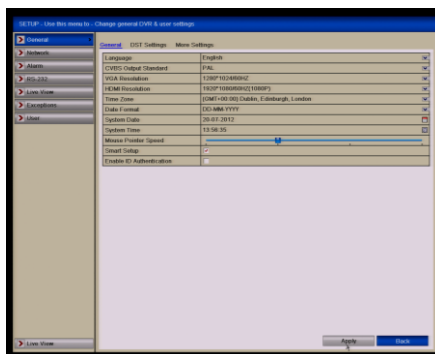

Figure 14.2a General Settings Interface

Configure the following settings:

Language: The default language used is **English**.

CVBS Output Standard: Select the CVBS output standard i.e NTSC or PAL. PAL is used in the UK.

VGA Resolution: Select the VGA/HDMI output resolution, which must be the same as the resolution of the monitor screen.

Time Zone: Select the time zone.

Date Format: Select the date format.

System Date: Select the system date.

System Time: Select the system time.

Mouse Pointer Speed: Set the mouse pointer speed; 4 levels are configurable.

Enable Wizard: Enable/disable the Wizard when the device starts up.

Enable Password: Enable/disable the use of the login password.

Click the **Apply** button to save the settings.

14.2 Configuring RS232 Serial Port

Purpose:

The RS-232 port can be used in two ways:

Parameter Configuration: Connect a PC to the device through the PC serial port. DVR parameters can be configured by using software such as HyperTerminal. The serial port parameters must be the same as the DVR's when connecting with the PC serial port.

Transparent Channel: Connect a serial device directly to the DVR. The serial device will be controlled remotely by the PC through the network and the protocol of the serial device.

Steps:

Enter the RS232 Settings interface.

Menu > Setup > RS-232

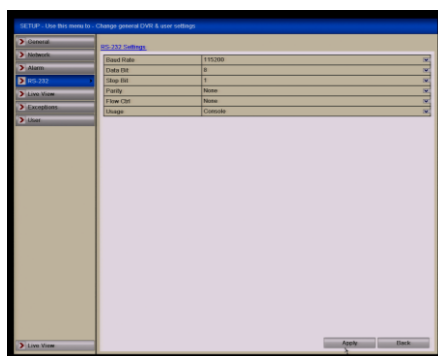

Figure 14.1 RS-232 Settings Interface

Configure RS232 parameters, including baud rate, data bit, stop bit, parity, flow control and usage.

Click the **Apply** button to save the settings.

14.3 Configuring DST Settings

Daylight Saving Time changes

Steps:

Enter the General Settings interface.

Menu > Setup > General > DST Settings

Choose **DST Settings** tab. You can click the checkbox before the **Auto DST Adjustment** item. Alternatively you can manually check **Interface** the Enable DST checkbox and then you choose the dates of the DST period.

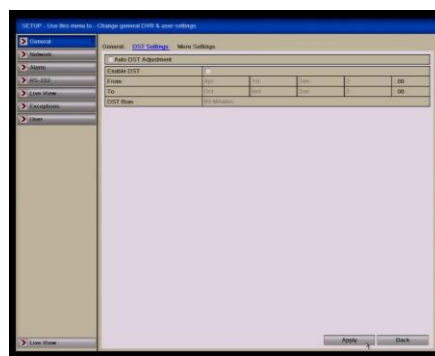

Figure 14.3a DST Settings

14.4 General More Settings

Steps:

Enter the General Settings interface.

Menu > Setup > General > More Settings

Click the **More Settings** tab to enter the More Settings interface.

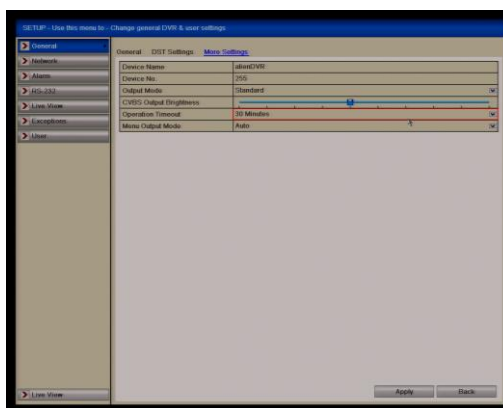

Figure 14.4a More Settings Interface

Configure the following settings:

Device Name: Edit the name of device.

Device No.: Edit the serial number of device. The Device No. can be set in the range of 1~255, and the default No. is 255.

Output Mode: Select the output mode to: Standard, Bright, Gentle or Vivid.

CVBS Output Brightness: Adjust the video output brightness.

Operation Timeout: Set timeout time for menu inactivity. E.g. when the timeout time is set to 5 Minutes, then the system will exit from the current operation menu to live view screen after 5 minutes of menu inactivity.

Menu Output Mode: You can select from Auto, HDMI/VGA or Main CVBS.

Note: When you select Auto, the device can automatically detect the HDMI/VGA output as the main output and the CVBS as the auxiliary output, when the DVR starts up. If you change the output mode you must restart the DVR to activate the new settings.

Click the **Apply** button to save the settings.

15. Managing User Accounts

Purpose:

There is a default account in the DVR: **Administrator**. The **Administrator** user name is **admin** and the password is **12345**. The **Administrator** has the permission to add and delete users and configure user parameters.

15.1 Adding a User

Steps:

Enter the User Management interface.

Menu > Setup > User > User Management

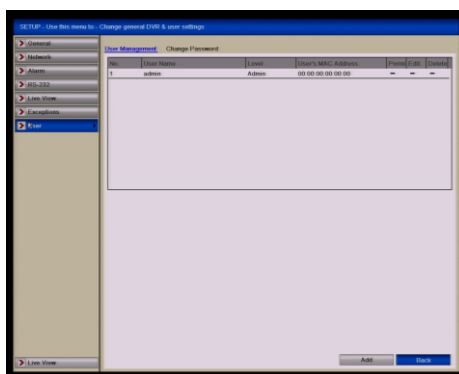

Figure 15.1a User Management Interface

Click the **Add** button to enter the Add User interface.

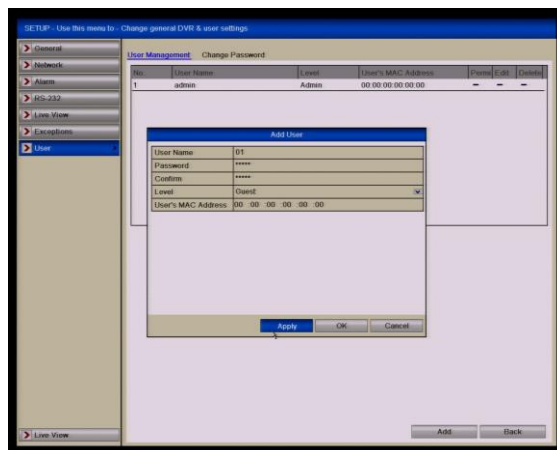

Figure 15.1b Add User Menu

Enter the information for new user, including **User Name**, **Password**, **Level** and **User's MAC Address**.

Level: Set the user level to **Operator** or **Guest**. Different user levels have different operating permissions.

Operator: The **Operator** user level has permission for a Local Log Search in Local Configuration, Remote Log Search, Two-way Audio in Remote Configuration and all operating permissions in the Camera Configuration.

Guest: The Guest user has permission for Local Log Search in Local Configuration, Remote Log Search in Remote Configuration but only has local/remote playback in the Camera Configuration.

User's MAC Address: The MAC address of the remote PC which logs onto the device. If it is configured and enabled, it only allows the remote user with this MAC address to access the device.

Click the **OK** button to save the settings and go back to the User Management interface. The added new user will be displayed on the list, as shown below.

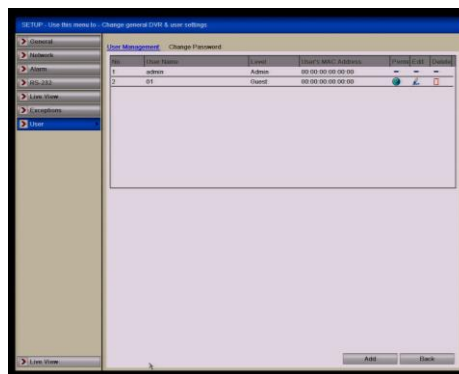



Figure 15.1c Added User Listed in User Management Interface

Select the user from the list and then click the  button to enter the Permission settings interface, as shown in Figure 15.1d & Figure 15.1e.

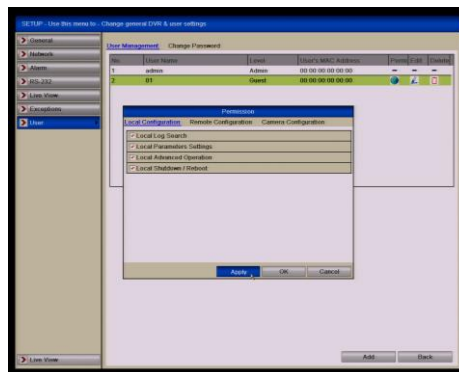

Figure 15.1d User Permission Settings Interface

Set the operating permission of Local Configuration, Remote Configuration and Camera Configuration for the user.

Local Configuration

Local Log Search: Searching and viewing logs and DVR system information.

Local Parameters Settings: Configuring parameters, restoring factory default parameters and importing/exporting configuration files.

Local Advanced Operation: Operating HDD management (initialising HDD, setting HDD property), upgrading system firmware, clearing I/O alarm output.

Local Shutdown /Reboot: Shutting down or rebooting the device.

Remote Configuration

Remote Log Search: Remotely viewing logs that are saved on the DVR.

Remote Parameters Settings: Remotely configuring parameters, restoring factory default parameters and importing/exporting configuration files.

Remote Serial Port Control: Configuring settings for RS-232 and RS-485 ports.

Remote Video Output Control: Sending remote control panel signal.

Two-Way Audio: Operating two-way audio between remote client and DVR.

Remote Alarm Control: Remotely arming (notify alarm and exception message to the remote client) and controlling the alarm output.

Remote Advanced Operation: Remotely operating HDD management (initialising HDD, setting HDD property), upgrading system firmware, clearing I/O alarm output.

Remote Shutdown/Reboot: Remotely shutting down or rebooting the device.

Camera Configuration

Remote Live View: Remotely viewing live video for selected camera/s.

Local Manual Operation: Locally starting/stopping manual recording and alarm output for selected camera/s.

Remote Manual Operation: Remotely starting/stopping manual recording and alarm output for selected camera/s.

Local Playback: Locally playing back recorded files for selected camera/s.

Remote Playback: Remotely playing back recorded files for selected camera/s.

Local PTZ Control: Locally controlling PTZ movement for selected camera/s.

Remote PTZ Control: Remotely controlling PTZ movement for selected camera/s.

Local Video Export: Locally exporting recorded files for selected camera/s.

Click the **OK** button to save the settings and exit interface.

Note: Only the **admin** user account has the permission for restoring factory default parameters.

15.2 Deleting a User

Steps:

Enter the User Management interface.

Menu > Setup > User

Select the user to be deleted from the list, as shown below.

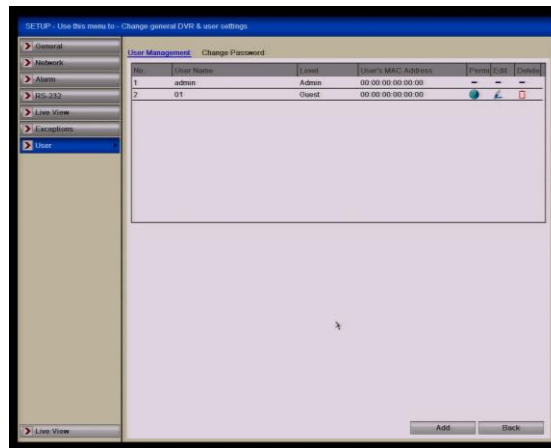



Figure 15.2a Delete a User

Click the  icon to delete the selected user.

15.3 Editing a User

Steps:

Enter the User Management interface.

Menu > Setup > User

Select the user to be edited from the list as shown below.

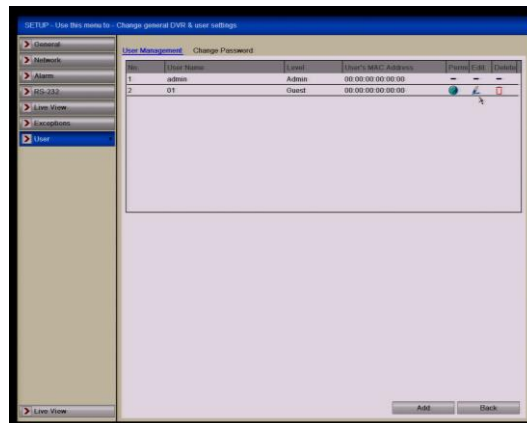

Figure 15.3a Edit a User

Click the  icon to enter the Edit User interface, as shown below.

Edit User	
User Name	01
Password	*****
Confirm	*****
Level	Guest
User's MAC Address	00 : 00 : 00 : 00 : 00 : 00

Figure 15.3b Edit User Interface

Edit the user information, including user name, password, level and MAC address. Click the **OK** button to save the settings and exit the menu.

15.4 Changing Password of Admin

Purpose:

The password of the **admin** user account can be changed in the User Management menu.

Steps:

Enter the User Management interface.

Menu > Setup > User > Change Password

Click the **Change Password** tab to enter the Change Password menu, as shown below.

User Management: Change Password	
User Name	admin
Old Password	:
New Password	:
Confirm	:
MAC Address	00 : 00 : 00 : 00 : 00 : 00

Figure 15.4a Change Password

Enter the old password, new password and confirm password in the menu. Click the **Save** button to save the changes.

15.5 Logging off / Shutting down / Rebooting DVR

Enter the Shutdown option

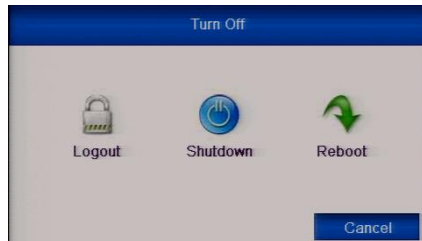

Figure 15.5a Turn Off Menu



Figure 15.5b Main Menu

Click Logout to log out, Shutdown to shutdown DVR or Reboot to reboot DVR.

16. Glossary

Dual Stream: Dual stream is a technology used to record high resolution video locally while transmitting a lower resolution stream over the network. The two streams are generated by the device, with the main stream having a maximum resolution of 4CIF (1080P HD models) and the sub-stream having a maximum resolution of CIF.

DVR: Acronym for Digital Video Recorder. A DVR is device that is able to accept video signals from analogue cameras, compress the signal and store it on its hard drives.

HDD: Acronym for Hard Disk Drive. A storage medium which stores digitally encoded data on platters with magnetic surfaces.

DHCP: Dynamic Host Configuration Protocol (DHCP) is a network application protocol used by devices (DHCP clients) to obtain configuration information for operation in an Internet Protocol network.

HTTP: Acronym for Hypertext Transfer Protocol. A protocol to transfer hypertext request and information between servers and browsers over a network

PPPoE: PPPoE, Point-to-Point Protocol over Ethernet, is a network protocol for encapsulating Point-to-Point Protocol (PPP) frames inside Ethernet frames. It is used mainly with ADSL services where individual users connect to the ADSL transceiver (modem) over Ethernet and in plain Metro Ethernet networks.

DDNS: Dynamic DNS is a method, protocol, or network service that provides the capability for a networked device, such as a router or computer system using the Internet Protocol Suite, to notify a domain name server to change, in real time (ad-hoc) the active DNS configuration of its configured hostnames, addresses or other information stored in DNS.

Hybrid DVR: A hybrid DVR is a combination of a DVR and NVR.

NTP: Acronym for Network Time Protocol. A protocol designed to synchronise the clocks of computers over a network.

NTSC: Acronym for National Television System Committee. NTSC is an analogue television standard used in such countries as the United States and Japan. Each frame of an NTSC signal contains 525 scan lines at 60Hz.

NVR: Acronym for Network Video Recorder. An NVR can be a PC-based or embedded system used for centralised management and storage for IP cameras, IP Domes and other DVRs.

PAL: Acronym for Phase Alternating Line. PAL is also another video standard used in broadcast televisions systems in large parts of the world. PAL signal contains 625 scan lines at 50Hz.

PTZ: Acronym for Pan, Tilt, Zoom. PTZ cameras are motor driven systems that allow the camera to pan left and right, tilt up and down and zoom in and out.

USB: Acronym for Universal Serial Bus. USB is a plug-and-play serial bus standard to interface devices to a host computer.

17. Frequently Asked Questions

Why does my device make a beeping sound after booting?

The possible reasons for the warning beep on the device are as follows:

There is no HDD installed in the device, or the HDD is not initialised or HDD error.

To cancel the beeping sound and use the device without HDD, enter the Menu > Setup > Exceptions and Exception Type and click on the down arrow key and select Record Exception.

Why does the device seem unresponsive when operating with the IR remote control?

Please read through the section **Using the IR Remote Control**, and check:

The batteries are installed correctly in the remote, making sure that the polarities of the batteries are not reversed, the batteries are not flat and the remote has not been tampered with. Also check there are no fluorescent lamps in use nearby.

Why does the PTZ camera telemetry not work?

If the PTZ seem unresponsive, please check:

The RS-485 cable is properly connected according to polarity and the protocol, baud rate and ID in the DVR PTZ menu, matches the settings in the PTZ camera.

Why is there no video recorded after setting the motion detection?

If there is no recorded video after setting the motion detection, please check:

The record schedule is setup correctly by following the steps listed in **Configuring Record**.

The motion detection area is not configured correctly (See **Configuring Motion Detection**).

The correct channels are not being triggered for motion detection (See **Configuring Motion Detection**).

Why doesn't the DVR detect my USB device for exporting recorded files?

There is a chance that the DVR and the USB device are not compatible. Try formatting to FAT32 in a PC first and if still having problems try an alternative brand of device.

My DVR is in Live View mode and the menu does not display. It does not respond to the mouse, the front panel, the remote or keyboard.

On the standard DVR your device may be in auxiliary mode. This occurs when the **Main/Spot** button is pressed on the front panel. To return to the previous mode of operation, press the **Main/Spot** button again and then press **Enter** button on the front panel. Alternatively leave the monitor connected and powered up, ensuring any other monitor or monitor cable is disconnected from the DVR and just reboot the DVR only.

18. Record Timings

18.1 Record Timings for 16 channels - Alien666

CIF mode

Frame Rate	HDD 500Gb	HDD 1.0Tb	HDD 2.0Tb	HDD 3.0Tb	HDD 4.0Tb
25	5dy 3hr	10dy 7hr	20dy 14hr	30dy 21hr	41dy 4hr
12	10dy 7hr	20dy 14hr	41dy 5hr	61dy 18hr	82dy 10hr
6	20dy 14hr	41dy 5hr	82dy 10hr	123dy 15hr	164dy 20hr
4	27dy 11hr	54dy 23hr	109dy 22hr	164dy 21hr	219dy 20hr
2	54dy 23hr	109dy 2hr	219dy 20hr	327dy 6hr	439dy 16hr
1	82dy 10hr	164dy 1hr	329dy 18hr	492dy 3hr	759dy 12hr

2CIF mode

Frame Rate	HDD 500Gb	HDD 1.0Tb	HDD 2.0Tb	HDD 3.0Tb	HDD 4.0Tb
25	2dy 14hr	5dy 3hr	10dy 7hr	15dy 11hr	20dy 14hr
12	5dy 3hr	10dy 7hr	20dy 14hr	30dy 22hr	41dy 5hr
6	10dy 7hr	20dy 14hr	41dy 5hr	61dy 20hr	82dy 10hr
4	13dy 16hr	27dy 11hr	54dy 23hr	82dy 10hr	109dy 22hr
2	27dy 11hr	54dy 23hr	109dy 22hr	164dy 21hr	219dy 20hr
1	54dy 23hr	82dy 10hr	164dy 21hr	247dy 8hr	329dy 18hr

4CIF mode

Frame Rate	HDD 500Gb	HDD 1.0Tb	HDD 2.0Tb	HDD 3.0Tb	HDD 4.0Tb
25	1dy 7hr	2dy 14hr	5dy 3hr	7dy 17hr	10dy 6hr
12	2dy 14hr	5dy 3hr	10dy 7hr	15dy 10hr	20dy 14hr
6	5dy 3hr	10dy 7hr	20dy 14hr	30dy 22hr	41dy 5hr
4	6dy 20hr	20dy 14hr	27dy 11hr	41dy 5hr	54dy 23hr
2	13dy 16hr	27dy 11hr	54dy 23hr	82dy 10hr	109dy 22hr
1	27dy 8hr	54dy 23hr	82dy 10hr	123dy 16hr	164dy 21hr

18.2 Record Timings for 8 channels - Alien658

CIF mode

Frame Rate	HDD 500Gb	HDD 1.0Tb	HDD 2.0Tb	HDD 3.0Tb	HDD 4.0Tb
25	10dy 7hr	20dy 14hr	41dy 4hr	61dy 18hr	82dy 8hr
12	20dy 14hr	41dy 5hr	82dy 10hr	123dy 15hr	164dy 20hr
6	41dy 5hr	82dy 10hr	164dy 20hr	247dy 6hr	329dy 16hr
4	54dy 23hr	109dy 22hr	219dy 20hr	329dy 20hr	439dy 16hr
2	109dy 22hr	219dy 20hr	439dy 16hr	659dy 12hr	879dy 8hr
1	164dy 21hr	329dy 18hr	659dy 12hr	989dy 6hr	1319dys

2CIF mode

Frame Rate	HDD 500Gb	HDD 1.0Tb	HDD 2.0Tb	HDD 3.0Tb	HDD 4.0Tb
25	5dy 3hr	10dy 7hr	20dy 14hr	30dy 21hr	41dy 4hr
12	10dy 7hr	20dy 14hr	41dy 5hr	61dy 19hr	82dy 10hr
6	20dy 14hr	41dy 5hr	82dy 10hr	123dy 15hr	164dy 20hr
4	27dy 11hr	54dy 23hr	109dy 22hr	164dy 21hr	219dy 20hr
2	54dy 23hr	109dy 22hr	219dy 20hr	329dy 18hr	439dy 16hr
1	82dy 10hr	164dy 21hr	329dy 18hr	494dy 15hr	659dy 12hr

4CIF mode

Frame Rate	HDD 500Gb	HDD 1.0Tb	HDD 2.0Tb	HDD 3.0Tb	HDD 4.0Tb
25	2dy 14hr	5dy 3hr	10dy 7hr	15dy 10hr	20dy 14hr
12	5dy 3hr	10dy 7hr	20dy 14hr	30dy 21hr	41dy 5hr
6	10dy 7hr	20dy 14hr	41dy 5hr	61dy 19hr	82dy 10hr
4	20dy 14hr	27dy 11hr	54dy 23hr	82dy 10hr	109dy 22hr
2	27dy 11hr	54dy 23hr	109dy 22hr	164dy 21hr	219dy 20hr
1	54dy 23hr	82dy 10hr	164dy 21hr	247dy 7hr	329dy 18hr

18.3 Record Timings for 4 channels - Alien654

CIF mode

Frame Rate	HDD 500Gb	HDD 1.0Tb	HDD 2.0Tb	HDD 3.0Tb	HDD 4.0Tb
25	20dy 14hr	41dy 5hr	82dy 10hr	123dy 15hr	164dy 20hr
12	41dy 5hr	82dy 10hr	164dy 20hr	247dy 6hr	329dy 16hr
6	82dy 10hr	164dy 21hr	329dy 18hr	494dy 15hr	659dy 8hr
4	109dy 22hr	219dy 20hr	439dy 17hr	659dy 13hr	879dy 10hr
2	219dy 20hr	439dy 17hr	879dy 10hr	1319dy 3hr	1758dy 20hr
1	439dy 17hr	879dy 10hr	1319dy 3hr	2198dy 13hr	2638dy 6hr

2CIF mode

Frame Rate	HDD 500Gb	HDD 1.0Tb	HDD 2.0Tb	HDD 3.0Tb	HDD 4.0Tb
25	10dy 7hr	20dy 14hr	41dy 5hr	61dy 19hr	82dy 10hr
12	20dy 14hr	41dy 5hr	82dy 10hr	123dy 15hr	164dy 21hr
6	41dy 5hr	82dy 10hr	164dy 21hr	247dy 7hr	329dy 18hr
4	54dy 23hr	109dy 22hr	219dy 20hr	329dy 18hr	439dy 17hr
2	109dy 22hr	219dy 20hr	439dy 17hr	659dy 13hr	879dy 10hr
1	219dy 20hr	439dy 17hr	879dy 10hr	1319dy 3hr	1758dy 20hr

4CIF mode

Frame Rate	HDD 500Gb	HDD 1.0Tb	HDD 2.0Tb	HDD 3.0Tb	HDD 4.0Tb
25	5dy 4hr	10dy 7hr	20dy 14hr	30dy 21hr	41dy 5hr
12	10dy 7hr	20dy 14hr	41dy 5hr	64dy 19hr	82dy 10hr
6	20dy 15hr	41dy 5hr	82dy 10hr	123dy 15hr	164dy 21hr
4	27dy 12hr	54dy 23hr	109dy 22hr	164dy 21hr	219dy 20hr
2	54dy 23hr	109dy 22hr	219dy 20hr	329dy 18hr	439dy 17hr
1	109dy 22hr	219dy 20hr	439dy 17hr	659dy 13hr	879dy 10hr

18.4 Record Timings for 16 channels - Alien916 HD Model

CIF mode

Frame Rate	HDD 1.0Tb	HDD 2.0Tb	HDD 3.0Tb	HDD 4.0Tb
25	10.33dy	20.65dy	30.98dy	41.31dy
12	20.65dy	41.30dy	61.96dy	82.61dy
6	41.30dy	82.61dy	123.91dy	165.22dy
4	55.07dy	110.15dy	165.22dy	220.29dy
2	110.21dy	220.42dy	330.64dy	440.85dy
1	165.22dy	330.44dy	495.66dy	660.87dy

2CIF mode

Frame Rate	HDD 1.0Tb	HDD 2.0Tb	HDD 3.0Tb	HDD 4.0Tb
25	5.16dy	10.33dy	15.49dy	20.65dy
12	10.33dy	20.65dy	30.98dy	41.31dy
6	20.65dy	41.30dy	61.96dy	82.61dy
4	27.54dy	55.07dy	82.61dy	110.15dy
2	55.07dy	110.15dy	165.22dy	220.29dy
1	82.61dy	165.22dy	247.83dy	330.44dy

4CIF mode

Frame Rate	HDD 1.0Tb	HDD 2.0Tb	HDD 3.0Tb	HDD 4.0Tb
25	2.58dy	5.16dy	7.75dy	10.33dy
12	5.16dy	10.33dy	15.49dy	20.65dy
6	10.33dy	20.65dy	30.98dy	41.31dy
4	13.77dy	27.54dy	41.30dy	55.07dy
2	27.54dy	55.07dy	82.61dy	110.15dy
1	41.30dy	82.61dy	123.91dy	165.22dy

720P mode

Frame Rate	HDD 1.0Tb	HDD 2.0Tb	HDD 3.0Tb	HDD 4.0Tb	HDD 8.0Tb	HDD 16.0Tb
25	1.29dy	2.58dy	3.87dy	5.16dy	10.33dy	20.65dy
12	2.58dy	5.16dy	7.75dy	10.33dy	20.65dy	41.31dy
6	5.16dy	10.33dy	15.49dy	20.65dy	41.31dy	82.61dy
4	6.88dy	13.77dy	20.65dy	34.42dy	55.08dy	110.15dy
2	13.77dy	27.54dy	41.30dy	55.07dy	110.15dy	220.29dy
1	20.65dy	41.30dy	61.96dy	82.61dy	165.22dy	330.44dy

1080P mode

Frame Rate	HDD 1.0Tb	HDD 2.0Tb	HDD 3.0Tb	HDD 4.0Tb	HDD 8.0Tb	HDD 16.0Tb
25	.52dy	1.03dy	1.55dy	2.07dy	4.13dy	8.26dy
12	1.03dy	2.07dy	3.10dy	4.13dy	8.26dy	16.52dy
6	2.07dy	4.13dy	6.20dy	8.26dy	16.52dy	33.05dy
4	2.75dy	5.51dy	8.26dy	11.02dy	22.03dy	44.06dy
2	5.51dy	11.02dy	16.52dy	22.04dy	44.06dy	88.12dy
1	8.26dy	16.52dy	24.79dy	33.06dy	66.09dy	132.19dy

18.5 Record Timings for 8 channels - Alien678 HD Model

CIF mode

Frame Rate	HDD 500Gb	HDD 1.0Tb	HDD 2.0Tb	HDD 3.0Tb	HDD 4.0Tb
25	10dy 7hr	20dy 14hr	41dy 4hr	61dy 18hr	82dy 8hr
12	20dy 14hr	41dy 5hr	82dy 10hr	123dy 15hr	164dy 20hr
6	41dy 5hr	82dy 10hr	164dy 20hr	247dy 6hr	329dy 16hr
4	54dy 23hr	109dy 22hr	219dy 20hr	329dy 20hr	439dy 16hr
2	109dy 22hr	219dy 20hr	439dy 16hr	659dy 12hr	879dy 8hr
1	164dy 21hr	329dy 18hr	659dy 12hr	989dy 6hr	1319dys

2CIF mode

Frame Rate	HDD 500Gb	HDD 1.0Tb	HDD 2.0Tb	HDD 3.0Tb	HDD 4.0Tb
25	5dy 3hr	10dy 7hr	20dy 14hr	30dy 21hr	41dy 4hr
12	10dy 7hr	20dy 14hr	41dy 5hr	61dy 19hr	82dy 10hr
6	20dy 14hr	41dy 5hr	82dy 10hr	123dy 15hr	164dy 20hr
4	27dy 11hr	54dy 23hr	109dy 22hr	164dy 21hr	219dy 20hr
2	54dy 23hr	109dy 22hr	219dy 20hr	329dy 18hr	439dy 16hr
1	82dy 10hr	164dy 21hr	329dy 18hr	494dy 15hr	659dy 12hr

4CIF mode

Frame Rate	HDD 500Gb	HDD 1.0Tb	HDD 2.0Tb	HDD 3.0Tb	HDD 4.0Tb
25	2dy 14hr	5dy 3hr	10dy 7hr	15dy 10hr	20dy 14hr
12	5dy 3hr	10dy 7hr	20dy 14hr	30dy 21hr	41dy 5hr
6	10dy 7hr	20dy 14hr	41dy 5hr	61dy 19hr	82dy 10hr
4	20dy 14hr	27dy 11hr	54dy 23hr	82dy 10hr	109dy 22hr
2	27dy 11hr	54dy 23hr	109dy 22hr	164dy 21hr	219dy 20hr
1	54dy 23hr	82dy 10hr	164dy 21hr	247dy 7hr	329dy 18hr

720P mode

Frame Rate	HDD 500Gb	HDD 1.0Tb	HDD 2.0Tb	HDD 3.0Tb	HDD 4.0Tb
25	1dy 7hr	2dy 14hr	5dy 4hr	7dy 18hr	10dy 8hr
12	2dy 14hr	5dy 4hr	10dy 8hr	15dy 12hr	20dy 16hr
6	5dy 4hr	10dy 8hr	20dy 16hr	30dy 23hr	41hr 8hr
4	6dy 21hr	13dy 18hr	27dy 13hr	41dy 7hr	55dy 2hr
2	13dy 18hr	27dy 13hr	55dy 2hr	82dy 15hr	110dy 4hr
1	20dy 16hr	41dy 7hr	82dy 15hr	123dy 21hr	165dy 5hr

1080P mode

Frame Rate	HDD 500Gb	HDD 1.0Tb	HDD 2.0Tb	HDD 3.0Tb	HDD 4.0Tb
12	1dy	2dy 2hr	4dy 3hr	6dy 5hr	8dy 6hr
6	2dy 2hr	4dy 3hr	8dy 6hr	12dy 9hr	16dy 12hr
4	2dy 18hr	5dy 12hr	11dy	16dy 12hr	22dy
2	5dy 12hr	11dy	22dy	33dy 1hr	44dy 1hr
1	8dy 6hr	16dy 12hr	33dy 1hr	49dy 14hr	66dy 2hr

18.6 Record Timings for 4 channels - Alien674 (HD Models)

CIF mode

Frame Rate	HDD 500Gb	HDD 1.0Tb	HDD 2.0Tb	HDD 3.0Tb	HDD 4.0Tb
25	20dy 14hr	41dy 5hr	82dy 10hr	123dy 15hr	164dy 20hr
12	41dy 5hr	82dy 10hr	164dy 20hr	247dy 6hr	329dy 16hr
6	82dy 10hr	164dy 21hr	329dy 18hr	494dy 15hr	659dy 8hr
4	109dy 22hr	219dy 20hr	439dy 17hr	659dy 13hr	879dy 10hr
2	219dy 20hr	439dy 17hr	879dy 10hr	1319dy 3hr	1758dy 20hr
1	439dy 17hr	879dy 10hr	1319dy 3hr	2198dy 13hr	2638dy 6hr

2CIF mode

Frame Rate	HDD 500Gb	HDD 1.0Tb	HDD 2.0Tb	HDD 3.0Tb	HDD 4.0Tb
25	10dy 7hr	20dy 14hr	41dy 5hr	61dy 19hr	82dy 10hr
12	20dy 14hr	41dy 5hr	82dy 10hr	123dy 15hr	164dy 21hr
6	41dy 5hr	82dy 10hr	164dy 21hr	247dy 7hr	329dy 18hr
4	54dy 23hr	109dy 22hr	219dy 20hr	329dy 18hr	439dy 17hr
2	109dy 22hr	219dy 20hr	439dy 17hr	659dy 13hr	879dy 10hr
1	219dy 20hr	439dy 17hr	879dy 10hr	1319dy 3hr	1758dy 20hr

4CIF mode

Frame Rate	HDD 500Gb	HDD 1.0Tb	HDD 2.0Tb	HDD 3.0Tb	HDD 4.0Tb
25	5dy 4hr	10dy 7hr	20dy 14hr	30dy 21hr	41dy 5hr
12	10dy 7hr	20dy 14hr	41dy 5hr	64dy 19hr	82dy 10hr
6	20dy 15hr	41dy 5hr	82dy 10hr	123dy 15hr	164dy 21hr
4	27dy 12hr	54dy 23hr	109dy 22hr	164dy 21hr	219dy 20hr
2	54dy 23hr	109dy 22hr	219dy 20hr	329dy 18hr	439dy 17hr
1	109dy 22hr	219dy 20hr	439dy 17hr	659dy 13hr	879dy 10hr

720P mode

Frame Rate	HDD 500Gb	HDD 1.0Tb	HDD 2.0Tb	HDD 3.0Tb	HDD 4.0Tb
25	2dy 14hr	5dy 4hr	10dy 8hr	15dy 12hr	20dy 16hr
12	5dy 4hr	10dy 8hr	20dy 16hr	31dy	41dy 7hr
6	10dy 8hr	20dy 16hr	41dy 7hr	61dy 23hr	82dy 15hr
4	13dy 18hr	27dy 13hr	55dy 2hr	82dy 15hr	110dy 4hr
2	27dy 13hr	55dy 2hr	110dy 4hr	165dy 5hr	220dy 7hr
1	41dy 7hr	82dy 15hr	165dy 5hr	247dy 20hr	330dy 11hr

1080P mode

Frame Rate	HDD 500Gb	HDD 1.0Tb	HDD 2.0Tb	HDD 3.0Tb	HDD 4.0Tb
12	2dy 2hr	4dy 3hr	8dy 6hr	12dy 9hr	16dy 12hr
6	4dy 3hr	8dy 6hr	16dy 12hr	24dy 19hr	33dy 1hr
4	5dy 12hr	11dy	22dy	33dy 1hr	44dy 1 hr
2	11dy	22dy	44dy 1hr	66dy 2hr	88dy 3hr
1	16dy 12hr	33dy	66dy 2hr	99dy 3hr	132dy 4hr

19. Frame Rate Settings for Alien916

Frame Rate Setting	Frame Rate
MAINSTREAM CIF	25
MAINSTREAM 2CIF	25
MAINSTREAM 4CIF	25
MAINSTREAM 1080P	25
SUBSTREAM QCIF	YES
SUBSTREAM MAX FRAMES	25
SUBSTREAM CIF	YES
SUBSTREAM MAX FRAMES	25

20. Technical Data Sheet

Model	ALIEN666	ALIEN658/678	ALIEN654/674
Video Compression	H264		
Video Input	16 channels BNC	8 channels BNC	4 channels BNC
Picture Format	PAL / NTSC		
Video Output HDMI	1 x HDMI or VGA		
Video Output CBVS	(BNC) x 1 (Excluding Alien674 and Alien678)		
Video Bit Rate	32Kbps ~ 2048Kbps		
Audio Compression	OggVorbis		
Audio Inputs	1 x Phono (2.0v p~p)		
Audio Outputs	1 x Phono (2.0v p~p, 1K Ω)		
Audio Bitrate	16Kbps		
Recording Resolution	4CIF, 2CIF, CIF, QCIF		
Frame Rate	Max. 25 fps in PAL		
Dual Stream	Mainstream/Substream		
Synchronous Playback	16 channels	8 channels	4 channels
SATA Interfaces	2 x SATA Hard Drive		1 x SATA Hard Drive
Hard Drive Capacity	8Tb		4Tb
Network Interfaces	RJ45 10M/100M		
USB Interface	2 x USB2 Interfaces		
Serial Interfaces	1 x RS485, 1 x RS232		
Alarm Inputs	16 x channels	8 channels	4 channels
Alarm Outputs	16 x channels	8 channels	4 channels
Power Supply	12vDC 5A	12vDC 3.3A	12vDC 2A
Power Consumption	0.7A 12vDC	0.6A 12vDC	0.41A 12vDC
Working Temperature	-10°C ~ +55°C		
Working Humidity	10% ~ 90%		
Dimensions	440(w) x 296(D) x 54(H)mm	440(w) x 296(D) x 54(H)mm	320(W) x 230(D) x 50(H)mm
Weight	7Kg	6Kg	4Kg

Model	ALIEN916	
Video Compression	H264	
Video Input	16 channels HD-SDI	
Picture Format	PAL	
Video Output HDMI	1 x HDMI / VGA	
Video Output CBVS	(BNC) x 1	
Video Bit Rate	32Kbps ~ 2048Kbps	
Audio Compression	OggVorbis	
Audio Inputs	16 x Phono (2.0v p~p)	
Audio Outputs	2x Phono (2.0v p~p, 1K Ω)	
Audio Bitrate	16Kbps	
Recording Resolution	1080P, 720P, 4CIF, 2CIF, CIF, QCIF	
Frame Rate	Max. 25 fps in PAL	
Dual Stream	Mainstream/Substream	
Synchronous Playback	16 channels	
SATA Interfaces	4 x SATA Hard Drive + DVD Writer	8 x SATA Hard Drive without Writer
Hard Drive Capacity	4Tb	
Network Interfaces	2 x RJ45 10M/100M Network Cards	
USB Interface	3 x USB2 Interfaces	
Serial Interfaces	1 x RS485, 1 x RS232	
Alarm Inputs	16 x channels	
Alarm Outputs	4 x channels	
Power Supply	240v AC	
Rack Mount Spec	2U 19" Rack Mount	
Working Temperature	-10°C ~ +55°C	
Working Humidity	10% ~ 90%	
Dimensions	450(w) x 470(D) x 95(H)mm	
Weight	7Kg	