

ZENDit™

www.zendit.co

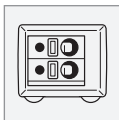
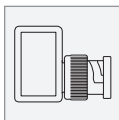
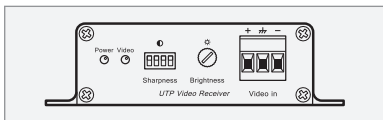
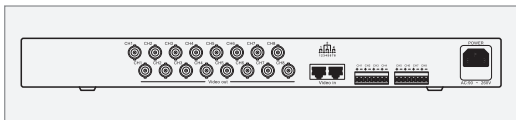
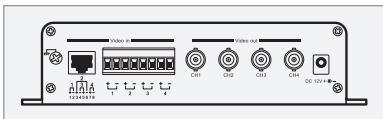

Quality passive and active video baluns for long distance transmission of CCTV images

ZEN-BAL-V1

Introduction

Our Zendit range of passive and active video baluns offers superb quality and great value.

We have a wide variety of baluns available to suit any install, from mini 1ch baluns to 16ch rack mount baluns.

As well as standard baluns we offer baluns with clever additional features making installation even easier, such as RJ45 sockets, baluns which lock together for a neat installation and baluns which combine video, power and data.

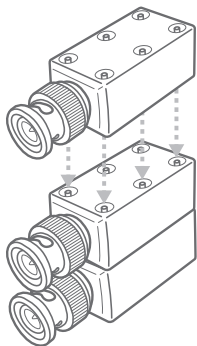

Contents

What Are Video Baluns?	4
What's Inside A Balun?	5
The Advantages Of Using CAT5	6
How CAT5 Transmission Works	7
Using Video Baluns	8
Connecting Video Baluns	10
Connecting With An RJ45 Cable	11
Connecting With Twisted Pairs	12
Connecting With BNC Plugs	13
Pairing Video Baluns	14
Passive Video Baluns Models	16
Active Video Baluns Models	42
Fault Finding	60
Other Products In The Zendit Range	61
Other Products To Consider	62

What Are Video Baluns?

Video baluns allow transmission of real-time standard composite video over Unshielded Twisted Pair (UTP) CAT5.

A balun is required at both ends of the cable run. The CAT5 can be connected via an RJ45 connector or via the appropriate connection on the terminal block. At the Rx end, the output is usually via a BNC connector.

Co-axial cables are classed as an “**unbalanced**” mode of transmission and CAT5 twisted pair is known as a “**balanced**” mode. In this balanced mode, the two cores carrying the video signal are balanced to a particular reference point and the cable twists enable a uniform rejection of interference, effectively cancelling it out. To produce an unbalanced signal **BALUNS** are used, standing for **BAL**anced to **UN**balanced.

Baluns come in two distinct groups. **Passive** baluns require no power to operate and work up to distances of about 500m although if you are using baluns to send video signals back to switchers, quads and DVRs it is recommended not to use passive baluns over 200m.

What Are Video Baluns?

Active baluns require power for their “active” circuitry and can send video signals up to 2km down low-cost CAT5 cable. Most baluns (unless stated) do not allow you to send power down the CAT5 cable so **you will still need to power the camera** locally or run another separate cable for power.

What's Inside A Balun?

Baluns contain small signal transformers that are specially tuned to match the cables impedance and convert the unbalanced signal to a balanced one and vice versa. Passive baluns just have the transformers and very little else in them. Active baluns have extra electronic circuits used to amplify the signals helping prevent losses and also filtering out unwanted noise.

The Advantage Of Using CAT5

CAT5 cable is a tremendously flexible way to install and distribute CCTV signals around buildings and between locations. If, for example, you have two buildings 200mtrs apart you could use one CAT5 cable to run 4 CCTV images from one building to another by using two video baluns. This provides savings on both labour and cable costs.

Often you can find a spare CAT5 cable that is not being used which was put in originally as a spare data cable. CAT5 cable is also easy to handle and quite low cost. New commercial buildings are often “flooded” with CAT5 cabling, allowing great scope to alter where and how CCTV cameras are used without necessarily having to install new and additional cables.

Computer installation engineers use what are called “**patch panels**” and these can also be used with great success for CCTV installations. In this structured cabling system

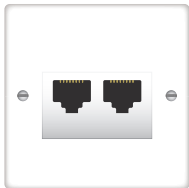

The Advantage Of Using CAT5

you have to work out where CCTV equipment may be needed and install the appropriate CAT5 outlets nearby. It is also wise to provide some local source (or potential source) of power. By bringing all the CAT5s to one area and installing what is called a “patch panel” you can then re-distribute the signals however you please.

How CAT5 Transmission Works

When the video signal enters the balun at the camera end it is split into two, half the signal is sent down one core of the twisted pair and half is inverted and sent down the second core. In a twisted pair both wires are equally exposed to electromagnetic interference (EMI). Consequentially any interference affects both cores equally. When the signals enter the balun at the DVR end, the signal in one core is inverted and added to the other core there by recovering the original signal causing the extra noise to be cancelled. Spikes which appeared in both signals effectively cancel each other out and are removed. This is called common mode rejection.

Using Video Baluns

Baluns requires a pair of cores in the CAT5 cable for each video signal, and there will need to be a balun at each end of the CAT5 cable. One balun converts the unbalanced signal to balanced for communication across the CAT5 balanced twisted pair and the second balun converts the balanced signal back to an unbalanced signal. Baluns cannot send video through “hubs” or computer “switches” as they work in a purely analogue method rather than the digital “packet” method of hubs or switches. This means that you cannot use baluns to send video pictures through existing computer networks that use switches or hubs.

Step 1 Run in your CAT5 cable. This needs to be run between your camera and the rest of your CCTV equipment. One CAT5 cable with 4 pairs can theoretically carry 4 video signals, one per each pair of cores. It is good practice to run in more cable than you actually need as this gives flexibility to add extra cameras, audio feeds etc.

Step 2 Identify the various pairs within the CAT5 cable. CAT5 has 4 easy to identify colour coded pairs.

Using Video Baluns

Step 3 Connect the SAME pair of cores to both baluns using the terminal connections or RJ45. Always adopt the same standard using the SOLID colour core as “-” and the striped core as “+” when connecting to the balun terminals. It does not matter which pair of cores you choose to use but they must be a pair and you must get the polarity of the cores correct at the baluns (See diagram on page 12).

Step 4 Use a BNC–BNC lead to connect the transmitter balun to each camera. Similarly use another BNC-BNC lead to connect the receiver balun to the monitor or DVR etc.

TIP

You may get a good picture when connecting directly into a monitor but a poor or bright picture when connecting into a DVR or a quad. This is because monitors are very “forgiving” with the level and quality of the video signal supplied to it. Quads, Switchers and DVRs are far less forgiving and require a near perfect video signal to give good results.

Connecting Video Baluns

CAT5 cable can be connected to video baluns in three ways. The two most common are RJ45 sockets and terminal connections. However, some baluns such as our BAL250s have BNC connections.

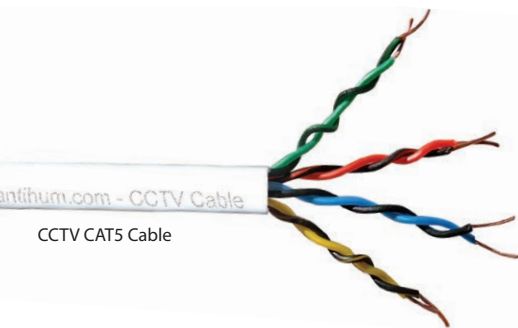

CCTV CAT5 Cable



RJ45 Straight (Patch) Cable

Connecting With An RJ45 Cable

The easiest way to connect baluns which have RJ45 sockets is with an RJ45 'Straight' cable.
(Note - Never use RJ45 'Crossover' cables with video baluns).



If you prefer to use a CAT5 cable with an RJ45 Plug the pairs must be connected to the pins as shown below.

CCTV CAT5

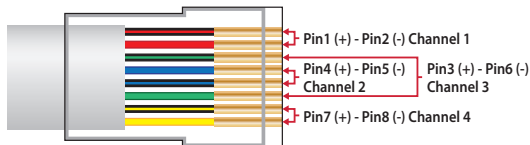

Standard CAT5

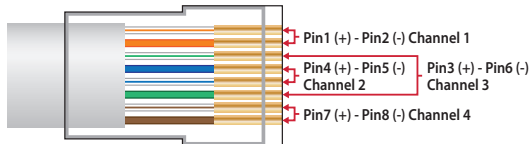

Connecting With Twisted Pairs

When connecting baluns with terminal connections using CAT5 you should use **one twisted pair per channel**. The terminals are polarity sensitive so each wire must be connected to the corresponding poles on both baluns.

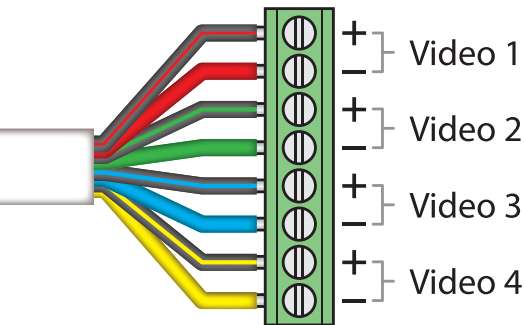

TIP

The exact order in which cores are connected to the terminal block must be replicated at both ends of the CAT5 cable run.

Connecting With BNC Plugs

For baluns with BNC connections we recommend you use a **CON380** terminal strip to BNC connector. The terminal connections on **CON380s** are **polarity sensitive** so wires must be connected to the corresponding poles on the paired balun.

BNC Plug Connection Example

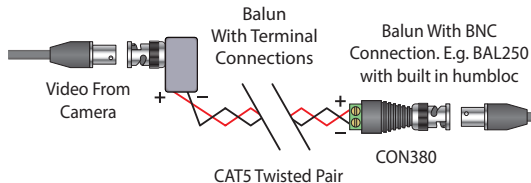

CON380 - Terminal Strip To BNC Connector



Pairing Video Baluns

When pairing video baluns you have **3 options** depending on the transmission distance you wish to achieve.

Your first option is to simply use two passive baluns which allows you to transmit video up to 200m down CAT5 (depending on the balun), without significant image degradation.

For cable runs up to 1000m you can pair a passive balun with an active balun receiver or transmitter. This allows you to achieve longer cable runs without having to find a power source for two active baluns.

For cable runs over 1000m you would need to pair an active balun transmitter with an active balun receiver. This would allow you to send video up to 2000m down CAT5.

Your 3 Options When Pairing Video Baluns

Passive ◀ ▶ Passive - Up To 200m

Passive ◀ ▶ Active - 100m To 1000m

Active ◀ ▶ Active - 1000m To 2000m

Pairing Video Baluns

1. Passive To Passive



No power required at either balun

2. Passive To Active

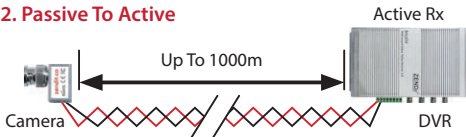

Power required for active balun only

3. Active Transmitter To Active Receiver

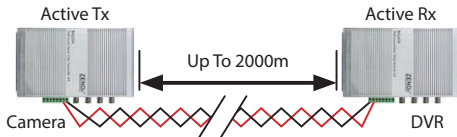

Power required at both baluns

Passive Video Baluns

Passive baluns allow you to transmit multiple video signals up to 200m down a single CAT5 cable with minimum image degradation. The advantage to using passive baluns is that they don't require power so additional cabling or power sources are not needed. You can also pair passive baluns with active baluns to transmit video signals up to 1000m over CAT5. For more information see **pages 14 & 15**.

Passive Balun Contents

Pairing Multiple Baluns	17
BAL102 - Mini 1ch Passive	18
BAL250 - 1ch Passive With Ground Loop Isolator	20
BAL106 - 1ch In-line Passive	22
BAL206 - 1ch Pigtail Passive	24
BAL215 - 1ch Pigtail Passive, Video, Power & Data	26
BAL304 - 4ch Wall-mount Passive	30
BAL308 - 8ch Wall-mount Passive	34
BAL316 - 16ch Rack-mount Passive	38

Pairing Multiple Baluns

Our wide range of baluns offer maximum flexibility when transmitting video over CAT5. Different size baluns can be paired together so the exact configuration may differ from job to job. The number and size of baluns used is usually dictated by the distance between the cameras. For example, on a smaller install four 1ch baluns may be paired with a single 4ch balun at the DVR end. On larger installs four 1ch baluns, a 4ch balun and an 8ch balun may all be paired with a 16ch balun at the DVR end.

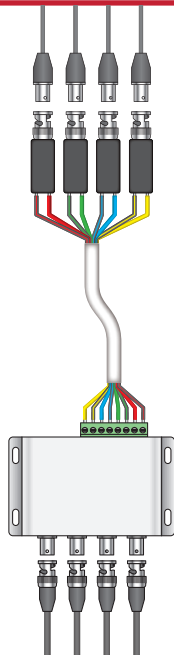

BAL102 - Mini Passive Balun (pair)



BAL102 Features

- Tiny size, fits side by side on a DVR's inputs
- Great for fitting inside a traditional camera housing
- BNC plugs for easy connection
- Screw terminals for connecting CAT5

FUNCTION	SPECIFICATION
Maximum Distance	100m
Power / Current	Passive - No Power Required
Dimensions	31.5 x 25 x 15.5mm

BAL102 - Features

The BAL102s feature screw terminals for connecting one twisted pair from a CAT5 cable. The terminals are polarity sensitive and are clearly marked "+" and "-". Each core must be connected to the corresponding terminal on both baluns. For more information see page 12.



BAL102 Connection Example

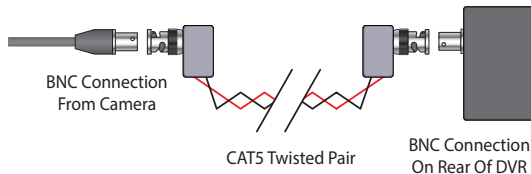

BAL250 - Balun & Ground Loop Isolator



Removes Rolling Humbars

BAL250 Features

- Pairs with BAL102, BAL106 and BAL206
- 2 In 1 design - Balun and ground loop isolator
- BNC plugs for easy connection
- Removes rolling humbars and image tearing

FUNCTION	SPECIFICATION
Maximum Distance	100m
Power / Current	Passive - No Power Required
Dimensions	56 x 28 x 21mm (240mm BNC Leads)

BAL250 - Features

The BAL250 has a built-in "Ground Loop" isolator. This enables it to remove "humbars" caused by multiple grounds as well as reducing interference. To use the BAL250 on a CAT5 installation **requires a CON380** terminal strip to BNC connector. The BAL250 can then be paired with any 1ch passive balun which has terminal connections. For more information on connecting baluns using a CON380 connector see page 13.

NOTE The BAL250 must be used at the DVR end!

BAL250 Connection Example

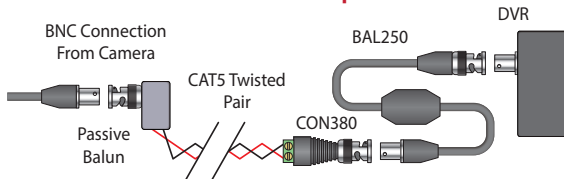

TIP

159

Find out more about the causes of humbars in our downloadable **TIP159** at zendit.co

BAL106 - In-line Passive Balun (pair)

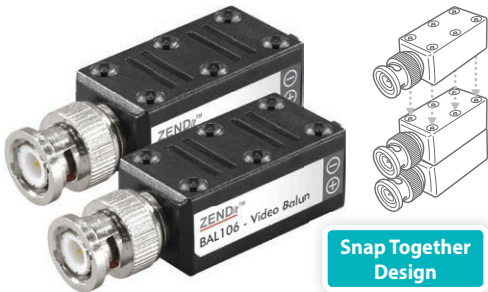

Snap Together Design

BAL106 Features

- Unique snap together design for neat installation
- Compact size
- Spring terminals for connecting CAT5

FUNCTION	SPECIFICATION
Maximum Distance	100m
Power / Current	Passive - No Power Required
Dimensions	59.5 x 20 x 17.5mm

BAL106 - Features

There are two polarity sensitive spring terminals for connecting CAT5 on the rear of the BAL106s. For more information on connecting baluns using CAT5 twisted pairs see page 12.

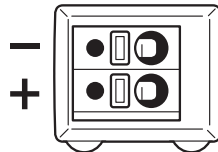

The BAL106s also feature a unique snap together design. The baluns can be clipped together to form one block for a neat and tidy installation.

BAL106 Connection Example

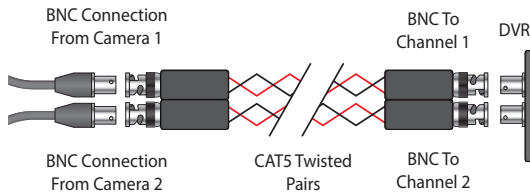

Unique Snap Together Design

BAL206 - Pigtail Passive Balun (pair)



Snap Together Design

BAL206 Features

- Unique snap together design for neat installation
- Pigtail design for added flexibility
- Spring terminals for connecting CAT5

FUNCTION	SPECIFICATION
Maximum Distance	100m
Power / Current	Passive - No Power Required
Dimensions	42.5 x 20 x 17.5mm (142.5mm Cable)

BAL206 - Features

There are two polarity sensitive spring terminals for connecting CAT5 on the rear of the BAL206s. For more information on connecting baluns using CAT5 twisted pairs see page 12.

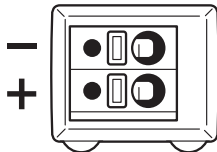

The BAL206s also feature a unique snap together design. The baluns can be clipped together to form one block for a neat and tidy installation.

BAL206 Connection Example

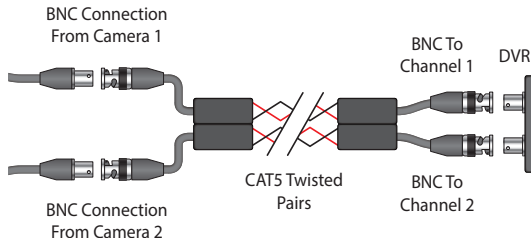

BAL215 - Passive Balun + Power & Data



Video,
Power &
Data/Audio

BAL215 Features

- Send video, power & data/audio down CAT5
- Works as normal balun without power & data
- RJ45 socket for connecting CAT5
- 2.1mm DC plug & socket fly-leads included

FUNCTION	SPECIFICATION
Maximum Distance	100m
Power / Current	Passive - No Power Required
Dimensions	62 x 28 x 21mm (140mm Cable)

BAL215 - Features



The BAL215s have **polarity sensitive spring terminals** for connecting power and data.

The data terminals can be used for either RS485 data, such as PTZ commands, or audio from a microphone or to a loudspeaker.

2.1mm DC Plug & Socket Fly-leads



To make connecting the power as easy as possible the BAL215s are supplied with both 2.1mm DC plug and sockets fly-lead.

See overleaf 

BAL215 - Connection Example

Below is an example of how the BAL215 is typically installed. In this example the data channel is used to send RS485 commands to the camera. **Alternatively the data channel can be used to carry audio** from a microphone to the DVR, or audio from the DVR to a loudspeaker next to the camera.

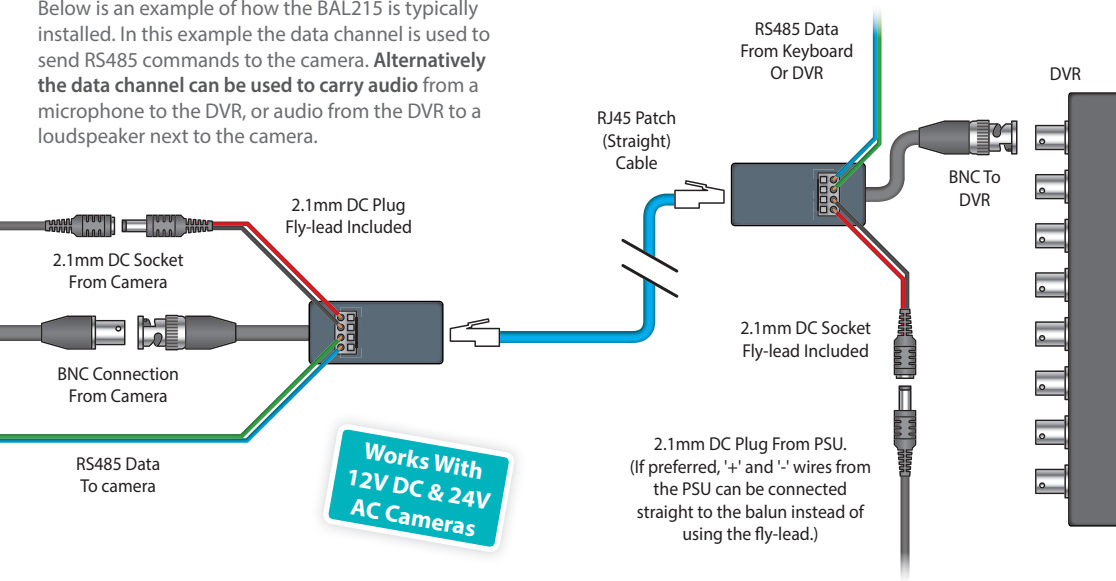

BAL304 - 4ch Passive Balun



Wall mount

BAL304 Features

- Terminal strip or RJ45 socket for connecting CAT5
- Compact design
- Wall or desk-mount for a tidy installation

FUNCTION	SPECIFICATION
Maximum Distance	200m
Power / Current	Passive - No Power Required
Dimensions	104 x 80 x 28mm

BAL304 - Features

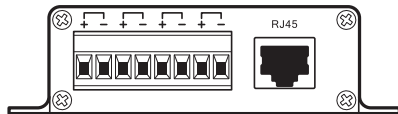

For extra flexibility the BAL304 features screw terminals along with an RJ45 socket. This allows the installer to use their preferred method of connection when using the balun.

For precise wiring and connection of CAT5 cables, please see our diagrams on **pages 11-12**.

Compact Design

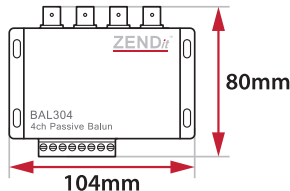

The BAL304's compact size makes it easy to install. Measuring 104 x 80mm and just 28mm deep!

Typical setup overleaf ▲

BAL304 - Connection Example

The BAL304 can send 4 video signals up to 200m over CAT5. For a simple installation you could install a 4ch balun at either end of the CAT5 run as shown below.

Alternatively you could use four 1ch baluns at the camera end of the installation for extra flexibility. This could still be achieved with one CAT5 cable with one of the four twisted pairs going to each balun.

For a quick and easy installation why not use an RJ45 straight (patch) cable.



Order Code: NET987 - 15m Straight Cable

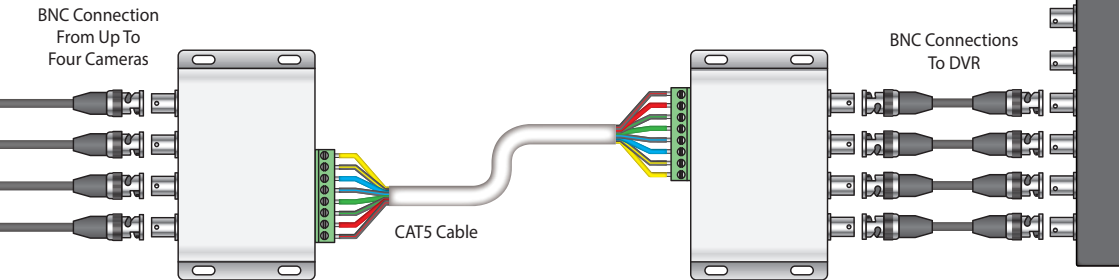

BAL308 - 8ch Passive Balun



Wall mount

BAL308 Features

- Terminal strip or RJ45 sockets for connecting CAT5
- Compact design
- Wall or desk-mount for a tidy installation

FUNCTION	SPECIFICATION
Maximum Distance	200m
Power / Current	Passive - No Power Required
Dimensions	157 x 90 x 28mm

BAL308 - Features

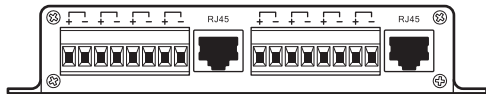

For extra flexibility the BAL308 features screw terminals along with two RJ45 sockets. This allows the installer to use their preferred method of connection when installing the balun.

For precise wiring and connection of CAT5 cables, please see our diagrams on **pages 11-12**.

Compact Design

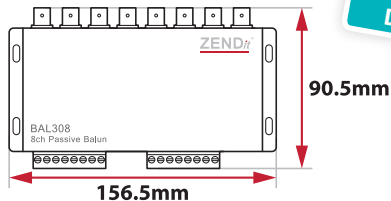

Typical setup overleaf ▲

BAL308 - Connection Example

The BAL308 allows you to send eight video channels up to 200m over CAT5. If your cameras are far apart it may not be practical to use an 8ch balun at the camera end of the installation. In this case you could **use a combination of 1 and 4ch baluns** and then feed them back to a single 8ch balun at the DVR end of the cable run.

For a quick and easy installation why not use an RJ45 straight (patch) cable.



Order Code: NET987 - 15m Straight Cable

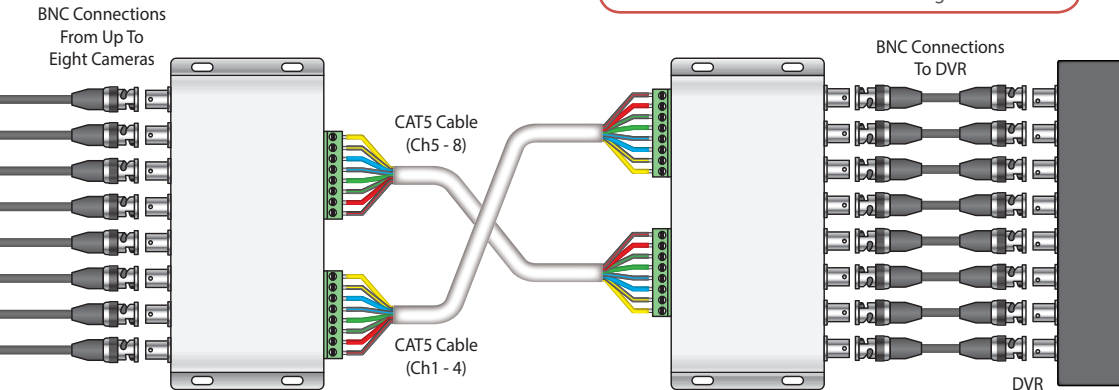

BAL316 - 16ch Passive Balun



Rack-mount

BAL316 Features

- Terminal strip or RJ45 sockets for connecting CAT5
- 1U 19" Rack-mount design (Brackets included)
- Use as a desktop unit with brackets removed

FUNCTION	SPECIFICATION
Maximum Distance	200m
Power / Current	Passive - No Power Required
Dimensions	430 x 180 x 44mm

BAL316 - Features & Mounting



The BAL316 has sixteen BNC sockets for connecting video from cameras or to a DVR. For connecting CAT5 there are four RJ45 sockets (4ch per socket) or alternatively four terminal blocks (4ch per block).

Rack-mounting The BAL316

If needed the BAL316 can be rack-mounted using the two small metal brackets supplied.



Remove Front 2 Screws

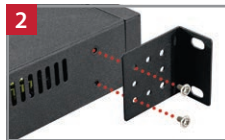

Screw Through Bracket



Do Same On Both Sides

BAL316 - Connection Example

The BAL316 is ideal when installing a large number of cameras. In most cases the cameras will be spaced out around the building. Installing a BAL316 at the DVR end of the cable run enables you to **use any combination of 1, 4 and 8ch baluns** at the camera end.

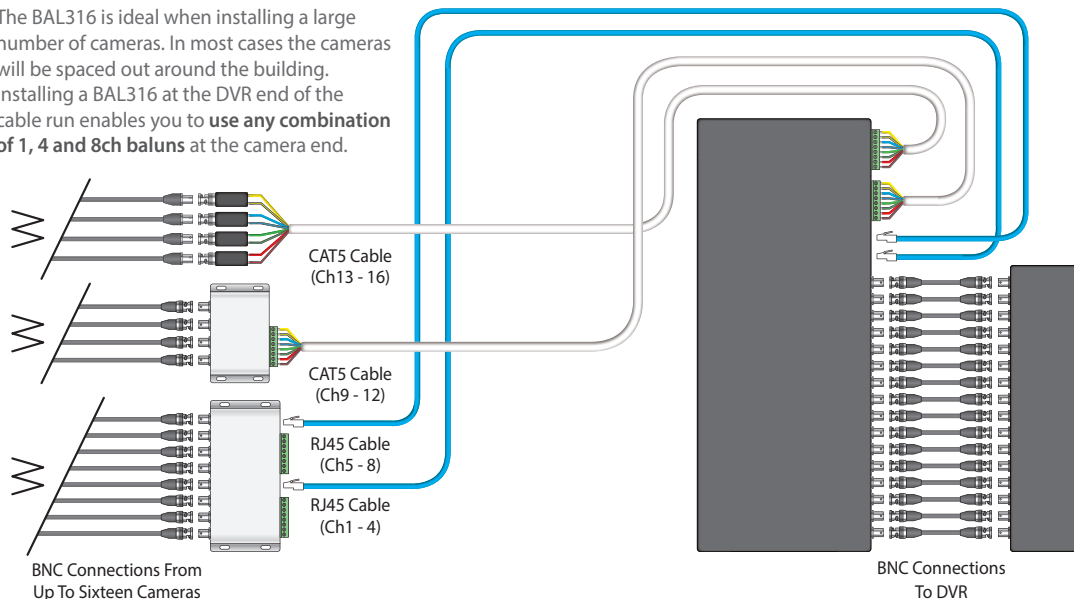

Active Video Baluns

Active baluns allow you to transmit images over far greater distances compared to passive baluns. With active baluns you can transmit video signals up to 2000m down CAT5 cable. You can also pair active baluns with passive baluns for runs up to 1000m. For more information on pairing video baluns and achievable distances please see **pages 14 & 15**.

Active Balun Contents

Active Receiver Controls	43
Active Transmitter Controls	44
Rack-mounting	45
Active Balun Connection Example	46
BAL601 - 1ch Active Receiver	48
BAL651 - 1ch Active Transmitter	50
BAL604 - 4ch Active Receiver	52
BAL654 - 4ch Active Transmitter	54
BAL658 - 8ch Rack-mount Active Receiver	56
BAL666 - 16ch Rack-mount Active Receiver	58

Active Receiver Controls

The **brightness** is simply controlled by the dials on the side of the unit (Shown right). Twisting the dial left and right will turn the brightness up and down for the respected channel.



The **sharpness** is controlled by a series of 4 dip switches which work on a binary system. The longer the cable run the higher the sharpness level will need to be set at. Level 0 is used for very short runs progressing up to level 15 which is used for 2000m runs. (See examples below)

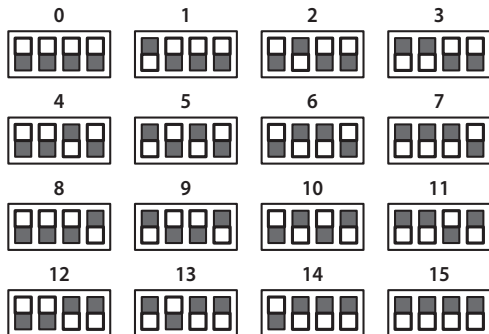

Active Transmitter Controls

The **Level** (range) for each channel is set with the slider on the side of the unit. The slider has 3 possible positions. The first position is for distances up to 1000m, the second position is used for distances up to 1500m and the final positions is for distances of up to 2000m as shown below.

Up To 1000m
(full left)



Up To 1500m
(middle)



Up To 2000m
(full right)



TIP

The settings stated are only to be used as a guide. If you encounter any display issues changing the position of the Level slider may help.

Rack-mounting

The BAL658 & BAL666 can be used as desktop units or rack-mounted if required. To prepare the unit for rack-mounting simply follow these 3 quick steps using the brackets supplied.



Remove the front 2 screws on either side of the unit.



Using the screws from step 1. Screw through the bracket and back into the original holes.



After doing the same on both sides the unit is ready to be mounted.

Active Balun Connection Example

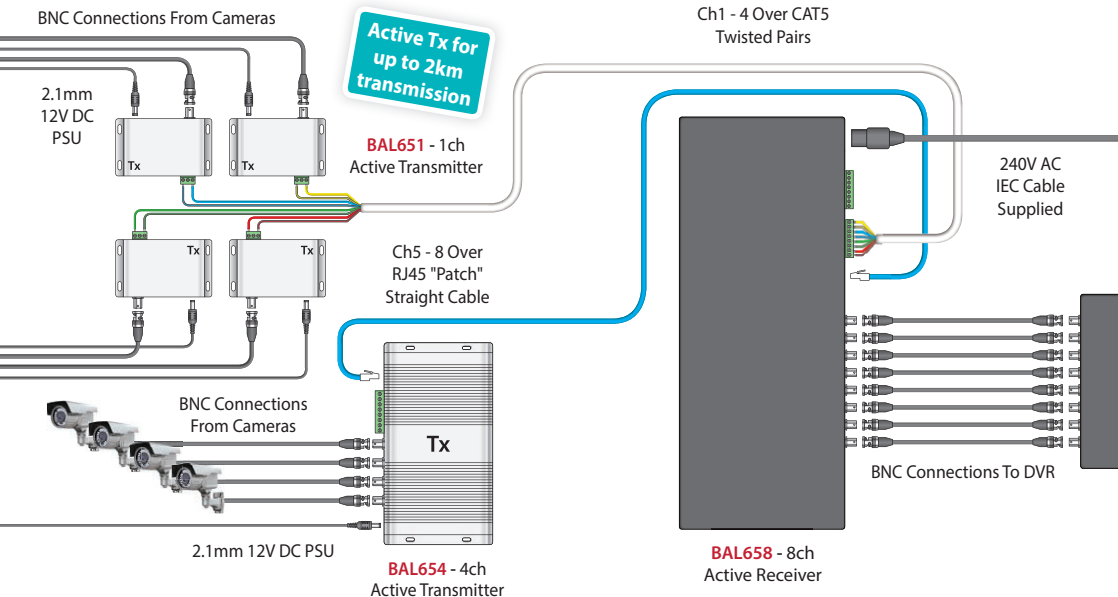



Up to 2km transmission

BAL601 Features

- Terminal strip for connecting CAT5
- Brightness & sharpness controls
- Wall or desk-mount for a tidy installation

FUNCTION	SPECIFICATION
Maximum Distance	2000m (With Active Transmitter)
Power / Current	12V DC / 50mA (PSU Required)
Dimensions	104 x 80 x 28mm

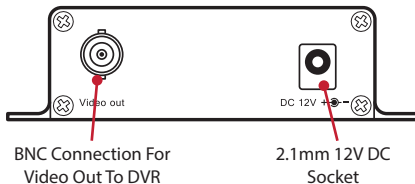
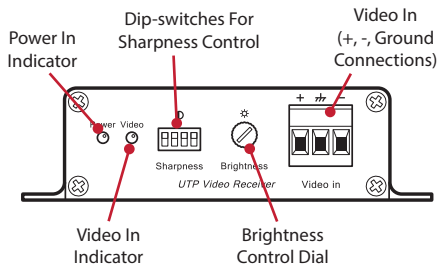

Pairs with Active transmitter

See page 43 for active receiver controls



Up to 2km
transmission

BAL651 Features

- Terminal strip for connecting CAT5
- Transmission range control
- Wall or desk-mount for a tidy installation

FUNCTION	SPECIFICATION
Maximum Distance	2000m
Power / Current	12V DC / 45mA (PSU Required)
Dimensions	104 x 80 x 28mm

BNC Connection For
Video In From Camera

2.1mm 12V DC
Socket



Power In
Indicator

Video Out
(+, -, Ground
Connections)

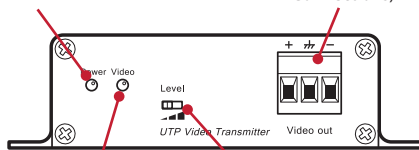

Video In
Indicator

Transmission Range
Control Slider

Pairs with Active receiver

See page 44 for active transmitter controls

BAL604 - 4ch Active Receiver



Up to 2km transmission

BAL604 Features

- Terminal strip or RJ45 sockets for connecting CAT5
- Brightness & sharpness controls
- Wall or desk-mount for a tidy installation

FUNCTION	SPECIFICATION
Maximum Distance	2000m (With Active Transmitter)
Power / Current	12V DC / 150mA (PSU Required)
Dimensions	203 x 119 x 48mm

BAL604 - Features

DVR End

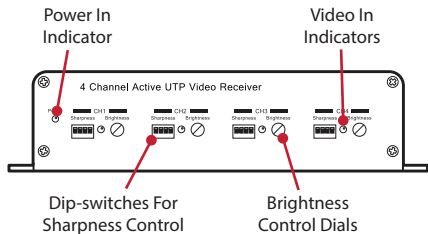
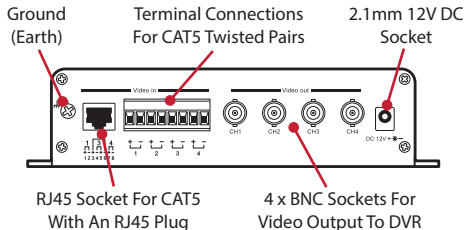

Pairs with Active transmitter

See page 43 for active receiver controls

BAL654 - 4ch Active Transmitter



Up to 2km
transmission

BAL654 Features

- Terminal strip or RJ45 sockets for connecting CAT5
- Transmission range control
- Wall or desk-mount for a tidy installation

FUNCTION	SPECIFICATION
Maximum Distance	2000m
Power / Current	12V DC / 150mA (PSU Required)
Dimensions	203 x 117 x 48mm

BAL654 - Features

Camera End

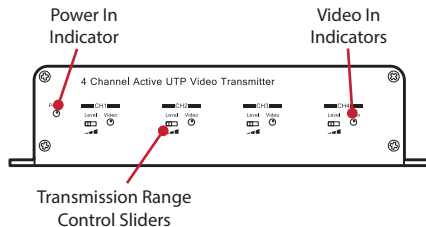
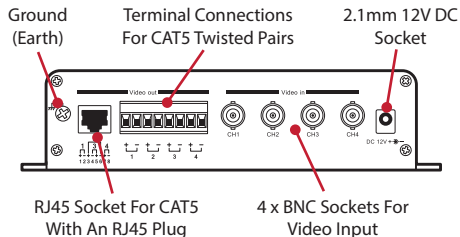

Pairs with Active receiver

See page 44 for active transmitter controls

BAL658 - 8ch Active Balun Receiver



Up to 2km transmission

BAL658 Features

- Terminal strip or RJ45 sockets for connecting CAT5
- 1U 19" Rack-mount design (Brackets included)
- 2 BNC Video outputs for every channel
- Brightness & sharpness controls
- Use as a desktop unit with brackets removed

FUNCTION	SPECIFICATION
Maximum Distance	2000m (With Active Transmitter)
Power / Current	240V AC (PSU Supplied)
Dimensions	430 x 184 x 44mm

BAL658 - Features

DVR End

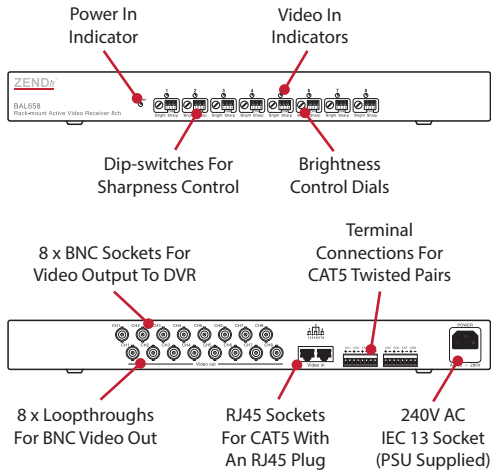

Pairs with Active transmitter

See page 43 for active receiver controls ▼
See page 45 for rack-mount instructions ▼

BAL666 - 16ch Active Balun Receiver



Up to 2km
transmission

BAL666 Features

- RJ45 sockets for connecting CAT5
- 1U 19" Rack-mount design (Brackets included)
- 2 BNC Video outputs for every channel
- Brightness & sharpness controls
- Use as a desktop unit with brackets removed

FUNCTION	SPECIFICATION
Maximum Distance	2000m (With Active Transmitter)
Power / Current	240V AC (PSU Supplied)
Dimensions	430 x 184 x 44mm

BAL666 - Features

DVR End

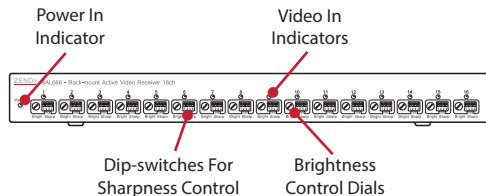

Power In
Indicator

Video In
Indicators

Dip-switches For
Sharpness Control

Brightness
Control Dials

16 x BNC Sockets For
Video Output To DVR

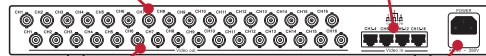

RJ45 Sockets For CAT5
With An RJ45 Plug



16 x Loophroughs
For BNC Video Out

240V AC
IEC 13 Socket
(PSU Supplied)

Pairs with Active transmitter

See page 43 for active receiver controls 
See page 45 for rack-mount instructions 

Fault Finding

Baluns are incredibly reliable. This means if the balun does not work when it is installed you really need to investigate the installation thoroughly.

FAULT	POSSIBLE CAUSE
No Picture	The wrong core colours have been used in the wrong order, re-check the connection order. See pages 11-12.
	There is no power to the camera or the camera is not working. The baluns can only send a video signal down the cable if the video signal is actually there. Make sure the camera is producing a picture using a test monitor.
	Cable is damaged or has an open circuit or short caused by stretching, clipping or when dragged in. Replace cable.
	No power or insufficient power to the active balun.
Poor Picture	The camera is not working properly. The baluns can only send a GOOD signal down the cable if the camera is producing a GOOD picture to start with. Make sure the camera is producing a good picture using a test monitor.
	If you have the polarity of the CAT5 the wrong way around or use two cores from two different pairs you will get unpredictable results so please check pages 11-12 for connections.

For more help & advice visit: zendit.co/tips

Other Products In The Zendit Range

Wirefree Keyfob Kit

- High sensitivity for increased range (Up to 100m)
- Normally open & normally closed contacts
- Relay contacts on each channel
- Screw terminals for easy connection
- 2 Independent channels
- High rejection of unwanted RF signals



CCTV Signage Solutions

A4

Code: SIG550

A3

Code: SIG650



- Unique QR code and scheme ID for quick registration and identification
- FREE online registration
- Easily update scheme details at a later date
- Weatherproof signs with anti-fade ink

WholsWatchingMe.org

The VoiceOFF™ - Programmable Audio Alarm Unit -

Works With:

- PIRs
- Door Contacts
- Panic Buttons
- Break Beams
- Push Buttons
- Pressure Pads



20
Alarm
Inputs

WARN OFF
WITH
VoiceOFF

Deter

Warn

Welcome

Inform

The VoiceOFF is a superb tool for any business. It's a loudspeaker unit that will playback a pre-recorded message when it receives an alarm input.

RS232 input triggers up to 9999 sounds! PLUS 20 alarm inputs trigger 20 user recordable warnings!

Find out more at voiceoff.com

Installer Details:

All specifications are approximate. We reserve the right to change any product specifications or features without notice. Whilst every effort is made to ensure that these instructions are complete and accurate, We cannot be held responsible in any way for any losses, no matter how they arise, from errors or omissions in these instructions, or the performance or non-performance of the equipment that these instructions refer to.



WEE/CG0783SS

This symbol on the products and/or accompanying documents means that used electronic equipment must not be mixed with general household waste. For treatment, recovery and recycling please return this unit to your trade supplier or local designated collection point as defined by your local council.