

# QUAD040

## HandyQuad™

Handbook &  
Instructions



Useful compact quad unit that can be wall mounted or desk mounted.

Multiple display options make it indispensable to the professional CCTV engineer.

4 Camera Inputs with 8 display options *(see pg 14-17)*



Quad



Pic In Pic



H Split



V Split

...and more!

XQUAD040



Free Remote



- 8 Display Modes
- Wall Or Desk Mounted
- Compact Design
- Easy Channel Selection
- Built In Switcher
- Quad Display
- 12V DC
- Push Button Freeze Function

The HandyQuad is a compact, simple to use quad and switcher combined. The HandyQuad can be wall or desk mounted, which along with its tiny size makes for a neat and easy installation.

All the HandyQuad's functions can be controlled using the IR remote control, or the push buttons on the front of the unit.

With 8 adjustable display modes it's easy to view any or all of the four cameras connected.

### Wall Or Desk Mounting The HandyQuad

The HandyQuad can be wall or desk mounted.

To mount it on a wall, use 4 small headed screws into a wall using the spacing in the diagram on the left. The quad is held in position by lowering it on the screw heads.

Alternatively you can simply sit the quad on a desk or shelf. 4 small self-adhesive feet are supplied with the quad that you can attach to the bottom of the quad if you are desk mounting it.

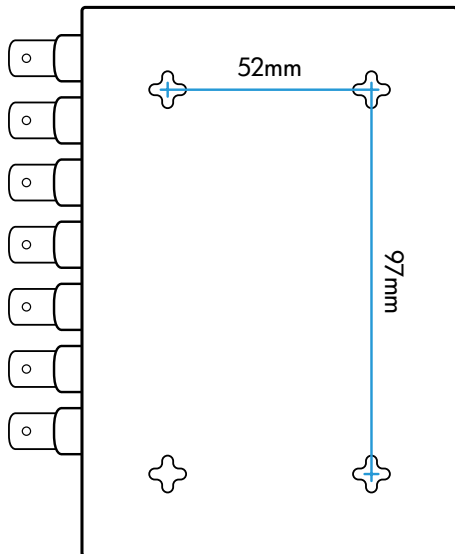

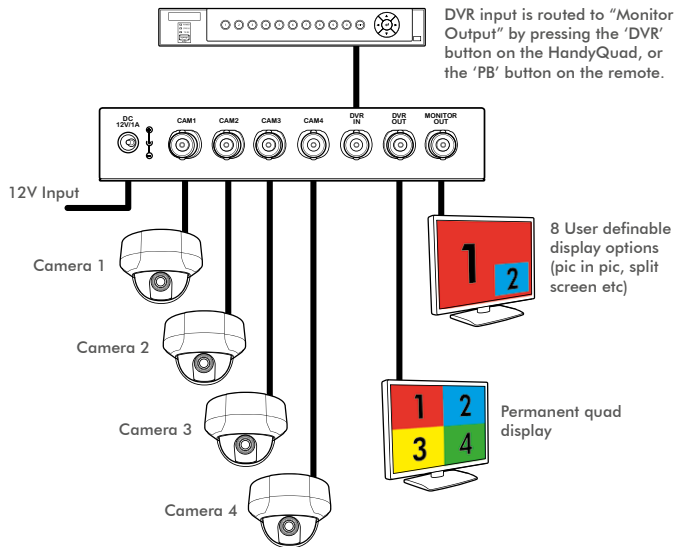

The HandyQuad is really simple to wire up.

Just connect the 4 camera inputs to the BNC connectors labelled "CAM1-4".

The monitor simply connects to the BNC output labelled "Monitor out".

The "DVR In" connection is routed to "Monitor Output" by pressing the "DVR" button on the HandyQuad or the "PB" button on the remote.

The "DVR Out" is a permanent quad display. This can be connected to a single channel on a DVR, alternatively it can be connected to a second monitor.

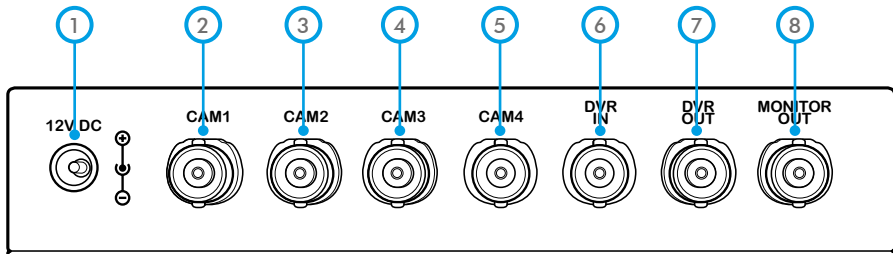

No.	Description	No.	Description
1	12V DC Power Input	5	Camera 4 Input
2	Camera 1 Input	6	DVR / VCR In
3	Camera 2 Input	7	DVR / VCR Out - Displays Quad Screen Constantly
4	Camera 3 Input	8	Monitor Video Out (Composite Only)

### Powering the HandyQuad

Our high quality, reliable AntiHum power supplies are ideal for use with the HandyQuad. We offer a 12V DC, 500mA

power supply with an industry standard 2.1mm DC plug.

Order Code: **POW150**

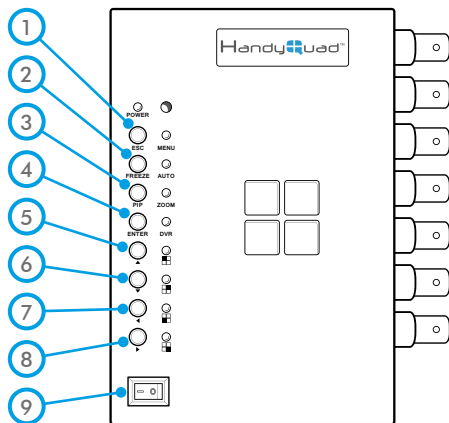

No.	Button	Short Press	Long Press
1	ESC	Quad View	Menu / Exit
2	FREEZE	Freeze Camera(s)	Auto Switch
3	PIP	1x Dual PIP, 2x PIP 3x Vertical Split 4x Horizontal Split 5x Dual Display	Zoom
4	ENTER	OK / Display Setup	DVR / VCR
5	▲	Ch 1 / Up	-
6	▼	Ch 2 / Down	-
7	◀	Ch 3 / Left	-
8	▶	Ch 4 / Right	-
9	POWER	Power On/Off	-

## How to program channels in display modes

To program the channel you require, press the display mode you wish to program (on the remote or front panel) so it appears on your screen.

Press the **Enter** button. The first channel number will begin to flash. Use the **Left** and **Right** arrow keys to scroll through until you find the channel you require.

Next press the **Up** or **Down** arrow keys to program the next channel or frame position in the same way.

Once all the channels have been programmed press **Enter** to save and exit.

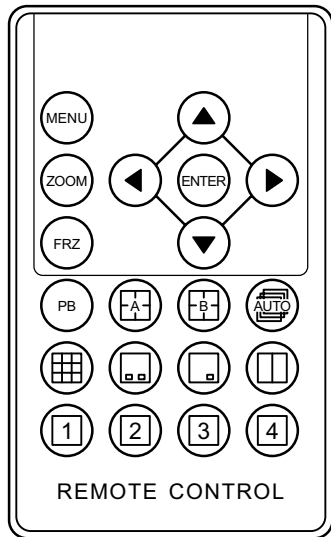

Button	Function	Button	Function
MENU	Menu / Exit	ZOOM	Zoom / 2x Exit Zoom
FRZ	Freeze Current Image / 2x Unfreeze	ENTER	OK
▲	Up	▼	Down
◀	Left	▶	Right
PB	Display DVR / VCR Image / 2x Exit		Quad View
	N/A		Start Auto-Switch
	N/A		Dual PIP
	PIP		1x Vertical Split 2x Horizontal Split 3x Dual Display
	Ch 1 Full screen		Ch 2 Full screen
	Ch 3 Full screen		Ch 4 Full screen

See opposite for setting channels in PIP, Dual PIP, Vertical Split, Horizontal Split and Dual Display.



### Main Menu

The HandyQuad has a really simple and easy to use menu system.

Pressing **Menu** on the IR remote control, or holding **ESC** on the HandyQuad's front panel will display the Main Menu. From here the **Up** and **Down** arrows are used to select the option/field required. The **Left** and **Right** arrows are used to change values and **Enter** is used to confirm selection.

Pressing **Menu** whilst in the menu system will go back one screen. Pressing the **Menu** button whilst the Main Menu is displayed exits the menu system.





### System Setup

The System Setup menu allows you to change the basic settings of the HandyQuad. The **Date**, **Time**, **Video Format**, **Language** and **Key Lock** can be adjusted and set in the System Setup menu.

In the UK the video format needs to be set to **P** (PAL).

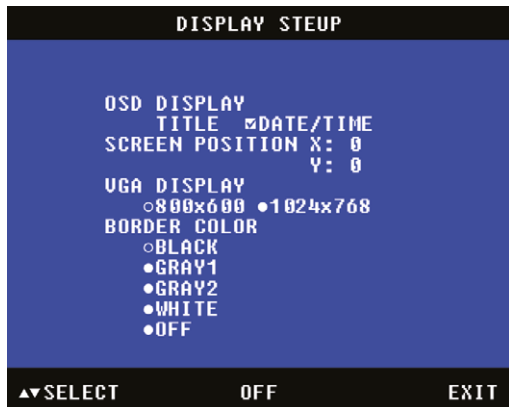

### Display Setup

In the Display Setup you can configure the **OSD**, **Display Resolution** and **Border Colour**. It is also possible to alter the **Screen Position** by setting both the X and Y values.

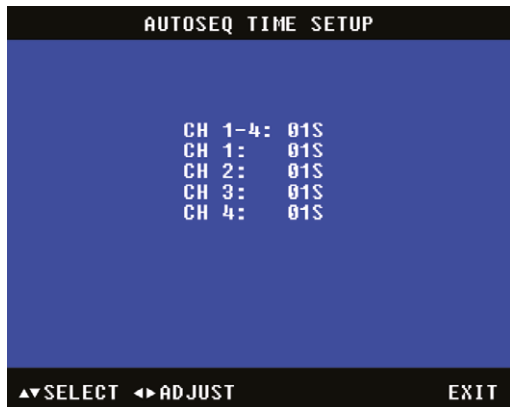

### Autoseq Time Setup

In this menu you can specify how long each channel is displayed for during auto switch view. If required channels can be set to 'OFF' so that they are not displayed. The CH 1-4 value is for the quad view.



### Channel Setup

In Channel Setup you can configure each channel separately to get the best image possible. You are able to set the channel **Title** (Max 4 characters), **Brightness**, **Contrast**, **Saturation**, **Hue** and **Sharpness**.

You also have the option to **Mirror** the image either vertically or horizontally.

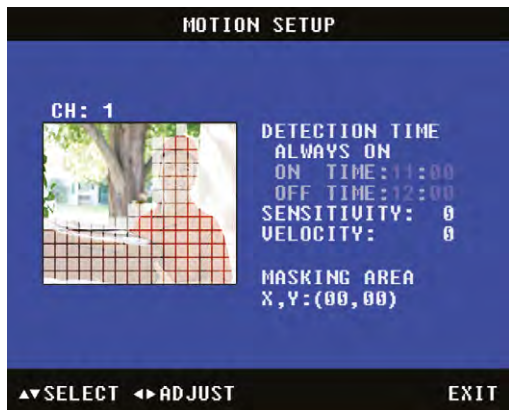

### Motion Setup

In this menu you can configure Motion Detection for each channel.

You can set the period of time you require Motion Detection to be enabled. Alternatively you can choose 'Always On' for constant detection.

The **Sensitivity**, **Velocity** and **Masking Area** can also be set. (Once masking area has been set, move the cursor to the top of the frame to exit)

The **Sensitivity** value can be set from -7 (Min) to +7 (Max). The higher the sensitivity value the more sensitive the HandyQuad is to slight movements.

The **Velocity** value determines how sensitive the HandyQuad is to speed. If the velocity value is set low such as -6 or Min, slow moving objects will not be detected.

**EVENT SETUP**

BUZZER/REPORT CONTROL

CH NO	1	2	3	4	5	6	7	8
ALARM	<input type="checkbox"/>	<input type="checkbox"/>	<input type="checkbox"/>	<input type="checkbox"/>	<input type="checkbox"/>	<input type="checkbox"/>	<input type="checkbox"/>	<input type="checkbox"/>
LOSS	<input checked="" type="checkbox"/>	<input checked="" type="checkbox"/>	<input checked="" type="checkbox"/>	<input checked="" type="checkbox"/>	<input type="checkbox"/>	<input type="checkbox"/>	<input type="checkbox"/>	<input type="checkbox"/>
MOTION	<input type="checkbox"/>	<input type="checkbox"/>	<input type="checkbox"/>	<input type="checkbox"/>	<input type="checkbox"/>	<input type="checkbox"/>	<input type="checkbox"/>	<input type="checkbox"/>

BUZZER HOLD TIME: 05S  
 REPORT HOLD TIME: 30S  
 ALARM POLARITY: LOW

▲▼◀▶SELECT      OFF      EXIT

## Event Setup

The Event Setup menu allows you to set what events are logged in the **Event Report**. The **Report Hold Time** is the minimum amount of time after an event has been logged before an event of the same type on the same channel can be logged again. (The Buzzer is disabled on this model.)

**EVENT REPORT**

1/6 PAGE

NO	Y- M- D	H: M: S	CH	EVENT
01	14-01-01	00:08:88	01	L
02				
03				
04				
05				
06				
07				
08				
09				
10				

LIST CLEAR: ENTER

▲▼SELECT   ◀▶SELECT PAGE      EXIT

## Event Report

The Event Report menu displays a detailed list of all the events that have occurred. A maximum of 60 events can be recorded.



### Full Screen

Each channel can be displayed full screen by pressing the corresponding button on the remote, or on the front of the HandyQuad unit. This makes it easy to quickly switch between camera inputs.



### Quad

Quad view is a great way to display all four images at once ensuring nothing is missed.



### PIP (Picture In Picture)

PIP is ideal for when you have a main camera that requires constant observation, but also a second location to keep an eye on. e.g. A main entrance and a side entrance to a property.

For channel and position setup see pg 6.



### Dual PIP (Picture In Picture)

Dual PIP works in the same way as PIP with the added benefit of a third image. The smaller image frames can be rearranged so as to not obstruct anything important in the main image.

For channel and position setup see pg 6.



### Vertical Split

In Vertical Split mode you can display any two cameras side by side full screen. As this narrows the frame only the centre portion of each image is visible.

For channel setup see pg 6.

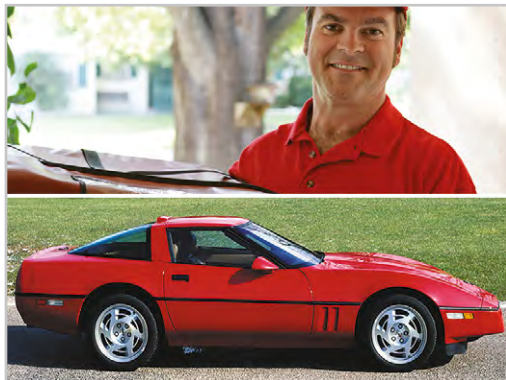

### Horizontal Split

Much like Vertical Split, Horizontal Split displays any two cameras stacked one on top of the other. Horizontal Split provides a wider field of view but again only the centre section of the image is displayed.

For channel setup see pg 6.



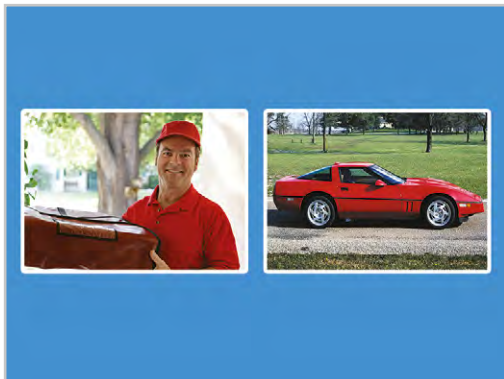

## Dual Display

A great way to view two cameras at the same time. The full image of both cameras is displayed.

For channel setup see pg 6.

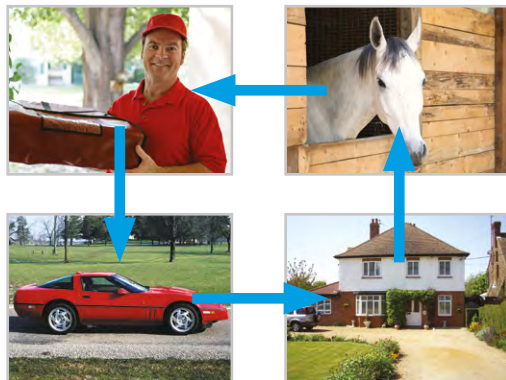

## Auto Switching

Auto switch constantly cycles through all four camera inputs and the quad display. The amount of time each channel is displayed can be adjusted. Each camera can be turned off if not required during auto switch.

## Other Products To Consider - CAM220 Dome Camera



**MiRs**  
Maximum IR  
Sensitivity 

With a built in Balun the CAM220 can be installed with either CAT5 or Composite co-ax cable allowing flexible installation options. The camera's menu can be controlled by "up the co-ax telemetry" (PELCO-C) or additional 2-wire telemetry (PELCO-D) making it easier to set up on site and remotely.

- Auto Digital Zoom
- Dual Voltage 12V DC, 24V AC
- Built in Balun
- Pelco D - (RS485 2 wire)
- Pelco C - (Up the co-ax)
- 700TVL colour mode - 800TVL B&W mode
- NiteDevil low light – 0.00019Lux
- Internal connections – no flying lead
- Vandal-proof & Weatherproof
- 3 Axis Gimbal for wall or ceiling mounting
- Mega-pixel 2.8 ~ 12 mm Auto Iris Lens
- Metal housing with Polycarbonate dome

Dual power (12V DC and 24V AC), a clever internal connection PCB for neat and fast installation and stunning picture quality make the CAM220 a great first choice CCTV Dome camera for any installation.

Order Code: [CAM220](#)

# Other Products To Consider - CAM220 Dome Camera

## 1 Zoom Adjustment

Unlocking this screw allows you to adjust the zoom in and out of the camera.

## 2 Focus Adjustment

Unlocking this screw allows you to re-adjust the focus of the camera after adjusting the zoom.

## 3 Tilt Axis

Unlock this screw and one on the other side to tilt the camera up and down.

## 4 Rotational Axis

Turn this to rotate the cameras output image so that it is correct on a monitor.  
*(Loosen tilt screws first)*

## 7 Video Out - Main

Connect your co-ax to this for the main Video output.

## 8 Video Out - Spare

Spare video out for local test using a test monitor.

## 5 Left-Right Axis

Unlock these screws to adjust the left-right orientation of the camera.  
*(2 Screws, 1 either side)*

## 6 Connection Block

Spring lock connections to wire up the camera.

## 9 Joystick

Press down to bring up the OSD then navigate using the joystick. Down again is select.

## 10 Conduit Entry

20mm blank supplied.

*(Cable entry also at rear through a grommet)*

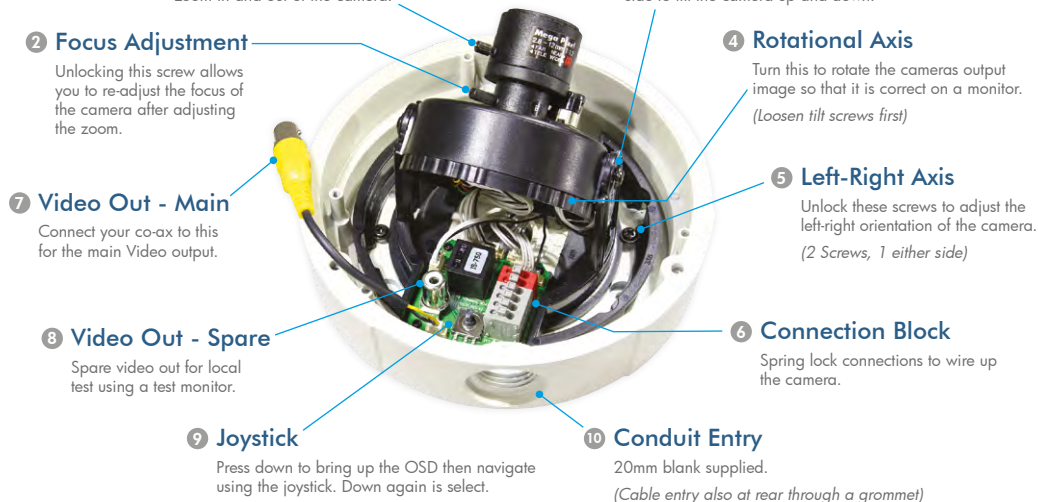

# 10 Reasons the alienHero DVR is great value for money

alienHero 16ch



1. **Built-in Video Analytics** (*finds evidence instantly!*)
2. **True Realtime D1 Recording** (*even on the 16ch*)
3. **High Definition HDMI Output** (*along with VGA & BNC*)
4. **Easy to Use Interface** (*said to be best in class*)
5. **AutoPort Plug-and-Play** (*for easy internet setup*)
6. **Compact Space Saving Case** (*slim modern design*)
7. **Free Dynamic DNS Setup** (*saves you time*)
8. **Full Alarm Inputs** (*16 on the 16 way*) - (*triggered how you want*)
9. **Bespoke Software Available** (*you want it, we write it*)
10. **Video Tagging** (*tag recording with keywords such as "theft"*)

#### Order Codes

4ch 1TB: ALIEN654K

8ch 1TB: ALIEN658K

16ch 2TB: ALIEN666N

# Other Products To Consider - CCTV Mule

## Sends 4 video signals down 1 co-ax



The CCTV Mule makes it easy to add extra cameras to existing installations, you save installation time and reduce the cost of buying and installing more cable.

The Mules work in pairs. One Mule combines the video signals to transmit them down 1 single co-ax, the other Mule then reconstructs the individual video signals at the remote end. A low-cost, easy solution that offers huge installation benefits and opportunities to add extra cameras.

The clever electronics of the CCTV Mule also allow it to carry audio and RS485 data along the same co-ax cable. You can even carry three video signals in one direction and a fourth signal in the other direction!

Order Code: MULE004 (4-Way Pair)

Order Code: MULE002 (2-Way Pair)

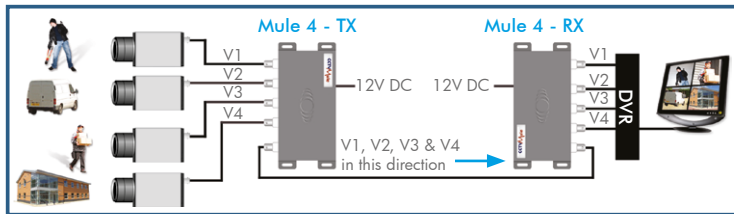

### Specification

Voltage - 12V DC, Tx 200mA, Rx 350mA  
Video inputs - 4, outputs - 1 Tx  
Video inputs - 1, outputs - 4 Rx  
Video quality - D1 @ 25fps - Every Camera  
Gain control for different cable lengths  
Operation modes - 5 types  
Cable required - RG59 or better  
Max Cable length - 200mtrs  
Size - 175 x 110 x 30mm

Find out more at [www.cctvmule.com](http://www.cctvmule.com)

## Other Products To Consider - VoiceOff

### Programmable Audio Alarm Unit

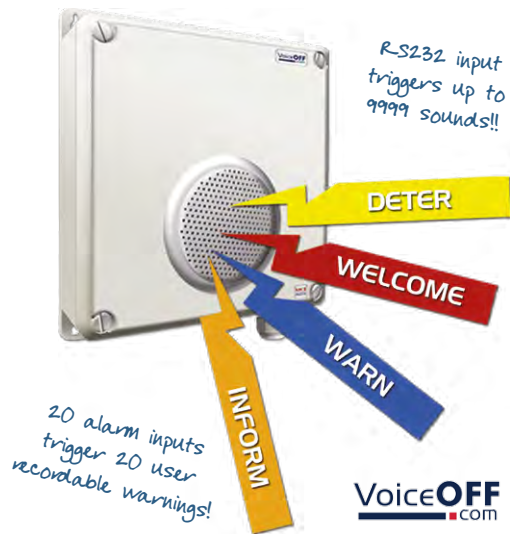

- Trigger Up To 9999 Sounds
- 20 Alarm Inputs Trigger, 20 Recordable Warnings
- Removable SD Card
- Talkback Function
- RS232 Connection
- Weatherproof
- Activate Remotely Over The Internet
- Additional Sound Files Can Be Downloaded at [www.voiceoff.com](http://www.voiceoff.com)

The VoiceOff MK2 is an alarm activated voice or sound warning unit that has 20 separate alarm inputs, to trigger up to 20 different recorded sound files. With the new added feature of an RS232 input you can trigger up to 9999 sounds!

Warning messages can be downloaded or recorded in MP3 format and stored on the removable SD card. These sounds can be used to welcome visitors, deter intruders, warn or inform people as they enter certain areas.

Order Code: VOX200

Find out more at [www.voiceoff.com](http://www.voiceoff.com)

# Other Products To Consider - Useful Tools

## CCTV Test Monitor

[cctvmate.com](http://cctvmate.com)



- PTZ Control Testing
- DC/AC Voltage Tester
- RS485 Data Test Function
- 29 Protocols Supported
- Check Video Signal Strength
- 12V Camera Power Function
- Up to 10 Hours Battery Life
- Network Cable Testing
- Monitor Output Testing

### Kit includes:



Carry case, DC/AC Voltage probes, RS485 Data test cable, Camera power cable, BNC Lead, Neck strap, Network cable tester & PSU.

Order Code: LCD330

## BNC Ratchet Crimp



Crimps - 2pc✓ 3pc✓ Mini 3pc✓



Order Code: TOO980

Learn how to crimp a BNC! See online tip 248

<b>CONTROLS</b>	<b>Push Button</b>
<b>FREEZE FRAME</b>	<b>Yes</b>
<b>DISPLAY MODES</b>	<b>8</b>
<b>POWER INPUT</b>	<b>12V DC - 2.1mm Plug</b>
<b>CURRENT CONSUMPTION</b>	<b>270mA</b>
<b>PSU</b>	<b>Min 500mA PSU Required</b>
<b>IR REMOTE CONTROL</b>	<b>Supplied</b>
<b>VIDEO IN</b>	<b>BNC</b>
<b>VIDEO INPUTS</b>	<b>5 (4x Video, 1x DVR/VCR)</b>
<b>VIDEO OUT</b>	<b>BNC</b>
<b>VIDEO OUTPUTS</b>	<b>2 (1x Monitor, 1x DVR/VCR)</b>
<b>DIMENSIONS</b>	<b>149 x 124 x 28mm</b>

All specifications are approximate. Handy Quad reserves the right to change any product specifications or features without notice. Whilst every effort is made to ensure that these instructions are complete and accurate, Handy Quad cannot be held responsible in any way for any losses, no matter how they arise, from errors or omissions in these instructions, or the performance or non-performance of the equipment that these instructions refer to.



WEE/CG0783SS

This symbol on the products and/or accompanying documents means that used electronic equipment must not be mixed with general household waste. For treatment, recovery and recycling please return this unit to your trade supplier or local designated collection point as defined by your local council.

