

NiteDevil Internal Hi-Res Dome (IR Optional)

These *NiteDevil* IR Internal Dome Cameras produce high quality images and work in very low light conditions down to 0.00001 Lux. They have many features including a 3D axis mounting inner bracket for wall mounting, a SONY SuperHad CCD II and a 2.8mm ~ 12mm varifocal lens. An OSD menu provides options for an exceptional Wide Dynamic Range option, High Sensitivity BLC, motion detection, privacy masking etc with option for RS485 menu control.

Models Available

CAM721 560TVL, 12VDC

CAM722 560TVL, 12VDC/24VAC

CAM741 560TVL, IR, 12VDC

CAM742 560TVL, IR, 12VDC/24VAC



Key Features

- ✓ 1/3" SONY SUPER HAD CCD II
- ✓ Low illumination down to 0.00001 Lux
- ✓ Menu for Motion Detection & camera setup
- ✓ Wide Dynamic Range Function.
- ✓ High Sensitivity Backlight Compensation
- ✓ High Resolution 560TVL (day) 600TVL (night)
- ✓ Surge voltage input protection
- ✓ Privacy Masking (8 zones)
- ✓ 3 Axis 3D built-in bracket
- ✓ Vari-focal 2.8 ~ 12mm Auto DC Iris Lens
- ✓ White Plastic Housing with Smoked Cover
- ✓ 20 x IR 850nm Leds on CAM741/742
- ✓ RS485 remote menu control
- ✓ 3DNR Noise Reduction for night viewing

Mounting the Camera

The camera is for mounting on a wall, ceiling or outdoor fascia board. Note that this camera has a 3D gimble allowing wall mounting or ceiling mounting. Note that fitting the screws into a ceiling will require support for the screws.

Powering the Camera

Note: Do not connect power to the RS485 connections

CAM721

The dome requires a 12V DC regulated power supply. Connections are not polarity sensitive so the positive and negative cables can be connected either way around. The camera is provided with a fly lead with a terminal connector for power. This camera draws a maximum of 140mA at 12v DC. Ensure that a regulated power supply is used and allow adequate headroom i.e only use a power supply with a minimum rating of 200mA.

CAM722

This dome is dual voltage. It will work on 12vDC or 24vAC. Connections are not polarity sensitive so therefore power connections can be either way round. The camera is provided with a fly lead with a terminal connector for power. This camera draws a maximum of 200mA. Ensure that a regulated power supply is used if using 12vDC and allow adequate headroom i.e only use a power supply with a minimum rating of 300mA.

CAM741

The dome requires a 12V DC regulated power supply. Connections are not polarity sensitive so the positive and negative cables can be connected either way around. The camera is provided with a fly lead with a terminal connector for power. This camera draws a maximum of 350mA at 12v DC when IR LEDs are on. Ensure that a regulated power supply is used and allow adequate headroom i.e only use a power supply with a minimum rating of 500mA.

CAM742

This dome is dual voltage. It will work on 12vDC or 24vAC. Connections are not polarity sensitive so therefore power connections can be either way round. The camera is provided with a fly lead with a terminal connector for power. This camera draws a maximum of 430mA. Ensure that a regulated power supply is used if using 12vDC and allow adequate headroom i.e only use a power supply with a minimum rating of 600mA.

Connecting the camera to control equipment.

The dome camera comes with a fly lead for video out. To reduce installation time the video out lead is terminated into a male BNC connector. This allows the installer to connect the camera to control equipment via a female BNC-BNC lead. A special setup joystick controller is located on the side of the PCB board and this allows access to the OSD menu. A special socket is located to the right of the joystick controller to connect an optional test video monitor lead.

RS485 Connection

The RS485 connection allows access to the menu using a keyboard or DVR PTZ operation using an IRIS OPEN to open menu and select options using near, far, open and closed. Connect Green to Transmit + and Blue to Transmit -.

Installation

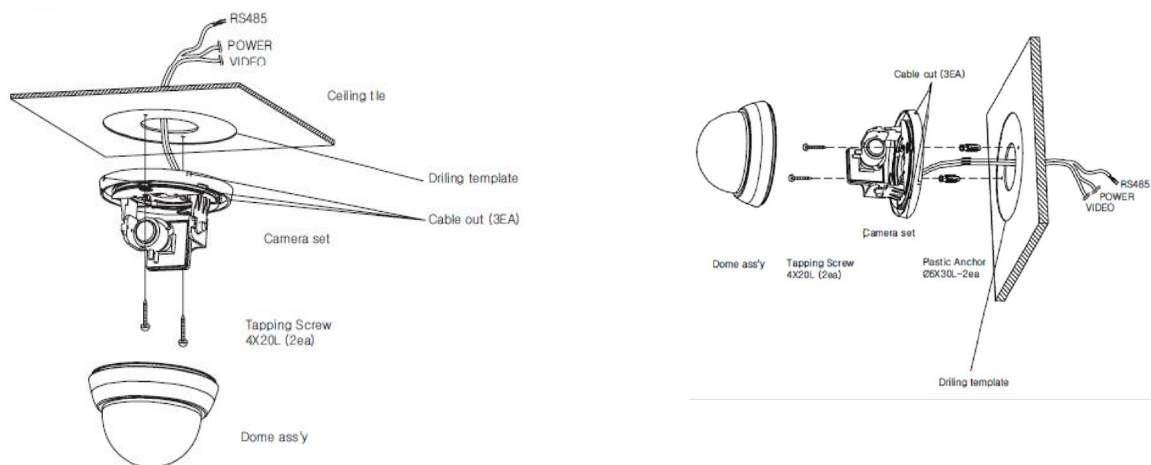

1. Drill holes in wall or ceiling using template.
2. Screw dome baseplate to wall or ceiling.
3. Adjust camera zoom, focus and menu settings and then clip on dome cover.
4. These cameras have a 3D axis allowing the camera to be fitted directly on a wall. They have a 360° panning axis, 90° tilt axis and 180° rotation axis.

Panning: Hold the camera base and grip camera mechanism on both sides and turn it slowly to position required.

Tilt: Loosen the screws on both sides and tilt the lens to required position.

Rotation: Hold the camera board in one hand and rotate the lens to adjust picture.

Adjusting Zoom and Focus

In order to adjust zoom and focus, if you have the IR model, you will need to remove the IR cover. This is easily unclipped. Now adjust the zoom and focus settings controls. Loosen the controls using a small screwdriver. You may find it easier to set the Zoom control first and then adjust the Focus.

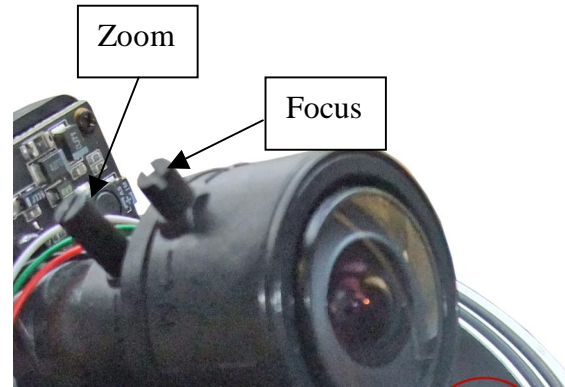

Retighten the Zoom and Focus controls.

OSD (On Screen Display) Function

Remove the dome cover to access the PCB board for entering the menu.

1. If you want to use the test monitor lead supplied, plug it into the Test Monitor Connection shown in diagram. The spare short lead is a spare extension.
2. The OSD menu is accessed by first pressing down the centre button (SET Button).
3. Move button upwards to move down menu.
Move button downwards to move up menu
Move button right to move right
Move button left to move left
Press button down to Enter.

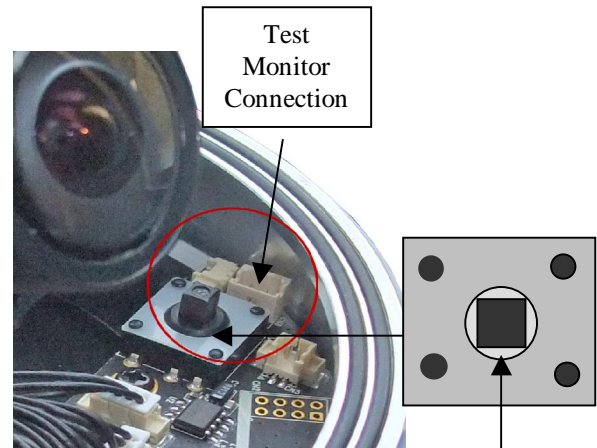

**Menu Set
Button
Press
Down**

The following menu will be displayed on your monitor on pressing SET button (Joystick controller):

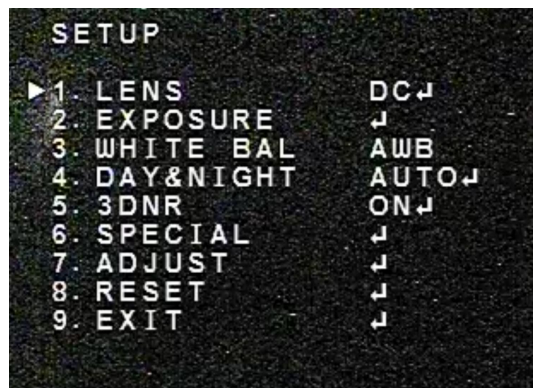

Menu Structure Functions

LENS	DC	MANUAL		
EXPOSURE	SHUTTER BLC	BRIGHTNESS D-WDR	AGC RETURN	SENS-UP
WHITE BALANCE	ATW	MANUAL	AWC SET	PUSH
DAY/NIGHT	COLOUR	B/W	AUTO	
3DNR	ON	OFF		
SPECIAL	CAMTITLE PRIVACY	D-EFFECT SYNC	RS485 LANGUAGE	MOTION RETURN
ADJUST	SHARPNESS	BLUE	RED	RETURN
RESET	FACTORY	RETURN		
EXIT				

NOTE: All items with the icon allow you to access a submenu by pressing the SET button down. Any item showing - - - icon functionality is not available on this camera.

SPECIAL NOTE: SENS UP is the NITEDEVIL option

1. When SHUTTER is in Manual mode, SENS UP does not operate.
2. When AGC is turned off, SENS UP does not operate.

1. LENS

This function is used to select the lens and to match the SETUP suitable for the type of lens used. These cameras have a DC direct Drive Lens.

- 1) Press the SETUP button.
- 2) The LENS on the menu will automatically display <DC> in the sub-menu. If this sub-menu shows <MANUAL>, please press the sub-menu and it will be converted to <DC>.
- 3) **DC Brightness control**
Brightness level of the screen mode is adjustable at <DC>. Select SHUTTER menu and move the cursor to sub-menu <DC>. Press SETUP button and then the BRIGHTNESS CONTROL menu is on. Adjust the level by using the LEFT/RIGHT buttons.
- 4) Press the SETUP button to finish the control.

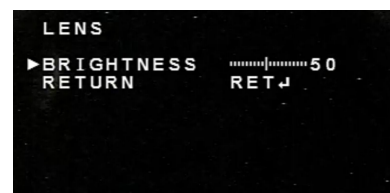
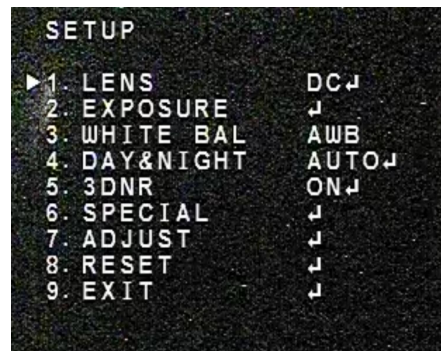

2. EXPOSURE

FIXED : 1/60, 1/50...1/100000

This mode is activated when the IRIS is set to <FIXED> mode and when manual iris lens is used only. Following 7 steps are adjustable according to scanning system.

PAL : 1/50, FLK, 1/250, 1/500, 1/2000, 1/5000, 1/10000, 1/100000

Use this function only when the light level on the application is fixed all the time. Factory default is PAL 1/50



FLK

Please select FLK mode when flickering occurs on the screen, due to an imbalance between illumination and frequency.

AUTO

The shutter speed is controlled automatically according to the brightness of the screen.

Note Brightness is adjustable from 00 ~100.(Default : 50)

Auto mode activates only when Lens is set to MANUAL.

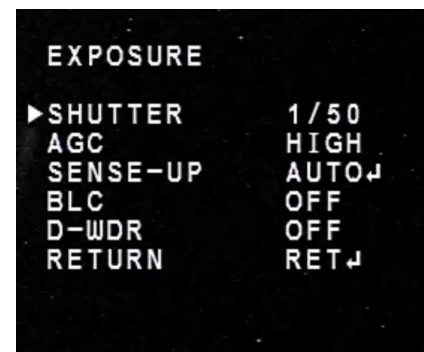

SHUTTER: 1/50 /x2/x4/x8/x16/x32/x64/x128/x256/ 1/100000 / 1/10000 / 1/5000 / 1/2000 / 1/1000 / 1/500 / 1/250

AGC (Auto Gain Control)

Please select the mode you wish to operate by pressing the LEFT and RIGHT buttons. As the level of gain increases, the screen gets brighter and the level of noise increases.

HIGH : The gain increases from 6dB up to 42dB

MIDDLE : The gain increases from 6dB up to 30dB

LOW : The gain increases from 6dB up to 18dB

OFF : The gain is fixed at 6dB.

Note: AGC levels cannot be selected when the Day/Night mode is set to AUTO.

SENS-UP (NiteDevil Feature) OFF / AUTO

This is an electronically activated function to improve the sensitivity for viewing low light conditions in addition to the original sensitivity from the CCD sensor itself.

SENS UP helps maintain a bright, clear screen image by automatically detecting changes in light in low illumination. When SENS-UP level is increased, a bright picture becomes white and more ghosting occurs. When SENS-UP function is in operation, noise, spots and white haze is increased as the SENS-UP level increases.

AUTO : Set Sens-Up to x2, x4, x8, x16, x32, x64, x128, x256.

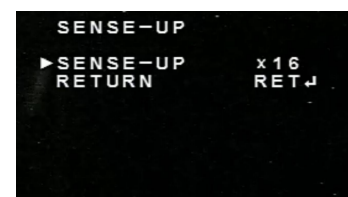

Special Note: When the Shutter is in **Manual** mode and/or **AGC** is off, Sens Up does not operate.

BLC (Backlight Compensation) OFF / BLC / HSBLC

This function is useful when there is a strong backlight behind the object.

HIGH : The gain increases from 0dB up to 42dB

MIDDLE : The gain increases from 0 dB up to 30dB

LOW : The gain increases from 0 dB up to 18dB

OFF : BLC function does not operate.



HSBLC (Highlight Suppression Backlight Compensation)

If there is a bright light installed, reducing the bright light can make it possible to view a car registration plate.

Target Area



HSBLC ON

HSBLC OFF

D-WDR (Digital Wide Dynamic Range)

The Digital Wide Dynamic Range function scans both dark and bright areas separately and then merges the two images, providing a picture with balanced lighting.

-INDOOR

Select this when the level is low.

-OUTDOOR

Select this when the level is high.



WDR OFF



WDR ON

Note D-WDR automatically turns off when the Day/Night mode is set to AUTO.

D-WDR needs be manually turned ON/OFF when the Day/Night mode is set COLOR or B/W.

RETURN

Select this to save the change in the EXPOSURE menu and return to the SETUP menu.

3. WHITE BAL (White Balance)

This is useful when the cameras are installed in different artificial lighting conditions where a standard White Balance condition is not suitable for all.

There are 5 options:

AWB, ATW, OUTDOOR, INDOOR & AWC-SET

AWB (Auto White Balance)

This mode is generally used indoors as it has a narrow temperature range when light levels remain relatively static.

ATW (Auto Tracking White Balance)

This mode can be used within the colour temperature range 2000°K ~ 20000°K. This mode is generally used for outdoor use where a wider range of colour is required.

OUTDOOR

This mode is specifically designed for outdoor use.

INDOOR

This mode is specifically designed for indoor use.

MANUAL

The manual adjustment mode makes finer adjustment possible. Please select ATW or AWC first. Please set the appropriate color temperature, and then increase or decrease the red and blue colour values while monitoring the color changes made.

AWC - SET (Auto White Balance control)

Press the menu button whilst the camera is directed at a piece of white paper to obtain the optimum state under current illumination. If the light source changes, you will have to adjust the white balance again.

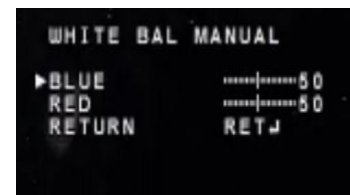

4. DAY & NIGHT

You can display pictures in Color or B/W.

There are 3 options in this menu: AUTO, COLOR & B/W

AUTO : This mode switches to colour during normal daytime running but switches to B/W mode when ambient illumination is low. To set up the switching time or speed for AUTO mode, press the menu button.

DELAY : You can delay the Day/Night switching mode 0-63sec.

D▶N = Day ~ Night - Adjust lux level for switching (Default : 65 (3Lux))

N▶D = Night ~ Day - Adjust lux level for switching (Default : 60 (6Lux))



COLOR : The picture is always displayed in colour.

B/W : The picture is always displayed in black and white. You can set the IR Smart option to OFF/ON and the burst option to OFF/ON.

5. 3DNR (3D Noise Reduction)

Background noise in low light level conditions can be reduced by increasing the 3DNR gain level.



OFF : Deactivates 3DNR, Noise is not reduced.

ON : Activates 3DNR so that noise is reduced.



6. SPECIAL

CAM TITLE

If you enter a title, the title will appear on the monitor.

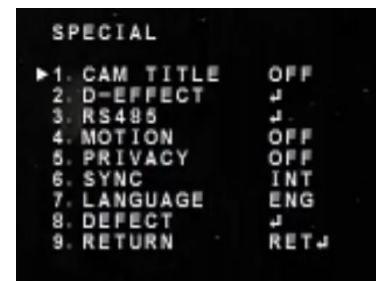
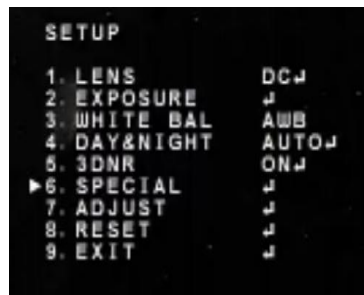

Select ON by using the LEFT and RIGHT menu button.

☞ Note: If OFF is selected, the CAM TITLE will not appear on the monitor even if it has been input. UP to 15 characters are available for the CAM TITLE. Move to the letter required using UP or DOWN buttons. Set a name from A, B, ~ Y, Z, 0, 1 ~ 8, 9 by using UP, DOWN, LEFT and RIGHT menu buttons. Lock in the letters by pressing menu enter button. When the letter is locked, the cursor moves to the next space. Repeat to input CAM TITLE.



☞ Note: If a wrong name has been input, move cursor to CLR and press the menu button and all characters will be cleared. If you want to correct a letter, please move the cursor to the arrow at the bottom left of the screen and press the menu button. The position the cursor on the required character and press the menu button.

When a name has been chosen, please select a position for the name to display. Move the cursor to POS and press menu button. The name will appear at the top left hand corner. Find the position where you wish to display the name by using the 4 directional selections and then press the menu button. Select END and then press the menu button to complete CAM TITLE input.

D-EFFECT

FREEZE : You can view still or moving pictures.

V-FLIP : You can flip the picture vertically on the screen.

MIRROR : You can flip the picture horizontally on the screen.

ROTATE : You can rotate picture on the screen.

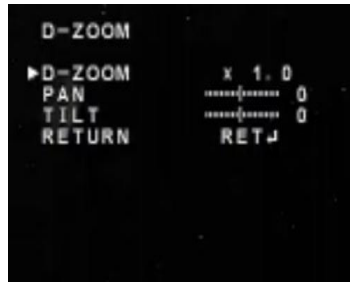
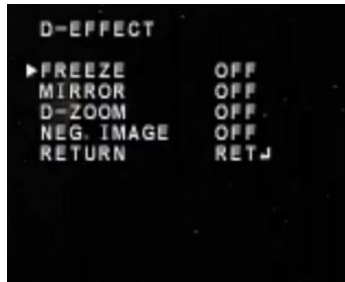

D-ZOOM : You can use a digital zoom of x1 ~ x 32.

PAN : -100 ~ 100 adjusts digital zoomed picture

TILT : -100 ~ 100 adjusts digital zoomed picture

NEG.IMAGE : ON/OFF

RETURN : Select this to save the D-EFFECT menu setting and return to the SPECIAL menu.

RS485

This function allows control of the camera menu via an RS485 controller such as a PTZ keyboard or Alien DVR PTZ function.

CAM ID : Determines the camera's identification number.
(between 0 and 255)

ID DISPLAY : Displays camera title at top left of screen.

BAUDRATE : Select from 2400/4800/9600/19200/38400/57600 bps.

RETURN : Select this to save the RS485 menu setting and return to the SPECIAL menu.



NOTE: THE PROTOCOL IS FIXED ON PELCO-D

MOTION

This option allows up to 4 areas to be set for motion detection and if detection triggered, the MOTION display is flashed.

AREA SELECT : You can select up to 4 MD areas.

AREA DISPLAY : Determines whether to use the MD area selected in AREA SELECT.

LEFT/RIGHT : Determines the position of the horizontal axis.

WIDTH : Determines the size of the horizontal size.

TOP/BOTTOM : Determines the coordinate of the vertical axis.

HEIGHT : Determines the coordinate of the vertical size.

SENSITIVITY : Determines the coordinate of the sensitivity

RETURN : Select this to save the MOTION menu setting and return to the SPECIAL menu.

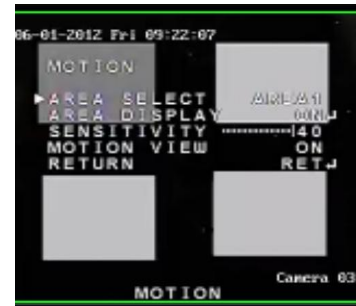

PRIVACY

This is a privacy masking facility allowing you to mask up to 8 areas on the camera picture with the option to select from 16 different colour masks.

AREA SELECT : Select up to 8 PRIVACY masking areas.

AREA DISPLAY : Selected AREA actioned.

LEFT/RIGHT : Set coordinates of horizontal axis.

WIDTH : Set size of the horizontal axis.

TOP/BOTTOM : Set coordinates of vertical axis.

HEIGHT : Set size of vertical axis.

COLOR : Select from 16 PRIVACY colour options.

RETURN : Select this to save the PRIVACY menu setting and return to the SPECIAL menu.

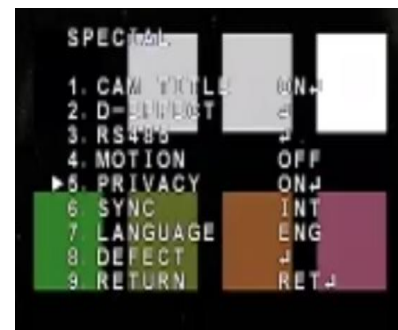

SYNC

Menu is fixed in INT mode.

LANGUAGE

You can select the menu language according to you requirements.

- ENGLISH / KOREAN / JAPANESE / CHINESE 1,2

DEFECT

This options clears pixel noise.

RETURN

Select this to save the SPECIAL menu settings and return to the SETUP menu.



ADJUST

SHARPNESS

As you increase this value, the picture outline becomes stronger and clearer. Adjust this value appropriately depending on the sharpness of the picture.

BLUE

Blue colour gain adjustable.

RED

Red colour gain adjustable.

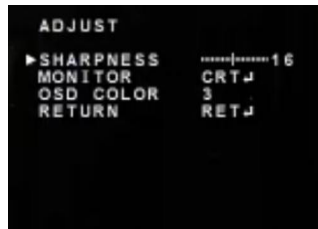

RESET

Reset the camera settings to the factory defaults.

EXIT

Press the SET button in the EXIT menu to save the current setting and exit the SETUP menu.

DIMENSIONS

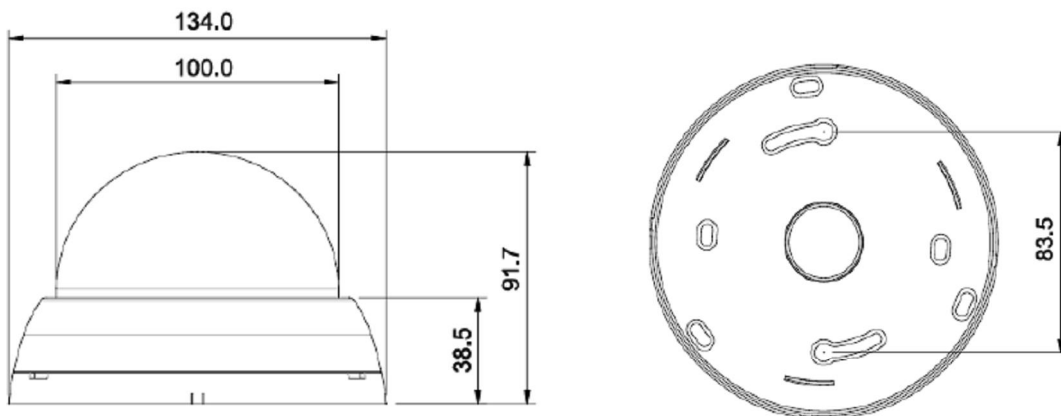

TECHNICAL SPECIFICATIONS

Model No	CAM721	CAM722	CAM741	CAM742
Operating Current	12vDC 140mA	12vDC 140mA or 24vAC 200mA	12vDC 350mA	12vDC 350mA or 24vAC 430mA
IR LEDs	No		20 x 850nm IR Leds	
IR beam distance	No		Up to 30 metres	
Weight	450 grms		600 grms	
Lens	2.8 ~ 12mm DC Iris Lens/F1.2		2.8 ~ 12mm DC Iris Lens (ICR)	
Image Sensor	1/3" Sony Super HAD CCDII			
Effective Pixels	PAL: 752(H) x 582(V)			
Horizontal Resolution	560TVL (Day) 600TVL (Night)			
Synchronising System	Internal			
Scanning System	625 Lines 2:1 Interlaced			
Video Output	1.0v p~p composite 75 ohms			
Signal to Noise Ratio	More than 52dB (AGC Off)			
Minimum Illumination	0.00001 Lux/F1.2 (Sens-Up) 0.2 Lux/F1.2			
Shutter Speed	NTSC: 1/60 ~ 1/100000 sec PAL: 1/50 ~ 1/100000 sec			
Gamma Correction	Standard r = 0.45 (OSD)			
White Balance	2000K ~ 20000K auto			
Gain Control	6dB ~ 40dB Off / Low / Middle / High			
Smear Effect	0.005%			
Power Source	12vDC		12vDC or 24vAC	
Operating Temperature	-10°C ~ +50°C			
Humidity	Within 90% RH			
Measurements	134mm (D) x 91.7 (H)			
OSD MENU				
White Balance	ATW / PUSH / MANUAL / AWC			
Sens-up	X2 ~ x128			
Privacy Masking	Off / On (8 x programmable zones)			
Motion Detection	Off / On (4 zones)			
Digital Zoom	Off / On (x1 ~ x32)			
3DNR	Off / On			

All specifications are approximate. nitedevil.com reserves the right to change any product specifications or features without notice. Whilst every effort is made to ensure that these instructions are complete and accurate, nitedevil.com cannot be held responsible in any way for any losses, no matter how they arise, from errors or omissions in these instructions, or the performance or non-performance of the equipment that these instructions refer to.



This symbol on the products and/or accompanying documents means that used electronic equipment must not be mixed with general household waste. For treatment, recovery and recycling please return this unit to your trade supplier or local designated collection point as defined by your local council.

WEE/CG0783SS