



## **The new DVR365 Digital Video Recorder**

H264 Compression – High Resolution

Model DSD400 Series



## **Operations Manual**

Version 1

# Table of Contents

<b>1</b>	<b>FEATURES AND SPECIFICATIONS .....</b>	<b>9</b>
1.1	FEATURES.....	9
1.2	SPECIFICATIONS.....	9
<b>2</b>	<b>OVERVIEW AND CONTROLS .....</b>	<b>12</b>
2.1	FRONT PANEL .....	12
2.2	REAR PANEL .....	16
2.2.1	Overview .....	16
2.2.2	Connection Sample .....	17
2.3	REMOTE CONTROL.....	18
2.4	MOUSE CONTROL.....	18
2.5	VIRTUAL KEYBOARD AND FRONT PANEL .....	20
2.5.1	Virtual Keyboard .....	20
2.5.2	Front Panel.....	20
<b>3</b>	<b>INSTALLATION AND CONNECTIONS .....</b>	<b>21</b>
3.1	CHECK UNPACKED DVR .....	21
3.2	HDD INSTALLATION .....	21
3.2.1	Choose Serial HDDs .....	21
3.2.2	Calculate HDD Size.....	21
3.2.3	HDD Installation.....	21
3.3	CD/DVD BURNER INSTALLATION .....	22
3.4	DESKTOP AND RACK MOUNTING.....	23
3.4.1	Desktop Mounting .....	23
3.4.2	Rack Mounting .....	23
3.5	CONNECTING POWER SUPPLY .....	23
3.6	CONNECTING VIDEO INPUT AND OUTPUT DEVICES .....	23
3.6.1	Connecting Video Input .....	23
3.6.2	Connecting Video Output.....	24
3.7	CONNECTING AUDIO INPUT/OUTPUT & LOOPTHROUGH.....	25

3.7.1	Audio Input/One Audio Output .....	25
3.7.2	Looping video .....	26
3.7.3	Matrix Video Output (optional).....	26
3.7.4	Alarm Input and Relay Output .....	26
3.7.5	Alarm Input .....	26
3.7.6	Alarm Output.....	27
3.7.7	Alarm Input and Output Details .....	27
3.7.8	Relay Output Description.....	28
3.8	RS232 .....	29
3.9	RS485 .....	30
3.10	OTHER INTERFACES .....	30
<b>4</b>	<b>OVERVIEW OF NAVIGATION AND CONTROLS .....</b>	<b>31</b>
4.1	LOGIN, LOGOUT & MAIN MENU .....	31
4.1.1	Login .....	31
4.1.2	Main Menu .....	31
4.1.3	Logout .....	32
4.1.4	Auto Resume after Power Failure.....	32
4.1.5	Replace Button Battery (If DVR loses time or will not display correct date/time) .....	32
4.2	RECORDING OPERATION .....	33
4.2.1	Live Viewing .....	33
4.2.2	Manual record.....	33
4.3	SEARCH & PLAYBACK.....	35
4.3.1	Search Menu .....	35
4.3.2	Basic Operation.....	36
4.3.3	Calendar.....	38
4.4	RECORD SETUP (SCHEDULE) .....	38
4.4.1	Schedule Menu .....	38
4.4.2	Basic Operation .....	39
4.5	DETECT .....	40
4.5.1	Go to Detect Menu.....	40
4.5.2	Motion Detect.....	40
4.5.3	Video Loss .....	43
4.5.4	Camera Masking.....	44
4.6	ALARM SETUP AND ALARM ACTIVATION .....	45
4.6.1	Go to alarm setup interface.....	45
4.6.2	Alarm setup .....	45

4.7	BACKUP .....	47
4.7.1	Detect Device .....	47
4.7.1	Backup.....	48
4.8	PTZ CONTROL AND COLOUR SETUP .....	49
4.8.1	Cable Connection .....	49
4.8.2	PTZ Setup.....	49
4.8.3	3D Intelligent Positioning Key.....	51
4.9	PRESET/ PATROL/PATTERN/SCAN .....	51
4.9.1	Preset Setup.....	52
4.9.2	Activate Preset.....	53
4.9.3	Patrol setup (Tour Setup).....	53
4.9.4	Activate Patrol (tour) .....	53
4.9.5	Pattern Setup.....	53
4.9.6	Activate Pattern Function.....	54
4.9.7	Auto Scan Setup .....	54
4.9.8	Activate Auto Scan.....	54
4.10	FLIP .....	54
<b>5</b>	<b>MENU OPERATIONS AND CONTROLS.....</b>	<b>55</b>
5.1	MENU TREE.....	55
5.2	MAIN MENU.....	55
5.3	SETTING.....	56
5.3.1	General .....	56
5.3.2	Encode.....	58
5.3.3	Schedule .....	60
5.3.4	RS232.....	60
5.3.5	Network.....	61
5.3.6	Alarm.....	68
5.3.7	Detect .....	68
5.3.8	Pan/Tilt/Zoom.....	68
5.3.9	Display .....	68
5.3.10	Default .....	70
5.4	SEARCH.....	71
5.5	ADVANCED.....	71
5.5.1	HDD Management .....	71
5.5.2	Abnormity.....	72
5.5.3	Alarm Output.....	73
5.5.4	Manual Record.....	73

5.5.5	Account .....	73
5.5.6	Auto Maintain.....	74
5.5.7	TV Adjust.....	74
5.5.8	Video Matrix (For GBEH--S and GBEL-S Series only) .....	75
5.6	INFORMATION .....	79
5.6.1	HDD Information.....	80
5.6.2	BPS.....	80
5.6.3	Log .....	81
5.6.4	Version .....	81
5.6.5	Online Users .....	82
5.7	EXIT .....	82
<b>6</b>	<b>ABOUT AUXILIARY MENU .....</b>	<b>84</b>
6.1	GO TO PAN/TILT/ZOOM MENU .....	84
6.1.1	3D Intelligent Positioning Key .....	85
6.2	PRESET /PATROL / PATTERN /BORDER FUNCTION.....	85
6.2.1	Preset Setup .....	86
6.2.2	Activate Preset.....	86
6.2.3	Patrol Setup .....	86
6.2.4	Activate Patrol .....	86
6.2.5	Pattern Setup.....	87
6.2.6	Activate Pattern Function.....	87
6.2.7	Border Setup.....	87
6.2.8	Activate Border Function .....	87
6.2.9	Flip .....	87
<b>7</b>	<b>WEB CLIENT OPERATION.....</b>	<b>89</b>
7.1	NETWORK CONNECTION .....	89
7.2	LOGIN.....	89
7.2.1	Real-time Monitor.....	92
7.2.2	PTZ.....	93
7.2.3	Colour.....	96
7.2.4	Picture Path and Record Path .....	96
7.2.5	Menu Interface Switch .....	97
7.3	CONFIGURE .....	98
7.3.1	System Information.....	98
7.3.2	Setting .....	100
7.4	SEARCH.....	119
7.4.1	Download .....	120
7.5	ALARM.....	121

7.6	ABOUT .....	121
7.7	LOG OUT .....	122
7.8	UN-INSTALL WEB CONTROL .....	122
<b>8</b>	<b>SIGHTBOSS SYSTEM.....</b>	<b>123</b>
8.1	FEATURES.....	123
8.2	ENVIRONMENT.....	123
8.3	OVERVIEW.....	123
8.4	MORE DETAILS.....	124
<b>9</b>	<b>FREQUENTLY ASKED QUESTIONS .....</b>	<b>125</b>
<b>10</b>	<b>RECORDING TIMES.....</b>	<b>128</b>
10.1	DAYS RECORDING PER HDD SIZE BASED ON 4 CHANNEL MACHINE	128
10.2	DAYS RECORDING PER HDD SIZE BASED ON 8 CHANNEL MACHINE.....	129
10.3	DAYS RECORDING PER HDD SIZE BASED ON 16 CHANNEL MACHINE ..	130
<b>11</b>	<b>NETWORKING A DIGITAL VIDEO RECORDER.....</b>	<b>131</b>
11.1	BASIC NETWORK TROUBLESHOOTING .....	131
11.2.1	OPTION 1 : CONNECT A DVR DIRECTLY TO A SINGLE PC .....	134
11.2.2	OPTION 2 : CONNECT A DVR TO A PC VIA A SWITCH OR HUB.....	135
11.2.3	OPTION 3 : CONNECTING FOR INTERNET ACCESS.....	136
<b>APPENDIX A</b>	<b>HDD CAPACITY CALCULATION .....</b>	<b>138</b>

## **Welcome**

Thank you for purchasing our DVR!

This operating manual is designed to be a reference tool for the installation and operation of your system.

Here you can find information about this series DVR features and functions, as well as a detailed menu tree.

Before installation and operation please read the following safeguards and warnings carefully!

## **Important Safeguards and Warnings**

### **1 Electrical safety**

The installation and operation of this DVR must conform to UK electrical safety standards. We accept no liability or responsibility for problems caused by improper handling or installation.

### **2 Transportation Security and Installation**

Ensure that during transportation and installation of this equipment that the DVR is not subject to vibration, dampness or mishandling.

### **3 Installation**

Keep upright and handle with care.

Do not apply power to the DVR before completing installation.

Do not place objects on top of the DVR or near any air vents.

### **4 Qualified engineers needed**

All examination and repair work must be undertaken by a qualified service engineer.

We are not liable for any problems caused by unauthorised modifications or repairs.

### **5 Environment**

The DVR should be installed in a cool, dry place, away from direct sunlight and any inflammable or explosive substances etc.

### **6. Accessories**

Only use accessories recommended by the manufacturer.

Before installation, please open the package and check all the components listed below are included:

- One power cable

- One Ethernet cable
- Four HDD cables
- Alarm & relay terminal blocks
- Extensional cable (for audio, loop & matrix)
- One remote control (including the battery)
- One USB mouse
- One CD (including DVR manual and Client software)
- A package of installation fittings



# 1 Features and Specifications

## 1.1 Features

This series DVR has the following features:

- H.264 compression algorithm.
- Real-time live display up to 16 cameras, up to 400fps recording for CIF, 2CIF (HD1) and up to 200 fps recording for 4CIF (D1). Note fps relates to 16 channel model.
- Pentaplex function: live, recording, playback, backup & remote access
- Intelligent search and playback support. You can playback motion detection video that occurs in an area you select.
- 8 HDDs supported and CD-RW/DVD-RW.
- Multiple control methods: front panel, IR remote control, keyboard, USB mouse and network keyboard.
- Smart video detection: motion detection, camera masking and video loss.
- Smart camera settings: privacy masking, camera lock, colour setting, and title display.
- Pan Tilt Zoom and Speed Dome Control: more than 60 protocols supported, preset, scan, auto pan, auto tour, pattern and auxiliary functions.
- Easy backup methods: USB, CD-RW/DVD-RW and network download
- Alarm triggering screen tips, buzzer, PTZ preset, e-mail, FTP upload.
- Smart HDD Management: HDD hibernation, HDD faulty alarm and Raid functionality.
- Powerful network software: built-in web server, EPSS. Networking access for remote live viewing, recording, playback, setting, system status, event log, e-mail and FTP function.
- Dual encoding stream support; flexible for network transmission.

## 1.2 Specifications

### Models

DSD400 Series            4/8/16 channel loop matrix and audio/video models

### System

Main Processor	High performance embedded microprocessor
Operating System	Embedded LINUX
System Resources	Pentaplex function: live, recording, playback, backup & remote access
User Interface	GUI, on-screen menu tips.
Control Device	Front panel, USB mouse, keyboard, IR remote control, network keyboard,.
Input Method	Numeral/Character/Denotation
System Status	HDD status, data stream statistics, log record, bios version, on-line user and etc.

### Video

Video Input	4/8/16 Channel, BNC, 1.0Vp-p, 75 $\Omega$ , looping(optional),
Video Output	2-channel TV output BNC, 1.0Vp- p, 75 $\Omega$ ,1 VGA output, matrix output (optional)
Video Standards	PAL 625Line 50f/s    NTSC 525Line 60f/s

Video Compression	H.264		
Video Resolution	Format	NTSC	PAL
	D1(4CIF)	704 * 480	704 * 576
	HD1(2CIF)	704 * 240	704 * 288
	CIF	352 * 240	352 * 288
	QCIF	176 * 120	176 * 144
Video Recording	D1/2CIF/CIF/QCIF: PAL 1f/s-25f/s NTSC 1f/s-30f/s		
Video Display Split	Full and multiple screen display, 1 / 4 / 8 / 9 / 16 (Models vary)		
Tour Display	Provided		
Image Quality	1~6 level (level 6 is the best but will use more HDD space)		
Privacy Masking	Self-defined four-sided zone for privacy masking for each camera		
Camera Lock	Camera lock facility		
Camera Adjustment	Adjust colour according to different time periods		
Video Information	Camera title, time, video loss, camera lock, motion detection and recording		
TV Output Adjustment	Adjust TV output colour & display zone		

### Audio

Audio Input	4/8/16 channel, BNC, 200-2800mV, 30K $\Omega$
bidirectional Audio Input	1-channel, RCA, 200-2800mV, 30K $\Omega$
Audio Output	1-channel, RCA, 200-3000mv, 5K $\Omega$
Audio Compression	ADPCM

### Video Detection & Alarm

Motion Detection	Zones: PAL 396 (22*18)/NTSC 330(22*15) detection zones Sensitivity: 1~6 (level 6 is highest) Trigger recording, PTZ movement, tour, alarm, e-mail & FTP
Video Loss	Trigger recording, PTZ movement, tour, alarm, e-mail & FTP
Camera masking	Trigger recording, PTZ movement, tour, alarm, e-mail & FTP
Alarm Input	4/8/16 channel, programmable, ground, manual open/closed Trigger recording, PTZ movement, tour, alarm, e-mail & FTP
Relay output	6-channel, 30VDC, 1A, NO/NC, form-C,

### Hard Disk

Hard Disk	8 SATA ports, 8 HDDs supported.
Space Occupation	Audio 14.4MB/H Video 56 700MB/H
HDD Management	Hard disk hibernation technology, HDD faulty alarm & Raid (Redundancy)

### Record, Playback & Backup

Recording Mode	Manual, continuous, video detection (including motion detection, camera masking, video loss), Alarm
Recording Priority	Manual >Alarm >Video Detection >Continuous.
Recording Interval	1 to 120 minutes (default: 60 minutes)
Overwrite Mode	Provided
Raid Function	Provided
Search Mode	Time/Date, Alarm, Motion Detection & exact search (accurate to one second)

Playback 2-channel playback simultaneously. Play, pause, stop, rewind, fast play, slow play, next file, previous file, next camera, previous camera, full screen, repeat, shuffle & backup selection.

Digital Zoom Selected zone can zoom into full screen during playback  
Backup Mode Memory stick/ USB HDD/ USB CD-RW/DVD-RW/ built-in SATA Burner/ network download

### **Network**

Interface RJ-45 Port (10/100M)  
Network Functions TCP/IP, DHCP, DDNS, PPPoE, E-mail, FTP  
Remote operation Monitor, PTZ control, playback, system setting, file download, log information

### **Auxiliary Interface**

USB Interface 2 USB 2.0 ports, 1 for mouse control, 1 for backup.  
RS232 Keyboard, PC communication  
RS485 PTZ control

### **Environmental**

Power Supply 220V 50Hz / 110V 60Hz  
Power Consumption 25W/30W/40W (4ch/8ch/16ch)  
Working Temperature 0 ~ 55  
Power Consumption 25W/30W/40W (4ch/8ch/16ch)  
Working Humidity 10%~90%  
Atmosphere Pressure 86kpa~106kpa  
Dimension 2U, 440mmx460mmx89mm (W\*D\*H)  
Weight 7.0KG  
Mounting Desktop or rack

### **Note: Comparisons**

Model	Audio Input	Loop Output	Matrix Output	Bidirectional Talk Input
DSD404	4 channel	4 channel	1 channel	1 channel
DSD408	4 channel	8 channel	1 channel	1 channel
DSD416	4 channel	16 channel	1 channel	1 channel

## 2 Overview and Controls

This section provides information about front panel and rear panel. When you install this series DVR for the first time, please refer to this part first.

### 2.1 Front Panel

This series DVR has two different front panels. You can refer to Figure 2-1 and Figure 2-2.

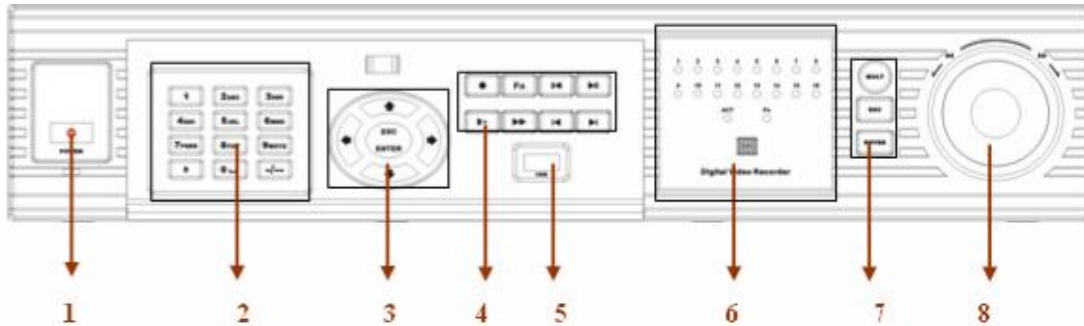

Figure 2-1

S/N	Name	Icon	Function
1	Power button	POWER	Power button, press this button for three seconds to shut down DVR.
	Power indication light		Power indication light
2	Shift	↑	In preview interface(no other menu), press this button for three seconds, you can switch between TV/VGA output (HD1 series DVR has three modes LTV/VGA/60Hz LCD)
			In textbox, click this button to switch between numerics, English upper and lower case and symbols etc.
			Open/close tour
	numeral keys 0-9	0-9	Input password, switch channel and input numerics.
Input numerals more than 10	-/--	When you need to input numerals greater than 9, click the first key number and the the next. For example, to input 123, click numeral 1, then 2 and then 3.	
3	Up/down	▲ ▼	Activate current control, modify setup, increase/decrease numerals, assistant function such as PTZ menu.
	Left/right	◀ ▶	Shift current activated control. When in playback mode, click these buttons to control playback bar.
	ESC	ESC	Close upper interface or controls.
	Enter	ENTER	confirm operation
Go to default button			

			Go to main menu
4	Record	●	Manually stop/start recording, working with direction keys or numeric keys.
	Slow play	▶	Multiple slow play speeds or normal playback
	Assistant	Fn	One-window monitor mode, click this button to display assistant function: PTZ control and image colour. In PTZ menu, shift PTZ control menu.
			Backspace function: in numeric control or text control, it can delete the previous character before the cursor.
			In motion detection setup, working with Fn and direction keys.
			In HDD information menu, switch between HDD record time or other information (Menu prompt)
			Control other special functions
	Fast play	▶▶	Various fast speeds and normal playback.
	Play previous	◀	In playback mode, playback the previous video. In menu setup, go to the upper part of the dropdown list.
	Reverse/Pause	◀	In normal playback or pause mode, click this button to reverse Playback. In reverse playback, click this button to pause playback.
Play Next	▶	In playback mode, playback the next video. In menu setup, go to bottom of the dropdown list.	
Play/Pause	▶	Reverse playback or paused mode, click this button to return to normal playback. In normal playback click this button to pause playback. In pause mode, click this button to resume playback.	
		In real-time monitor mode, click this button to enter video search menu.	
5	USB port		To connect USB storage device, USB mouse or USB CD-ROM
6	Channel indication light		When DVR is recording, this lamp turns on.
	Standby indication light		When DVR is in stand-by, this lamp turns on.
	Remote control signal receiver		To receive signals from remote control
	Function indication light		

7	Window switch	MULT	Switch between one-window and multiple-window display modes.
	Enter	ENTER	Confirm current operation
			Go to default button
			Go to main menu
Cancel	ESC	Close upper interface or controls.	
8	Shuttle (outer ring)		In real-time monitor mode it works as left/right direction key. In Playback mode, turn anti-clockwise to go forward and clockwise to go backwards.
	Jog (inner dial)		Up/down direction key. In Playback mode, turn the inner dial to select frame by frame playback. (This function only applies to some models.)

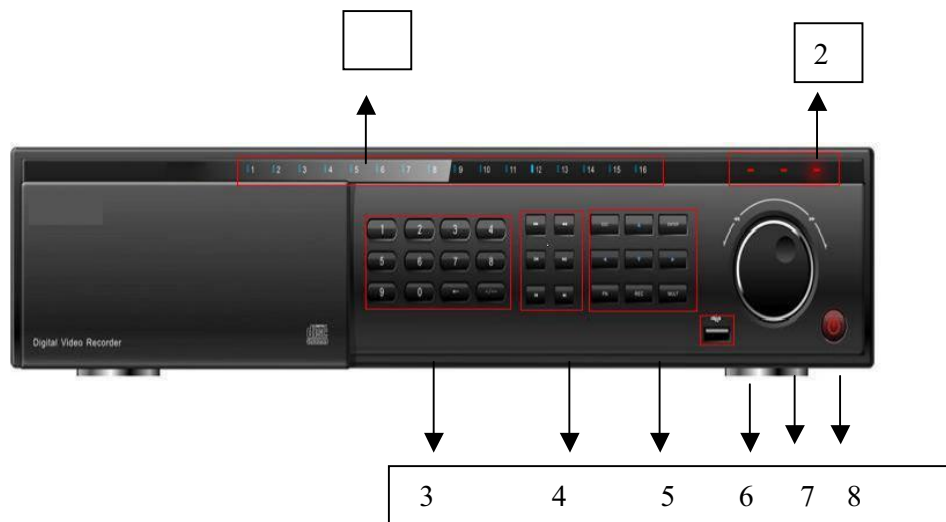











Figure 2-2

S/N	Name	Icon	Function
1	Channel indication light		When DVR is recording this lamp turns on.
2	Standby indication light		When DVR is in standby, this lamp turns on.
	Remote control signal receiver		To receive signals from remote control
3	Function indication light		
	Shift	←	In preview interface mode (no other menu), press this button for three seconds to switch between TV/VGA output. Note: HD1 series DVR has three modes: TV/VGA/60Hz LCD)

			In textbox mode, click this button to switch between numerics, alpha lower and upper case and symbols.
			Open/close tour
	numeral keys 0-9	0-9	Input password, switch channel and input numerics.
	Input numeric more than 10		When you need to input numerals more than 9 click the first key number and then the next. For example to input 123, click numeral 1, then 2 and then 3
4	Slow play		Multiple slow play speeds or normal playback
	Fast play		Various fast speeds and normal playback.
	Play previous		In playback mode, playback the previous video In menu setup, go to top of the dropdown list.
	Reverse/Pause		In normal playback or pause mode, click this button to reverse playback. In reverse playback, click this button to pause playback.
	Play Next		In playback mode, playback the next video. In menu setup, go to bottom of the dropdown list.
	Play/Pause		Reverse playback or pause mode, click this button to return to normal playback. In normal playback mode click this button to pause playback. In pause mode, click this button to resume playback. In real-time monitor mode, click this button to enter video search menu
5	Up/down		Activate current control, modify setup, increase/decrease numerals and use in assistant function such as PTZ menu.
	Left/right		Shift current activated control. When in playback, click these buttons to control playback bar.
	Cancel	ESC	Close upper interface or controls.
	Enter	ENTER	Confirm operation
			Go to default button
			Go to main menu
	Record		Manually stop/start recording, working with direction keys or numeric keys.
Window switch	MULT	Switch between one-window and multiple-window display modes.	
Assistant	Fn	One-window monitor mode, click this button to display assistant function: PTZ control and image colour. In PTZ menu, shift PTZ control menu.	

			Backspace function: in numeral control or text control, it can delete the previous character before the cursor.
			In motion detection setup, working with Fn and direction keys.
			In HDD information menu, switch between HDD record time or other information (Menu prompt).
			Control other special functions
6	USB port		. To connect USB storage device, USB mouse or USB CD-ROM
7	Shuttle (outer ring)		In real-time monitor mode it works as left/right direction key. In Playback mode, anti- clockwise to go forward and clockwise to go backward
	Jog(inner dial)		Up/down direction key. Playback mode, turn the inner dial to select frame by frame playback. (Only applies to some DVR models.)
8	Power button	POWER	Power button, press this button for three seconds to shut down DVR.
	Power indication light		Power indication light

**Note:**

Turn shuttle (outer ring) clockwise stands for right, counter clockwise stands for left.

Turn jog (Inner dial) clockwise stands for down, anti-clockwise stands for up.

## **2.2 Rear Panel**

### **2.2.1 Overview**

Please refer to Figure 2-3 for information.



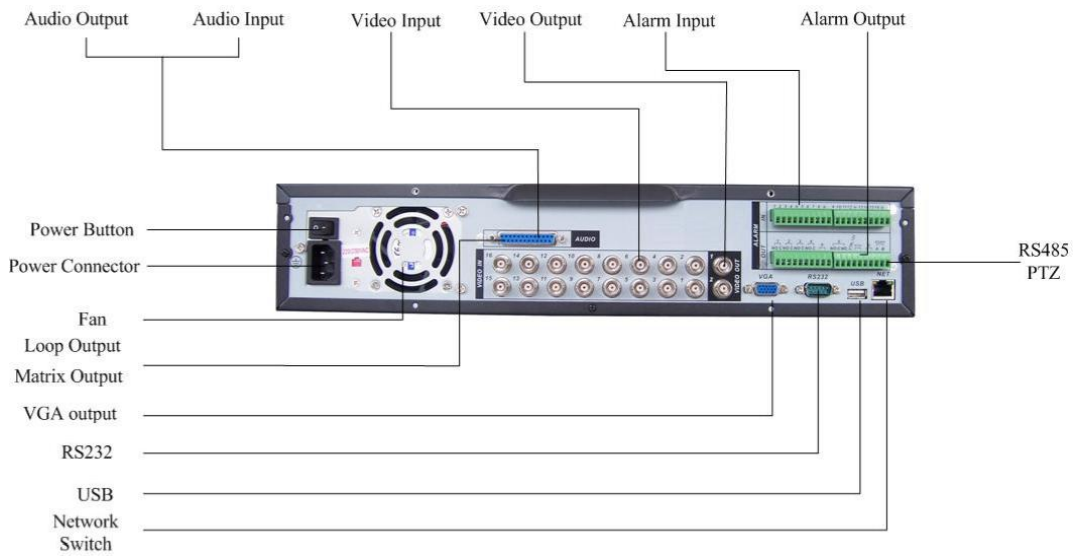

Figure 2-3

### 2.2.2 Connection Sample

Here is a connection sample for your reference. See Figure 2-4.

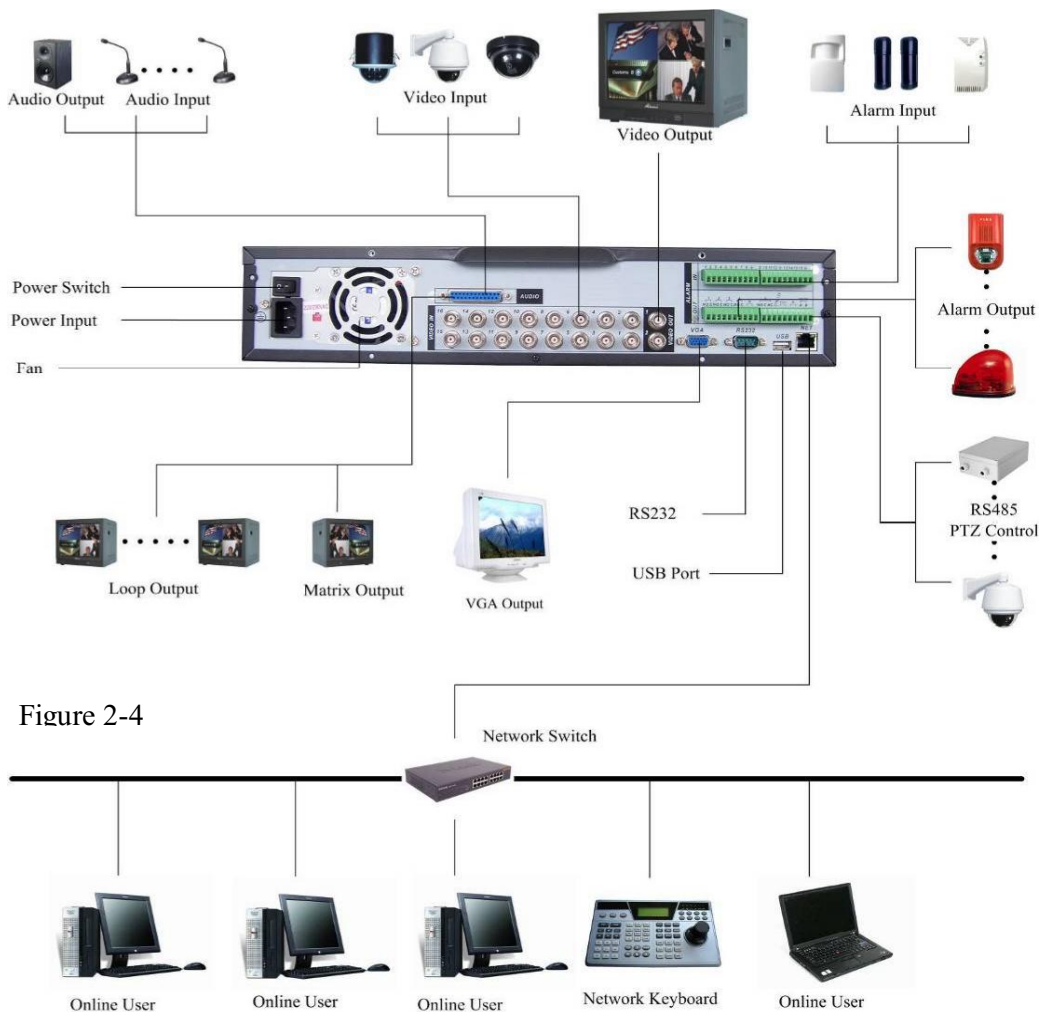

Figure 2-4

## 2.3 Remote Control

The remote control interface is shown as in Figure 2-5.

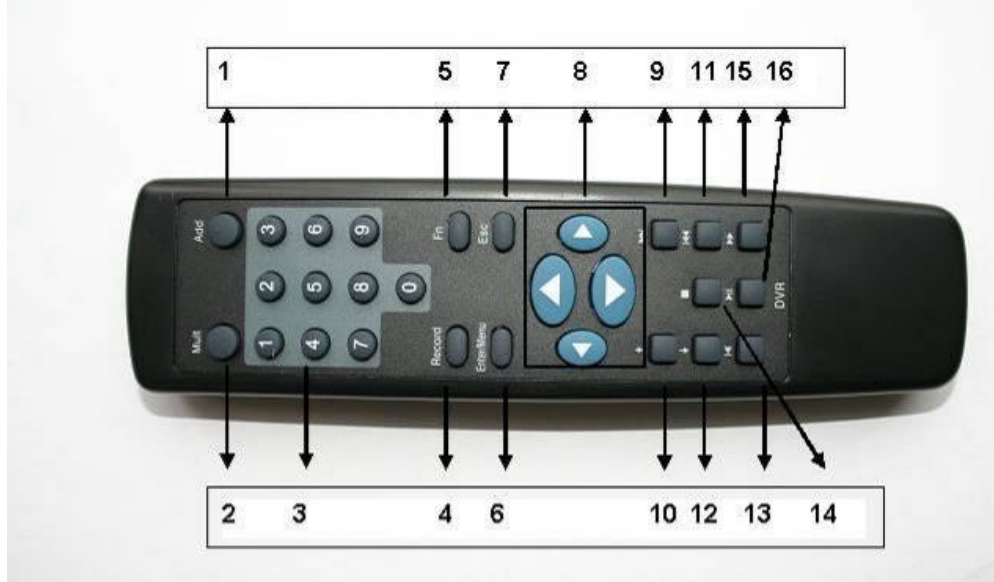
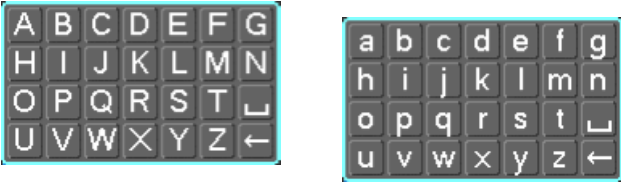



Figure 2-5

Serial Number	Function
1	Remote switch
2	Multiple-window switch
3	0-9 number key
4	Record
5	Auxiliary key
6	Confirm /menu key
7	Cancel
8	Direction key
9	Forward
10	Previous
11	Back
12	Next
13	Slow play
14	Stop
15	Fast play
16	Play/Pause

## 2.4 Mouse Control

Left click mouse	System displays password input box if you have not logged in.
	In real-time monitor mode, you can go to the main menu.
	When you have selected one menu item, left click mouse to view menu content.
	Implement the control operation.
	Modify checkbox or motion detection status.
	Click combo box to display drop down list

	<p>In the input box you can select various input methods. If you left click the corresponding button on the panel you can input numerals, upper and lower case letters or symbols. The arrow ← stands for backspace button and the underline stands for the space button.</p> <p><b>In text mode:</b> The _ stands for inputting a backspace and the ← stands for deleting the previous character.</p>  <p><b>In numeral input mode:</b> The _ stands for clear and the ← stands for deleting the previous numeral.</p> <p>When inputting a special symbol, you can click corresponding numeral in the front panel to input. For example, click numeral 1 you can input“/” , or you can click the numeral in the on-screen keyboard directly.</p> 
<p>Double left mouse click</p>	<p>Implement special control operation such as double click one item in the file list to playback the video.</p> <p>In multiple-window mode, double left click one channel to view in full-window.</p> <p>Double left click current video again to go back to previous multiple-window mode.</p>
<p>Right click mouse</p>	<p>In real-time monitor mode, the shortcut menu is displayed: One-window, Four-windows, Nine-windows and Sixteen-windows, Pan/Tilt/Zoom, Colour setting, Search, Record, Alarm output, Alarm input and Main menu.</p> <p>The Pan/Tilt/Zoom and Colour setting applies for current selected channel.</p> <p>If you are in multiple-window mode, system automatically switches to the corresponding channel.</p> 
	<p>Exit current menu without saving the modification.</p>

Press middle button	In numeral input box: Increase or decrease numeral value.
	Switch the items in the check box.
	Page up or page down
Move mouse	Select current control or move control
Drag mouse	Select motion detection zone
	Select privacy mask zone.

## 2.5 Virtual Keyboard and Front Panel

### 2.5.1 Virtual Keyboard

The system supports two input methods: numeral input and upper and lower case letter input. Move the cursor to the text column. The text is shown as blue and input button is displayed to the right. Click that button to switch between numeral input and upper/lower case letters. Use > or < to shift between lower and upper case characters.

### 2.5.2 Front Panel

Move the cursor to the text column. Click Fn key and use direction keys to select number you want. Please click enter button to input.

## 3 Installation and Connections

### 3.1 Check Unpacked DVR

Please ensure the DVR is unpacked and complete on receipt and that there is no visible damage. The carriers will not accept responsibility for any damage unless reported within 24 hours of receipt and accompanied by the delivery reference number. Note that when receiving damaged goods the customer should sign the carrier's delivery note as "Damaged" or "Not Checked" if not checked immediately.

### 3.2 HDD Installation

#### 3.2.1 Choose Serial HDDs

We recommend Seagate HDD of 7200rpm or higher.

#### 3.2.2 Calculate HDD Size

This series have no limit to HDD capacity. You can use 120Gb -750Gb HDD to guarantee higher stability.

The formula for calculating total HDD size is:

Total Capacity (Mb) = Camera Amount \* Recording Hours \* HDD Usage Per Hour (M/h)  
H.264 compression is ideal for standalone DVRs. It can save more than 30% HDD capacity than standard MPEG4. When you calculate the total HD capacity, you should estimate the average HDD capacity per hour for each channel.

For example, for a 4-ch DVR, the average capacity of HDD usage per hour per channel is 200M/h. If the DVR records video for 12 hours each day for 30 days, the total capacity of HDDs required for 4 channels will be 4 channels \* 30 days \* 12 hours \* 200 M/h = 288Gb. So you need to install one 300Gb HDD or 2 x 160Gb HDDs.

#### 3.2.3 HDD Installation

Data ribbons, fastening screws and smart HDD shelf design are already provided in the accessories.

Please follow the instructions below to install hard disk.



1. Loosen the screws of the upper cover.



2. Remove the HDD bracket from internal unit.



3. Dismantle the upper HDD bracket.



4. Install the HDD. Note the HDD is placed upside down.

Please make sure bracket is in correct position.

**If you are fitting less than 4 x HDDs you do not need to install the HDD bracket.**



5. Screw the two bracket parts together.



6. Put HDD bracket back and then fix firmly.



7. Loosen the power cable.



8. Connect to the SATA ports and then connect power cord to the HDDs.



9. Place the upper cover back and screw firmly.

After HDD installation, please check connection of data ribbon and power cord.

### 3.3 CD/DVD Burner Installation

For built-in burner, you can dismantle front plate to install CD burner. This built-in burner should be set as MASTER.

For USB burners, you need to install a USB serial burner.

## **3.4 Desktop and Rack Mounting**

### **3.4.1 Desktop Mounting**

To prevent surface damage, please make sure that the rubber feet are securely installed on the four corners of the bottom of the unit.

Position the unit to allow for cable and power cord clearance at the rear of the unit. Be sure that the air flow around the unit is not obstructed.

### **3.4.2 Rack Mounting**

The DVR occupies two rack units of vertical rack space.

The hardware necessary to mount the DVR into a rack is supplied with the unit.

Rear doors may be used only on rack columns that are more than 26 inches (66.0 cm) deep.

Install the cabinet in a ventilated place. Avoid extreme heat, humid or dusty conditions. You should regularly use a soft dry brush to clean opening outlet and cooling fan etc.

## **3.5 Connecting Power Supply**

Please check that input voltage and device power button match.

We recommend you use a UPS to guarantee stable operation, DVR life span and support other peripheral equipment such as cameras.

## **3.6 Connecting Video Input and Output Devices**

### **3.6.1 Connecting Video Input**

The DVR automatically detects the video standard (PAL or NTSC) whenever you connect a video input. It accepts both colour and black-and-white, and analog video.

NOTE:

- Enabling line lock on cameras may cause video distortion. There may be noise in the camera's power source. If video from one or more cameras is distorted, we recommend you disable line lock on the camera as your first troubleshooting step.
- If a video distribution amplifier is installed between the video source and the DVR, do not set the output video level above 1 Vp-p.

To connect each video input:

1. Connect a coaxial cable to the camera or other analog video source.
2. Connect the coaxial cable to the video in connector on the rear panel.

Please refer to Figure 3-1 for more information.

**NOTE:**

You need to use a BNC installation tool to connect coaxial cables to the rear panel.



Figure 3-1

### 3.6.2 Connecting Video Output

This section provides information about physically connecting video display devices to the DVR. See Figure 3-2.

If you connect the DVR with a TV monitor or VGA monitor, the DVR can automatically detect the monitor type. Without any output device, by default, the DVR is configured to use a TV monitor. In this case, if your application requires a VGA monitor, you have to press the button “FN” or Shift on the front panel.

**NOTE:**

Video output 1 and VGA can't display at the same time. But Video output 2 can display properly with Video Output 1 or VGA.

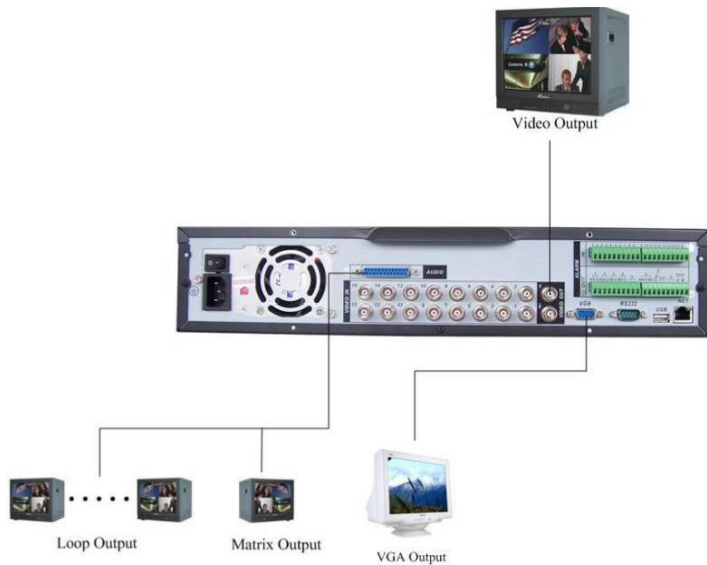

Figure 3-2



### 3.7 Connecting Audio Input/Output & Loopthrough

For the 25-pin or 37-pin interface, different models include different functions. For example, the DSD316 has 16 audio inputs, 1 audio output and a bidirectional audio input. See Figure 3-3.

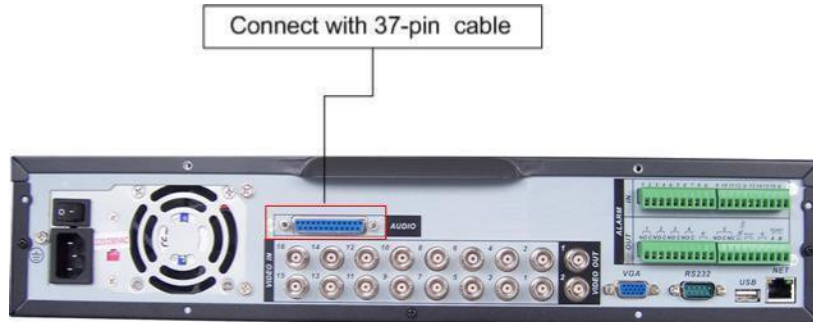

Figure 3-3

#### 3.7.1 Audio Input/One Audio Output

The DSD316M has 16 looping video inputs, 1 matrix video output, 4 audio inputs, a bidirectional audio input and 1 audio output.

##### Audio input, bidirectional audio input and audio output

The DVR encodes audio and video signals simultaneously, which lets you control audio at the monitored location.

##### To set up audio:

1. Make sure your audio input device matches the RCA input level. If the device and RCA input levels do not match, audio distortion problems may occur.
2. Make sure the audio connector is wired as follows:

Connect a line input device or pre-amplified microphone to the audio connector for the video channel on the rear panel.

Please refer to .

Figure 3-4.

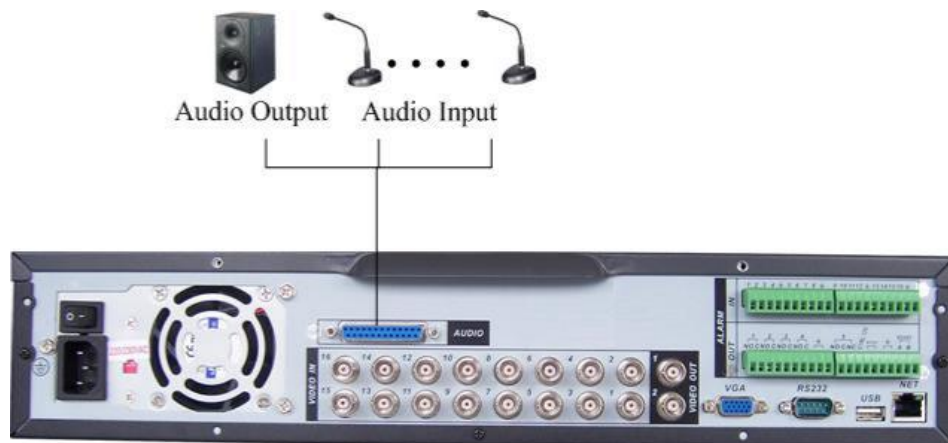

Figure 3-4

### 3.7.2 Looping video

The DVR supports looping video. It passes the video input to a monitor or other analog video device.

#### To use looping video:

1. Connect a coaxial cable to the video out connector on 37-pin interface.  
Please note you need to use a BNC connection on coaxial cables to the rear panel.
2. Connect the other end of the coaxial cable to the analog device.

### 3.7.3 Matrix Video Output (optional)

Use video matrix output connector during installation to display video sequentially from each video input. The unit displays each channel for selected seconds. You can use this feature to verify camera installation.

To display video from each connected video source:

1. Connect a video monitor to the video matrix output connector.
2. Turn the DVR on, the monitor, and each video matrix output source.
3. Verify the video from each source and troubleshoot as necessary.

Please refer to Figure 3-5.

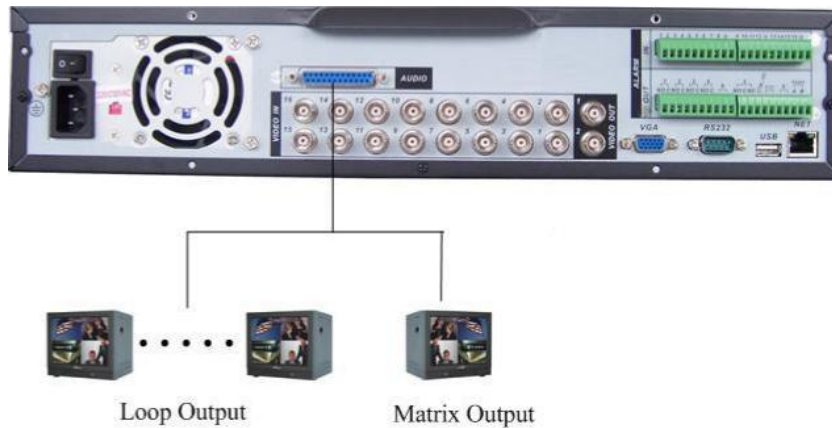

Figure 3-5

### 3.7.4 Alarm Input and Relay Output

The DVR offers 16 alarm inputs for external signaling devices, such as door contacts or motion detectors. Each alarm input can be either normally open or normally closed. Once configured, an alarm input can invoke many different activities, including triggering a relay device, sending an alert to a security office or storing pre-alarm video to the DVR.

### 3.7.5 Alarm Input

You should check whether your alarm input mode is a grounding alarm input or not.

For this series DVR, grounding signal is needed for alarm input.

If you need to connect two units or one DVR and other device, please use relay to separate them.

Please refer to Figure 3-6 for more information.



Figure 3-6

### 3.7.6 Alarm Output

Do not connect alarm output port directly to a high power load (no more than 1 A). You can use the lower green terminal block to make the connection between the alarm output port and the load.

Please refer to Figure 3-7 for more information.

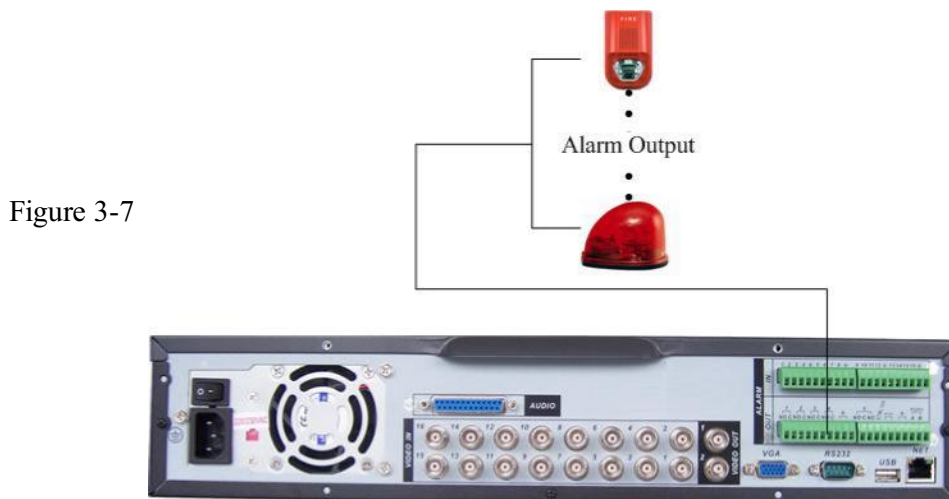

Figure 3-7

### 3.7.7 Alarm Input and Output Details

You can refer to the following sheet and Figure 3-8 for alarm input and output information.

Parameter	Grounding Alarm
Ground	Ground line
Alarm Input	1, 2, ..., 16
Relay Output	1,2,3,4: NO and C(Normally Open and Com) 5: NO,C and NC(Normally Open, Com, Normally Closed) 6: Ctrl 12V(This is used to reset the sensor)
485 A B	RS485 communication port. They are used to control devices such as PTZ.
+12 C	This should input an external power input.

- 4/8/16-ch grounding alarm inputs. (Normal open or Normal close type)
- Please parallel connect COM end and GND end of the alarm detector (Provide external power to the alarm detector).
- Please parallel connect the Ground of the DVR and the ground of the alarm detector.
- Please connect the NC port of the alarm sensor to the DVR alarm input (ALARM)
- If you need to reset the triggered alarm remotely, you can use DVR to supply controllable 12 V power to the alarm detector such as the smoke detector.
- Use the same ground with that of DVR if you use external power to the alarm device.

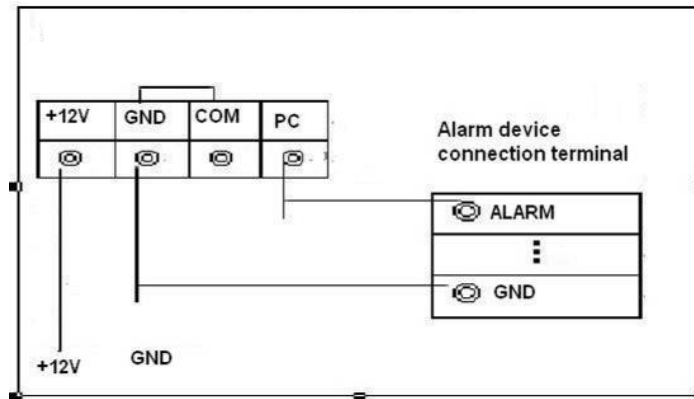

Figure 3-8

### 3.7.8 Relay Output Description

- 6 way relay alarm output. Provide external power to external alarm device.
- To avoid over loading, please read the following relay parameter sheet carefully. (See below table)
- The controllable +12v can be used to restore the smoke detector.

Please refer to Figure 3-9 for alarm input module information.

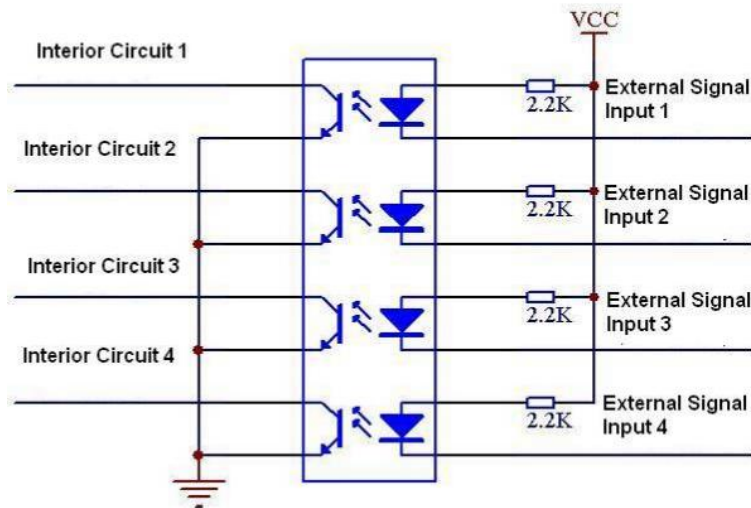

Figure 3-9

Please refer to Figure 3-10 for alarm output module information.

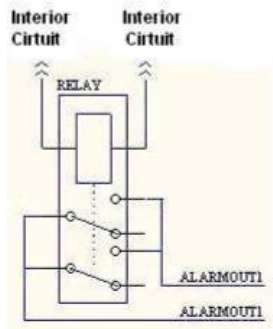

Figure 3-10

### Relay Specification

<b>Model:</b>	<b>JRC-27F</b>	
Relay contacts	Silver	
Rating resistance load	Rated switch capacity	30VDC 2A, 125VAC 1A
	Maximum switch power	125VA 160W
	Maximum switch voltage	250VAC, 220VDC
	Maximum switch current	1A
Insulation	between contacts with same polarity	1000VAC 1minute 50/60Hz
	between contacts with different polarity	1000VAC 1minute 50/60Hz
	between contact and winding	1000VAC 1minute 50/60Hz
Surge voltage	between contacts with same polarity	1500V (10×160us)
Length of open time	3ms max	
Length of close time	3ms max	
Longevity	Mechanical	50×10 <sup>6</sup> times (3Hz)
	Electrical	200×10 <sup>3</sup> times (0.5Hz)
Temperature	-40 ~+70	

### 3.8 RS232

You can connect the DVR with POS or Keyboard through RS232.

With POS system, the DVR can communicate through RS232 and network. For the POS system, the DVR can integrate the text content and even search the record through the info. This series DVR also support NKB operation. You can operate the DVR from the keyboard controls instead of using the control pad on the front panel of the unit.

To connect a NKB keyboard to the DVR:

1. Assemble the KBD keyboard according to the instructions in its accompanying installation manual.
2. Connect the KBD keyboard into one of the RS232 ports on the DVR or through network.

### 3.9 RS485

When the DVR receives a camera control command, it transmits that command up the coaxial cable to the PTZ device. RS485 is a single-direction protocol; the PTZ device can't return any data to the unit. To enable the operation, connect the PTZ device to the RS485(A,B) input on the DVR. Since RS485 is disabled by default for each camera, you must enable the PTZ settings first. This series DVR supports multiple protocols such as Pelco-D, Pelco-P etc.

#### Connecting PTZ devices to the DVR:

1. Connect RS485 A,B on the DVR rear panel.
2. Connect the other end of the cable to the RS485 connections on the camera.
3. Follow the instructions for configuring a camera to enable each PTZ device on the DVR.

### 3.10 Other Interfaces

There are other interfaces on the DVR, such as USB ports. Refer to Figure 3-11 for more information.

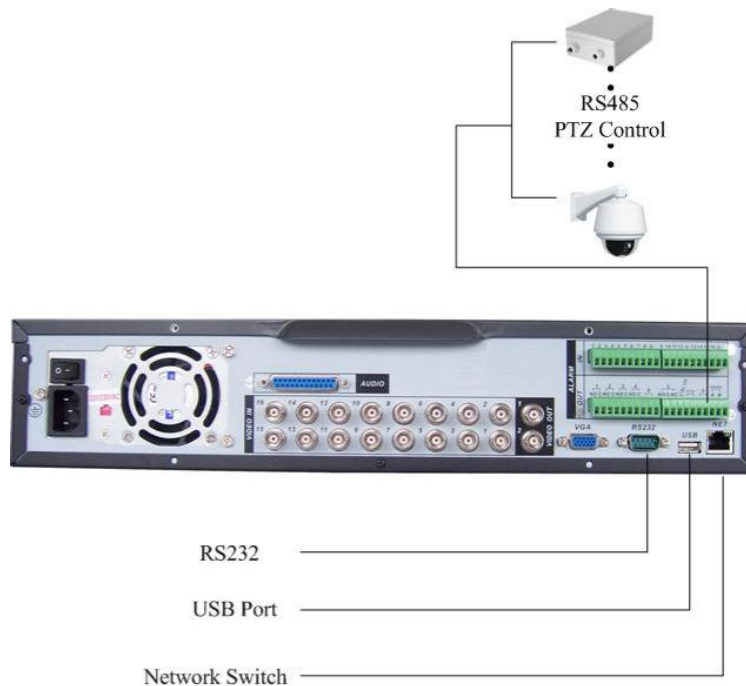

Figure 3-11

## 4 Overview of Navigation and Controls

Before operation, please make sure you have properly installed HDDs and all the cable connections.

### 4.1 Login, Logout & Main Menu

#### 4.1.1 Login

When the system boots up, default video display is in multiple-window mode.

Click Enter or left click mouse, you can see the login interface. See Figure 4-1.

System consists of four accounts:

- Username: admin. Password: admin. (administrator, local and network)
- Username: 888888. Password: 888888. (administrator, local only)
- Username: 666666. Passwords: 666666 (Lower authority user who can only monitor, playback, backup and etc.)
- Username: default. Password: default (hidden user)

For your system security, please modify you password after first login.

You can use USB mouse, front panel, remote controller or keyboard to input. About input method: Click  to switch between numerics, upper and lower case alpha and symbols.

#### Note:

If more than three login failure attempts occur within 30 minutes the DVR will alarm and if more than five failure attempts occur, this will result in an account lock. To release reboot the DVR or wait 30 minutes to clear.



Figure 4-1

#### 4.1.2 Main Menu

After you log in, the system main menu is displayed. See Figure 4-2.

There are a total of six icons: Search, Information, Setting, Backup, Advanced and Shutdown. If you move the cursor to highlight the icon you then double click mouse to enter the sub-menu.

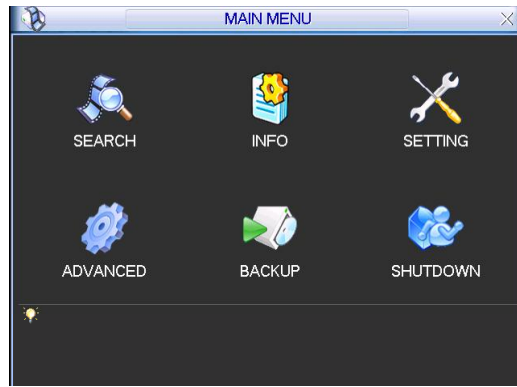

Figure 4-2

### 4.1.3 Logout

There are two ways for you to log out.

One is from menu option:

In the main menu, click shutdown button, you will see the interface shown below. See Figure 4-3.

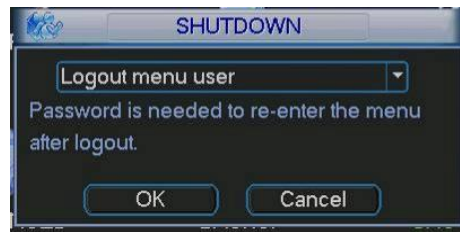

Figure 4-3

There are several options available. See Figure 4-4.



Figure 4-4

The other option is to press the power button on the **front** panel for at least 3 seconds and system will stop all operations. Then you can click the power button in the rear panel to turn off the DVR.

### 4.1.4 Auto Resume after Power Failure

The system can automatically backup video and resume previous working status after power failure.

### 4.1.5 Replace Button Battery (If DVR loses time or will not display correct date/time)





Please make sure to use the same battery model if possible. We recommend replacing battery regularly to guarantee system time accuracy. If DVR is not connected to power for long periods this will quickly drain button battery.





## 4.2 Recording Operation

### 4.2.1 Live Viewing

When you login, the system is in live viewing mode. You can see system date, time and channel name. If you want to change system date and time, you can refer to general settings (Main Menu->Setting->General). If you want to modify the channel name, please refer to the display settings (Main Menu->Setting->Display)

1		Recording status	3		Video loss
2		Motion detection	4		Camera lock

Note: Please refer to the following sheet for channel status.  stands for opening switch function,  stands for closing switch function.

### 4.2.2 Manual record

#### Note:

You need to have proper rights to implement the following operations. Please make sure the HDDs have been properly installed.

#### 4.2.2.1 Manual record menu

There are two ways for you to go to the manual record menu.

- Right click mouse or in the main menu, Advanced->Manual Record.
- In live viewing mode, click record button in the front panel or record button in the remote control.

Manual record menu is shown as in Figure 4-5.

#### 4.2.2.2 Basic operation

There are three statuses: schedule/manual/stop. Highlight icon “○” to select corresponding channel.

- Manual: the highest priority. After manual setup, all selected channels will begin ordinary recording.
- Schedule: channel records as you have set in recording setup (Main Menu->Setting->Schedule)
- Stop: all channels stop recording.



Figure 4-5

#### 4.2.2.3 Enable/disable record

Please check current channel status: “○” means it is in recording status,

“●” means it is not in recording status.

You can use mouse or direction key to highlight channel number. See Figure 4-6.



Figure 4-6

#### 4.2.2.4 Enable all channel recording

Highlight  below **All** to enable all channel recording.

#### **All channel Schedule record**

Please highlight “ALL” after “Schedule”. See Figure 4-7.

When system is in schedule recording, all channels will record as you have previously set (Main menu->Setting->Schedule).

The corresponding indication light in front panel will turn on.

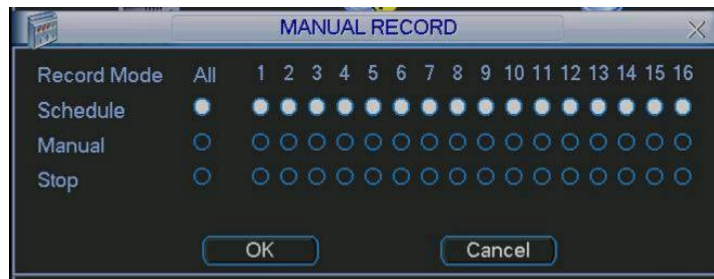

Figure 4-7

#### **All channel Manual record**

Please highlight “ALL” after “Manual.” See Figure 4-8.

When system is in manual recording, all scheduled set up you have set will be deleted. ((Main menu->Setting->Schedule)).

You will see indication lights on front panel turn on and system begins manual recording.

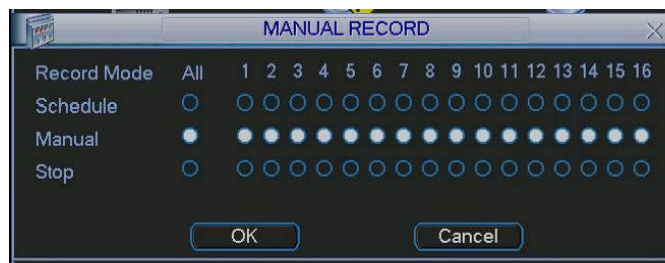

Figure 4-8

#### 4.2.2.5 Stop all channel recording

Please highlight “ALL” after “Stop”. See Figure 4-9.

System stops all channel recording no matter what mode you have set in the menu (Main menu->Setting->Schedule)



Figure 4-9

### 4.3 Search & Playback

#### 4.3.1 Search Menu

There are two ways for you to go to search menu.

- Click Pause/Play button in the remote control.
- Click search in the main menu.

Search interface is shown as below. See Figure 4-10.

Usually there are three file types:

- R: regular recording file.
- A: external alarm recording file.
- M: motion detection recording file
- C: card and pos test overlay recording file (For special series only)

There are several playback windows. System supports 1/2-ch playback.

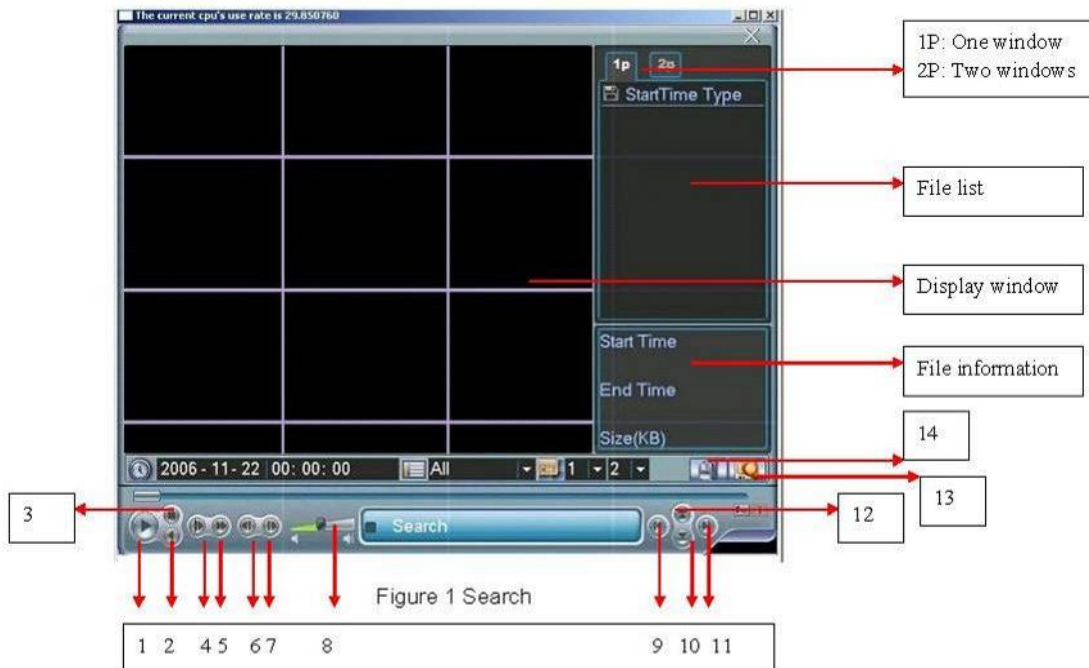

Figure 4-10

Please refer to the following sheet for more information.

Reference Number	Function
1	Play
2	Backward
3	Stop
4	Slow play
5	Fast play
6	Previous frame
7	Next frame
8	Volume
9	Previous file
10	Next channel
11	Next file
12	Previous channel
13	Search
14	Backup

This DVR supports 2-channel simultaneous playback.

### **4.3.2 Basic Operation**

#### **4.3.2.1 Playback**

There are various search modes: video type, channel number or time. The system can display 128 files on one screen. You can use page up/down button to view if there is more than one page. Select the file name and double click mouse (or click enter button) to view file content.

#### **4.3.2.2 Accurate playback**

Input time (h/m/s) in the time column and then click playback button.

#### **4.3.2.3 Synchronized playback function when playback**

During the playback process, click channel number using numeric key to switch to the corresponding video channel at the same time.

#### **4.3.2.4 Digital zoom**

When the system is in full-screen playback mode, drag your mouse on the screen to select a section and then left click mouse to select digital zoom. You can right click mouse to exit.

#### **4.3.2.5 File backup**

System supports backup operation during search. Just enter a √ before file name (multiple choices) and then click the backup button (Button 14 in Figure 4-10).

#### **4.3.2.6 Slow playback and fast playback**

Please refer to the following sheet for slow play and fast playback function.

<b>Button</b>	<b>Illustration</b>	<b>Remarks</b>
Fast play button ►►	In playback mode, click this button to switch between various fast play modes such as fast play 1, fast play 2 and more. (Fast play 1 means fast play level 1 and is not speed related)	Frame rate may vary due to different versions.
Slow play button ► (Or you can turn the outer ring jog counter clockwise.)	In playback mode, click this button to switch between various slow play modes such as slow play 1 or slow play 2.	
3 Play/Pause ►	In slow playback mode, click this button to switch between play/pause modes.	
4 Previous/next	In playback mode, you can click ◀ and ▶   to view previous or next video in current channel.	

#### 4.3.2.7 Fast forward/fast backward and frame by frame playback

<b>Special Functions of Shuttle and Jog</b>	<b>Illustration</b>	<b>Remarks</b>
Fast forward (outer ring jog clockwise)	When in playback, turn the shuttle (outer ring) clockwise one turn: you can view in fast level 1 Turn it twice you get fast level 2. You can continue turning to get different speeds.	In forward or backward mode, double click Pause/Play button to get normal playback.  Frame rate may vary due to different version.
Fast backward (outer ring counter jog clockwise)	When in playback, turn the shuttle (outer ring) anti clock-wise one turn, to view in backward level 1. Turn it twice to get backward level 2. You can continue turning to get different speeds.	
Manual playback frame by frame	In playback mode, click play/pause button, slowly turn the jog (inner dial) clock-wise to view frame by frame, counter clock wise to view 1 frame playback.	

#### 4.3.2.8 Backward playback and frame by frame playback

Button	Illustration	Remarks
Backward play ⏮ in playback interface.	In normal playback mode, left click backward play button, system begins backward playback. Double click backward play button again, system goes to pause mode.	When system is in backward play or frame by frame playback mode, you can click play button to go to normal playback.
Manual playback frame by frame.	Click pause button in normal playback mode and slowly turn the jog (inner dial) clockwise to view frame by frame or anti clockwise to view I frame playback.	

Note:

All the operations here (such as playback speed, channel, time and progress) are related to hardware version. Note that some series DVRs do not support some functions or playback speeds.

#### 4.3.3 Calendar

Click calendar icon  in Figure 4-10, and the system displays a calendar for your reference. Highlighted dates mean that there are recorded files for that day. You can click blue dates to view file lists. In Figure 4-11, there are video files for March 13th and 14th. Double click the dates to view file lists.

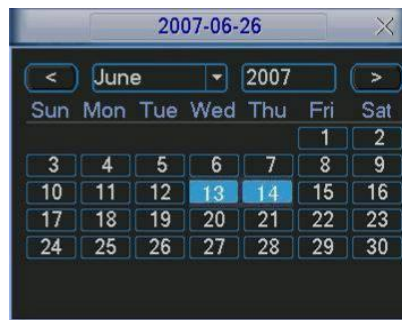

Figure 4-11

### 4.4 Record Setup (Schedule)

When the system boots up, it is in default 24-hour regular mode. You can set record type and time in schedule interface.

#### 4.4.1 Schedule Menu

In the main menu, from setting to schedule, you can go to schedule menu. See Figure 4-12.

There are three record types: R-Regular, MD-Motion detection, A- Alarm.

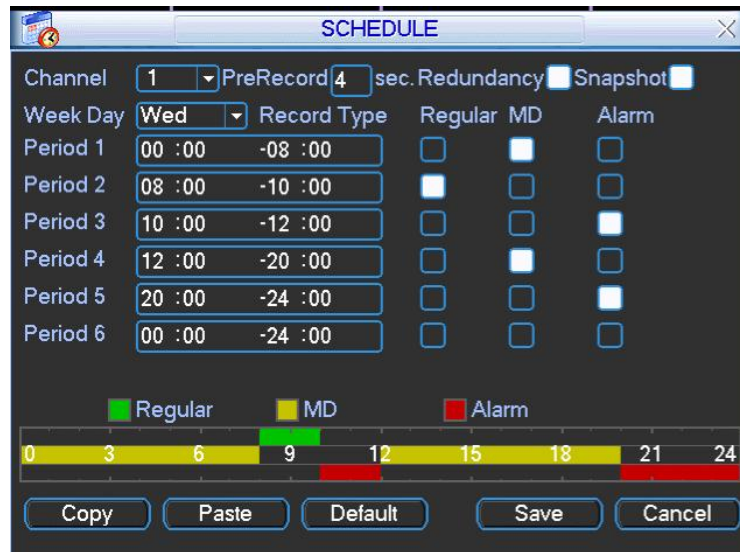

Figure 4-12

#### 4.4.2 Basic Operation

There are total six periods. See Figure 4-12.

- Channel: Please select the channel number first. You can select “all” if you want to set all channels.
- Week day: There are eight options: ranges from Saturday to Sunday and All.
- Redundancy: System supports redundancy backup function. You can highlight Redundancy button to activate this function. Please note, before enabling this function, please set at least one HDD as redundant.(Main menu->Advanced->HDD Management)
- Snapshot: You can enable this function to snapshot image when alarm occurs.
- Record types: There are three types: regular, motion detection (MD) and Alarm.

Please highlight icon  to select the corresponding function. After setup please click save button and system then returns to the previous menu.

At the bottom of the menu, there are colour bars for your reference. Green stands for regular recording, yellow stands for motion detection and red stands for alarm recording.

##### 4.4.2.1 Quick Setup

This function allows you to copy one channel setup to another. After setting channel 1, you can click copy button and then turn to channel 2 and then click paste button. You can finish settings for one channel and then click the save button or you can finish all setup and then click save button.

##### 4.4.2.2 Redundancy

Redundancy function allows you to copy recorded files on other disk drives. These files are created, packaged and closed simultaneously. When there is file damage on one disk, you can access the other disk. You can use this function to maintain data reliability and safety. In the main menu, from Setting to Schedule, you can highlight redundancy button to enable this function. See Figure 4-12.

In the main menu, from Advanced to HDD management, you can set one or more disk(s) as redundant. You can select from the dropdown list. See Figure 4-13. System auto overwrites old files once hard disk is full.

Please note only read/write disk or read-only disk can backup file and support file search function, so you need to set at least one read-write disk otherwise you cannot record video.

**Note**

**About redundancy setup:**

- If current channel is not recording, current setup gets activated when the channel begins recording the next time.
- If current channel is recording now, the redundancy setup will get activated right away so the current file will be closed and a new file opened on each hard drive media.

After setup complete please click the save button and system will return to the previous menu.



Figure 4-13

**Playback or search on the Redundant disk.**

There are two ways for you to playback or search on the Redundant disk.

- Set redundant disk(s) as read-only disk or read-write disk (Main menu->Advanced->HDD management). See Figure 4-13. System needs to reboot to get setup activated. Now you can search or playback file in redundant disk.
- Dismantle the disk and play it in another PC.

**4.5 Detect**

**4.5.1 Go to Detect Menu**

In the main menu, from Setting to Detect, you can see motion detect interface. See Figure 4-14. There are three detection types: motion detection, video loss, camera masking.

**4.5.2 Motion Detect**

Detection menu is shown as below. See Figure 4-14.

- Channel: select the channel you want to implement motion detection.
- Event type: from the dropdown list you can select motion detection type.



- Channel: select the channel to activate recording function once alarm occurred. Please make sure you have set MD record in encode interface (Main Menu->Setting->Schedule) and schedule record in manual record interface (Main Menu->Advanced->Manual Record)
- Latch: when motion detection completes, system continues motion detecting for a specified time. The value ranges from 10-300 seconds.
- Region: Click select button and the interface is shown in Figure 4-15. Here you can set a motion detection zone. There are 396(PAL)/330(NTSC) small zones.
- Sensitivity: System supports 6 levels. The sixth level has the highest sensitivity.
- Show message: System can display alarm messages on the local host screen if you enabled this function.
- Send email: System can send out email to alert you when alarm occurs.
- PTZ activation: Here you can set PTZ movement when alarm occurs. Such as go to preset, tour or pattern when there is an alarm. Click “select” button and the display interface is shown as in Figure 4-16.
- Period: Click set button and you will see an interface shown in Figure 4-17. Here you can set business day or non-business day. In Figure 4-17, click set button, you can see an interface is shown as in Figure 4-18. Here you can set your own business day or non-business day.
- Anti-dither: Here you can set anti-dither time.
- Sensitivity: There are six levels. The sixth level has the highest sensitivity.
- Alarm output: When alarm occurs, system enables peripheral alarm devices.
- Tour: Here you can enable tour function when alarm occurs. It is a one-window tour. Please go to chapter 5.3.9 Display for tour interval setup.
- Snapshot: System can snapshot when alarm occurs.

Please highlight icon  to select the corresponding function. After setup click save button and system goes back to the previous menu.

Note:

In motion detection mode, you cannot use copy/paste to set channel setup since the video in each channel may not be the same.

In Figure 4-15, you can left click mouse and then drag it to set a region for motion detection. Click Fn to switch between arm/withdraw motion detection. After setting, click enter button to exit.

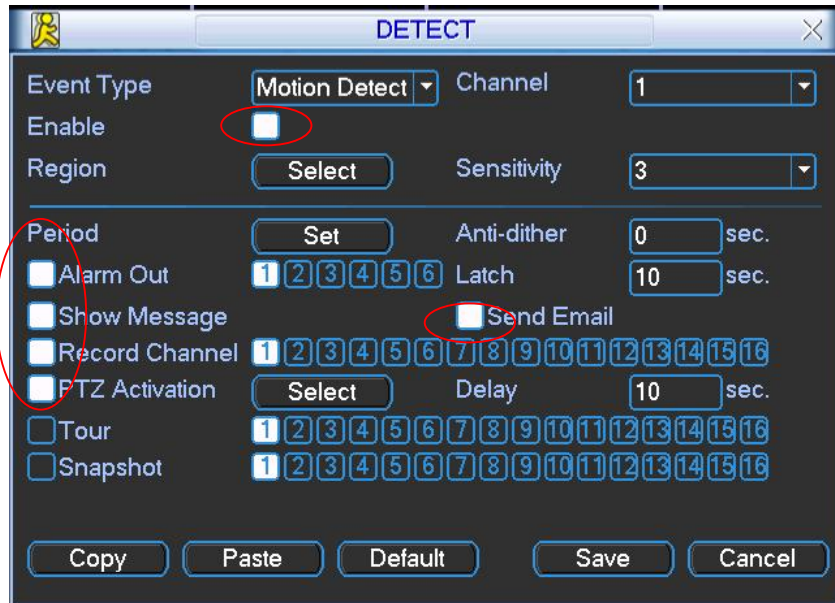

Figure 4-14

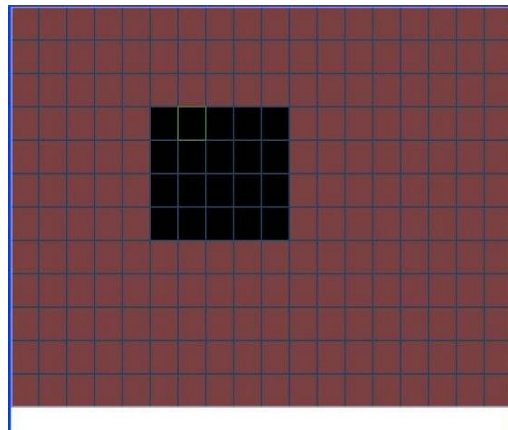

Figure 4-15

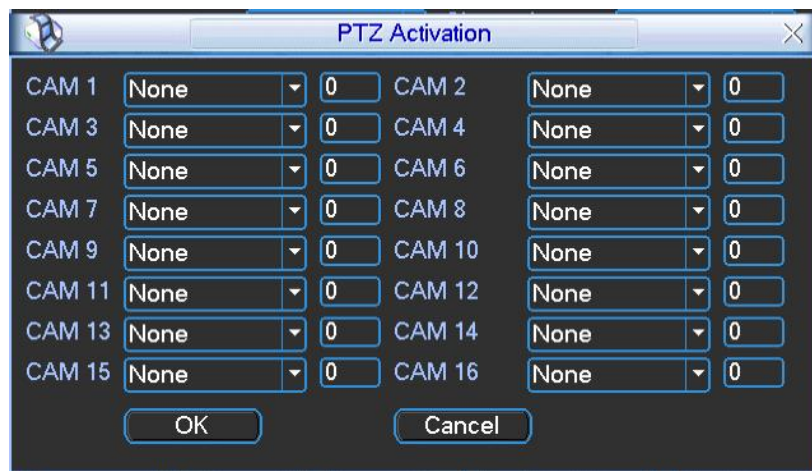

Figure 4-16

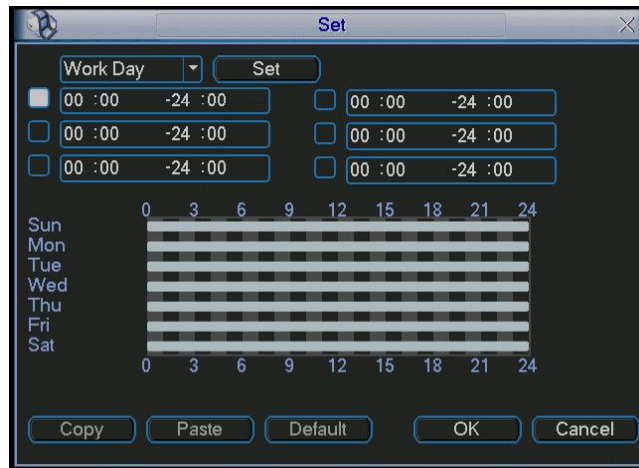

Figure 4-17

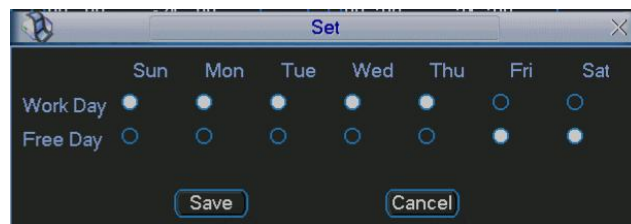

Figure 4-18

### 4.5.3 Video Loss

In Figure 4-14, select video loss from the type list. You can see the interface shown in Figure 4-19. This function allows you to be informed when video loss occurs. You can enable the alarm output channel and then enable show message function.

- Channel: Select the channel you want to enable lens shading alarm.
- Event type: Select video loss.
- Channel: Select the channel to record when video loss occurs.
- Alarm output: Activate peripheral alarm device when video loss occurs.
- Latch: When motion detection completes the system continues detecting for a specified time. The value ranges from 10-300 seconds.
- Show message: System can display a message to alarm you on the local host screen if you enabled this function.
- Send email: System can send out email to alert you when alarm occurs.
- PTZ activation: Here you can set PTZ movement when alarm occurs. Such as go to preset, tour or pattern when there is an alarm. Click “select” button to display interface shown in Figure 4-16.
- Period: Click set button to display an interface shown in Figure 4-17. Here you can set a business day or non-business day. In Figure 4-17, click set button, you can see an interface is shown as in Figure 4-18. Here you can set your own setup for business day or non-business day.
- Sensitivity: There are six levels. The sixth level has the highest sensitivity.
- Alarm output: When alarm occurs, system enables peripheral alarm devices.

- Tour: Here you can enable tour function when alarm occurs. It is a one-window tour. Please go to chapter 5.3.9 Display for tour interval setup.
- Snapshot: System can snapshot when alarm occurs.

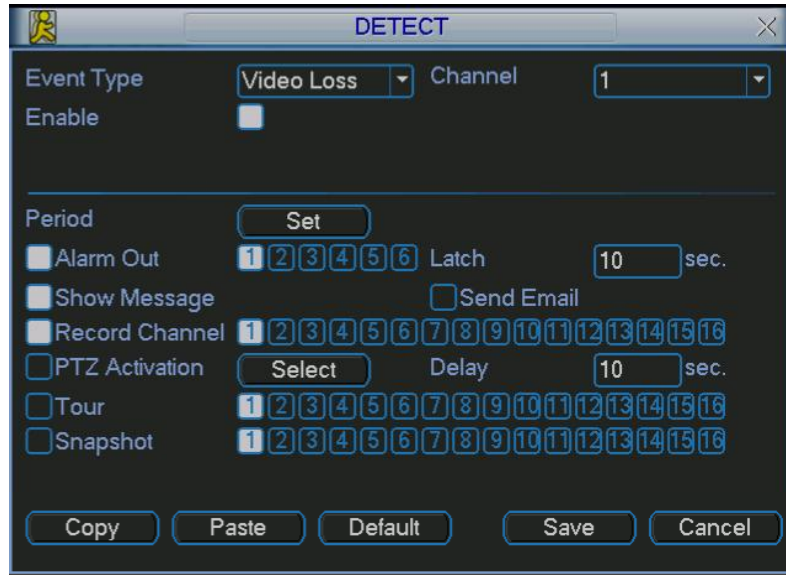

Figure 4-19

#### 4.5.4 Camera Masking

When someone masks the lens, the system can alert you to guarantee video continuity. Camera masking interface is shown in Figure 4-20.

- Channel: Select the channel you want to enable camera mask detection function.
- Event type: Select camera mask detect from the dropdown list.
- Channel: Select the channel to record when camera mask occurred.
- Alarm output: Activate peripheral alarm device when camera mask occurs.
- Enable tour: Activate tour between different cameras.
- Latch: When motion detection completes, system continues detecting for a specified time. The value ranges from 10-300 seconds.
- Show message: System can display a message to alarm you on the local host screen if you enabled this function.
- Send email: System can send out email to alert you when alarm occurs.
- PTZ activation: Here you can set PTZ movement when alarm occurs. Such as go to preset, tour or pattern when there is an alarm. Click “select” button and you will see an interface as shown in Figure 4-16.
- Period: Click set button and you will see an interface as shown in Figure 4-17. Here you can set a business day or non-business day. In Figure 4-17, click set button and you will see an interface as shown in Figure 4-18. Here you can setup ar business day or non-business day.
- Sensitivity: There are six levels. The six-level has the highest sensitivity.
- Alarm output: When alarm occurs the system enables peripheral alarm devices.
- Tour: Here you can enable tour function when alarm occurs. It is a one-window tour. Please go to chapter 5.3.9 Display for tour interval setup.
- Snapshot: System can snapshot when alarm occurs.

**Note:**

In this interface, the copy/paste function is only valid for the same type, which means you cannot copy a channel setup in video loss mode to camera masking mode.

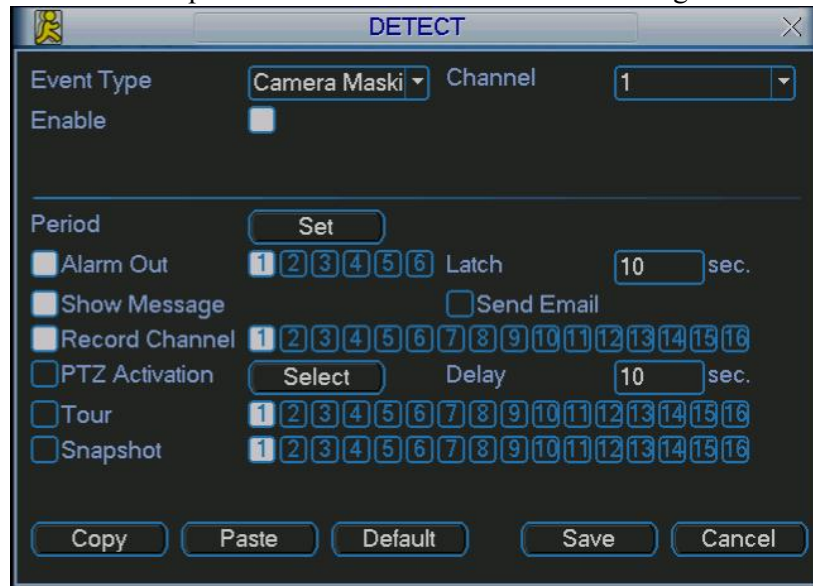

Figure 4-20

## 4.6 Alarm Setup and Alarm Activation

Before operation, please make sure you have properly connected alarm devices such as buzzer.

### 4.6.1 Go to alarm setup interface

In the main menu, from Setting to Alarm, you can see alarm setup interface. See Figure 4-21.

### 4.6.2 Alarm setup

Alarm interface is shown as below. See Figure 4-21.

- Alarm in: Select channel number.
- Event type: There are two types. One is local input and the other is network input.
- Type: Normally open or normally closed.
- PTZ activation: Here you can set PTZ movement when alarm occurs. You can go to preset, tour or pattern when there is an alarm. Click “select” button to see interface as shown in Figure 4-25.
- Period: Click set button and you will see an interface as shown in Figure 4-23. Here you can set a business day or non-business day. In Figure 4-26, click set button to display an interface as shown in Figure 4-27. Here you can set a business day or non-business day.
- Anti-dither: Here you can set anti-dither time.
- Show message: System displays a message to alarm you on the local host screen if you enabled this function.
- Send email: System can send out email to alert you when alarm occurs.
- Record channel: you can select a channel to record alarm video (Multiple choices). At the same time you need to set alarm record in schedule interface (Main Menu->Setting->Schedule) and select schedule record in manual record interface (Main Menu->Advance->Manual Record).

- Latch: Allows the setting of the latch time after the alarm finishes from 10 to 300 seconds. System automatically delays by specified setting in seconds, the switching off of the alarm and activated output, after external alarm is cancelled.
- Tour: Enable tour function when alarm occurs. It is a one-window tour. Please go to chapter 5.3.9 Display for tour interval setup.
- Snapshot: System can snapshot when alarm occurs.

Please highlight icon  to select the corresponding function. After setup click save button and system will return to the previous menu.

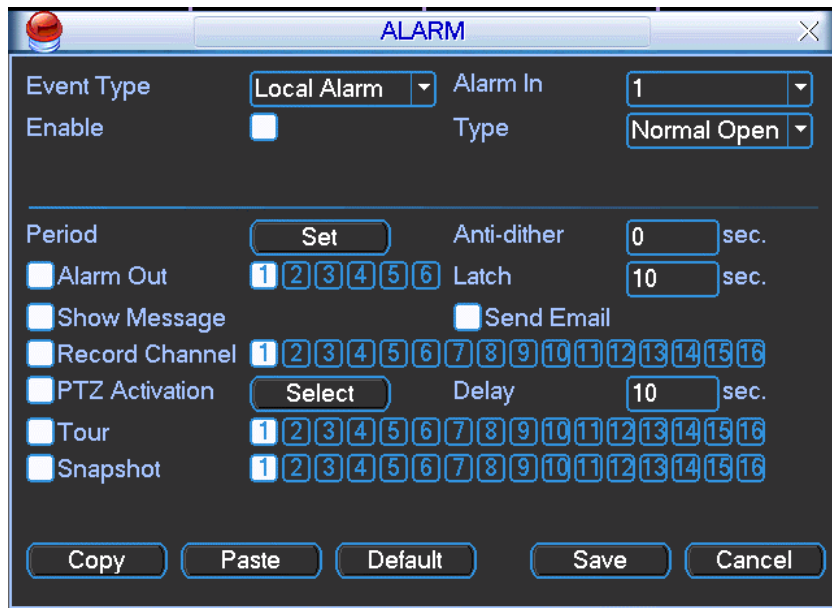

Figure 4-21

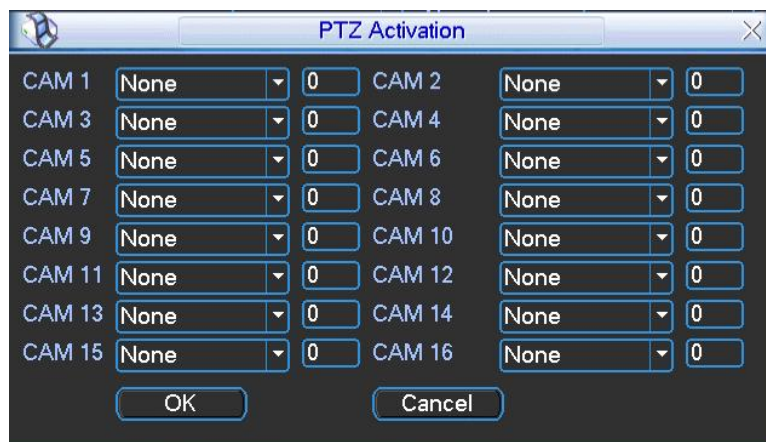

Figure 4-22

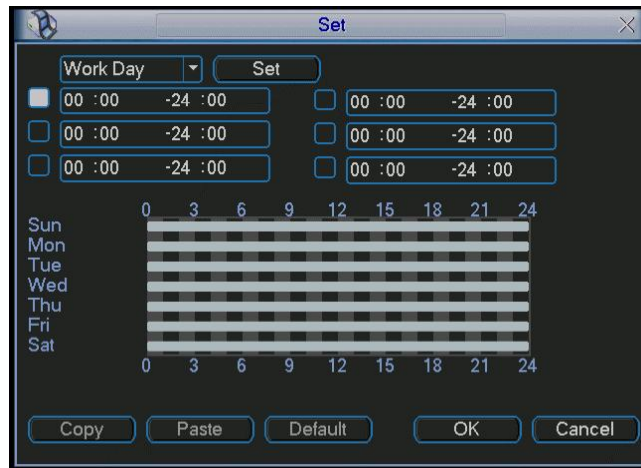

Figure 4-23

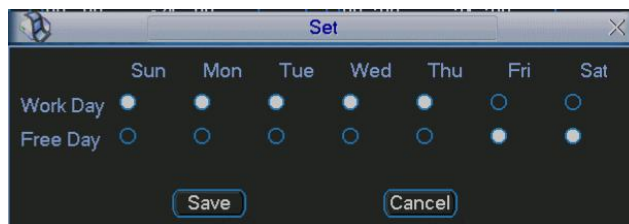

Figure 4-24

## 4.7 Backup

DVR support various backup devices such as CD-RW,DVD driver, USB backup and network download. Here we introduce USB backup first. You can refer to Chapter 7 Web Client Operation for network download backup operation.

### 4.7.1 Detect Device

Click backup button, you can see an interface as shown in Figure 4-25. Here you can view device information.

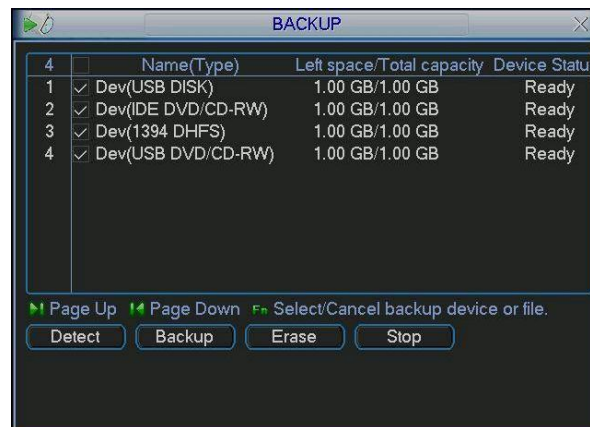

Figure 4-25

### 4.7.1 Backup

Select backup device and then channel, file start time and end time.

Click add button, system begins search. All matched files are listed below. System automatically calculates the capacity needed and remaining. See Figure 4-26.

System only backs up files with a ✓ before channel name. You can use Fn or cancel button to delete ✓ after file serial number.

Click backup button to backup selected files. There is a progress bar for you reference. When the system completes backup you will see a display box prompting successful backup.

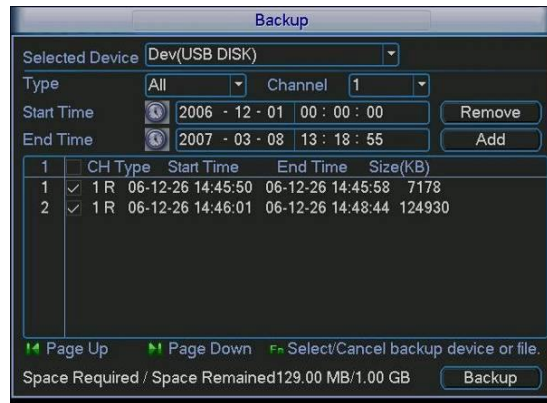

Figure 4-26

Click backup button, system begins burning. At the same time, the backup button becomes a stop button. You can view the remaining time and progress bar at the bottom left. See Figure 4-27.

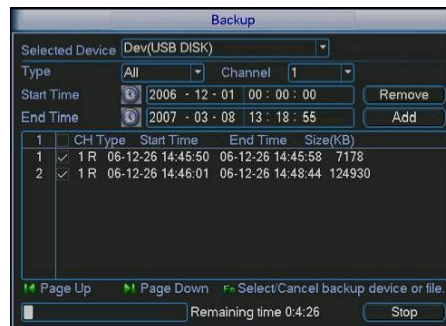

Figure 4-27

#### Tips:

During backup process, you can click ESC to exit current interface but the system will not terminate backup process.

#### Note:

When you click stop button during the burning process, there are two conditions for different devices:



- For CD/DVD burner device, the stop function becomes activated immediately and there is no data in the burner.
- For USB device, system can backup the data before you click stop button. For example, if there is a file of 10 minutes, when you click stop after five minutes backup, system only save the previous 5-minute data in the device.

The file name format usually is: SN\_CH+channel number+time Y+M+D+H+M+S. In the file name, the YDM format is the same as you set in general interface. (Main Menu ->Setting ->General).

## 4.8 PTZ Control and Colour Setup

**Note:** All the operations here are based on PELCOD protocol. For other protocols, there may be some differences.

### 4.8.1 Cable Connection

Please follow the procedures below to go on cable connection

- Connect the dome RS485 port to DVR 485 port.
- Connect dome video output cable to DVR video input port.
- Connect power adapter to the dome.

### 4.8.2 PTZ Setup

**Note:** The camera video should be in the current screen. Before setup, please check the following connections are correct:

- PTZ and decoder connection is right. Decoder address setup is right.
- Decoder A (B) line connects with DVR A (B) line.

Boot up the DVR, input user name and password.

In the main menu, click setting, and then click Pan/Tilt Control button. The interface is shown as in Figure 4-28. Here you can set the following items:

- Channel: Select the current camera channel.
- Protocol: Select corresponding PTZ protocol (such as PELCOD)
- Address: Default address is 1. Best to keep channel and address numbers the same.
- Baud rate: Select corresponding baud rate. Set at 2400.
- Data bits: Select corresponding data bits. Default value is 8.
- Stop bits: Select corresponding stop bits. Default value is 1.
- Parity: There are three options: odd/even/none. Default setup is none.



Figure 4-28

After setup click save button.

In one window display mode, right click mouse (click “Fn” Button in the front panel or click “Fn” key in the remote control) and the interface as shown in Figure 4-29 is displayed.



Figure 4-29

Click Pan/Tilt/Zoom and the interface below is displayed. See Figure 4-30.

Here you can set the following items:

- Step: value ranges from 1 to 8.
- Zoom
- Focus
- Iris



Click icon  and  to adjust zoom, focus and iris.



Figure 4-30

In Figure 4-30, please click direction arrows (See Figure 4-31) to adjust PTZ position. There are total 8 direction arrows.



Figure 4-31

### 4.8.3 3D Intelligent Positioning Key

In the middle of the eight direction arrows there is a 3D intelligent positioning key. See Figure 4-32. Click this key and system goes back to the single screen mode. Drag the mouse on the screen to adjust section size. It can set PTZ automatically.



Figure 4-32

Here is a sheet for your reference.

Name	Function key	function	Shortcut key	Function key	function	Shortcut Key
Zoom		Near	▶		Far	▶▶
Focus		Near	◀		Far	▶
Iris		close	◀		Open	▶

### 4.9 Preset/ Patrol/Pattern/Scan

In Figure 4-30, click the “set” button. The interface is as shown below. See Figure 4-33.

Here you can set the following items:

- Preset
- Tour
- Pattern
- Border



Figure 4-33

In Figure 4-30, click page switch button, the interface is shown as in Figure 4-34. Here you can activate the following functions:

- Preset
- Tour
- Pattern
- Auto scan
- Auto pan
- Flip
- Reset
- Page switch



Figure 4-34

Note: The following setups are usually operated in Figure 4-30, Figure 4-33 and Figure 4-34 .

#### 4.9.1 Preset Setup

In Figure 4-30, use eight direction arrows to adjust camera to the proper position.

In Figure 4-33, click preset button and input preset number. The interface is as shown in Figure 4-35.

Now you can add this preset to a tour.



Figure 4-35

#### 4.9.2 Activate Preset

In Figure 4-34, please input preset number in the No. box and click preset button.

#### 4.9.3 Patrol setup (Tour Setup)

In Figure 4-33, click patrol button. The interface is as shown in Figure 4-36. Input preset number and add this preset to a patrol (tour). For each patrol (tour), you can input a maximum of 80 presets.



Figure 4-36

#### 4.9.4 Activate Patrol (tour)

In Figure 4-33, input patrol (tour) number in the No. box and click patrol button

#### 4.9.5 Pattern Setup

In Figure 4-33, click pattern button and then click “begin” button. The interface is as shown in Figure 4-37. Then you can go to Figure 4-30 to modify zoom, focus, and iris. Go back to Figure 4-37 and click “end” button. You can save all these operations as pattern 1.



Figure 4-37

#### 4.9.6 Activate Pattern Function

In Figure 4-34, input mode value in the No. box and click Pattern button.

#### 4.9.7 Auto Scan Setup

In Figure 4-33 click border button. The interface is as shown in Figure 4-28.

Please go to Figure 4-30, use direction arrows to select camera left limit.

Then please go to Figure 4-38 and click left limit button

Repeat the above procedures to set right limit.



Figure 4-38

#### 4.9.8 Activate Auto Scan

In Figure 4-34, click “Auto Scan” button and the system begins auto scan. Correspondingly, the auto scan button becomes a stop button. Click stop button to terminate scan operation.

#### 4.10 Flip

In Figure 4-34, click page switch button to see an interface as shown in Figure 4-39 below. Here you can set auxiliary function.

Click page switch button again and system goes back to Figure 4-30.

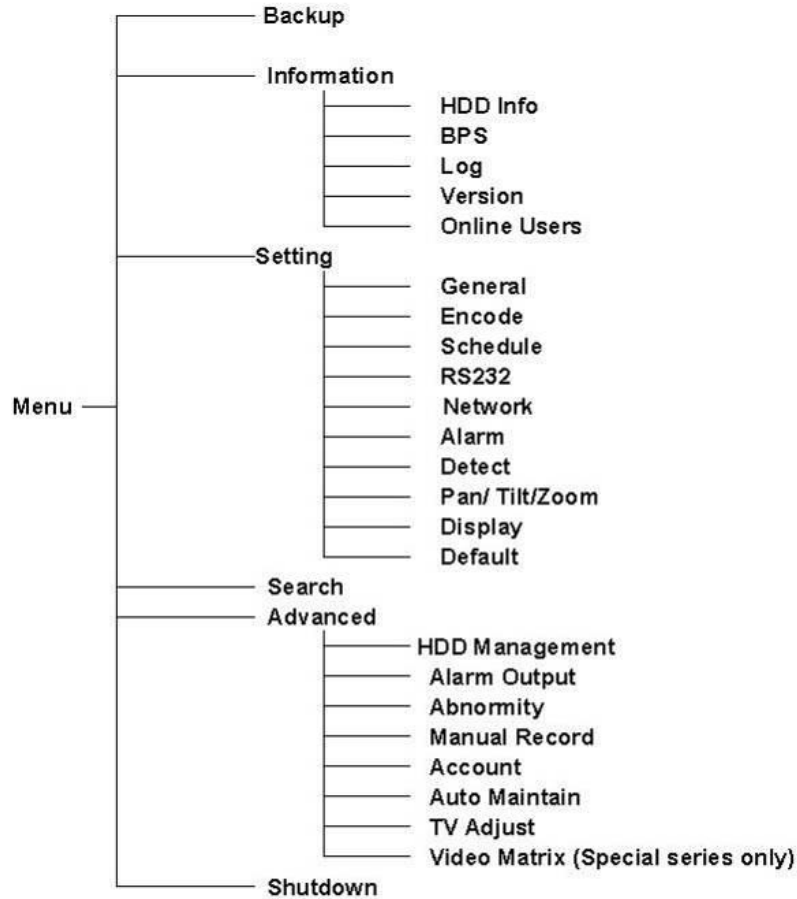

Figure 4-39

## 5 Menu Operations and Controls

### 5.1 Menu Tree

The DVR series menu tree is shown as below.



### 5.2 Main Menu

After you logged in, the system main menu is shown as below. See Figure 5-1 . There are a total of six icons: Search, Information, Setting, Backup, Advanced and Shutdown. Move the cursor to highlight the icon, and then double click mouse to enter the sub-menu.

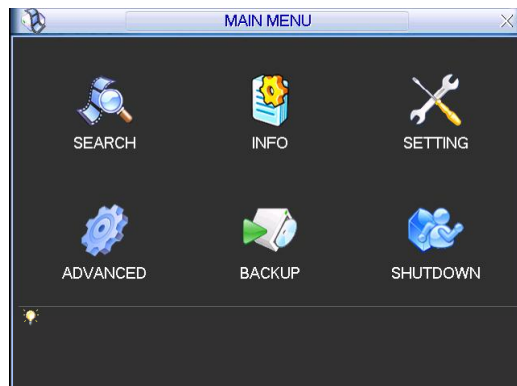

Figure 5-1

## 5.3 Setting

In main menu, highlight Setting icon and double click mouse. System setting interface is shown as below. See Figure 5-2.

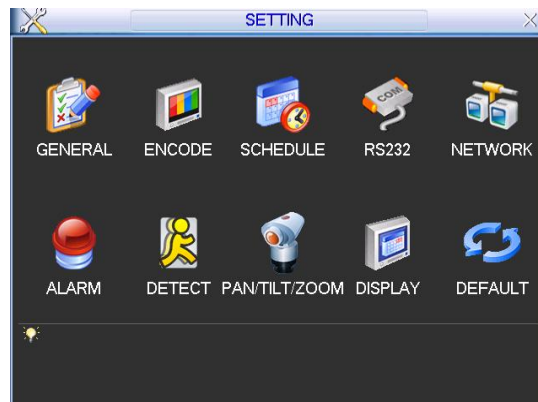

Figure 5-2

### 5.3.1 General

General setting includes the following items. See Figure 5-3.

- **System time:** Set system time
- **Date format:** There are three types: YYYYYY-MM-DD: MM-DD-YYYYYY or DD-MM-YYYY.
- **Date separator:** There are three denotations to separate date: dot, hyphen and colon.
- **Snapshot:** Here you can set image upload interval. (This function applies to some series only).
- **DST:** Here you can set DST time and date. Please enable DST function and then click set button. You can see interface as shown in Figure 5-4. Here you can set start time and end time by setting corresponding week setup. In Figure 5-4, enable date button, you can see an interface as shown in Figure 5-5. Here you can set start time and end time by setting corresponding date setup.
- **Time format:** there are two types: 24-hour mode or 12-hour mode.



- **Language:** System supports various languages: Chinese (simplified), Chinese (Traditional), English, Italian, Japanese, French, Spanish (All languages listed here are optional. Slight difference maybe found in various series.)
- **HDD full:** Select working mode when hard disk is full. There are two options: stop recording or Overwrite. (Overwrite will overwrite oldest file saved on HDD).
- **Pack duration:** Set record duration. Default value is 60 minutes per file created.
- **DVR No:** When you are using one remote control to control several DVRs, you can give a name to each DVR for your management. Default is 8.
- **Video standard:** There are two formats: NTSC and PAL.
- **Auto logout:** Set auto logout interval once login user remains inactive for a specified time. Value ranges from 0 to 60 minutes.

**Note:**

Since system time is very important, do not modify time casually. It is recommended to stop all recording and format the hard drive before changing date or time.

After completing setup please click the save button and system will return to the previous menu.



Figure 5-3

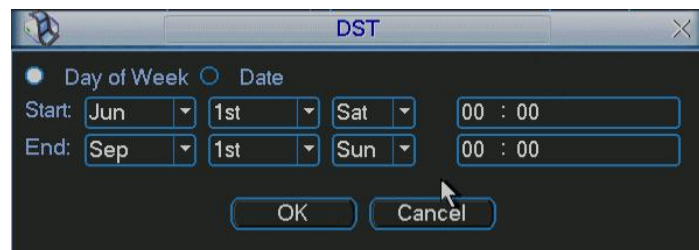

Figure 5-4

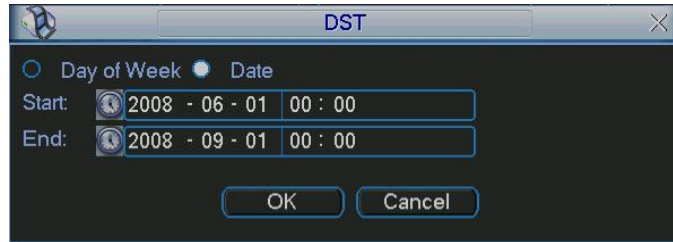

Figure 5-5

### 5.3.2 Encode

Encode setting includes the following items. See Figure 5-6.

Please note some series do not support extra stream.

- **Channel:** Select the channel you want.
- **Compression:** System supports H.264 or you can select from the dropdown list.
- **Resolution:** System supports various resolutions. You can select from the dropdown list.
- **Bit rate:** System supports two types: CBR and VBR. In VBR mode, you can set video quality. Always use VBR when networking unit.
- **Quality:** There are six levels ranging from 1 to 6. The sixth level has the highest image quality.
- **Frame rate:** There are six levels: 1 f/s, 2f/s, 3f/s, 6f/s, 12f/s, 25f/s. (Some series DVRs only support PAL 25f/s )
- **Video/audio:** You can enable or disable the video/audio respectively for the main stream and extra stream.
- **Overlay:** Click overlay button to see interface as shown in Figure 5-7.
- ◇ Cover area (Privacy mask): Set window blanking section. You can drag your mouse to set section size.
- ◇ Preview/monitor: Privacy mask has two types. Preview means the privacy mask zone cannot be viewed by user when system is in preview status. Monitor means the privacy mask zone cannot be view by the user when system is in monitor status.
- ◇ Time display: Select system display time or not when you playback.
- ◇ Channel display: Select channel number or not when you playback.
- **Snapshot:** Click snapshot button to view interface shown in Figure 5-8. (This function applies to some series only)
- ◇ Mode: There are two types: one is timing and the other is activation (trigger).
- ◇ Image size: D1/HD1/BCIF/CIF.
- ◇ Image quality: level 1 to level 6.
- ◇ Snapshot frequency: Here you can set the snapshot frequency. The value ranges from 1s/p to 7s/p.

System default setup is:

- Channel: 1
- Compression: H.264
- Resolution: CIF/D1
- Bit rate: CBR
- Quality: 4
- Frame rate: 25f/s

Please highlight icon  to select the corresponding function.

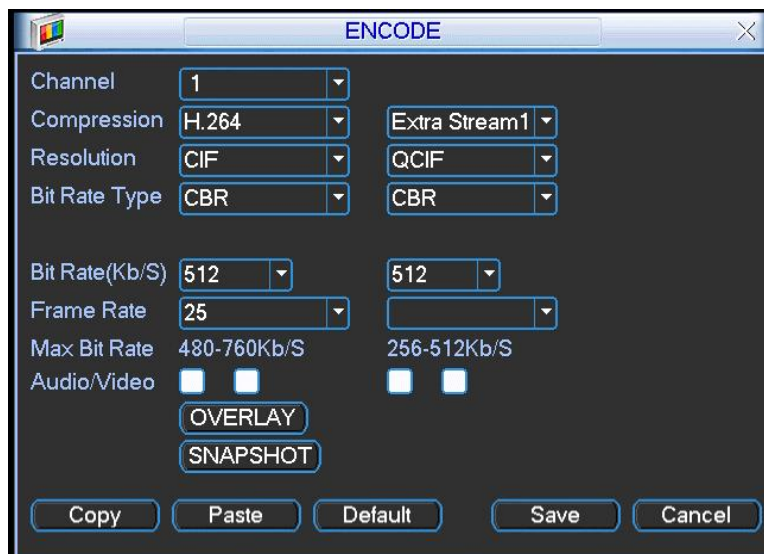

Figure 5-6

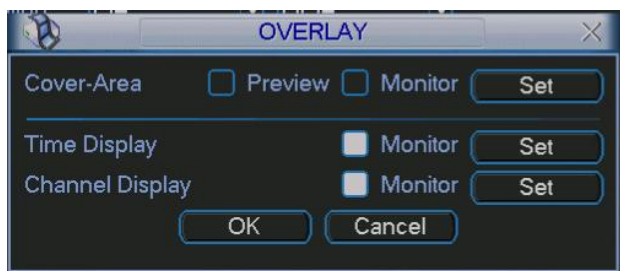

Figure 5-7

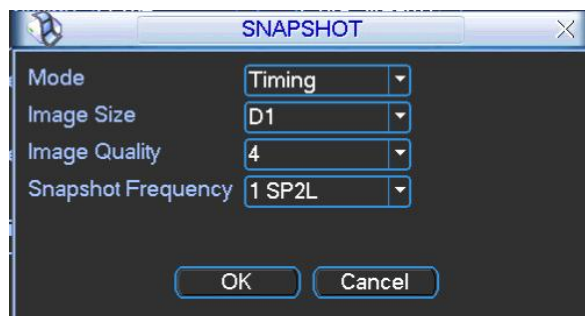

Figure 5-8

The DSD400 series supports various settings for channel, resolution and frame:

Resolution pixel

PAL QCIF=176×144; CIF 352×288; HD1 352×576; 2CIF=704×288;

D1 704×576;

Let's take the 16-channel DVR as an example. There are four groups 1~4, 5~8, 9~12, 13~16.

Please refer to the formula resolution× frame rate

The resources for one group are:

$$D1 \times 50F/s = \text{Half-D1} \times 100F/s = \text{CIF} \times 200F/s$$

You can arrange channel parameter within the specified limit.

Please refer to the following list

Channel resources				Max frame PAL	Note
A	B	C	D		
D1 25F/s	D1 12F/s	D1 6F/s	D1 6F/s	25F/s	1 D1 real-time, 3 D1 non-real time
D1 12F/s	D1 12F/s	D1 12F/s	D1 12F/s	12F/s	4 D1 non-real time
D1 25F/s	HD1 25F/s	CIF 25F/s	CIF 25F/s	25F/s	1 D1,1 HD1, 2 CIF real-time
HD1 25F/s	HD1 25F/s	HD1 25F/s	HD1 25F/s	25F/s	4 HD1 real-time
CIF 25F/s	CIF 25F/s	CIF 25F/s	CIF 25F/s	25F/s	4 CIF real-time
...	...	...	...	...	Other setup

Note

- A B C D is the four channels in one group.
- The total whole resources are limited. When you want to increase resource in one channel you need to reduce resource in another channel.
- The system will display a failure interface if the resource setup is beyond its limit.

In the above list, × means there is no video in current channel. You can highlight “video” button to activate video function.

**Dual encoding streams:** This series support dual encoding streams. Main stream is for local recording, and the extra stream can be used for network transmission. Note that they don't affect each other. So for local recording you can use main stream and for network transmission, you can select main stream or extra stream.

### 5.3.3 Schedule

Please refer to chapter 4.4 Schedule.

### 5.3.4 RS232

RS232 interface is shown as below. Here are five items. See 5.9: There are various devices for you to select. Console is for serial port and Keyboard is for you to use special keyboard to control current device.

- Baud rate: Select baud rate.
- Data bit: Select data bits.
- Stop bit: There are three values: 1, 1.5 and 2.
- Parity: there are three choices: none, odd and even.

After completing all the setups please click save button and system will return to the previous menu.

NOTE: THIS FUNCTION IS NOT SUPPORTED.



Figure 5-9

### 5.3.5 Network

This is where you input network information. See Figure 5-10.

- IP address: Input local IP address.
- DHCP: It an auto search IP function. When enabling DHCP function, you cannot modify IP/Subnet mask /Gateway. These values are supplied by DHCP function. If you have not enabled DHCP function, IP address, Subnet Mask and Gateway are displayed as zero fields. You need to disable the DHCP function to view current IP information. When PPPoE is operating, you cannot modify the IP address, Subnet Mask or Gateway.
- TCP port: Default value is 37777. (System server port 37778 is reserved for UDP use.)
- UDP port: Default value is 37778.
- HTTP port: Default value is 80.
- Max connection: System supports a maximal of 10 users. 0 means there is no connection limit.
- Transfer mode: Here you can select the priority between fluency or video quality.
- Network download: System can process the downloaded data first if you enable this function.

After completing setups click save button and system returns to the previous menu.

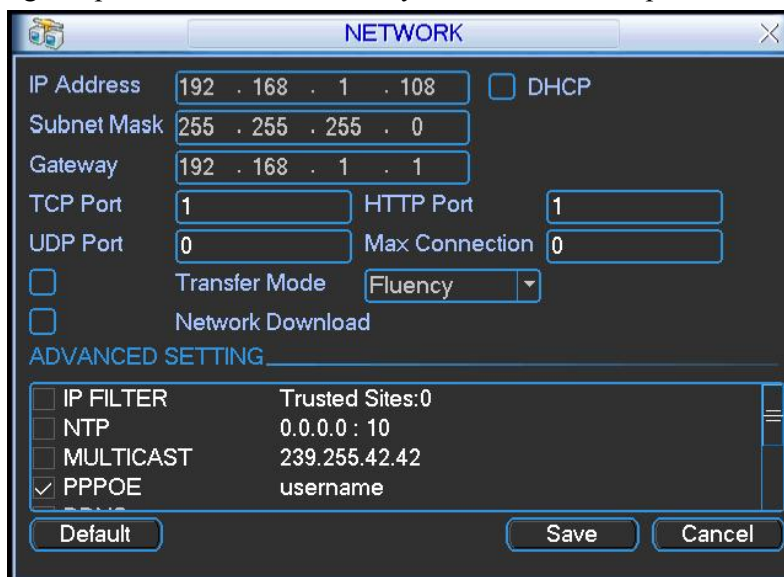

Figure 5-10

### 5.3.5.1 Advanced Setup

Advanced setup interface is shown as in Figure 5-11. Please draw a circle to enable corresponding function and then double click current item to go to setup interface.

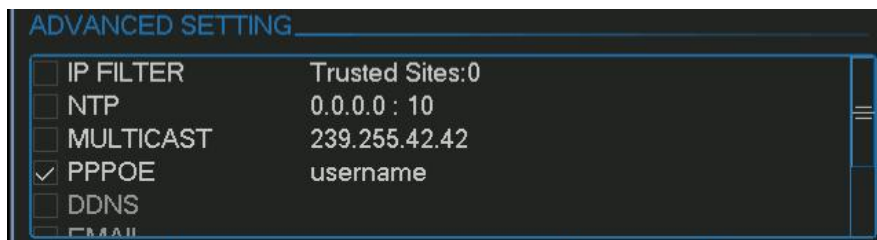

Figure 5-11

### 5.3.5.2 IP Filter

IP filter interface is shown as in Figure 5-12. You can add IP in the following list. The list supports max 64 IP addresses. Please note after you enabled this function, only the IP listed below can access current DVR. If you disable this function, all IP addresses can access current DVR.

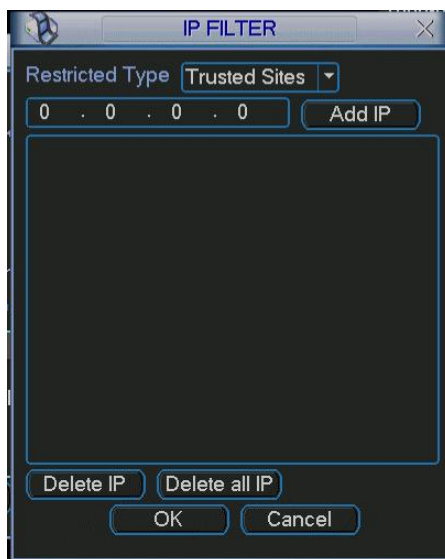

Figure 5-12

### 5.3.5.3 Multiple Cast Setup

Multiple-cast setup interface is shown as in Figure 5-13.

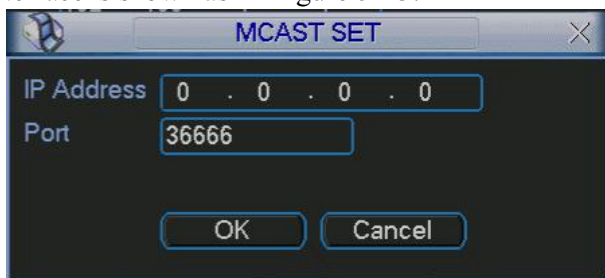

Figure 5-13

Here you can set a multiple cast group. Please refer to the following sheet for detailed information.

- IP multiple cast group address  
-224.0.0.0-239.255.255.255  
-“D” address space
  - The higher four-bit of the first byte=”1110”
- Reserved local multiple cast group address  
-224.0.0.0-224.0.0.255  
-TTL=1 When sending out telegraph  
-For example  
224.0.0.1 All systems in the sub-net  
224.0.0.2 All routers in the sub-net  
224.0.0.4 DVMRP router  
224.0.0.5 OSPF router  
224.0.0.13 PIMv2 router
- Administrative scoped addressees  
-239.0.0.0-239.255.255.255  
-Private address space
  - Like the single broadcast address of RFC1918
  - Cannot be used in Internet transmission
  - Used for multiple cast broadcast in limited space.

Except for the above mentioned addresses for special use, use other addresses. For example:

Multiple cast IP: 235.8.8.36

Multiple cast PORT: 3666.

#### 5.3.5.4 PPPoE

PPPoE interface is shown as in Figure 5-14.

Input “PPPoE name” and “PPPoE password” you get from your ISP (Internet service provider). Check that ISP offers this service.

Click save button. You need to restart DVR to activate your configuration.

After rebooting, IP camera will connect to Internet automatically. The IP in the PPPoE is the DVR dynamic value. You can access this IP to access the unit.

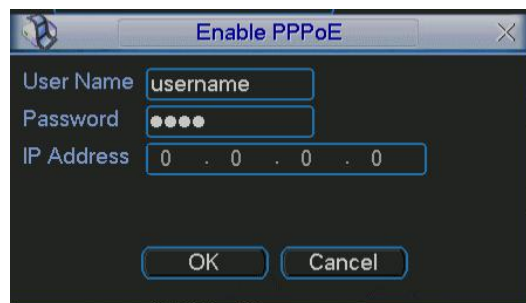

Figure 5-14

### 5.3.5.5 NTP Setup

This option allows for the automatic updating of system time in the DVR so overcoming the need for changing from and to British Summer Time (BST).

You need to install SNTP server (Such as Absolute Time Server) in your PC first. In Windows XP, you can use command “net start w32time” to boot up NTP service.

NTP setup interface is shown as in Figure 5-15.

- Host IP: Input your PC address.
- Port: This series DVR supports TCP transmission only. Port default value is 123.
- Update interval: Minimum value is updating every 15 minutes.
- Time zone: select your corresponding time zone here.

Here is a list for your time zone setup.

City /Region Name	Time Zone
London	GMT+0
Berlin	GMT+1
Cairo	GMT+2
Moscow	GMT+3
New Deli	GMT+5
Bangkok	GMT+7
Beijing (Hong Kong)	GMT+8
Tokyo	GMT+9
Sydney	GMT+10
Hawaii	GMT-10
Alaska	GMT-9
Pacific Time(P.T)	GMT-8
American Mountain Time(M.T)	GMT-7
American Central Time(C.T)	GMT-6
American Eastern Time(E.T)	GMT-5
Atlantic Time	GMT-4
Brazil	GMT-3
Middle Atlantic Time	GMT-2

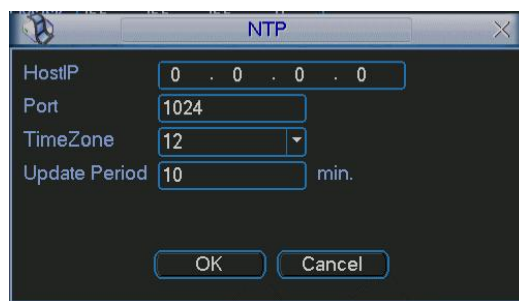

Figure 5-15

### 5.3.5.6 Email Setup

Email setup interface is shown as in Figure 5-16. Here you can set email server information.

**Note:**

You need to get the email address from your email service provider first.

Please use semicolon to separate the addresses.



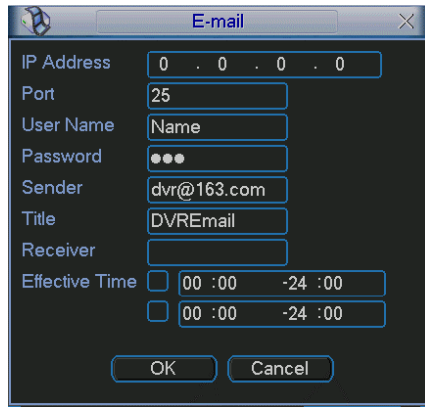

Figure 5-16

### 5.3.5.7 DDNS Setup

DDNS setup interface is shown in Figure 5-17.

You need a PC of fixed IP on the internet and DDNS is running in this PC. In other words, this PC is a DNS (domain name server).

In network DDNS, input your PPPoE name you get from you IPS and server IP (PC with DDNS ) . Click save button and then reboot system.

Click save button and system prompts for rebooting activate changes.

After rebooting, open IE and input as below:

http //(DDNS server IP)/(virtual directory name)/webtest.htm

e.g.: http //10.6.2.85/DVR\_DDNS/webtest.htm.)

Now you can open DDNSServer web search page.

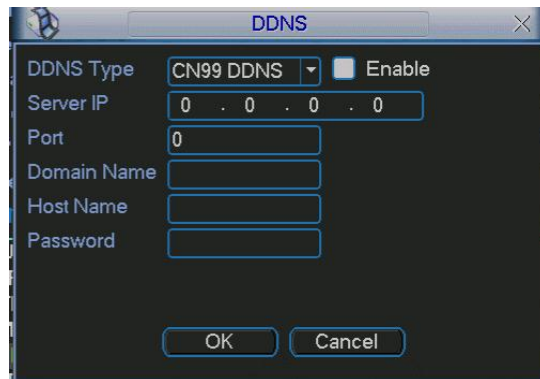

Figure 5-17

### 5.3.5.8 Alarm Server

You can set alarm in accordance with different alarm protocols. System can inform the alarm server when alarm occurs. See Figure 5-18.



Figure 5-18

### 5.3.5.9 FTP

You need to download or buy FTP service tool (such as Ser-U FTP SERVER) to establish FTP service.

Please install Ser-U FTP SERVER first. From “start” -> “program” -> Serv-U FTP Server -> Serv-U Administrator. Now you can set user password and FTP folder. Please note you need to grant write rights to FTP upload user. See Figure 5-19.

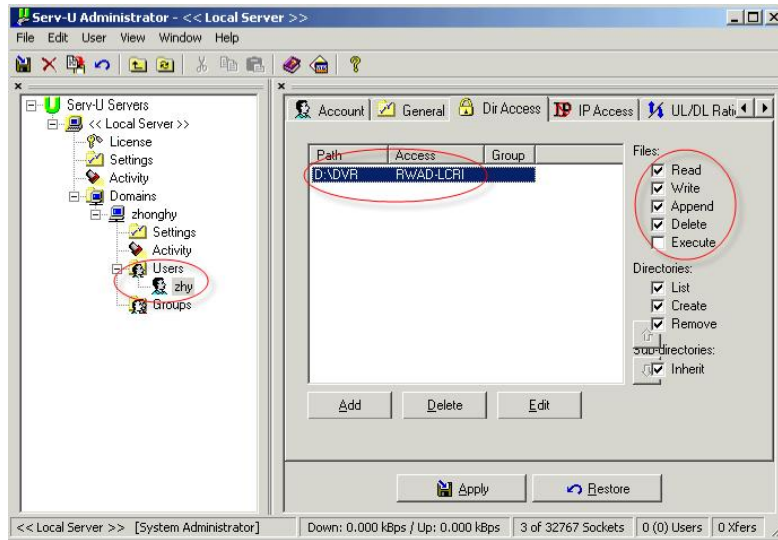

Figure 5-19

You can use a PC or FTP login tool to test setup is right or not.

For example, you can login user ZHY to [FTP://10.10.7.7](ftp://10.10.7.7) and then test it can modify or delete folder or not. See Figure 5-20.



Figure 5-20

System also supports upload multiple DVRs to one FTP server. You can create multiple folders under this FTP.

In Figure 5-10, select FTP and then double click mouse. You can see the following interface. See Figure 5-21.

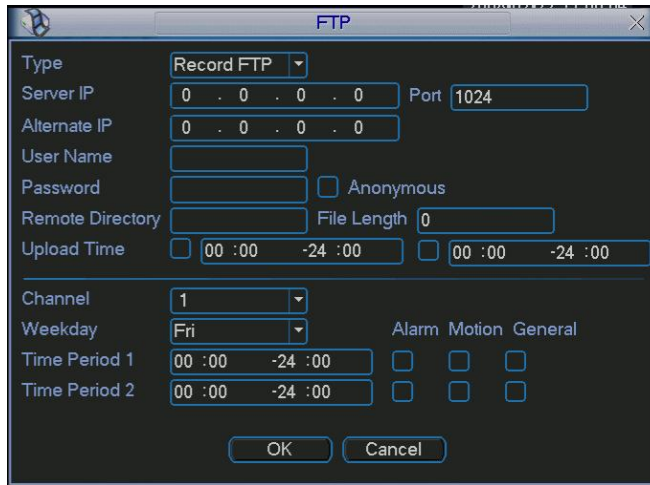

Figure 5-21

Please highlight the icon  in front of Enable to activate FTP function.

Now FTP can upload alarm video and motion detection video. Please note, when you are using this function, please make sure current upload channel is in motion detection or alarm record status and there is video available.

Here you can input FTP server address, port and etc.

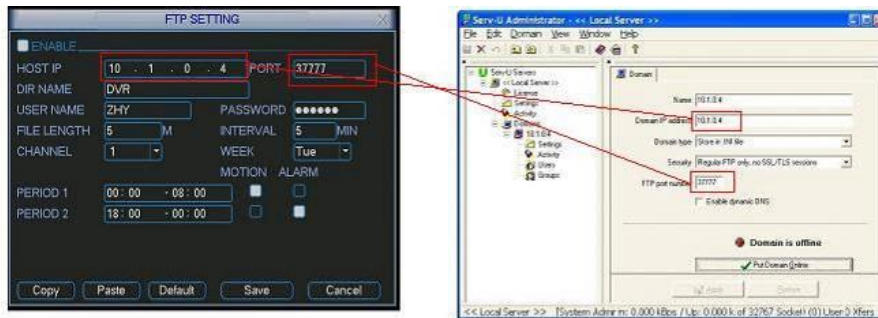

Figure 5-22

- File length: Upload file length. When setup is larger than the actual file length, system will upload the whole file. When setup here is smaller than the actual file length, system only uploads the set length and auto ignores the remaining section.
- When interval value is 0, system uploads all corresponding files.
- Period 1 and period 2: You can set two periods for one each channel.

System file name is shown as in . Figure 5-23.



Figure 5-23

### 5.3.6 Alarm

Please refer to chapter 4.6 Alarm Setup and Activation.

### 5.3.7 Detect

Please refer to chapter 4.5 Detect.

### 5.3.8 Pan/Tilt/Zoom

The pan/tilt/zoom setup includes the following items. Please select channel first. See Figure 5-24.

- Protocol: Select corresponding PTZ protocol such as PELCOD.
- Address: Input corresponding PTZ address.
- Baud rate: Select baud rate.
- Data bit: Select data bit.
- Stop bit: Select stop bit.
- Parity: there are three choices: none, odd or even.

After completing setup please click the save button and system returns to the previous menu.

For detailed setup, please refer to chapter 4.9 preset/patrol/pattern/scan.





Figure 5-24

### 5.3.9 Display

Display setup interface is shown below. See Figure 5-25.

- Transparency: Adjust transparency. The value ranges from 128 to 255.
- Channel name: Change channel name. Please note that all modifications here only apply to the DVR local end. You need to open web or client end to refresh channel name also.
- Time display: Select display time or not when system is in playback mode.
- Channel display: Select display channel name or not when system is in playback mode.
- Overlay information: System displays some information on the screen for your reference.
- Display mode: Select from the dropdown list: self-adaptive/VGA/TV.
- Enable tour: Activate tour function.
- Interval: Input interval value here. The value ranges from 5-200 seconds.

- In tour process, you can use mouse or click Shift to turn on window switch function.
-  Stands for opening switch function,  stands for closing switch function.
- Motion tour type: System support 1/8 window tour.
- Alarm tour type: System support 1/8 window tour.

Please highlight icon  to select the corresponding function.

After completing setup click save button and system will return to the previous menu.

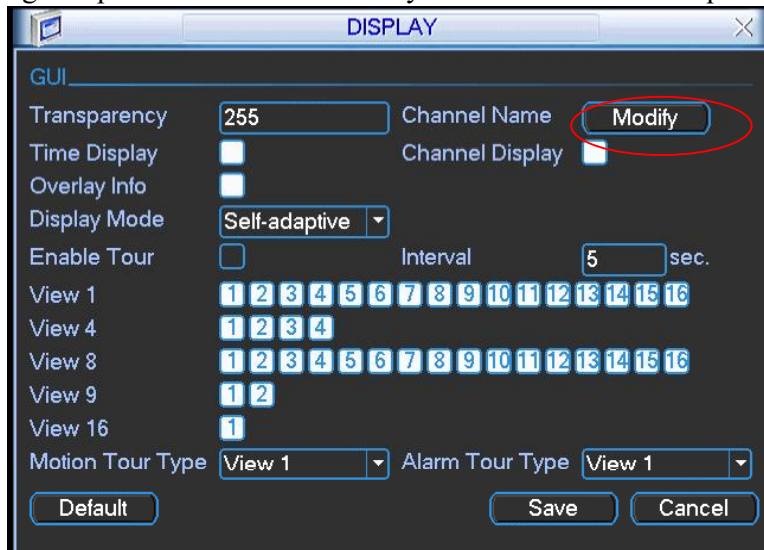

Figure 5-25

In Figure 5-25, click modify button after channel. You can see an interface shown as in Figure 5-26. Please note all your modifications here apply to the local end only. You need to refresh web or client-end to set the latest channel name. System max supports 25-digital characters.

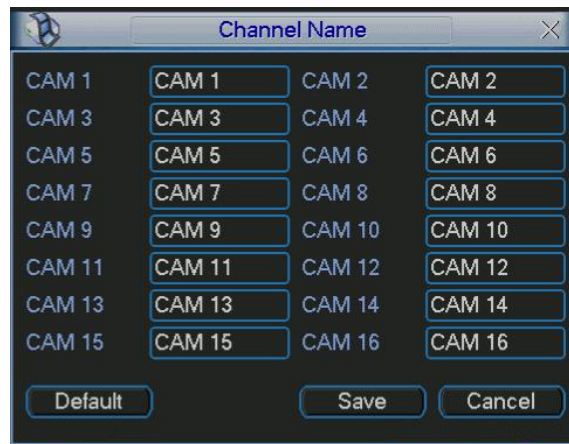



Figure 5-26

In tour mode, you can see the following interface. On the right corner, right click mouse or click shift button so you can control the tour. There are two icons:  stands for enabling window switch and  stands for enabling window function. See Figure 5-27.

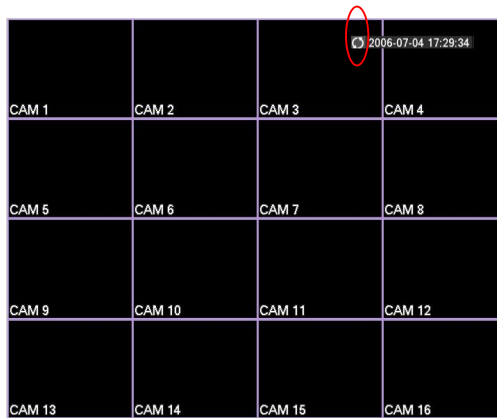



Figure 5-27

### 5.3.10 Default

Click default icon to display dialogue box. You can highlight  to restore default factory setup. See **Error! Reference source not found.**

- Select all
- General
- Encode
- Schedule
- RS232
- Network
- Alarm
- Detect
- Pan/tilt/zoom
- Display
- Channel name

Please highlight icon  to select the corresponding function.

After setup please click the save button and system will return to the previous menu.

#### **Warning!**

System menu colour, language, time display mode, video format, IP address, user account will not maintain previous setup after default operation!



Figure 5-28

## 5.4 Search

Please refer to chapter 4.3 Search.

## 5.5 Advanced

Double click advanced icon in the main window and the interface below is displayed. See Figure 5-29. There are total seven function keys: HDD management, alarm output, abnormality, manual record, account, auto maintain, and TV adjust.



Figure 5-29

### 5.5.1 HDD Management

Here is where you implement hard disk management. See **Error! Reference source not found.**

You can set the mode for each hard disk from the dropdown list.

When you use the redundant backup function, you can set one or more redundant HDD(s). Please note you need to set at least one read-write disk, otherwise system will not record video. For detailed information you can refer to chapter 4.4 Schedule.

After setup complete please click save button. The system will need rebooting to save these changes.



Figure 5-30

Click alarm set button, the interface is shown as below. See Figure 5-31 (This interface is just like the abnormality setup).

Please highlight icon  to select the corresponding function.

You can enable one or more alarm setups. The lower limit ranges from 1% to 99%. Alarm channel number ranges from 1 to 6. Delay value is from 0 to 240 seconds.

Please note when HDD capacity is not full system only alarms once!

After setup click the OK button and system returns to the previous menu.

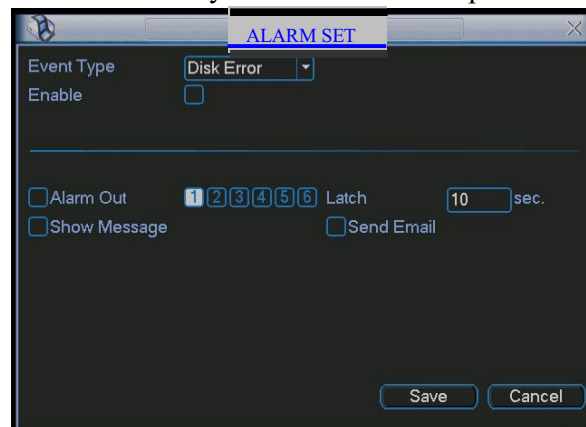

Figure 5-31

### 5.5.2 Abnormity

The Abnormity interface is shown in Figure 5-32.

- Event type: There are several options for you such as disk error, no disk etc.
- Alarm output: Alarm activation output port (multiple choices), among which is controllable 12V output.
- Latch: Set corresponding delay time. The value ranges from 10s-300s. System automatically delays specified seconds in turning off alarm and activated output after external alarm cancelled.
- Show message: System can display the message in the local screen to alert you when alarm occurs.
- Send email: System can send out an Email to alert you when alarm occurs.



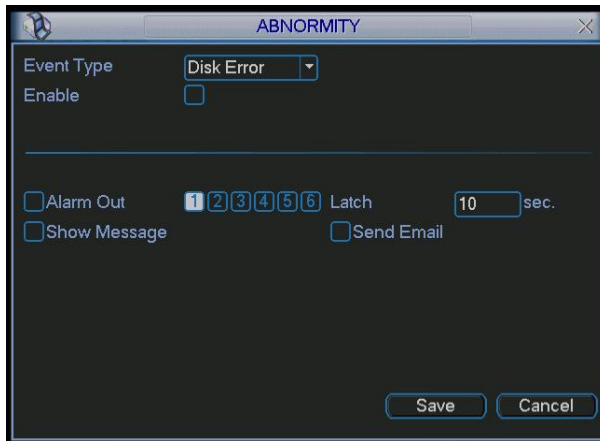



Figure 5-32

### 5.5.3 Alarm Output

Please highlight icon  to select the corresponding alarm output.

After setup click the OK button and system goes back to the previous menu. See Figure 5-33.

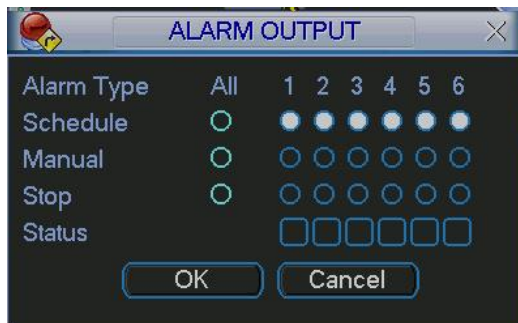

Figure 5-33

### 5.5.4 Manual Record

Please refer to chapter 4.2.2 manual record.

### 5.5.5 Account

This is where you set the Users and passwords. See Figure 5-34.

You can do the following:

- Add new user
- Modify user
- Add group
- Modify group
- Modify password.

For account management please note:

- System account adopts two-level management: group and user. No limit to group or user settings.
- For group or user management, there are two levels: admin and user.

- The user name and group name can consist of eight bytes. One name can only be used once. There are four default users: admin/888888/666666 and hidden user “default”. Except for user 666666, all users have administrator rights.
- Hidden user “default” is for system interior use only and cannot be deleted. When there is no login user, the hidden user “default” automatically logs in. You can set some rights such as monitor for this user so that you can view some channel views without logging in.
- One user should belong to one group. User rights cannot exceed group rights.
- About reusable function: This function allows multiple users to use the same account to login.

After setup please click save button and system returns to the previous menu.

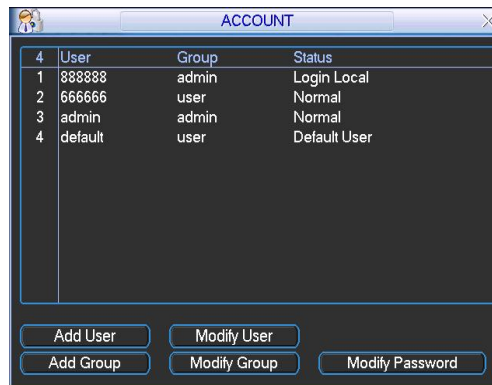

Figure 5-34

### 5.5.6 Auto Maintain

Here you can set auto-reboot time and auto-delete old files setup. See Figure 5-35. You can select required option from dropdown list.

After setup click on the save button and the system returns to the previous menu.

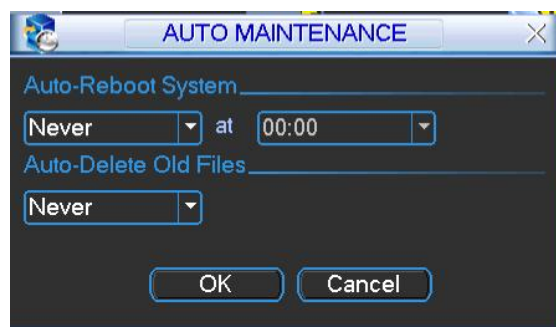

Figure 5-35

### 5.5.7 TV Adjust

This is for adjusting the TV output setup. See Figure 5-36.

Please drag slide bar to adjust each item.

After setup click the OK button and system returns to the previous menu.



Figure 5-36

### 5.5.8 Video Matrix (For GBEH--S and GBEL-S Series only)

Some series DVR have the matrix and loop outputs.

#### 5.5.8.1 Loop outputs

They are just the same with video distributors. There are 4/8/16-ch video loop outputs from our DVR. The DVR video output can connect with other devices such as TV walls, analog matrix and so on.

#### 5.5.8.2 Matrix outputs

They are like the small-scale matrix. You can select any camera from our DVR to switch. And the output can also tour between the cameras. So the matrix outputs can be used to build TV walls and tour and display the cameras one by one.

#### 5.5.8.3 Rear Panel Connection

The rear panel is shown as below. See Figure 5-37.

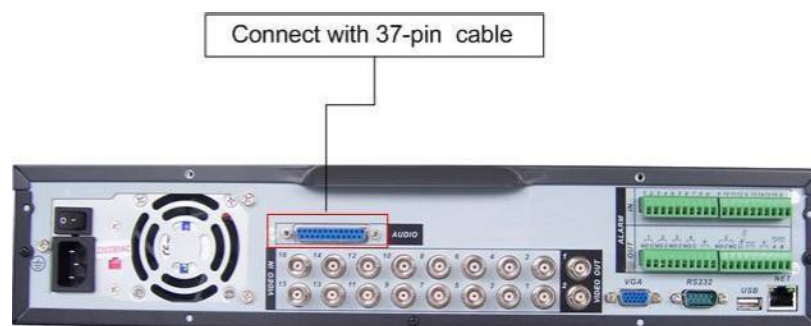

Figure 5-37

#### 5.5.8.4 37-pin cable introduction

There are three colors cable. See Figure 5-38.

- Black: for loop outputs, there are 16-ch loop outputs
- Blue: for matrix outputs, there are 4-ch matrix outputs
- White: for bi-direction talk, one is for audio in and the other is for audio out.



Figure 5-38

### 5.5.8.5 **Matrix setup** (This option is not available on the DSD400 DVR range)

#### 5.5.8.5.1 Enter Video Matrix Interface

In the menu, from “Advanced” to “Video Matrix”. You can see an interface is shown as in Figure 5-39.



Figure 5-39

#### 5.5.8.5.2 **Right Mouse Menu**

In one-window display mode, right click mouse to select “Video Matrix”. See Figure 5-40.

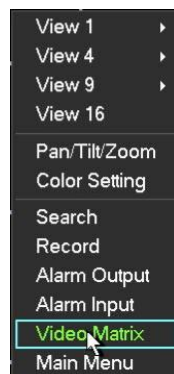

Figure 5-40

### 5.5.8.6 **Video Matrix Interface and Application**

The video matrix interface is shown as in Figure 5-41.

You can set for each channel. The function consists of three types. The priority is: alarm>motion detection>schedule.

#### 5.5.8.6.1 Scheduled Video Output (Scheduled Tour)

Please enable corresponding video output item and input tour interval, and then set the tour output channel. System supports 16 channels. Now system can implement tour output.

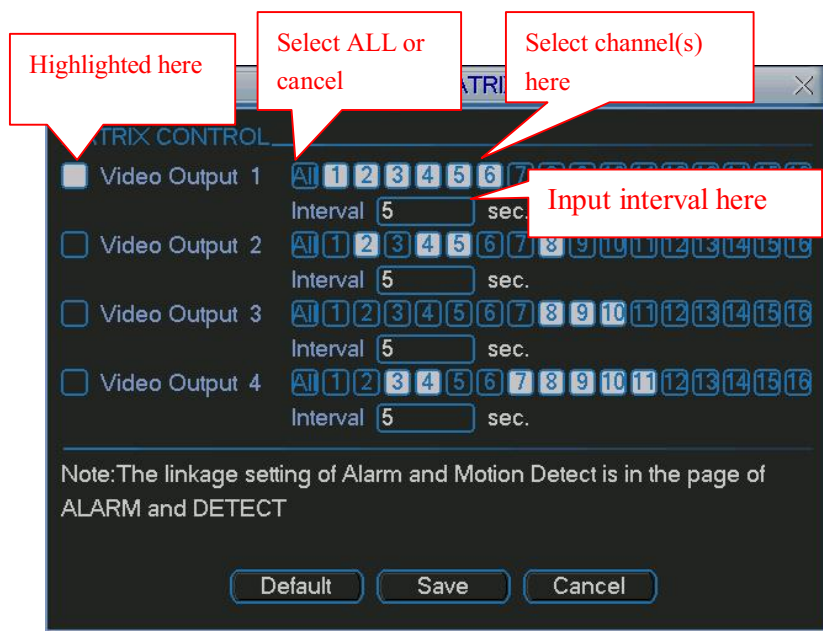

Figure 5-41

#### 5.5.8.6.2 Alarm Activation Matrix

Please go to alarm setup interface to set the alarm activate matrix function ((Main Menu->Setting->Alarm)). See Figure 5-42. You can follow the steps listed below:

- Select local alarm
- The record channel function has been enabled and you have selected corresponding record channel.
- The video matrix function has been enabled and you have selected corresponding video matrix channel.

After selecting activation channel in the record channel item, you can enable video matrix function and then select vide output channel. Once the alarm occurs, system continues scheduled matrix tour after alarm tour completes. If there is no scheduled tour available, the matrix will stop at the last activation channel after alarm completes.

When there are several alarm inputs at the same time, the situation maybe a little bit complex. Here is an example.

System setup is shown as below:

- Alarm input 1 can activate channel1/2/3/4/5/6
- Alarm input 2 can activate channel 2/3/4/5/6/7/8
- Alarm input 1 and alarm input 2 activate video output 1.

So, when there is an alarm from channel 1, video output 1 becomes valid. If there is no alarm from alarm input 2 during the same period, then video output 1 can tour between channel1/2/3/4/5/6.

When video output 1 goes to channel 3 and there is alarm from channel 2, then video output 1 tour begins between 4/5/6/7/8/2.

The general principles are:

- When alarm activates, each valid channel alarm input can activate a complete tour between activation channels.
- When there are several alarm inputs in the same video matrix output, system video matrix can activate all the channels in the setup.
- If system has toured some activation channels, then corresponding alarm activation channels are disregarded

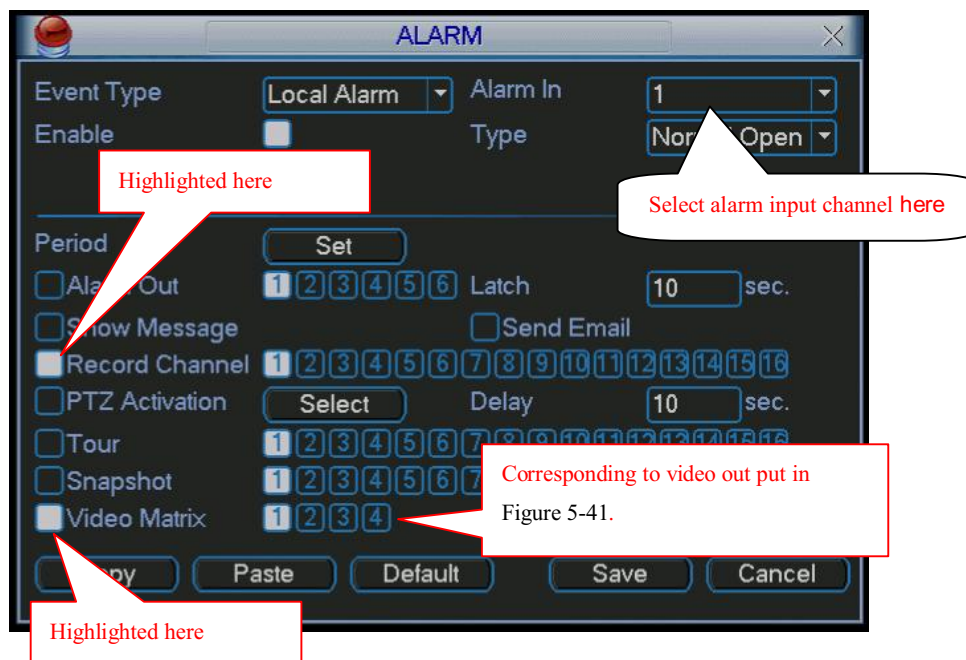

Figure 5-42

### 5.5.8.6.3 Motion Detection (including video loss and camera masking)

Motion detection principle is the same as alarm. You can set in motion detection interface (Main menu->Setting->Detect). See **Error! Reference source not found..**

In detect interface, you can set the activation channel. You can enable video matrix function if you want to set matrix function, and then set video matrix output channel. Once the activation occurs, system continues scheduled matrix tour after motion detection tour completes. If there is no scheduled tour available, the matrix will stop at the last activation channel after alarm completes

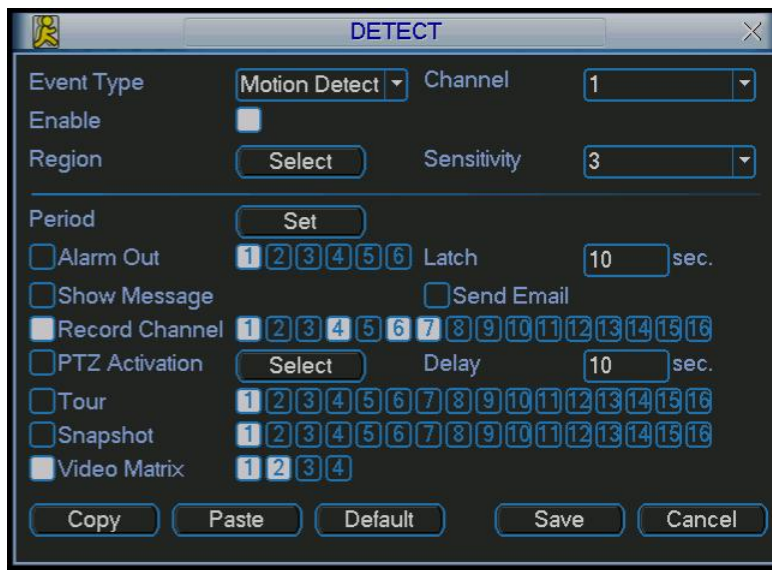

Figure 5-43

#### 5.5.8.6.4 General Tour Principle

When system is in scheduled tour status, once the alarm occurs, system first checks video matrix function has been enabled or not, and if there is an effective matrix or not. System will continue implementing scheduled tour in the following two conditions:

- Video output function has not been enabled.
- There is no video matrix setup available.

If there is a valid video matrix setup, system can activate corresponding tour among alarm channels and then begin scheduled tour after alarm tour completes.

If there is no schedule tour available, the matrix will stop at the last activation channel after alarm completes.

Motion detection activation is almost the same as the alarm. But it has different priority. System will continue implementing scheduled tour in the following two conditions:

- Video output function has not been enabled.
- There is no video matrix setup available.

If there is a valid video matrix setup, system will check whether there is a tour of higher priority and implement corresponding process. During the motion detection tour, the system will process alarm first if alarm occurs. It is the same as an alarm occurring in the scheduled tour period.

## 5.6 Information

This menu is for viewing system information. There are a total of five options: HDD (hard disk information), BPS (data stream statistics), Log, Version, and Online Users. See Figure 5-44.

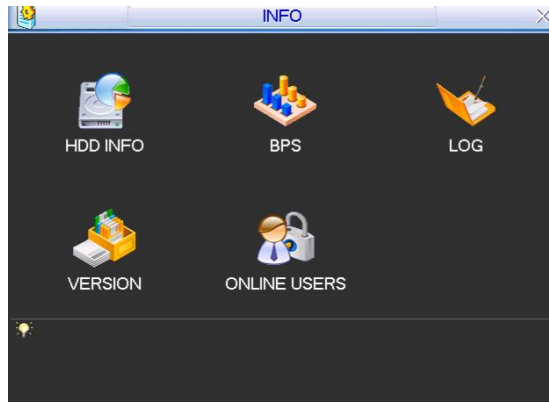

Figure 5-44

### 5.6.1 HDD Information

This lists hard disk type, total space, free space, video start time and status. See Figure 5-45.

**Note:**

Please remove the failed hard disk before you add a new one.

If there is a hard disk conflict please check hard disk time and system time are identical. If not then go to the Setting menu and then General to modify system time. Finally reboot the system to resolve this problem. If disk is damaged, system shows as “?”

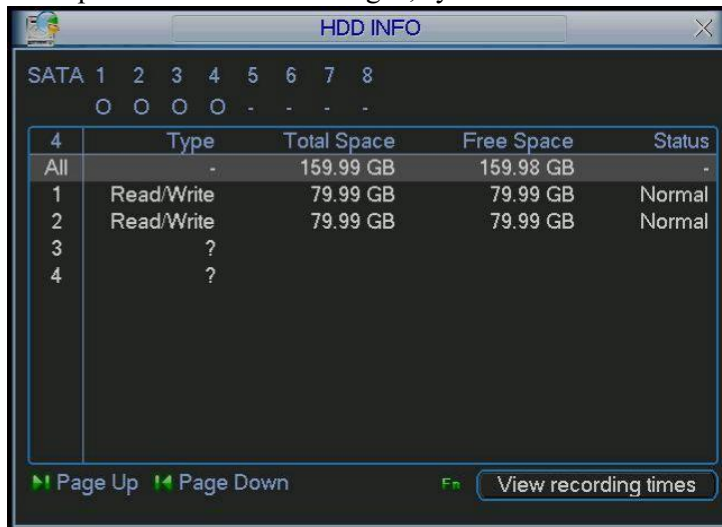

Figure 5-45

### 5.6.2 BPS

Here is where you view current video data stream (KB/s) and occupied hard disk storage (MB/h). See Figure 5-46.



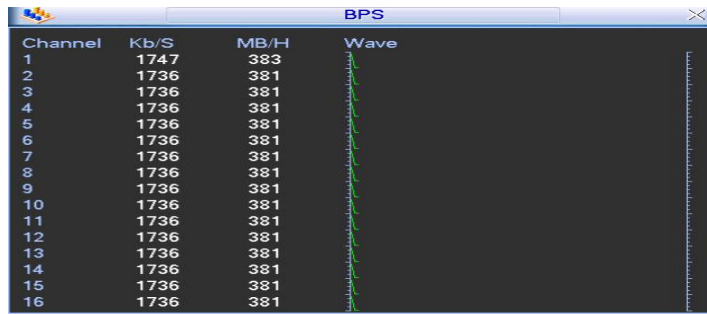

Figure 5-46

### 5.6.3 Log

This lets you view the system log file. System lists the following information. See Figure 5-47.

Log types include system operation, configuration operation, data management, alarm event, record operation, log clear etc.

Please select start and end time, and then click the Search button. You can view the log files.

Press page up/down button to view if there are more than ten files.

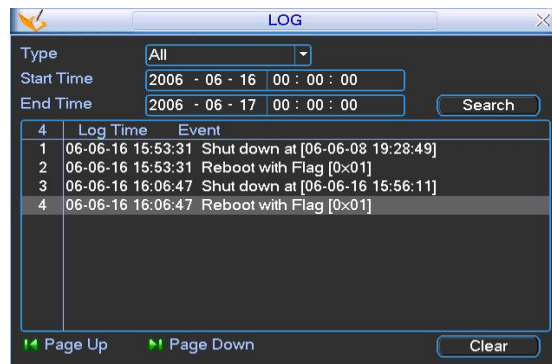

Figure 5-47

### 5.6.4 Version

This is where you can view version information. See Figure 5-48.

- Channel
- Alarm in
- Alarm out
- System version:
- Build Date

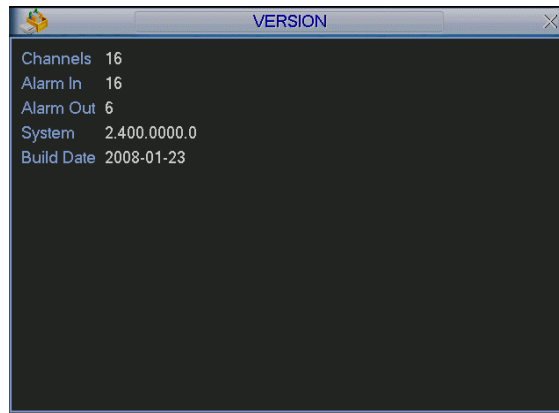

Figure 5-48

### 5.6.5 Online Users

This is where you manage online users. See Figure 5-49.

You can disconnect one user or block one user if you have correct system rights.

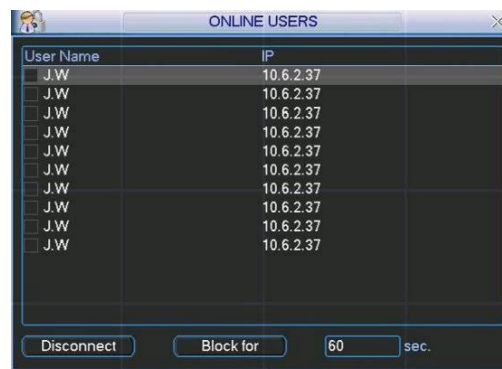

Figure 5-49

## 5.7 Exit

Double click exit button and system displays a dialogue box for you to select. See Figure 5-50.

- Logout menu user: Log out menu. You need to input password when you login the next time.
- Restart application: Reboot DVR.
- Shutdown: System shuts down and turns off power.
- Restart system: System begins rebooting.
- Switch user: You can use another account to log in.

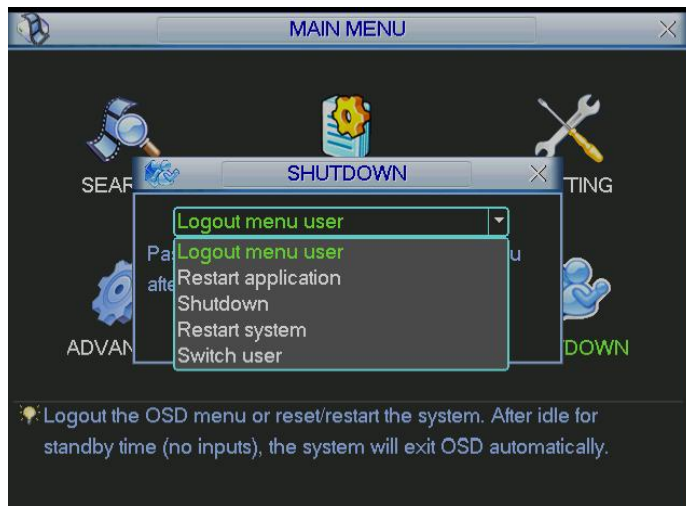

Figure 5-50

## 6 About Auxiliary Menu

### 6.1 Go to Pan/Tilt/Zoom Menu

In the one-window surveillance mode, right click mouse (click “fn” Button in the front panel or click AUX key in the remote control). The interface is shown below: See Figure 6-1.



Figure 6-1

Click Pan/Tilt/Zoom and the interface in Figure 6-2 will be displayed.

Here you can set the following items:

- Zoom
- Focus
- Iris



Click icon  and  to adjust zoom, focus and Iris.



Figure 6-2

In Figure 6-2, please click direction arrows (See Figure 6-3 ) to adjust PTZ position. There are a total of eight direction arrows. (Please note there are only four direction arrows in DVR front panel.)



Figure 6-3

### 6.1.1 3D Intelligent Positioning Key

In the middle of the eight direction arrows, there is a 3D intelligent positioning key. See Figure 6-4 . Click this button and system will revert to single screen mode. Drag the mouse in the screen to adjust section size.



Figure 6-4

Note the following for reference.

Name	Function key	function	Shortcut key	Function key	function	Shortcut key
Zoom		Near	▶		Far	▶▶
Focus		Near	◀		Far	▶
Iris		close	◀		Open	▶

## 6.2 Preset /Patrol / Pattern /Border Function

In Figure 6-2 click the set button. The interface is shown as below:

Here you can set the following items:

- Preset
- Patrol
- Pattern
- Border



Figure 6-5

In Figure 6-2, click page switch button and you will see an interface as in Figure 6-6.

Here you can activate the following functions:

- Preset
- Tour(Patrol)
- Pattern
- Auto scan
- Auto pan
- Flip
- Page Switch



Figure 6-6

### 6.2.1 Preset Setup

**Note:** The following setups are usually operated in Figure 6-2, Figure 6-5 and Figure 6-6. In Figure 6-2, use eight direction arrows to adjust camera to the correct position. In Figure 6-5, click preset button and input preset number. The interface is shown as in Figure 6-7.

Add this preset to one patrol number



Figure 6-7

### 6.2.2 Activate Preset

In Figure 6-6 please input preset number in the No. blank, and then click the preset button.

### 6.2.3 Patrol Setup

In Figure 6-5, click patrol button. The interface is shown in Figure 6-8. Input preset number and then add this preset to one patrol.



Figure 6-8

### 6.2.4 Activate Patrol

In Figure 6-6, input patrol number in the No. blank and then click the patrol button

### 6.2.5 Pattern Setup

In Figure 6-5, click pattern button and then click the begin button. The interface shows like that in Figure 6-9.

Please go to Figure 6-2 to modify zoom, focus, and iris. Go back to Figure 6-9 and click end button.

You can memorise all these setups as pattern 1.



Figure 6-9

### 6.2.6 Activate Pattern Function

In Figure 6-6 input mode value in the No. blank, and then click pattern button.

### 6.2.7 Border Setup

In Figure 6-5, click the border button. The interface is shown as in Figure 6-10.

Please go to Figure 6-2, use direction arrows to select camera left limit, and then please go to Figure 6-10 and click left limit button

Repeat the above procedures to set right limit.



Figure 6-10

### 6.2.8 Activate Border Function

In Figure 6-6, click auto scan button, the system begins auto scan. Correspondingly, the auto scan button changes to stop button. Click stop button to terminate scan operation.

### 6.2.9 Flip

In Figure 6-6, click page switch button and you will see an interface as shown below. See Figure 6-11. Here you can set auxiliary function. Click the page switch button again and system goes back to Figure 6-2.



Figure 6-11



## 7 WEB CLIENT OPERATION

Please note: All the operations here are taking a 16-ch DVR as an example. There might be slight differences with the interface in different DVR series.

### 7.1 Network Connection

Before web client operation, please check the following items:

- Network connection is correct
- DVR and PC network setup is correct. Please refer to network setup (main menu->setting->network)
- Use order ping `***.***.***.***`(\* DVR IP address) to check connection is OK or not. Usually the return TTL value should be less than 255.
- System is compatible with WIN VISTA web control right now. But you need to disable user account control function. Double click user account and then disable user account control. After completing setup, please reboot the PC.
- System can automatically download latest web control and the new version can overwrite the previous one.
- If you want to un-install the web control, please run `uninstall web.bat`. Please note, before you un-install, please close all web pages, otherwise the un-installation might result in error.

### 7.2 Login

Open IE and input DVR address in the address column. For example, if your DVR IP is 10.10.3.16, then please input `http:// 10.10.3.16` in IE address column. See Figure 7-1

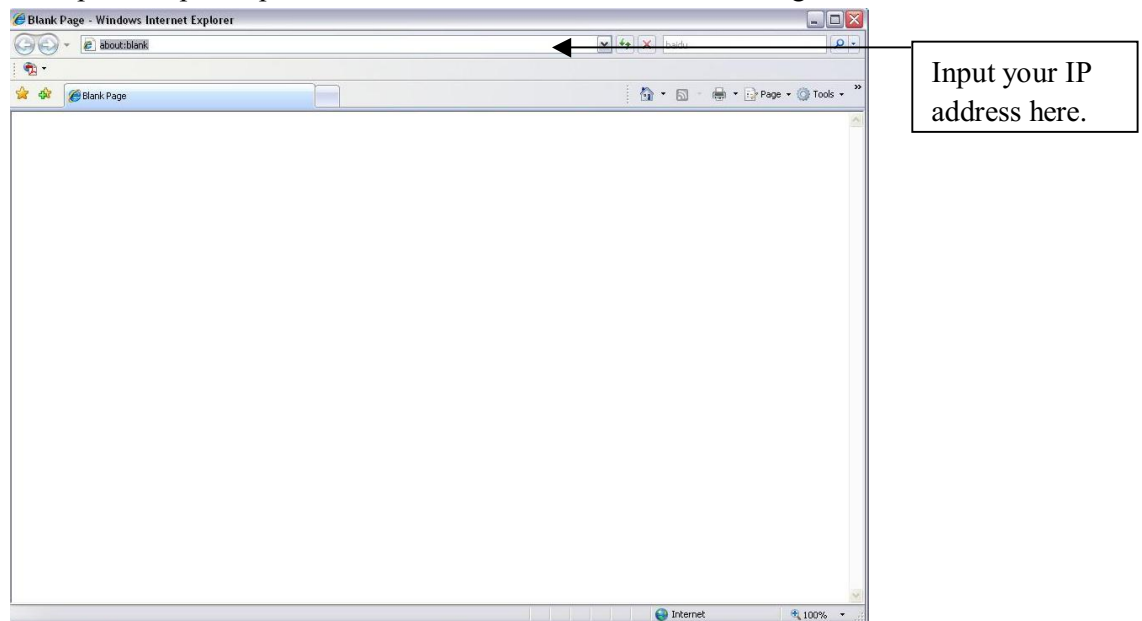

Figure 7-1

System displays warning information to ask you whether to install webrec.cab control or not. Please click yes button.  
If you can't download the ActiveX file, please modify your settings as follows. See Figure 7-2.

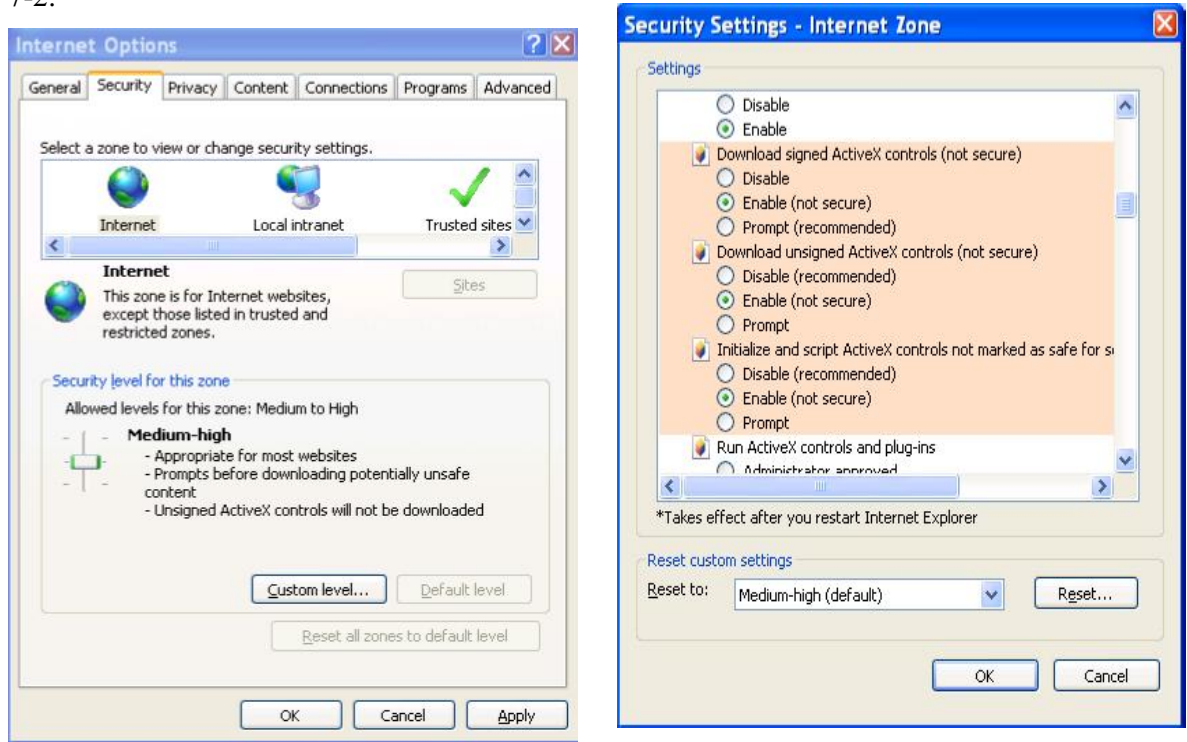

Figure 7-2

After installation, the interface is shown as below. See Figure 7-3.

Please input your user name and password.

Default factory name is admin and password is admin.

Note: For security reasons, please modify your password after you first login.

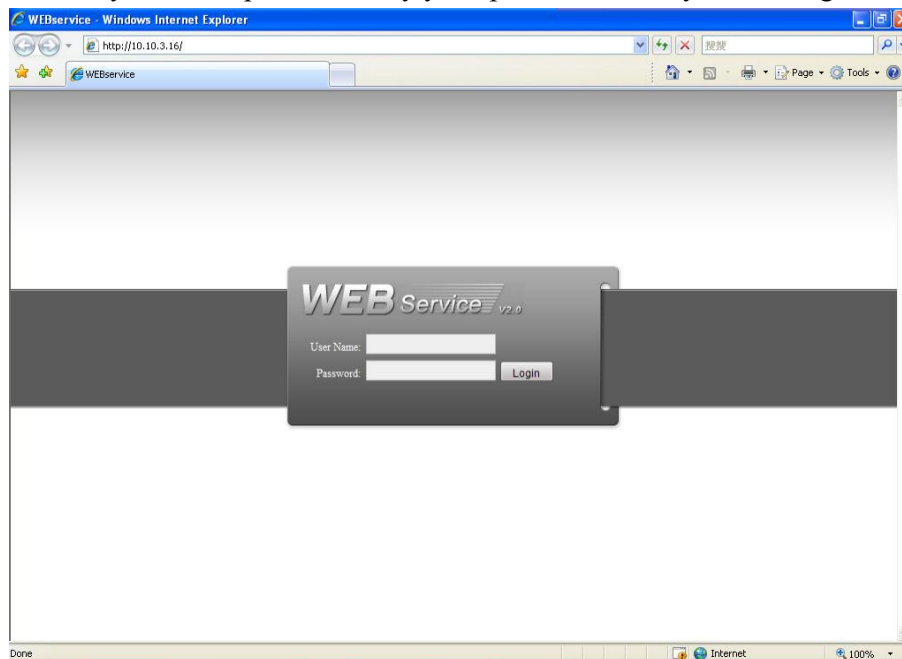

Figure 7-3

After you log in, you can see the main window. See fig. 7.6.

This main window can be divided into the following sections.

- Section 1: There are five function buttons: Configuration (chapter 7.3), Search (chapter 7.4), Alarm (chapter 7.5), About (chapter 7.6) and Log out (chapter 7.7).
- Section 2: There is channel number and three function buttons: Refresh, Start dialog and Local play.
- Section 3: There are PTZ (chapter 7.2.2), Colour (chapter 7.2.3) button and you can also select picture path and record path.
- Section 4: Real-time monitor window. Please note current preview window is circled by a green zone.
- Section 5: Here you can view window switch button. You can also select video priority between fluency or real-time.
  - ✧ System monitor window switch supports full screen/1-window/4-window/6-window/8-window/9-window/13-window/16-window/20-window/25-window/36-window. See Figure 7-4.



Figure 7-4

- ✧ Preview window switch. System support 1/4/8/9/16-window real-time preview. Please note you need to have the proper rights to implement the preview operation. You cannot preview if you have no rights to preview either channel. See Figure 7-5.



Figure 7-5

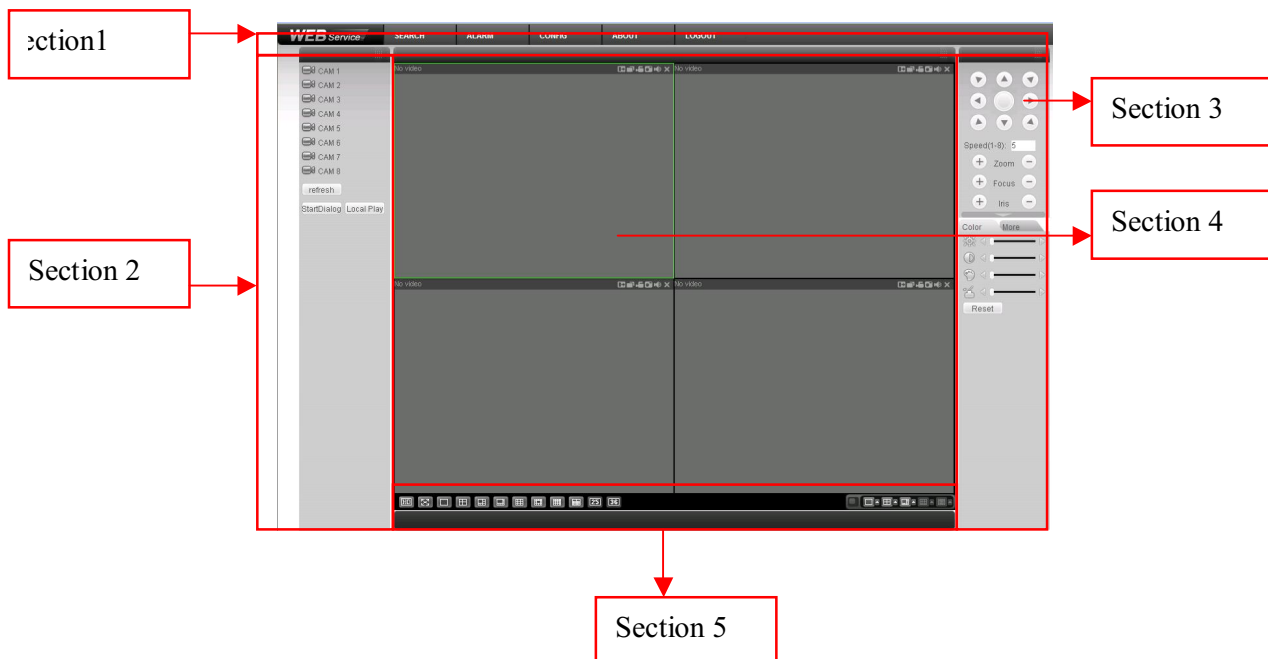

Figure 7-6

### 7.2.1 Real-time Monitor

In section 2, left click the channel name you want to view and you will see the corresponding video in current window.

For detailed function key information, please refer to Figure 7-7.

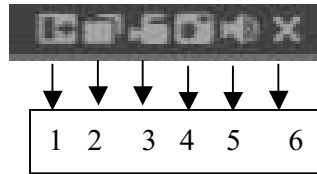

Figure 7-7

- 1: Digital zoom: Click this button and then left drag the mouse in the zone to zoom in. Right click mouse system restores original status.
- 2: Change show mode: Resize or switch to full screen mode.
- 3: Local record. When you click local record button, the system begins recording and this button becomes highlighted. You can go to system -.local record to set video file path.
- 4: Capture picture. You can snapshot important video. All images are memorised in system client folder \download\picture (default).
- 5: Audio :Turn on or off audio.(It has no relationship with system audio setup )
- 6: Close video.

Please refer to Figure 7-8 for main stream and extra stream switch information.

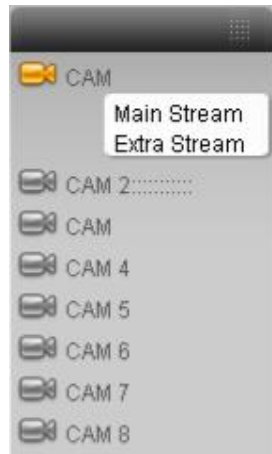

Figure 7-8

#### Refresh

You can use button to refresh camera list.

#### Start Dialogue

You can click this button to enable audio talk.

#### Local Play

Click local play button, system displays the following interface for you to select local play file. See Figure 7-9.



Figure 7-9

### 7.2.2 PTZ

Before PTZ operation, please make sure you have properly set PTZ protocol. (Please refer to chapter 7.3.2 Setting-> Pan/Tilt/Zoom).

Click PTZ button, the interface is shown in Figure 7-10 .

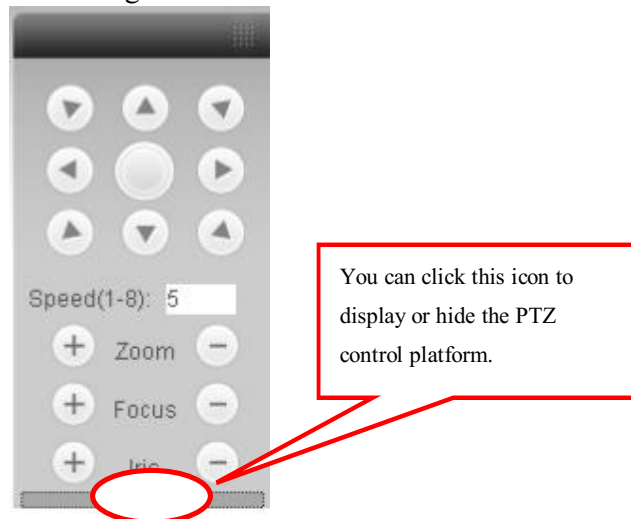

Figure 7-10

#### 7.2.2.1 Direction key and 3D positioning key

In Figure 7-10, there are eight direction keys.

In the middle of the eight direction keys, there is a 3D intelligent positioning key.







Click SIT button and system goes back to the single screen mode. Drag the mouse in the screen to adjust section size. It can connect PTZ automatically.

#### 7.2.2.2 Speed

System supports eight-level speed. You can select from the dropdown list. Speed 2 is faster than speed 1.

### 7.2.2.3 Zoom/Focus/Iris

Here is a guide for you reference.

Name	Function key	Function	Function key	Function
Zoom		Near		Far
Focus		Near		Far
Iris		close		Open

Then click triangle icon in Figure 7-10 and you will see the following interface. See Figure 7-11.

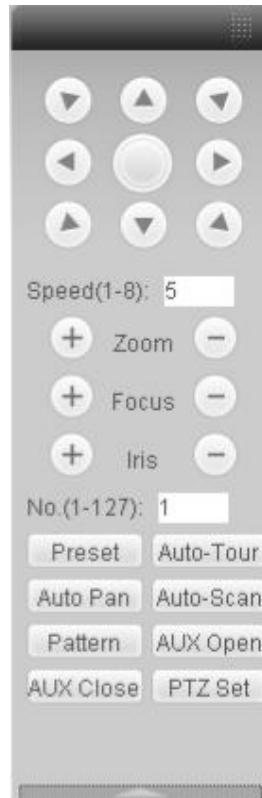

Figure 7-11

In Figure 7-11, click PTZ setup button you can see the following interface. See Figure 7-12.

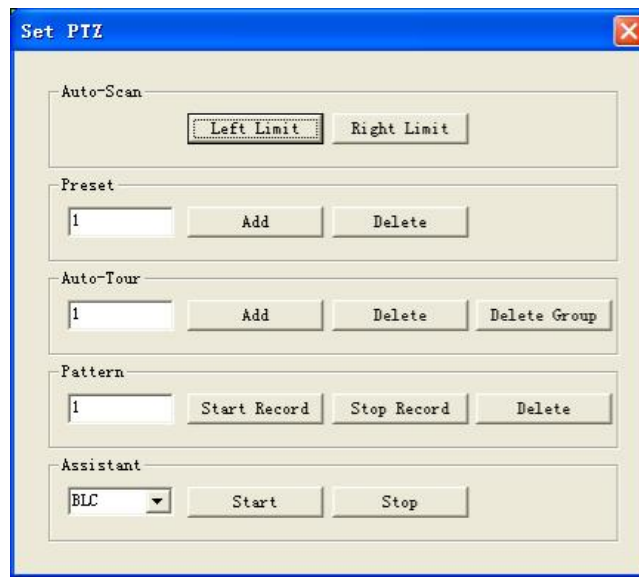

Figure 7-12

#### 7.2.2.4 Auto Scan

In Figure 7-12, move the camera to your desired location and then click left limit button. Then move the camera again and then click right limit button to set a right limit.

#### 7.2.2.5 Pattern

In Figure 7-12, you can input pattern value and then click start record button to begin PTZ movement. Please go back to Figure 7-11 to implement camera operation. Then you can click stop record button. Now you have set one pattern.

#### 7.2.2.6 Preset

In Figure 7-12, move the camera to your desired location and then input preset value. Click add button, you have set one preset.

#### 7.2.2.7 Auto tour

In Figure 7-12, input auto tour value and preset value. Click add button and you have added one preset in the tour.

Repeat the above procedures to add more presets in a tour.

#### 7.2.2.8 Assistant

You can select the assistant item from the dropdown list. See Figure 7-13.

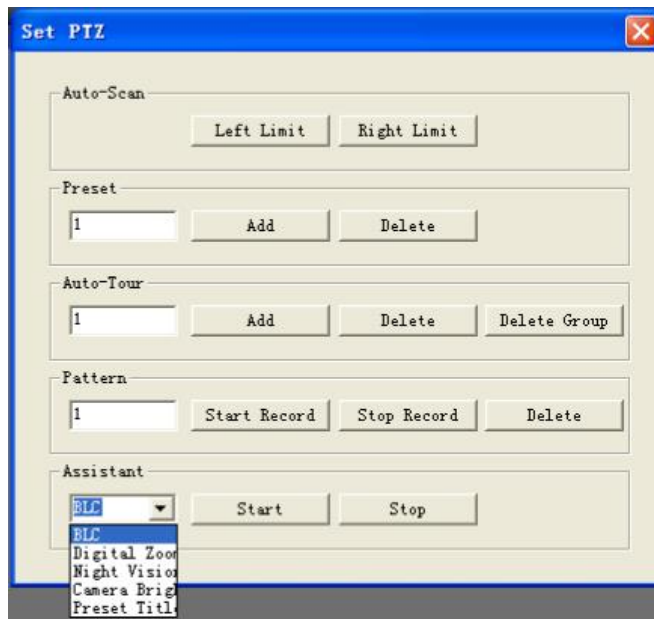

Figure 7-13

### 7.2.3 Colour

Click colour button in section 3, the interface is shown in Figure 7-14.

Here you can select one channel and then adjust its brightness, contrast, hue and saturation. (Current channel border becomes green).

Alternatively you can click default button to use system default setup.

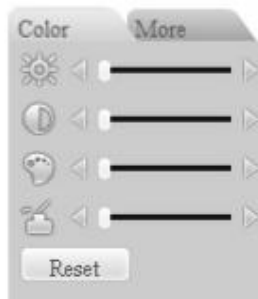

Figure 7-14

### 7.2.4 Picture Path and Record Path

Click more button in Figure 7-14, you can see an interface is shown as in Figure 7-15.

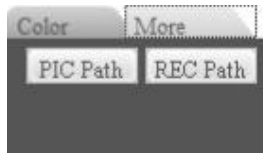

Figure 7-15

Click picture path button and you will see an interface as shown in Figure 7-16.



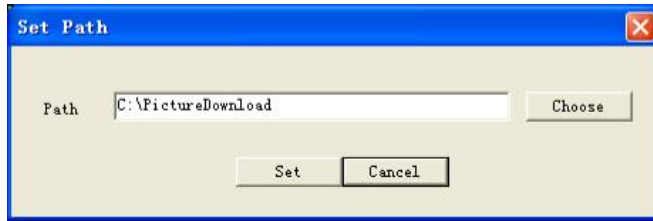

Figure 7-16

Click record path button and you will see an interface as shown in Figure 7-17.

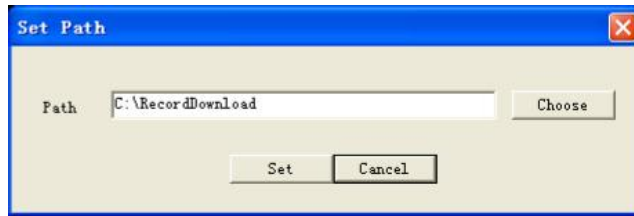

Figure 7-17

### 7.2.5 Menu Interface Switch

Put your mouse on the PTZ control bar until you see the following icon. See Figure 7-18.



Figure 7-18

Left click your mouse and then drag it to the channel control status bar. You can see the two menus interface switched. See Figure 7-19. You can compare the following interface with Figure 7-6.



Figure 7-19

## 7.3 Configure

In the main window, click the Config button to see interface shown in Figure 7-20.

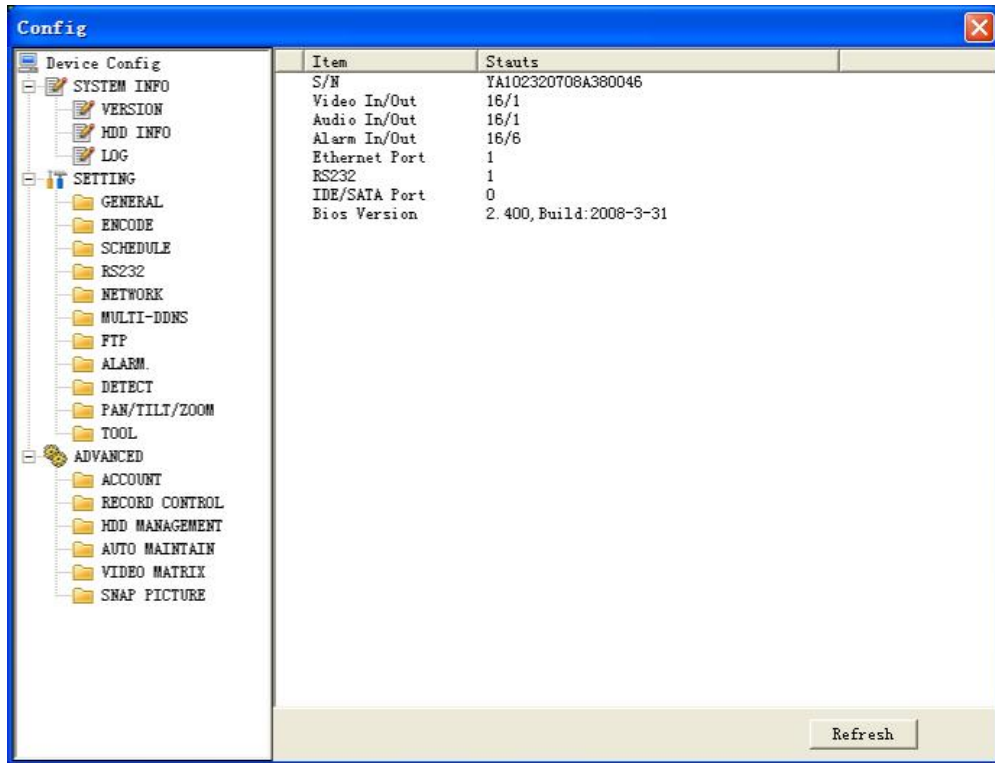

Figure 7-20

### 7.3.1 System Information

Click device configuration button to see the following interface. See Figure 7-21.

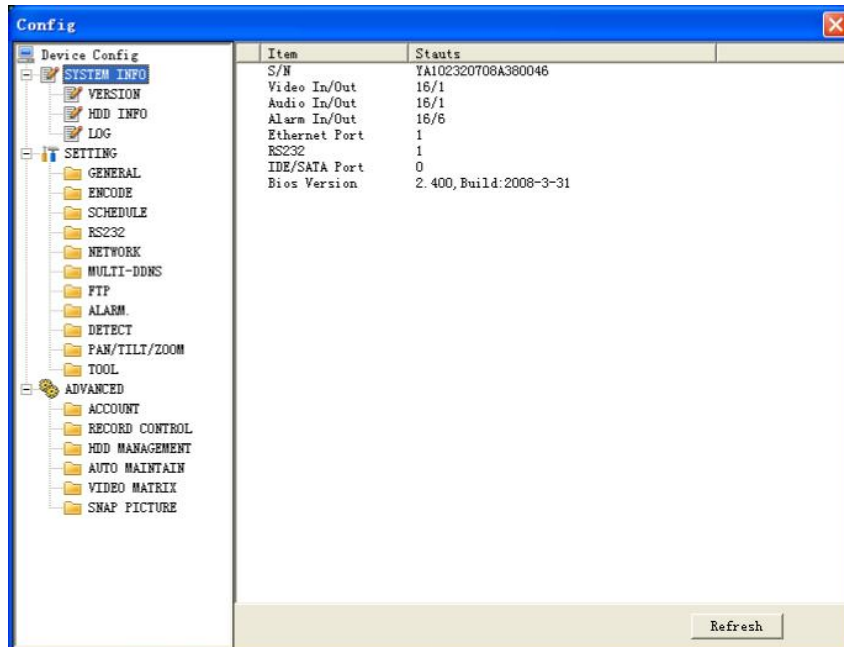

Figure 7-21

- **Version**

Click version button, you can see corresponding HDD information for your reference. See Figure 7-22.

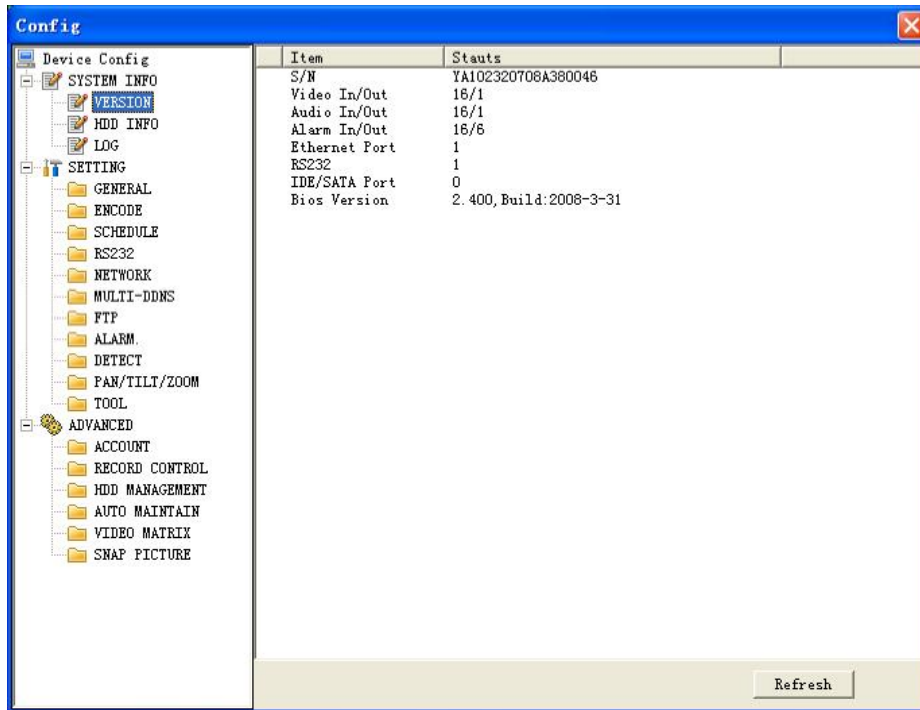

Figure 7-22

- **HDD Information**

Here you can view HDD number, HDD status, total volume and free space. See Figure 7-23.

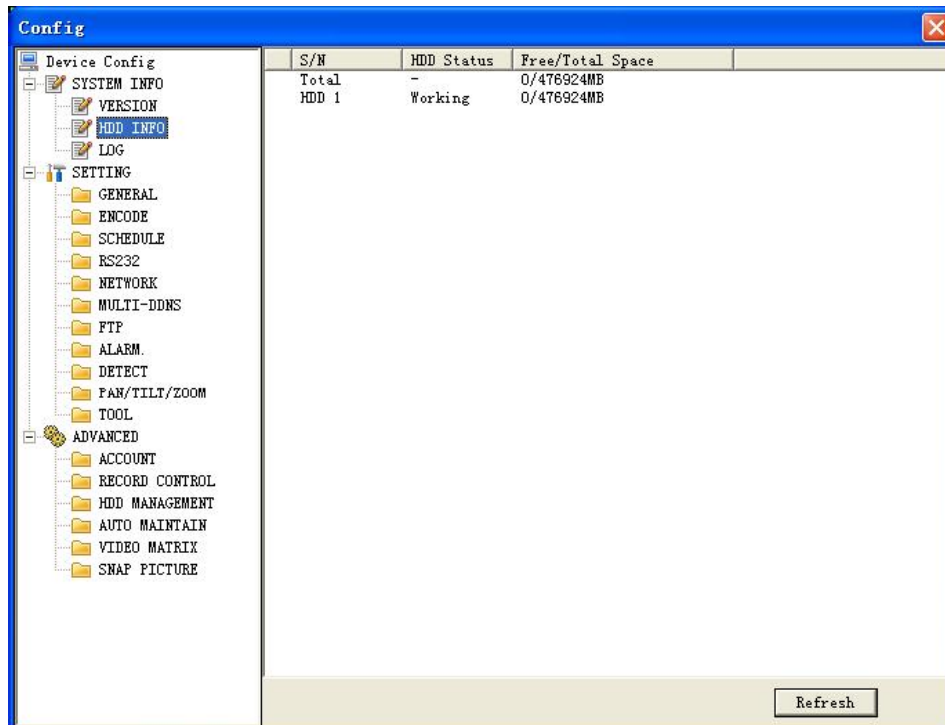

Figure 7-23

- **Log**

Click log button to see an interface is shown as in Figure 7-24. Here you can view current device log information.

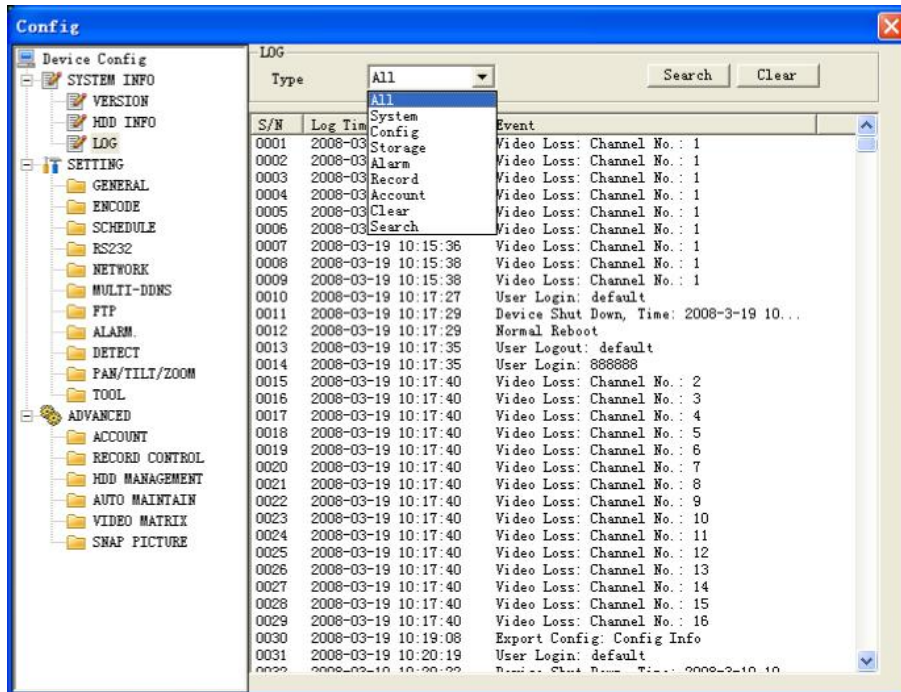

Figure 7-24

### 7.3.2 Setting

Setting includes the following items:

- ◇ General
- ◇ Encode setup
- ◇ Schedule
- ◇ RS232
- ◇ Network
- ◇ MUL-DDNS
- ◇ FTP
- ◇ Alarm setup
- ◇ Detect
- ◇ Pan/Tilt/Zoom
- ◇ Tool
- ◇

Please note: setups for different device series may vary. Please refer to the corresponding user's manual.

- **General**

General interface is shown in Figure 7-25.

- ◇ System time: Enter system time and click Save after your modification
- ◇ Date format: Select date format from the dropdown list.
- ◇ Date separator: Please select separator such as – or /.
- ◇ Time format: There are two options: 24-H and 12-H.

- ✧ HDD full: There are two options: Stop Recording or Overwrite the previous files when HDD is full.
- ✧ Pack duration: Select file size. Default setup is 60 minutes. Recommend 15 minutes.
- ✧ Device No.: When you are using one remote control to manage multiple DVRs, you can give these DVRs serial numbers respectively. Click address button in your remote control and then input the correct device number, now you can control the DVR.
- ✧ Video standard: PAL. (for your reference only)

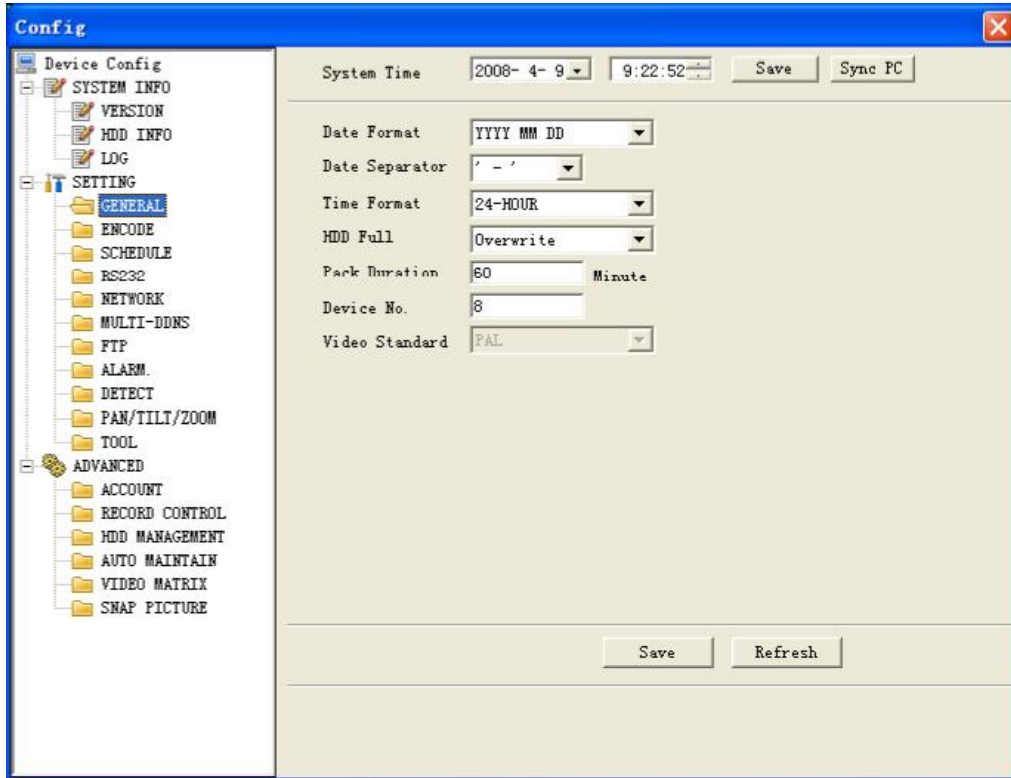

Figure 7-25

### ● Encode

Encode setup includes the following items. See Figure 7-26.

Here you can select

- ✧ Channel: Select a channel.
- ✧ Channel name: Modify channel name.
- ✧ Data stream: Regular and extra data stream.
- ✧ VA enable: Video/Audio. System only displays video by default. You need to manually enable audio function.
- ✧ Bit rate: There are two options: CBR and VBR. You can only set video quality in VBR mode.
- ✧ Frame rate: The value ranges from 1f/s to 25f/s (PAL) and 1f/s to 30f/s (NTSC).
- ✧ Compression: There are two options: H.264 and MPEG 4.
- ✧ Resolution: D1/HD1/DCIF/CIF
- ✧ Quality: The value ranges from 1 to 6. Level 6 is the best video quality.

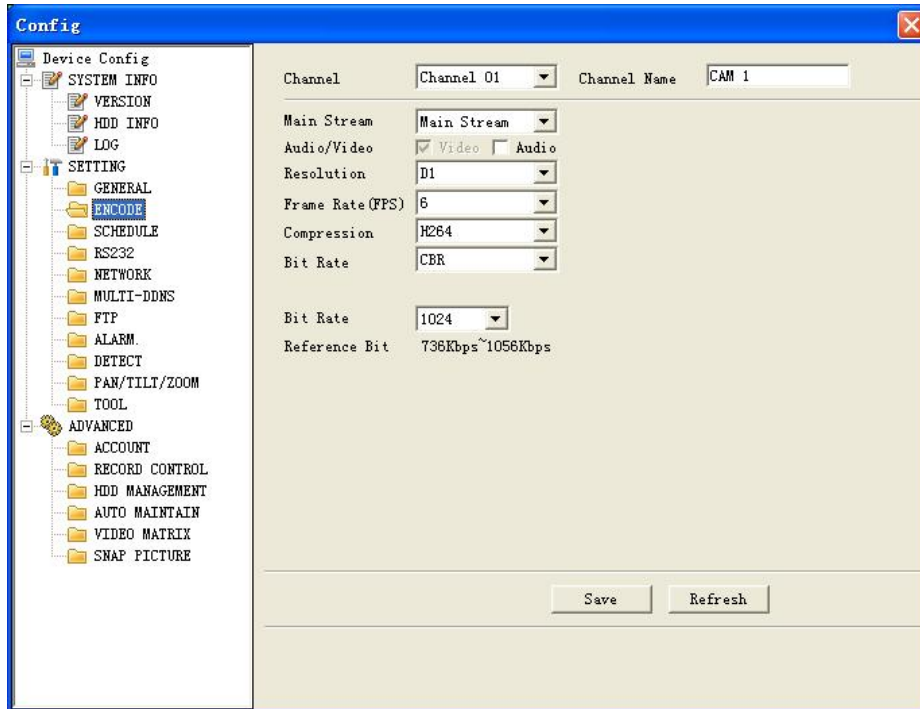

Figure 7-26

- **Schedule**

Schedule includes the following interface. See Figure 7-27.

When DVR boots up, it is in 24-hour continuous record. In this interface you can set record type, record time and period. Record type includes regular record(R), motion detection record (M) and alarm record (A).

- ✧ Channel: Select the channel number you desire.
- ✧ Week: You can select from the dropdown list or at the bottom of the interface.
- ✧ Prerecord: System can record the three to five seconds video before activating the record operation into the file.(Depends on data size)
- ✧ Period: There are six periods for you to set. Please click set button of the corresponding period. See Figure 7-28.Please note all the setup here shall be in one day. E.g. 00.00 to 24.00.

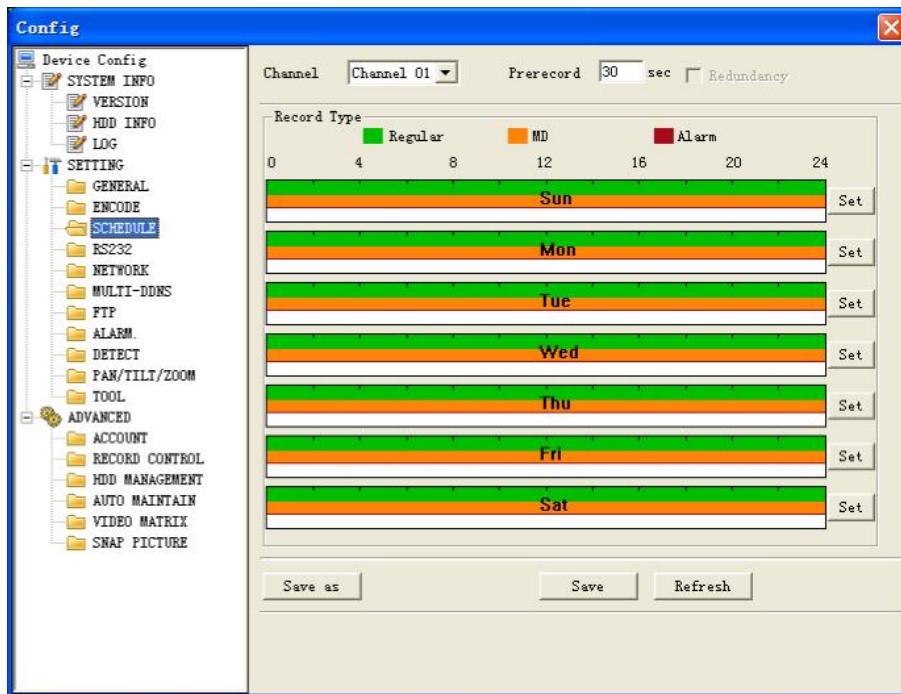

Figure 7-27

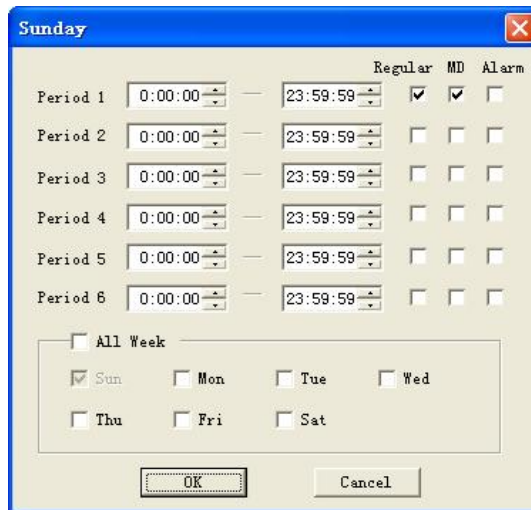

Figure 7-28

**Tip:**

After you finish setup for one channel, you can click “save as” button and system displays the following interface. See Figure 7-29. Now you can copy one channel setup to other channels.



Figure 7-29

- **Network**

Network interface is shown as in Figure 7-30.

This interface includes the following items:

**Max:** Here you can set max connections. The value ranges from 0 to 10.

0 means no network connection is allowed.

**TCP port:** Default setup is 37777. Please note port 37778 is for network UDP port use only.

**HTTP port:** Default setup is 80.

**Transfer:** Select priority between fluency/video quality.

- ◇ **Enable PPPoE**

In remote item, enable PPPoE function and then input “PPPoE name” and “PPPoE password” you get from your ISP (Internet service provider). See Figure 7-30.

Now Click save button and you will need to restart to activate your configuration.

After rebooting, DVR will connect to Internet automatically. The IP displayed in the IP address item is the dynamic value. You can use client-end software to visit current IP now.

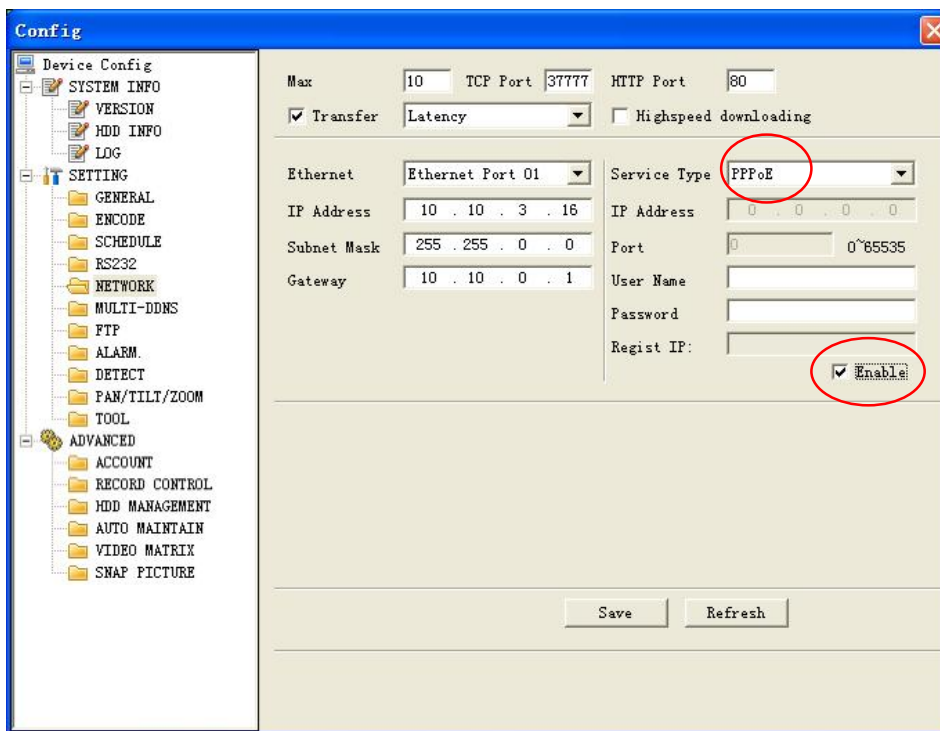

Figure 7-30

- ◇ **Enable DDNS**

You need a PC of fixed IP on the Internet and DDNS software is running in this PC. In other words, this PC is a DNS (domain name server).see Figure 7-31.

Please enable DDNS function and then input PC IP. Click save button and then reboot device.

Now you can login via DDNS. Please open IE and then input http //(DDNS server IP)/ DDNServer / default.htm. for example, input http //10.5.2.149/DDNServer/default.htm to open a DDNS server web page.



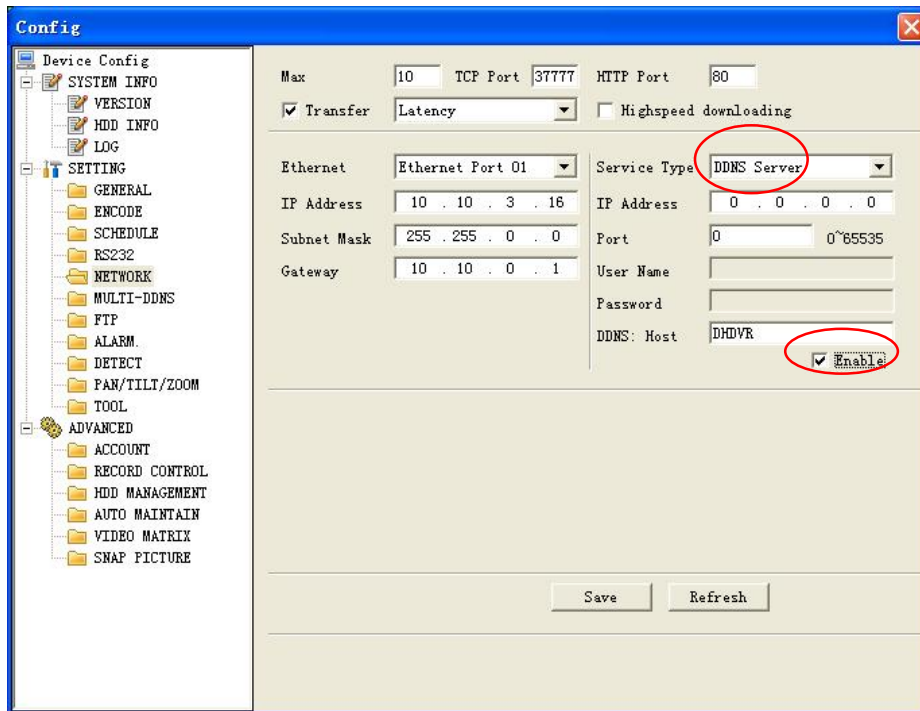

Figure 7-31

● **RS232**

RS232 includes the following items. See Figure 7-32.

**SPECIAL NOTE: RS232 IS NOT SUPPORTED**

- ✧ Function: There are various devices for you to select. Console is for serial port or min-end platform to upgrade program. Keyboard is for you to use special keyboard to control current device.
- ✧ Baud rate: Select appropriate baud rate.
- ✧ Data bit: The value ranges from 5 to 8.
- ✧ Stop bit: There are three options: 1, 1.5 and 2.
- ✧ Parity: There are three options: none, odd and even.

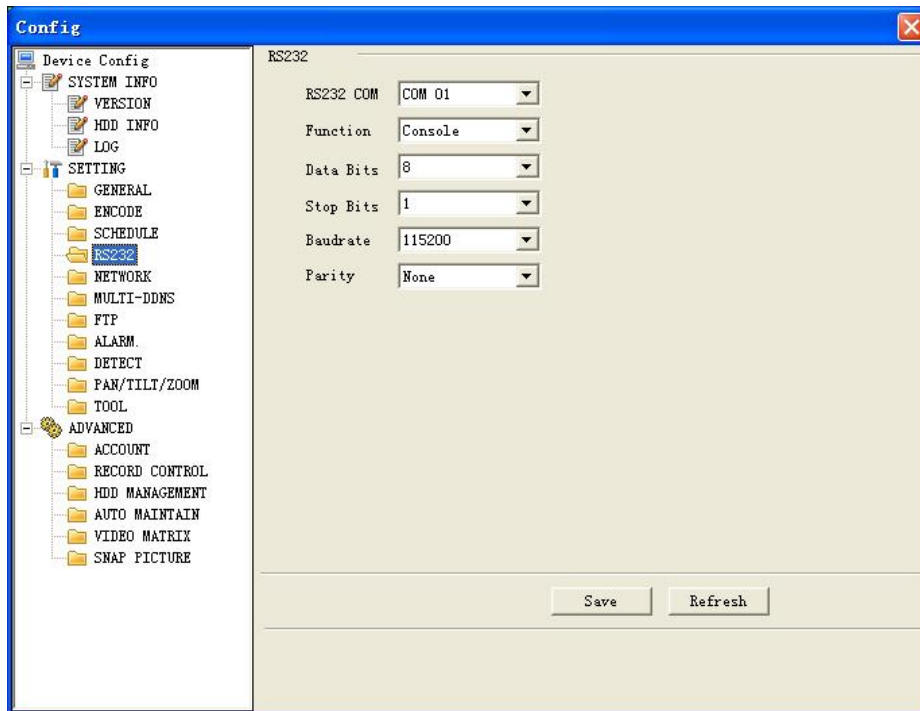

Figure 7-32

- Mul-DDNS

Here you can select DDNS type. This operation needs DVR device support. See Figure 7-33.

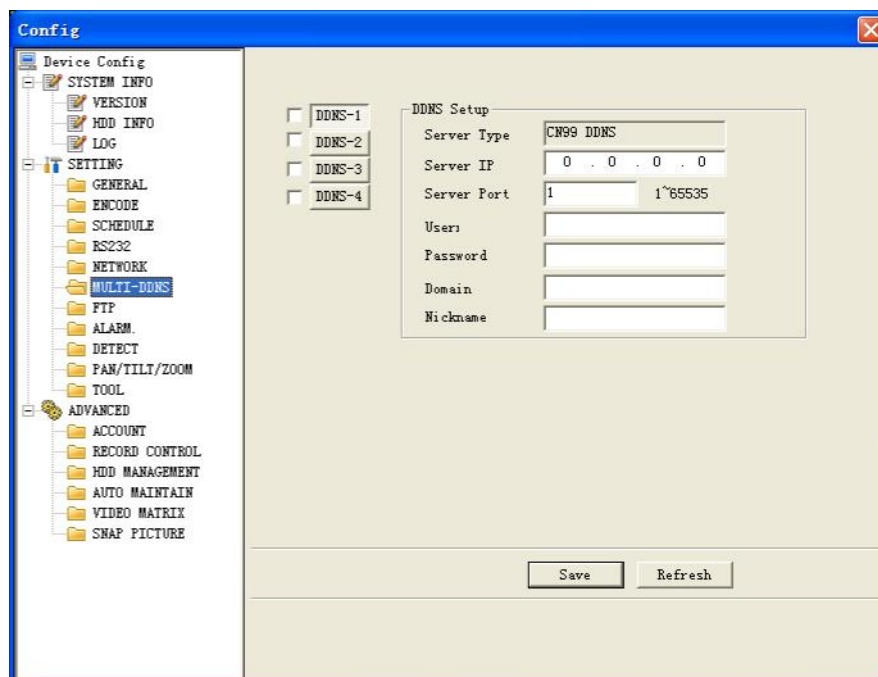

Figure 7-33

- **FTP**

This option allows you to send alarm triggered video to a specified IP address using FTP. After you complete setup, system uploads scheduled data to the specified FTP server.

In Figure 7-34, you need to input FTP server address, port (default = 21), login username and password. Then you need to specify the destination directory to save the files.

- **File Size:** Input uploaded file length (Unit: MB). If the file is smaller than the setup value, the system uploads the whole file. If the file is larger than the setup value, the system only uploads the setup value data and ignores the rest.
- **Interval:** For one channel of the same record type, if there is more than one alarm, the system only uploads the first file. For example, if the interval is five minutes, then the system only uploads the first alarm or motion detection file even though there are several alarms in five minutes. If the setup is 0, then the system uploads all files.
- **Time period:** Click set button to display interface as in Figure 7-35. You can check the box to select the file type. System supports multiple choices.

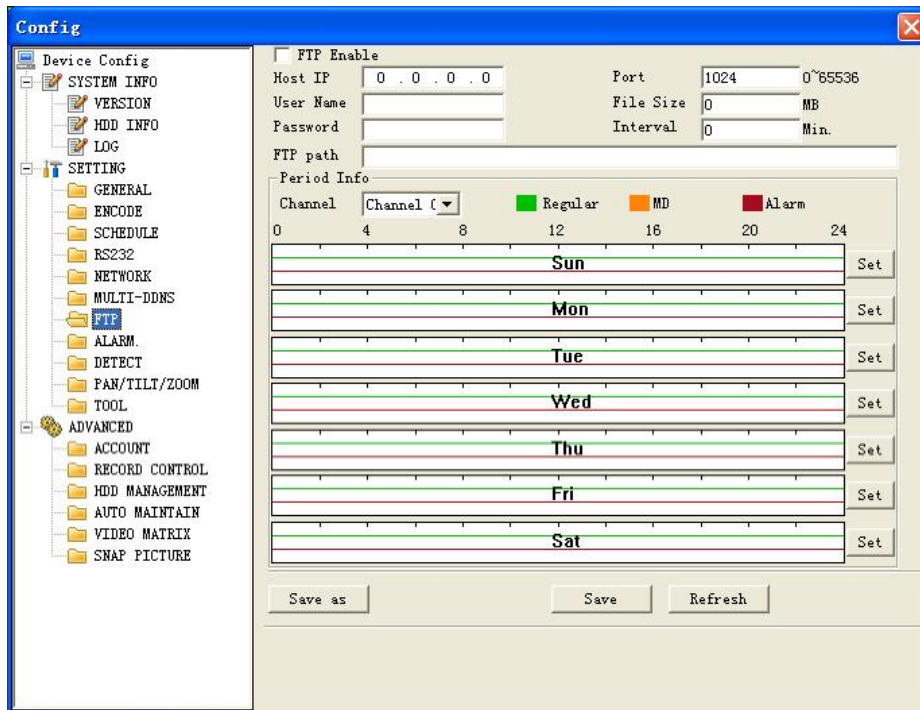

Figure 7-34

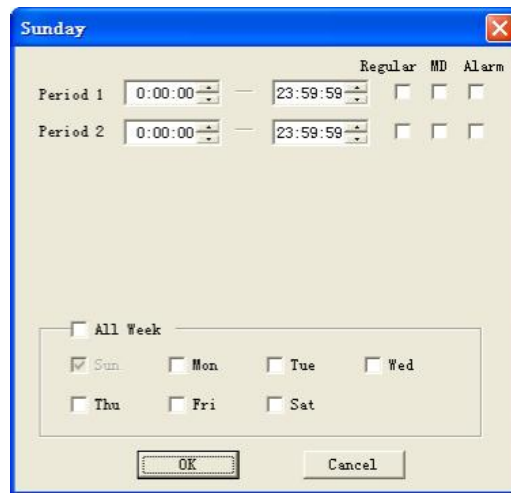

Figure 7-35

● **Alarm**

Please note before setting alarm setup, you need to properly connect alarm input and output device, and send and receive address. Then click the save button to confirm current setup. Alarm setup includes the following items. See Figure 7-36.

- ✧ **Event Type:** you can select event type from the drop down list: Local alarm/Net alarm.
- ✧ **Alarm in:** Select corresponding alarm channel
- ✧ **Type:** There are two options: normally open and normally closed.
- ✧ **Record channel:** Select record channel when alarm occurs. Please note you need to select alarm record in DVR schedule interface and enable schedule function in manual record interface.
- ✧ **Alarm output:** Select alarm activation channel when alarm occurs. Please note alarm channel 3 controls +12V output.
- ✧ **Show message:** System can display a message to alarm you in the local host screen if you enabled this function.
- ✧ **Email:** System can send out an Email to alert you when alarm occurs.
- ✧ **PTZ activation:** Here you can set PTZ movement when alarm occurs. Such as go to preset x when there is an alarm. Click set button to display interface shown in Figure 7-37.
- ✧ **Tour:** Here you can enable tour function when alarm occurs. System supports multiple-window tour. Please go to chapter 5.3.9 Display for tour interval setup.

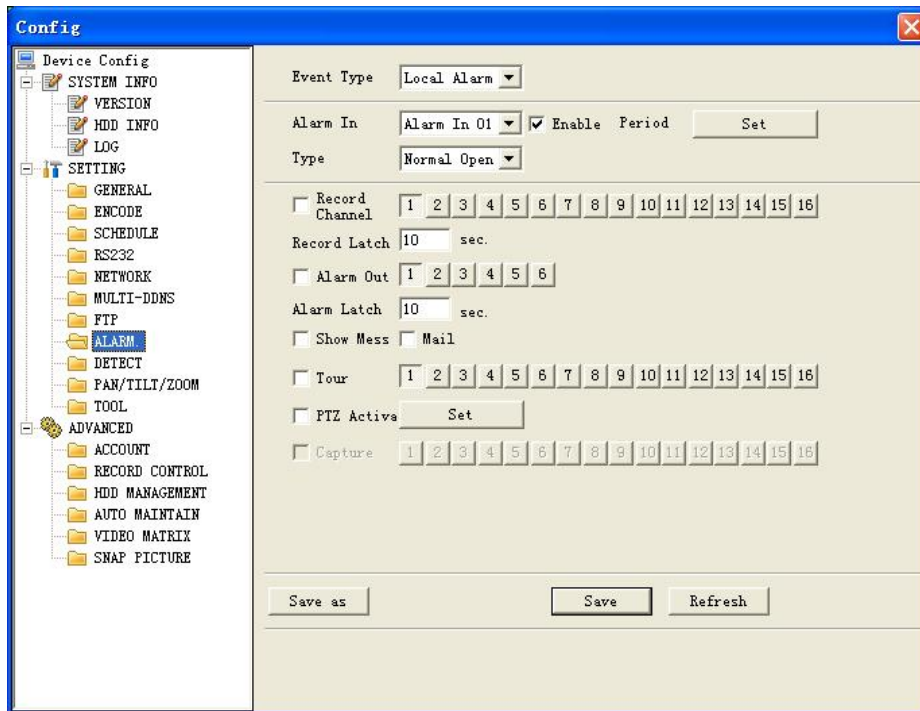

Figure 7-36



Figure 7-37

● **Detect**

Detect interface is shown as in Figure 7-38.

It includes the following items:

- ✧ **Channel:** Select channel name from the dropdown list.
- ✧ **Type:** There are three types: motion detection/Video loss/Camera mask detection.
- ✧ **Record channel:** Select record channel (Multiple choices). Please make sure you have set MD record in encode interface (Main Menu->Setting->Schedule) and schedule record in manual record interface (Main Menu->Advanced->Manual Record)
- ✧ **Period:** This is where you set record period. Click set button to display interface as shown in Figure 7-39. In Figure 7-39, click time set button to display interface as shown in Figure 7-40. Here you set time period.

- ✧ **Sensitivity:** There are six levels. The sixth level has the highest sensitivity.
- ✧ **Region:** If you select motion detection type, you can click this button to set motion detection zone. The interface is shown in Figure 7-41. There are 192 zones (16\*12). Right click mouse you can go to full-screen display mode. Do remember clicking OK button in Figure 7-41 to save your motion detection zone setup.
- ✧ **Alarm output:** Here you can select activated external peripheral device when alarm occurs.
- ✧ **Show message:** System can alert you on the local screen if you enabled this function.
- ✧ **Mail:** System can send out an Email to alert you when alarm occurs.
- ✧ **Tour:** Enable tour function when alarm occurs in corresponding channel. System supports multiple-window tour. Please go to chapter 5.3.9 Display for tour interval setup.
- ✧ **PTZ activation:** Click set button to display interface as shown in Figure 7-42. System can go to corresponding preset when alarm occurs.

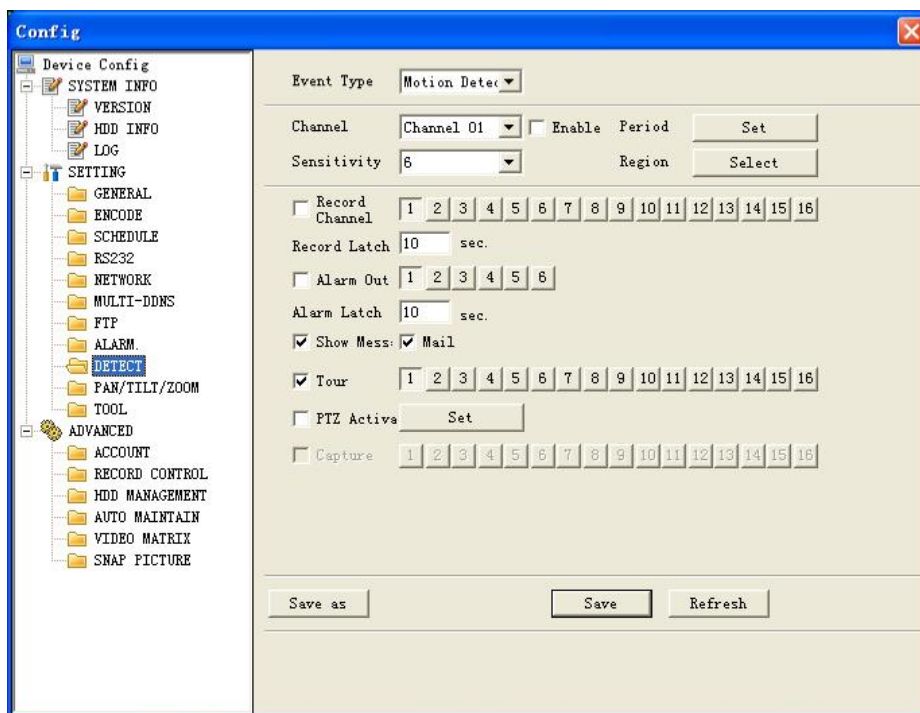

Figure 7-38

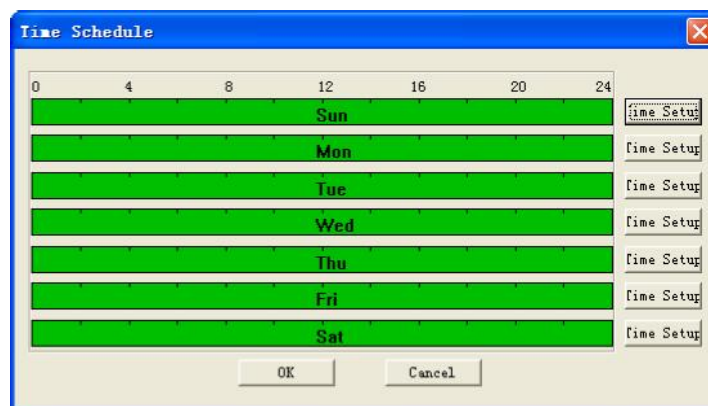

Figure 7-39

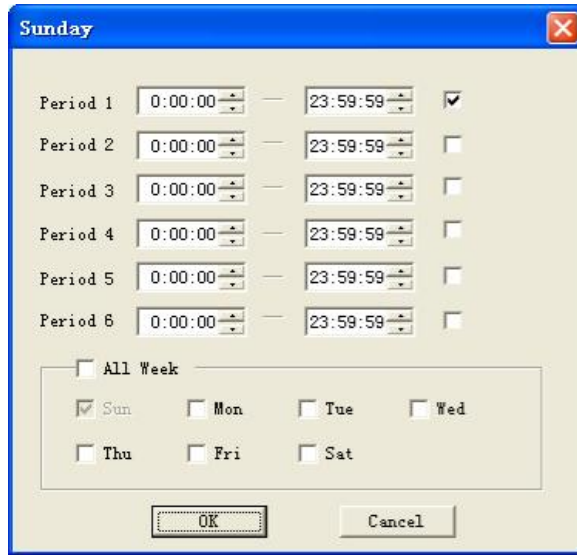

Figure 7-40

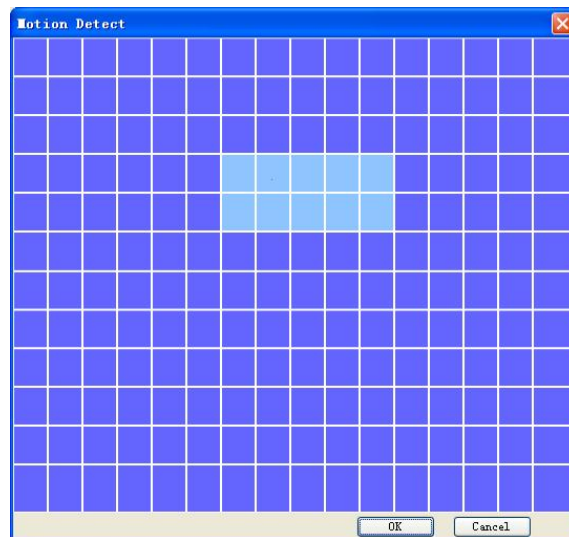

Figure 7-41



Figure 7-42

- **Pan/Tilt/Zoom**

Pan/Tilt/Zoom interface is shown in Figure 7-43.

Please note you have properly set dome address and all connections are correct.

- ◇ **Decoder:** Select the dome connected channel.
- ◇ **Protocol:** Select the corresponding dome protocol.(such as PelcoD)
- ◇ **Address:** Set corresponding dome address. Default value is 1. Please note your setup must agree with your dome address; otherwise you can not control the speed dome.
- ◇ **Baud rate:** Select the dome baud rate. Set to 2400 for PELCO-D.
- ◇ **Data bit:** Default setup is 8.
- ◇ **Stop bit:** Default setup is 1.
- ◇ **Parity:** Default setup is none.

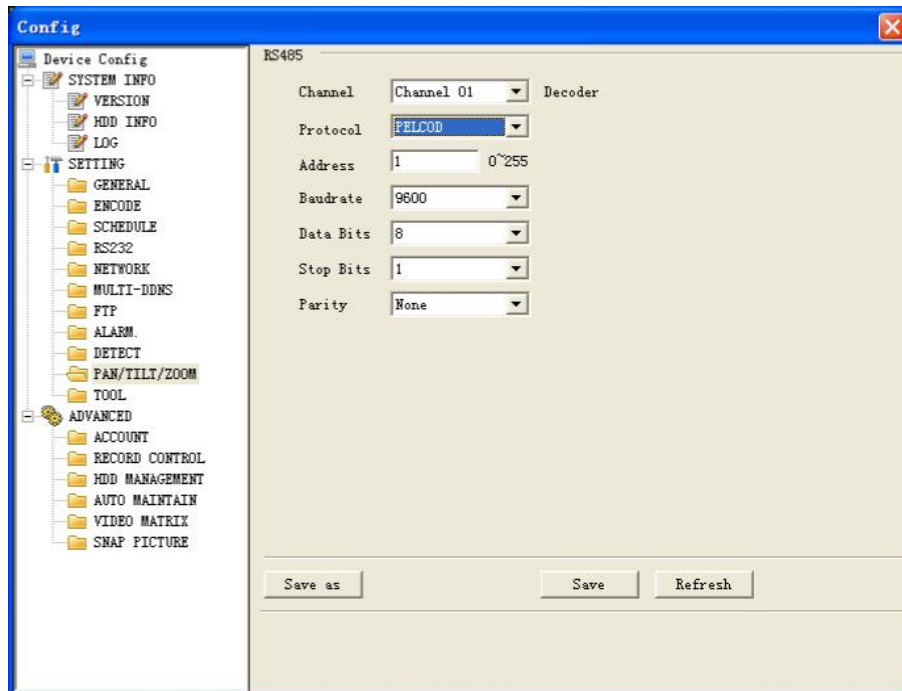

Figure 7-43

- **Tool**

Here you can export or import configuration information. See Figure 7-44.

**Save configuration data:** Click export config button to save current setup as a file. Extension name is CFG. See Figure 7-45.

**Load configuration data:** Click import config button to load a setup file.



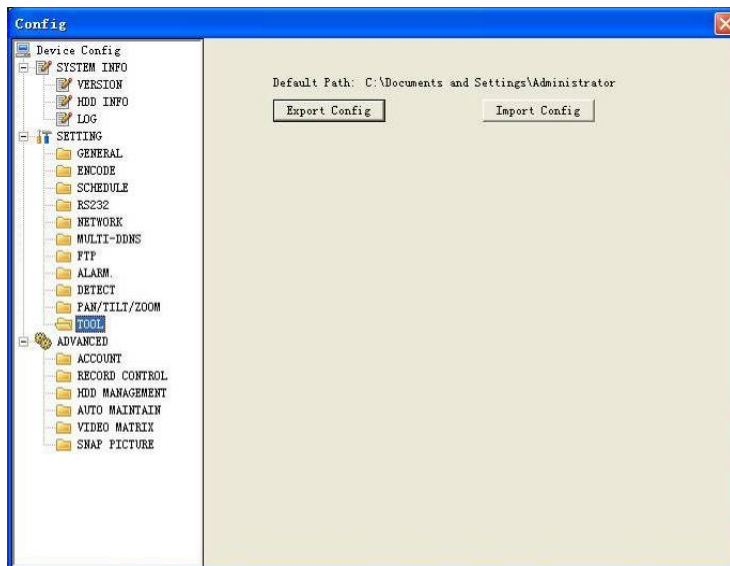

Figure 7-44

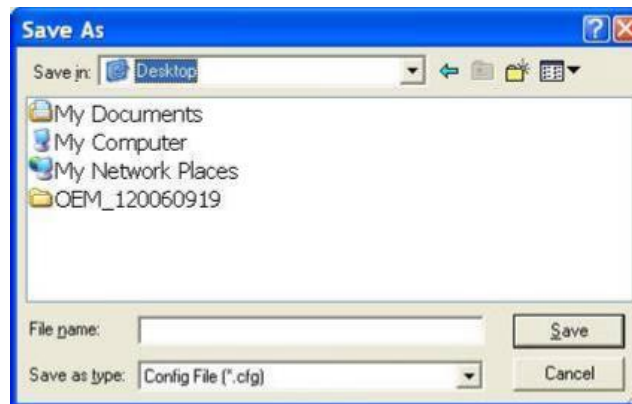

Figure 7-45

### 7.3.2.1 Advanced

Advanced includes the following items. See Figure 7-46.

- ✧ Account
- ✧ HDD management
- ✧ Alarm input
- ✧ Alarm output
- ✧ Auto maintain
- ✧ Video matrix
- ✧ Snapshot

- **Account**

Account interface is shown as in Figure 7-46. Here you can add/delete user, add/delete group, modify user or group right, modify user password.

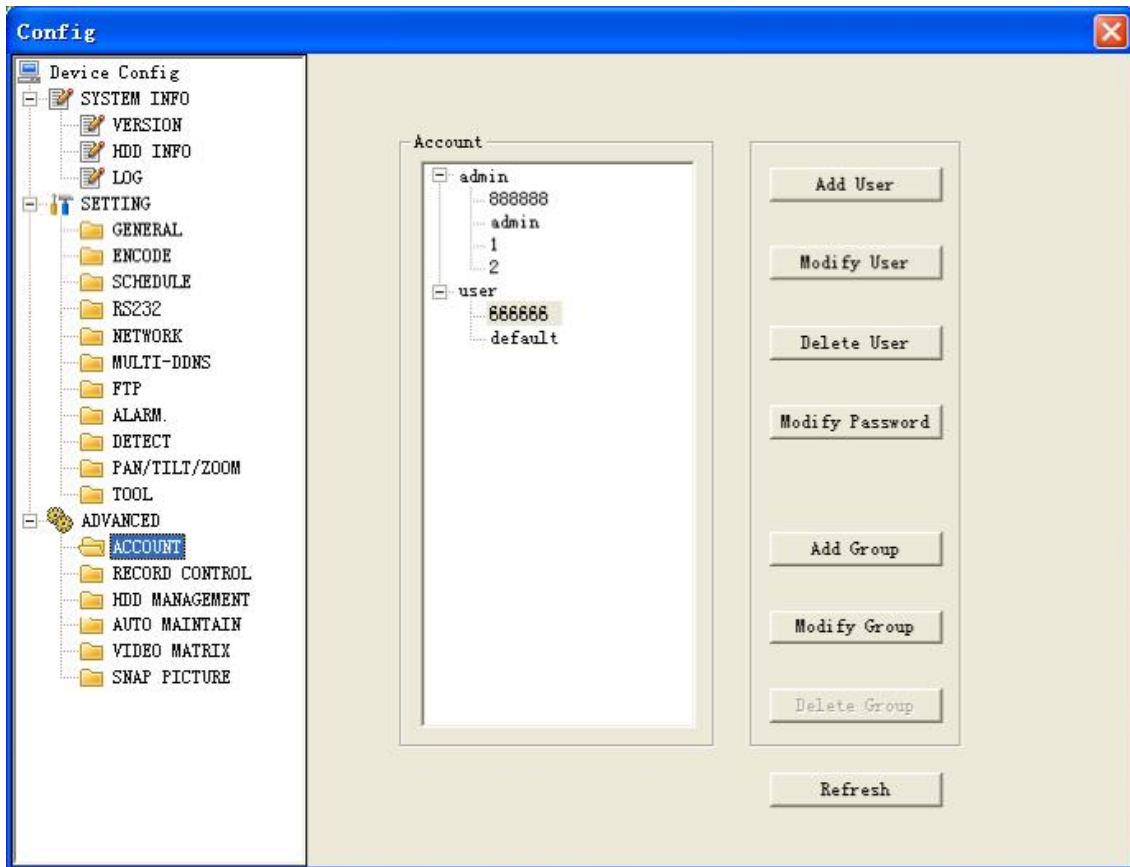

Figure 7-46

Click add group button, you can see the following interface. See Figure 7-47. Here you can add one new group, and then select corresponding rights for the whole group accounts.

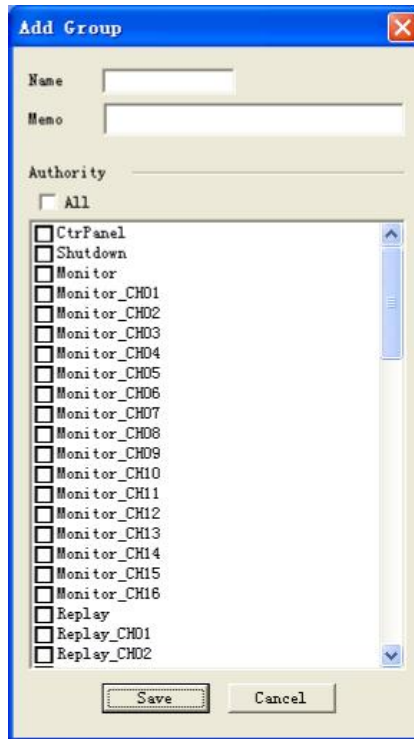

Figure 7-47

Click add user button to display the following interface. See 7-48  
Here you can input a new user and then select corresponding rights.  
Please note one user must belong to one group and user rights cannot exceed the group rights  
limit.

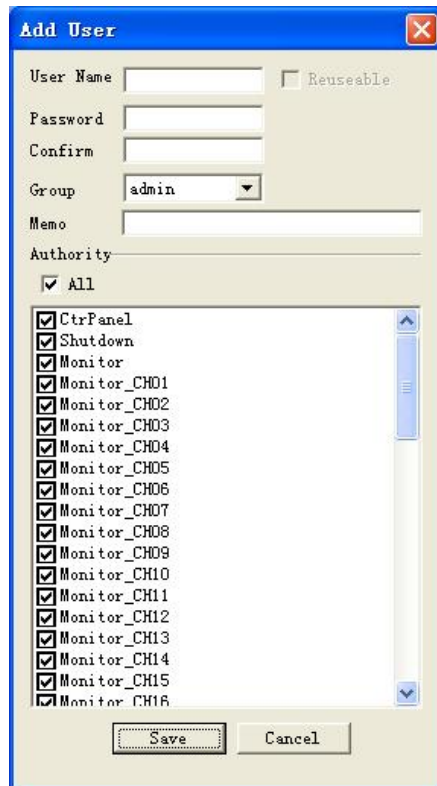

Figure 7-49

- **Record Control**

Record control interface is shown as in Figure 7-50.

**Record control:** Enable record status for corresponding channel.

**Alarm output channel:** Here you can select alarm output channel. DVR output channel can not support large overload. (It must be less than 1A). Too heavy current may result in relay damage.

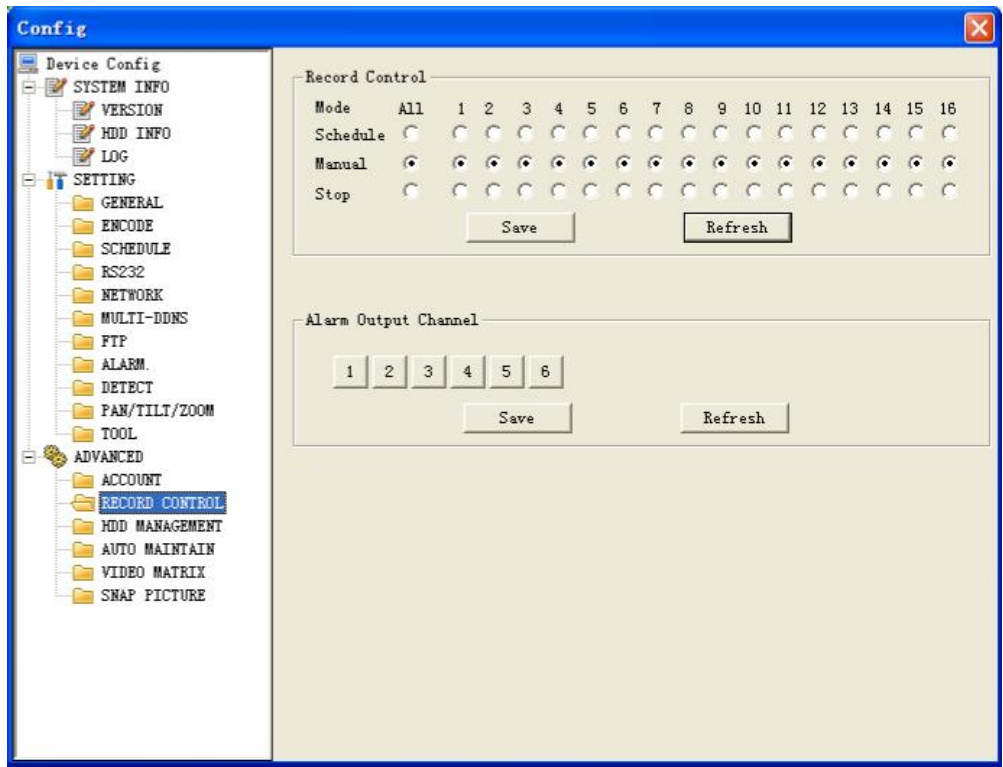

Figure 7-50

- **HDD management**

Please select the HDD first and then you can see the items on your right become valid. You can check the corresponding item here. See Figure 7-51.

After you completed setup, please click control HDD button to restart the DVR.

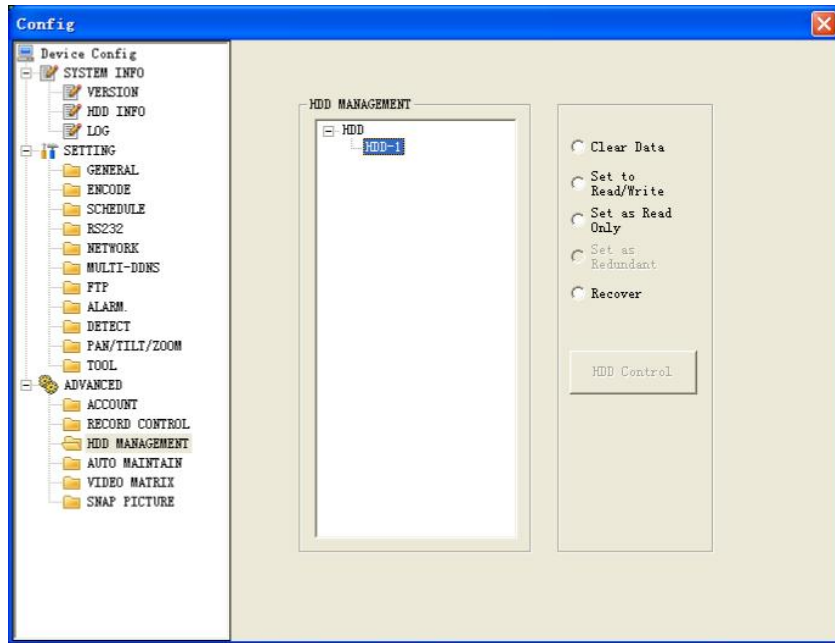

Figure 7-51

- **Auto maintenance**

Auto maintenance interface is shown as in Figure 7-52. Here you can enable auto reboot or auto delete old files function.

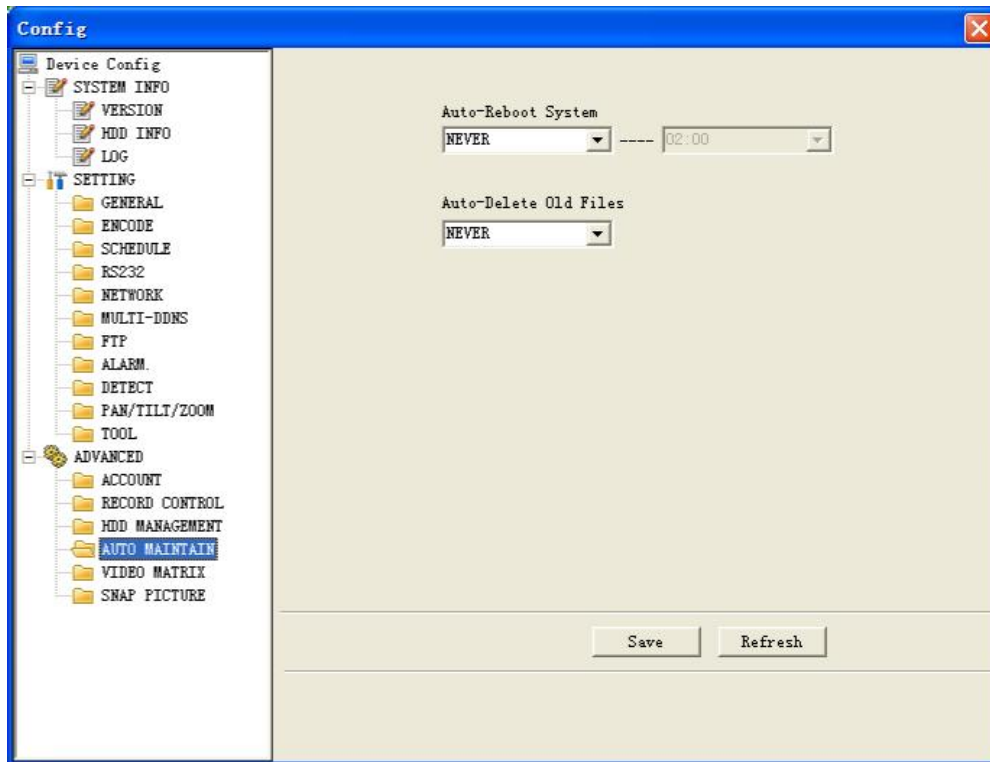

Figure 7-52

- **Video Matrix**

Video matrix interface is shown in Figure 7-53. Please note this function depends on DVR available features.

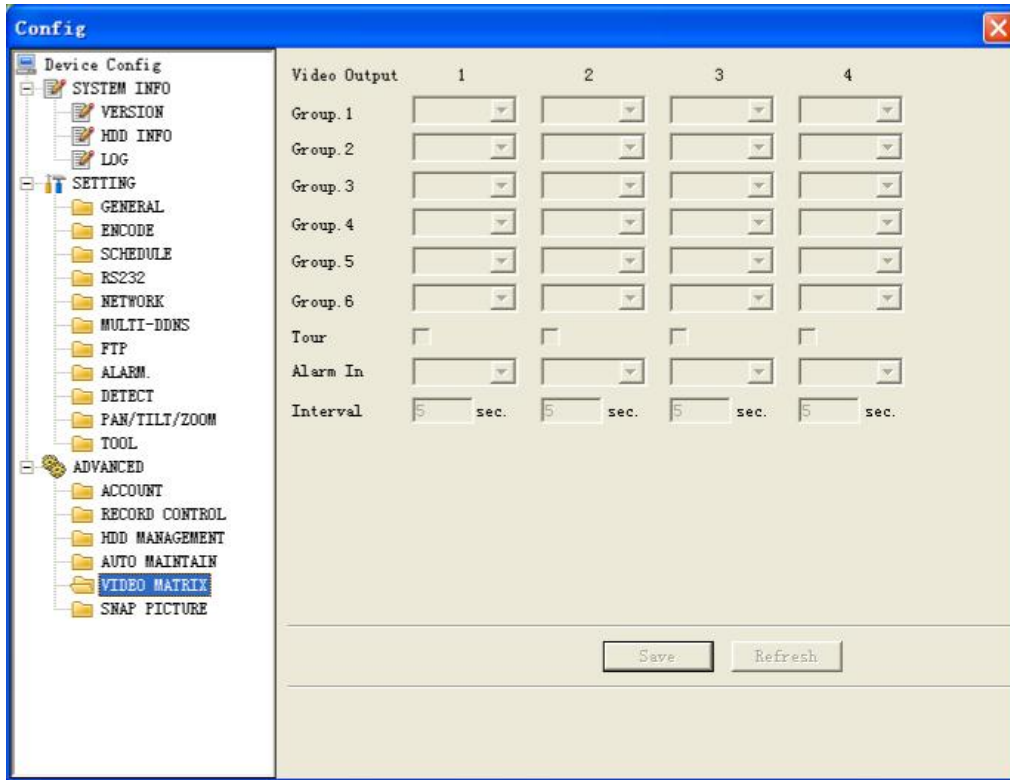

Figure 7-53

- **Snap Picture**

Snapshot interface is shown as in Figure 7-54. Please note this function depends on DVR available features.

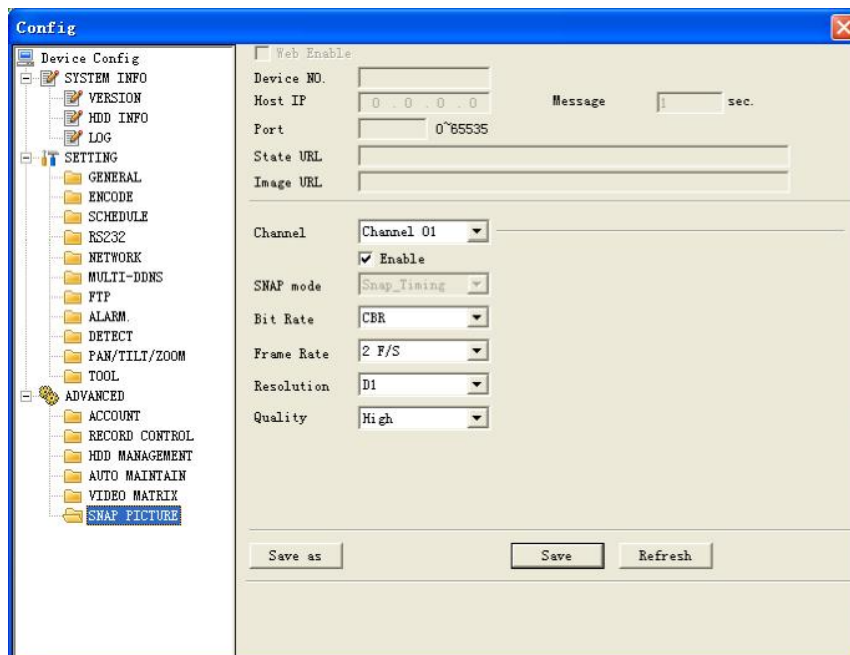

Figure 7-54

## 7.4 Search

Here you can select video type, channel number and time to search the file you want.

Click search button to display the interface below. See Figure 7-55

Please use page up/down key to view the search results. Double click file name to view the file and system will automatically backup the images in your installation directory.

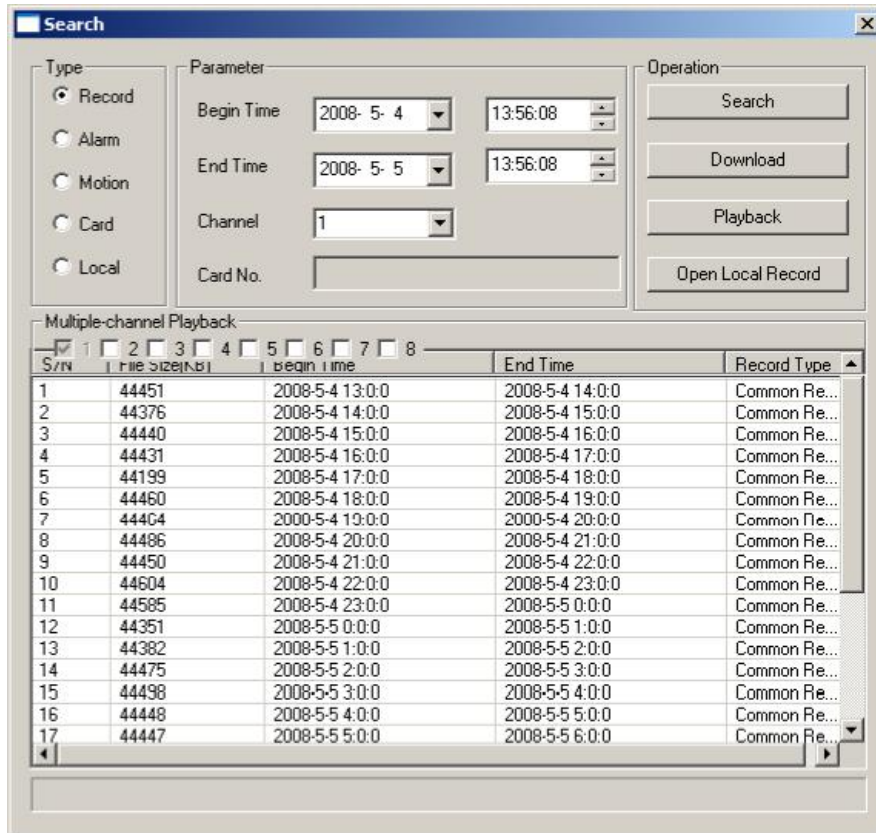

Figure 7-55

In the search result interface you can select one or more files to download to your local PC. The playback bar is shown below. See Figure 7-56.

- 1: Play
- 2: Pause
- 3: Stop
- 4: Slow play
- 5: Fast play

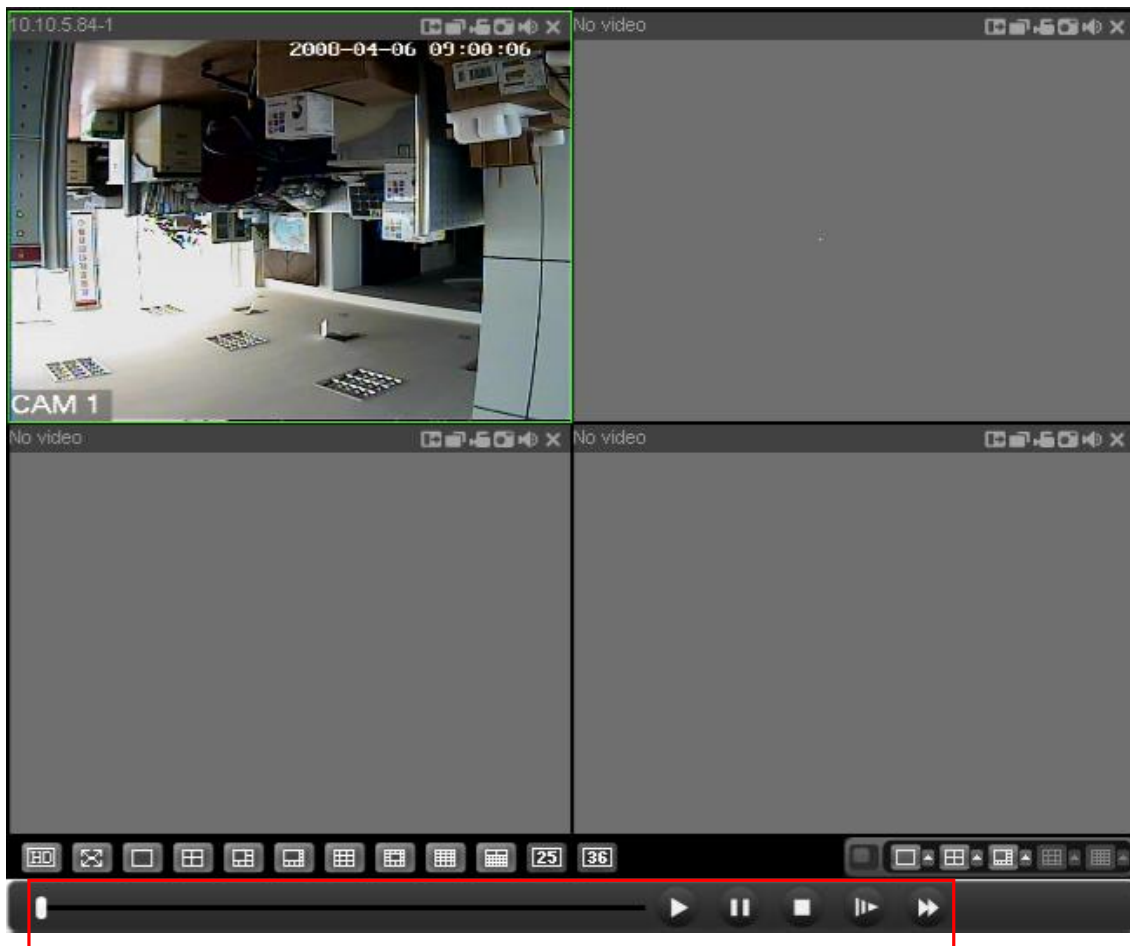

Figure 7-56

#### 7.4.1 Download

You can select one or more files you want to download and then click download button. System displays a dialogue box asking you specify directory. See Figure 7-57.

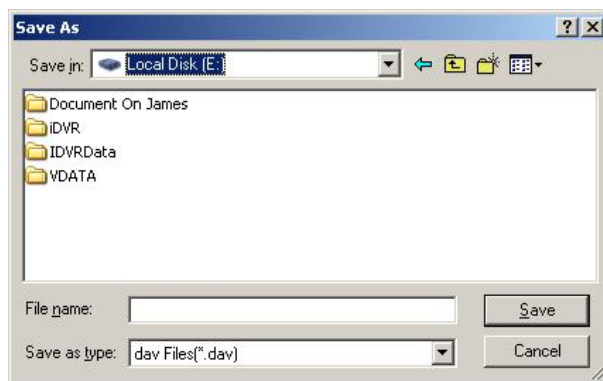

Figure 7-57

You can then input file name and click save to backup file in your local pc. During the download process, there is a process bar for you reference and you can see download button becomes stop button. See Figure 7-58.







Figure 7-60

## 7.7 Log out

Click log out button and system goes back to log in interface. See Figure 7-61.

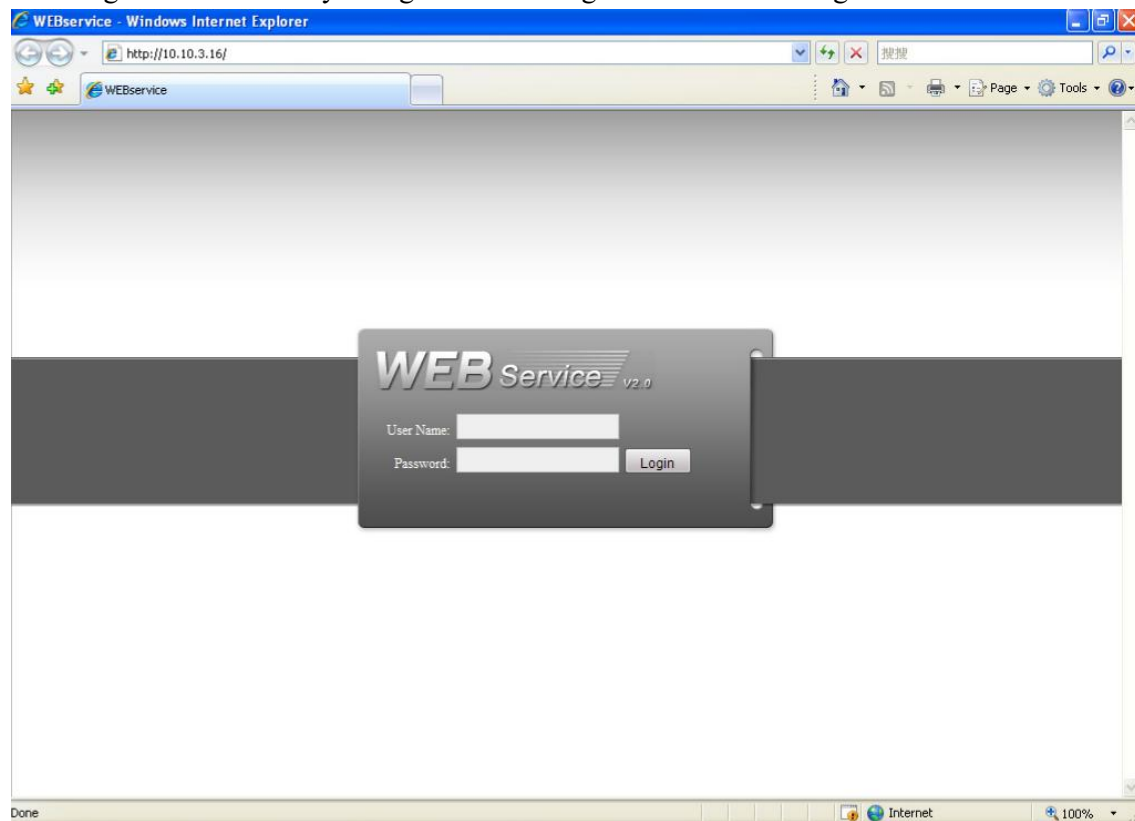

Figure 7-61

## 7.8 Un-install Web Control

You can use web un-install tool “uninstall web.bat” to un-install web control.

**Please note, before you un-install, please close all web pages, otherwise the un-install might result in error.**

## 8 SightBoss System

The sightBoss system allows you to manage a lot of DVRs remotely.

### 8.1 Features

The sightBoss system has the following features:

- Manages devices conveniently
- Supports multiple-device connection, real-time surveillance and playback
- Device management, log review and user management
- PTZ control and device alarm, video record
- Supports multiple-device upgrade simultaneously
- E-map and network backup support

### 8.2 Environment

We recommend the following minimum PC system configuration:

#### Hardware

- CPU P4 2.0G
- Video card: supports hardware zoom such as ATI, TNT2 PRO. We recommend ATI9800 or above dual channel. 128M/128bit
- Network card: 100M

#### Software

- For client end we recommend Windows 2000 or Windows XP.

### 8.3 Overview

Multiple-client main window is shown in Figure 8-1.

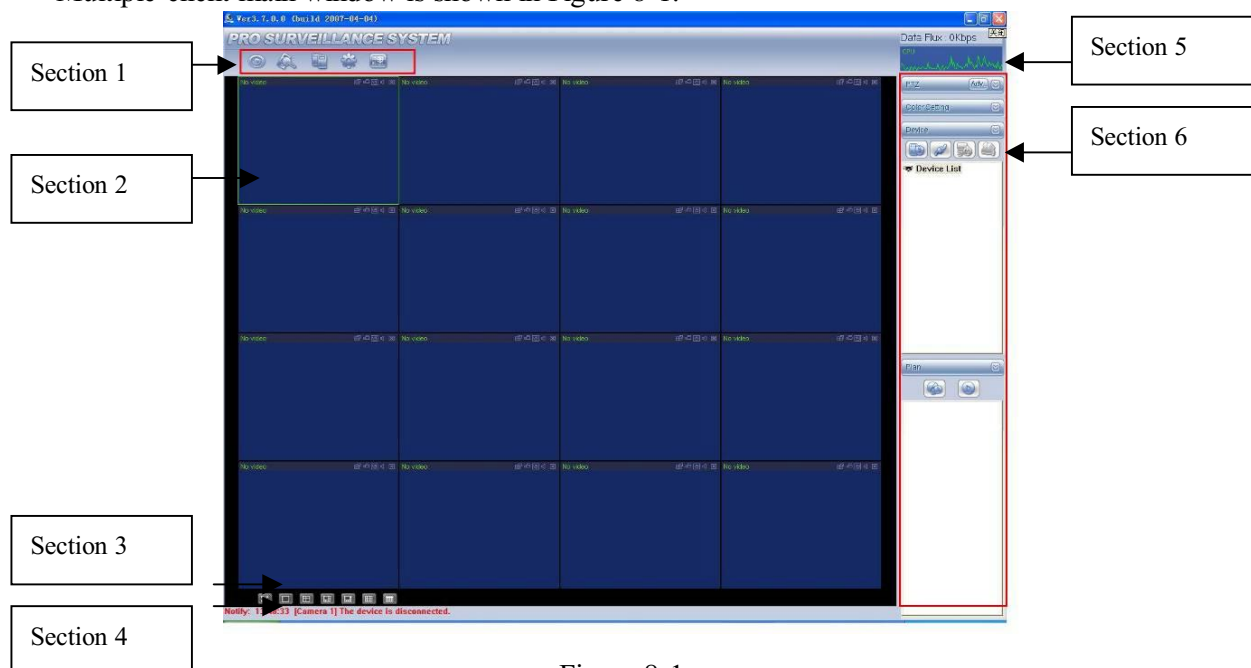

Figure 8-1

There are a total of six sections:

- Section 1: There are five function keys: monitor, record, device, system and e-map. Please refer to chapter four for detailed information.
- Section 2: View channel video.
- Section 3: Select display mode. System supports the following display modes: full-screen /single window/four-window/six-window/eight-window/nine-window/sixteen-window.
- Section 4: View current help information.
- Section 5: Display data flux and CPU status.
- Section 6: There are four function buttons: PTZ/Colour setting/Device/Plan. Please refer to chapter three for detailed information.

## **8.4 More Details**

Please refer to the SightBoss System User's Manual for more information.

## 9 Frequently Asked Questions

### 1. DVR will not boot up properly.

This can be due to the following:

Incorrect power supplied, poor connection or power switch damaged.

Incorrect BIOS loaded.

Hard drive malfunction or damaged data cable to hard drive.

Incompatible hard drive fitted.

Front panel error.

Damaged mainboard.

### 2. System cannot detect hard disk.

First check jumper position on drive and that IDE data cable and power cord are correctly connected. When only one hard drive is connected to an IDE interface, this hard drive has to be set as a Master.

### 3. I cannot use Schedule record function.

Please note the recording time unit takes one day as a working unit i.e.: from 0000hrs to 2400hrs.

### 4. Record light is flashing during the whole recording procedure.

Check the external video input signal. This problem usually happens when the inputting signal is not standard. Sometimes the reading speed of the Hard Drive is too slow. In this situation, you will need to change the hard drive.

### 5. My DVR is very hot, is there any problem?

The DVR365 does generate considerable heat. It is very important that the environment where the unit is installed is dry and free from dust. Always ensure the unit is installed in a well-ventilated position and that air vents are not covered.

### 6. I cannot see video signal on one channel while the other channels are ok

Check the video cable connection. Connect the camera video cable direct to the monitor to test. If there is still no signal, there may be a problem with the camera or video cable.

### 7. I cannot use my remote controller.

Check ACT light on the front panel is on or not.

- ATC light is on:

You need to change you remote controller battery.

- Act light is off:

Please move remote controller directly to the DVR, and then press address button. System displays address input dialogue box. Please input you remote address (default value is 008). When ACT light is on, you can use it.

**8. I cannot control PTZ or dome**

Check RS485 connections are correctly connected.

Check system setup. Please refer to 5.3.7 pan-tilt setup.

Protocol and Baud Rate must agree with physical PTZ setup.

**9. I cannot login via web**

There are two conditions:

- Network connection failure

Check your DVR and PC connections are correct. Please check DVR IP address, network cable and Gateway address. Use ping facility to check PC can see DVR.

- Invalid password or username. Please check correct username and password have been specified.

**10. When I first connect to the server video quality is poor.**

If the image returns to normal in five seconds, effect is normal.

**11. What peripheral equipment DVR can work with?**

This DVR supports equipment such as keyboards, alarm input and output equipment and alarm servers and access control systems.



## 10 Recording Times

### 10.1 Days Recording Per HDD Size Based on 4 Channel Machine

Resolution	Quality Setting	FPS	Gb/H Per Channel	Gb/H Per Machine	80Gb	160Gb	250Gb	300Gb	400Gb	750Gb	1000Gb
D1	6	25	1.22	4.88	0.7	1.4	2.1	2.6	3.4	6.4	8.5
D1	4	25	0.79	3.16	1.1	2.1	3.3	4.0	5.3	9.9	13.2
D1	1	25	0.36	1.44	2.3	4.6	7.2	8.7	11.6	21.7	28.9
D1	6	12	0.67	2.68	1.2	2.5	3.9	3.2	5.2	6.0	6.9
D1	4	12	0.43	1.72	1.9	3.9	6.1	7.3	9.7	18.2	24.2
D1	1	12	0.35	1.4	2.4	4.8	7.4	8.9	11.9	22.3	29.8
HD1	6	25	0.66	2.64	1.3	2.5	3.9	8.9	11.9	22.3	29.8
HD1	4	25	0.43	1.72	1.9	3.9	6.1	7.3	9.7	18.2	24.2
HD1	1	25	0.15	0.6	5.6	11.1	17.4	20.8	27.8	52.1	69.4
HD1	6	12	0.36	1.44	2.3	4.6	7.2	8.7	11.6	21.7	28.9
HD1	4	12	0.23	0.92	3.6	7.2	11.3	13.6	18.1	34.0	45.3
HD1	1	12	0.11	0.44	7.6	15.2	23.7	28.4	37.9	71.0	94.7
CIF	6	25	0.35	1.4	2.4	4.8	7.4	8.9	11.9	22.3	29.8
CIF	4	25	0.22	0.88	3.8	7.6	11.8	14.2	18.9	35.5	47.3
CIF	1	25	0.11	0.44	7.6	15.2	23.7	28.4	37.9	71.0	94.7
CIF	6	12	0.19	0.76	4.4	8.8	13.7	16.4	21.9	41.1	54.8
CIF	4	12	0.12	0.48	6.9	13.9	21.7	26.0	34.7	65.1	86.8
CIF	1	12	0.08	0.32	10.4	20.8	32.6	39.1	52.1	97.7	130.2



## 10.2 Days Recording Per HDD Size Based on 8 Channel Machine

Resolution	Quality Setting	FPS	Gb/H Per Channel	Gb/H Per Machine	80Gb	160Gb	250Gb	300Gb	400Gb	750Gb	1000Gb
D1	6	25	1.22	9.76	0.3	0.7	1.1	1.3	1.7	3.2	4.3
D1	4	25	0.79	6.32	0.5	1.1	1.6	2.0	2.6	4.9	6.6
D1	1	25	0.36	2.88	1.2	2.3	3.6	4.3	5.8	10.9	14.5
D1	6	12	0.67	5.36	0.6	1.2	1.9	6.4	2.6	12.1	3.5
D1	4	12	0.43	3.44	1.0	1.9	3.0	3.6	4.8	9.1	12.1
D1	1	12	0.35	2.8	1.2	2.4	3.7	4.5	6.0	11.2	14.9
HD1	6	25	0.66	5.28	0.6	1.3	2.0	4.5	6.0	11.2	14.9
HD1	4	25	0.43	3.44	1.0	1.9	3.0	3.6	4.8	9.1	12.1
HD1	1	25	0.15	1.2	2.8	5.6	8.7	10.4	13.9	26.0	34.7
HD1	6	12	0.36	2.88	1.2	2.3	3.6	4.3	5.8	10.9	14.5
HD1	4	12	0.23	1.84	1.8	3.6	5.7	6.8	9.1	17.0	22.6
HD1	1	12	0.11	0.88	3.8	7.6	11.8	14.2	18.9	35.5	47.3
CIF	6	25	0.35	2.8	1.2	2.4	3.7	4.5	6.0	11.2	14.9
CIF	4	25	0.22	1.76	1.9	3.8	5.9	7.1	9.5	17.8	23.7
CIF	1	25	0.11	0.88	3.8	7.6	11.8	14.2	18.9	35.5	47.3
CIF	6	12	0.19	1.52	2.2	4.4	6.9	8.2	11.0	20.6	27.4
CIF	4	12	0.12	0.96	3.5	6.9	10.9	13.0	17.4	32.6	43.4
CIF	1	12	0.08	0.64	5.2	10.4	16.3	19.5	26.0	48.8	65.1

### 10.3 Days Recording Per HDD Size Based on 16 Channel Machine

Resolution	Quality Setting	FPS	Gb/H Per Channel	Gb/H Per Machine	80Gb	160Gb	250Gb	300Gb	400Gb	750Gb	1000Gb
D1	6	25	1.22	19.52	0.2	0.3	0.5	0.6	0.9	1.6	2.1
D1	4	25	0.79	12.64	0.3	0.5	0.8	1.0	1.3	2.5	3.3
D1	1	25	0.36	5.76	0.6	1.2	1.8	2.2	2.9	5.4	7.2
D1	6	12	0.67	10.72	0.3	0.6	1.0	12.9	1.3	24.1	1.7
D1	4	12	0.43	6.88	0.5	1.0	1.5	1.8	2.4	4.5	6.1
D1	1	12	0.35	5.6	0.6	1.2	1.9	2.2	3.0	5.6	7.4
HD1	6	25	0.66	10.56	0.3	0.6	1.0	2.2	3.0	5.6	7.4
HD1	4	25	0.43	6.88	0.5	1.0	1.5	1.8	2.4	4.5	6.1
HD1	1	25	0.15	2.4	1.4	2.8	4.3	5.2	6.9	13.0	17.4
HD1	6	12	0.36	5.76	0.6	1.2	1.8	2.2	2.9	5.4	7.2
HD1	4	12	0.23	3.68	0.9	1.8	2.8	3.4	4.5	8.5	11.3
HD1	1	12	0.11	1.76	1.9	3.8	5.9	7.1	9.5	17.8	23.7
CIF	6	25	0.35	5.6	0.6	1.2	1.9	2.2	3.0	5.6	7.4
CIF	4	25	0.22	3.52	0.9	1.9	3.0	3.6	4.7	8.9	11.8
CIF	1	25	0.11	1.76	1.9	3.8	5.9	7.1	9.5	17.8	23.7
CIF	6	12	0.19	3.04	1.1	2.2	3.4	4.1	5.5	10.3	13.7
CIF	4	12	0.12	1.92	1.7	3.5	5.4	6.5	8.7	16.3	21.7
CIF	1	12	0.08	1.28	2.6	5.2	8.1	9.8	13.0	24.4	32.6

## 11 Networking a Digital Video Recorder

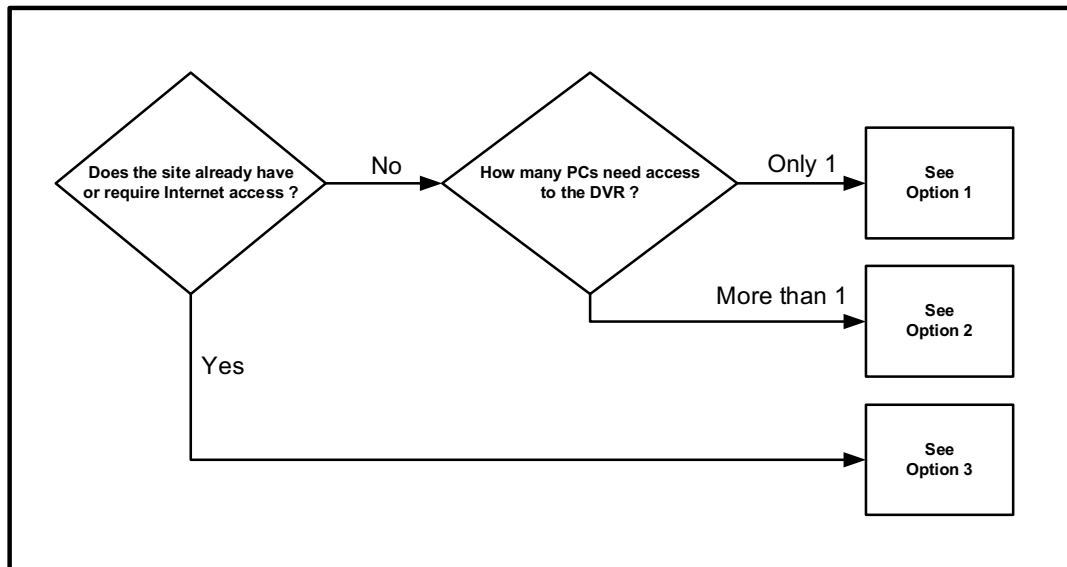

### 11.1 Basic Network Troubleshooting

You must be able to perform some basic tasks in order to connect your Digital Video Recorder to a PC and subsequently the Internet.

The following page describes some simple tasks but more help is available online at [www.systemq.com](http://www.systemq.com) so before you start please download the following tips from the website 'Online Support' section -

- Tip 117 Describing how to set a PC's IP Address
- TIP 36 Describing how to perform 'ping' test
- Tip 58 Describing how to configure a router for Internet access

The diagrams that follow suggest settings that if used will result in a successful connection.

Bear in mind that when it comes to Option 3 for Internet use, different router manufacturers may not use the exact settings given here so slight adjustments may be necessary.

### 11.1.1 How do I set my PC to 'Obtain an IP address automatically' ?

- Control Panel,
- Network Connections,
- Local Area Connection,
- Properties,
- Internet Protocol (TCP/IP),
- Properties,
- Select 'Obtain IP Address Automatically'

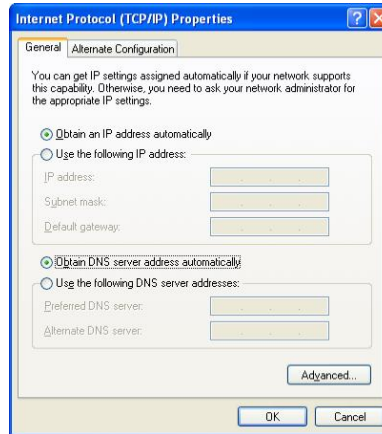

### 11.1.2 How do I set my PC's IP Address Manually ?

- Control Panel,
- Network Connections,
- Local Area Connection,
- Properties,
- Internet Protocol (TCP/IP),
- Properties,
- Select 'Use following IP Address'
- Enter ... IP Address  
Subnet mask  
Default gateway

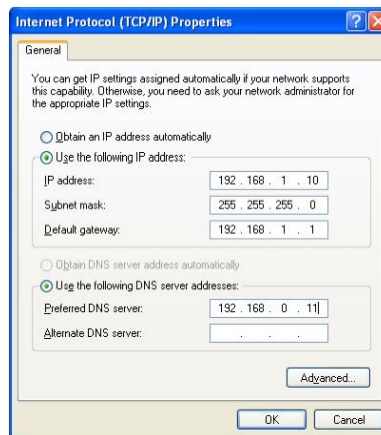

### 11.1.3 How do I find out my PC's IP Address ?

- Start
- Run
- Cmd
- ipconfig

### 11.1.4 How do I use Ping to test a Connection to my DVR ?

- Start
- Run
- Cmd
- Ping <IP-Address> <Enter> eg: ping 192.168.1.108 <Enter>

### **11.1.5 How do I Configure a Router for Remote Access ?**

- Instructions on the System Q website cover the NET800 and Netgear Routers

### **11.1.6 How do I find the On-Line Support ?**

<http://www.systemq.com/cgi-bin/commerce.exe?display=user2>

Detailed descriptions are available there for all these questions plus more besides, including ...

- How to find a device's MAC address (Tip 3)
- How to implement Dynamic DNS (Tip 56)
- Setting Internet Explorer Security Settings to install an Active-X (Tip 94)
- How to control a PTZ from a DVR
- How to play back recordings from various DVRs
- Links for downloading client software packages

### 11.2.1 Option 1 : Connect a DVR Directly to a Single PC

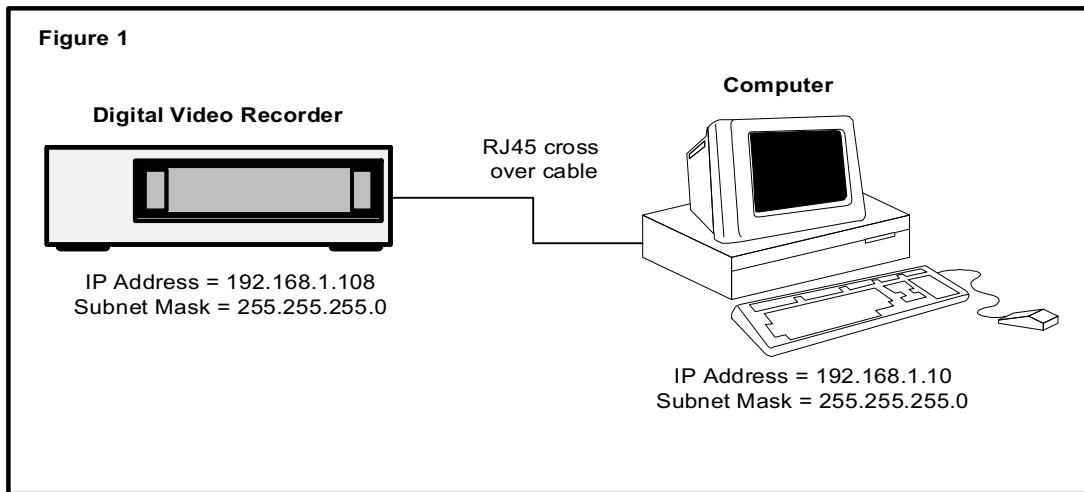

#### Tasks :

- Configure network settings in DVR manually
- Configure network settings in PC manually
- Connect DVR & PC together using an RJ45 cross over cable
- Install and configure the DVR client software
- Reboot both DVR & PC
- Test the PC's connection to the DVR using 'Ping'
- Connect using the client software

## 11.2.2 Option 2 : Connect a DVR to a PC via a Switch or Hub

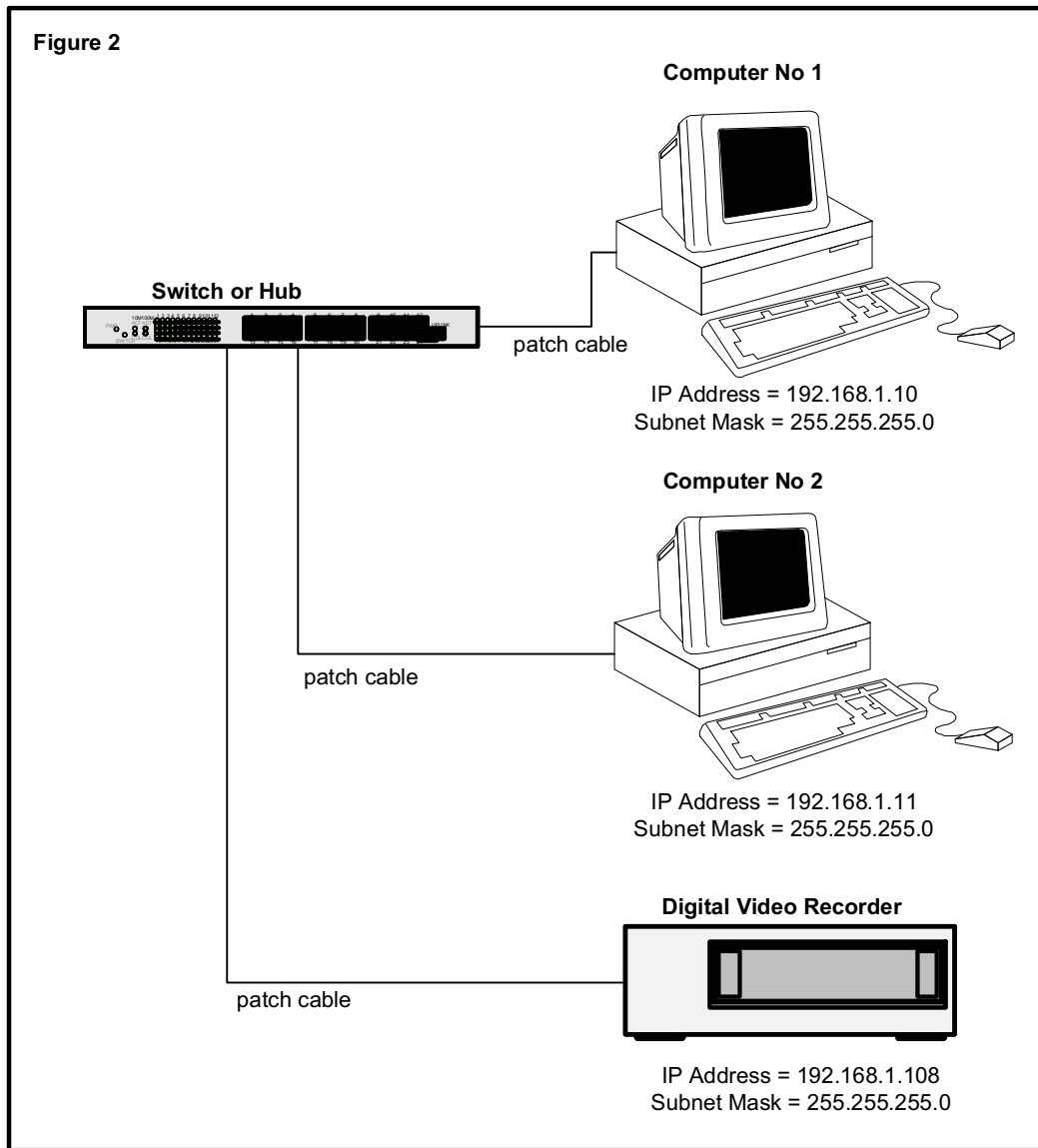

### Tasks :

- Configure network settings in DVR manually
- Configure network settings in PC manually
- Connect DVR & PC together using an RJ45 cross over cable
- Install and configure the DVR client software
- Reboot both DVR & PC
- Test the PCs connection to the DVR using 'Ping'
- Connect using the client software

### 11.2.3 Option 3 : Connecting for Internet Access

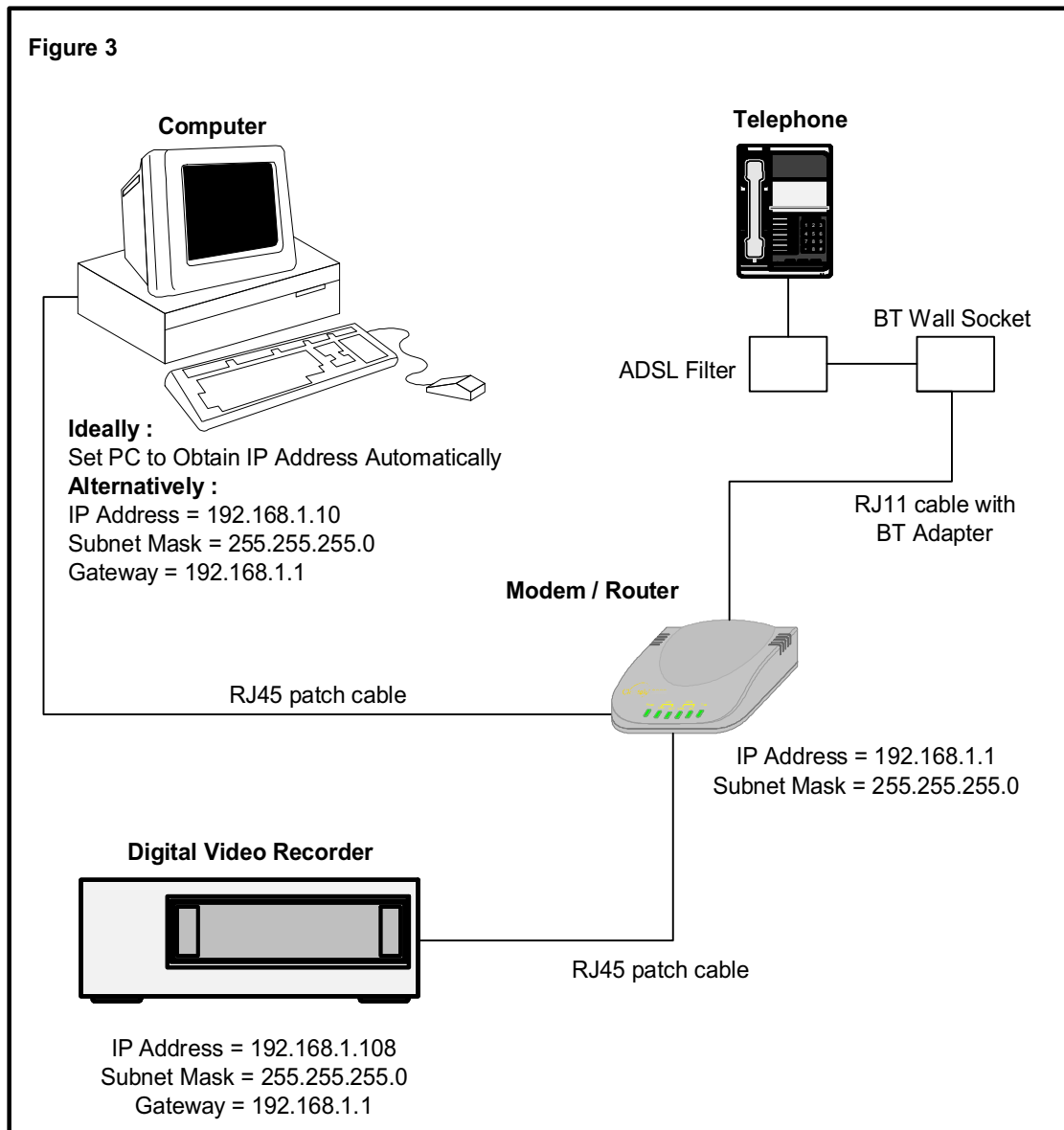

#### **Important Notes :**

If using a BT phone line you must use an ADSL modem router, if using a NTL or cable phone service you must use an appropriate cable router.

Be aware that when connected to the internet, the router has two IP addresses: internal and external. The internal address is seen by devices connecting to its Ethernet ports, the external address represents its connection to the local exchange via the telephone line.



**Tasks :**

- Find out what the external IP address is, this is assigned by the customer's Internet Service Provider
- Find out : is this a fixed IP address, ie: "Static, or does it change, ie: "Dynamic" ?
- Configure network settings in the DVR manually
- Configure network settings in the PC to "Obtain IP Address Automatically" if possible, if not, then configure manually
- Connect DVR & PC to the modem/router using patch cables
- Install and configure the DVR client software
- Reboot both DVR & PC
- Test the PCs connection to the DVR using 'Ping'
- Use the client software to connect to the DVR from the local PC
- Ensure the PC has outbound Internet access
- Configure the modem router for inbound access using either "Port Forwarding", or "DMZ"
- Ask a colleague offsite to test Internet access by connecting to the router's external IP address

## Appendix A HDD Capacity Calculation

Calculate total capacity needed by each DVR according to video recording (video recording type and video file storage time).

Step 1: According to Formula (1) to calculate storage capacity  $q_i$  that is the capacity of each channel needed for each hour, unit Mbyte.

$$q_i = d_i \div 8 \times 3600 \div 1024 \quad (1)$$

In the formula:  $d_i$  means the bit rate, unit Kbit/s

Step 2: After video time requirement is confirmed, according to Formula (2) to calculate the storage capacity  $m_i$ , which is storage of each channel needed unit Mbyte.

$$m_i = q_i \times h_i \times D_i \quad (2)$$

In the formula:

$h_i$  means the recording time for each day (hour)

$D_i$  means number of days for which the video shall be kept

Step 3: According to Formula (3) to calculate total capacity (accumulation)  $q_T$  that is needed for all channels in the DVR during **scheduled video recording**.

$$q_T = \sum_{i=1}^c m_i \quad (3)$$

In the formula:  $c$  means total number of channels in one DVR

Step 4: According to Formula (4) to calculate total capacity (accumulation)  $q_T$  that is needed for all channels in DVR during **alarm video recording (including motion detection)**.

$$q_T = \sum_{i=1}^c m_i \times a\% \quad (4)$$

In the formula  $a\%$  means alarm occurrence rate