



ZIP AI IP Camera

IPCAI020

© 2021 System Q Ltd

ZipNVR.com

Table of Contents

Part 1 Introduction	1
1 Key Features	1
2 Essential Tools and ZipFinder	1
Part 2 Connections and Dimensions	3
1 IPCAI020 Module 3.7mm Pinhole	3
Part 3 Setup Options	4
1 PoE ZIP NVR	4
2 Non-PoE ZIP NVR	5
Part 4 Setup and AI Features	6
1 PID = Perimeter Intrusion Detection	8
2 LCD = Line Crossing Detection	10
3 PD & VD = Pedestrian Detection and Vehicle Detection	12
4 FD = Facial Detection	15
Part 5 Browser Menu Settings	19
Part 6 Extra Resources	26
1 ZipNVR.com Website	26
2 Adding IP Cameras	26
3 ZIP Firmware	26
Part 7 General Maintenance	27
Part 8 Specification	28
1 IPCAI020	28
Part 9 Conditions	29
Index	30

1 Introduction

The ZIP AI Cameras provide triggering with smart detection features such as *line crossing*, *pedestrian detection*, *facial detection*.

Only one smart detection feature can be enabled at any given time.

Facial recognition can be set when connected to a compatible ZIP NVR with iSENSE firmware.

In order to use the ZIP AI cameras with a ZIP NVRs the latest iSENSE firmware is required, please see [Extra Resources](#)²⁶.

1.1 Key Features

- Alarm input and output*
- Audio input and output*
- Supports H264 and H265
- Supports ONVIF (Profile S, Profile G, Profile T)
- SD card*
- Perimeter intrusion
- Line crossing
- Pedestrian and vehicle detection
- Facial detection
- IP66 (*Excluding the IPCAI020*)

**On selected models*

1.2 Essential Tools and ZipFinder

To install this product you will need:

- Laptop / Windows PC
- Screwdriver
- Drill
- Hammer
- ZIP NVR or DVR
- PoE Switch / 12V DC power supply
- Ethernet CAT5/5e/6 Cable

ZipFinder - IP Camera Configuration Tool

ZipFinder is a Windows PC software for discovering and configuring IP cameras a network.

Use ZipFinder on non-PoE installs, to help problem solving issues such as forgotten or unknown IP Addresses.

To download visit ZipNVR.com

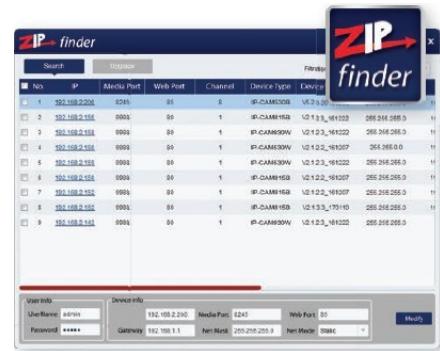

2 Connections and Dimensions

2.1 IPCA1020 Module 3.7mm Pinhole

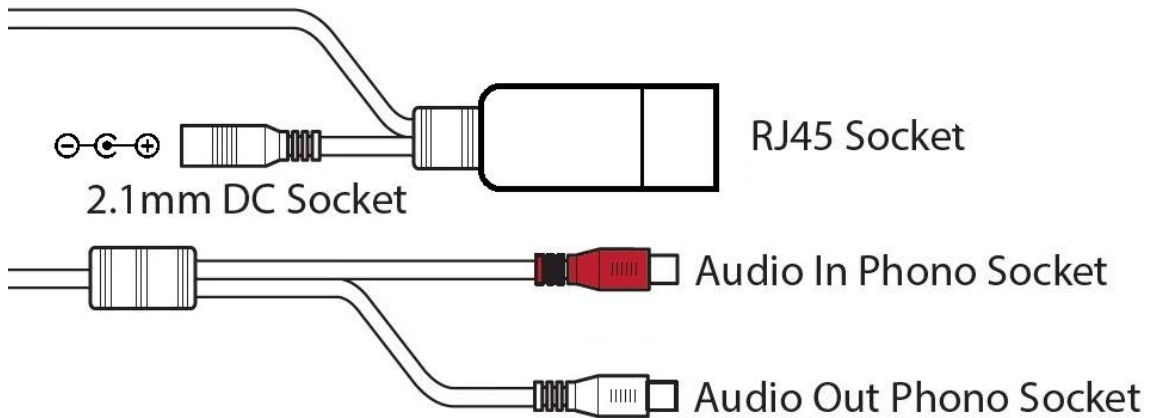

Powering the camera

Option 1 - Power the camera from 12V DC (via the 2.1mm DC Socket), the current consumption is 150mA. The camera is polarity sensitive so connections must be correctly made.

Option 2 - Power the camera using a PoE 48V RJ45 Socket

When connecting to a **ZIP PoE NVR** plug the camera directly into the NVRs built in PoE switch.



*Dimensions Exclude Bracket

3 Setup Options

3.1 PoE ZIP NVR

When connecting to a **ZIP PoE NVR** plug the camera directly into the NVR's built in PoE switch.

The camera should automatically become visible after being connected for approximately 1 minute.

The 100m distance for a camera can be increased when the PoE Mode is set to EPoE.

In the menu on a ZIP PoE NVR go to:-

Video > IP Channels > PoE Mode

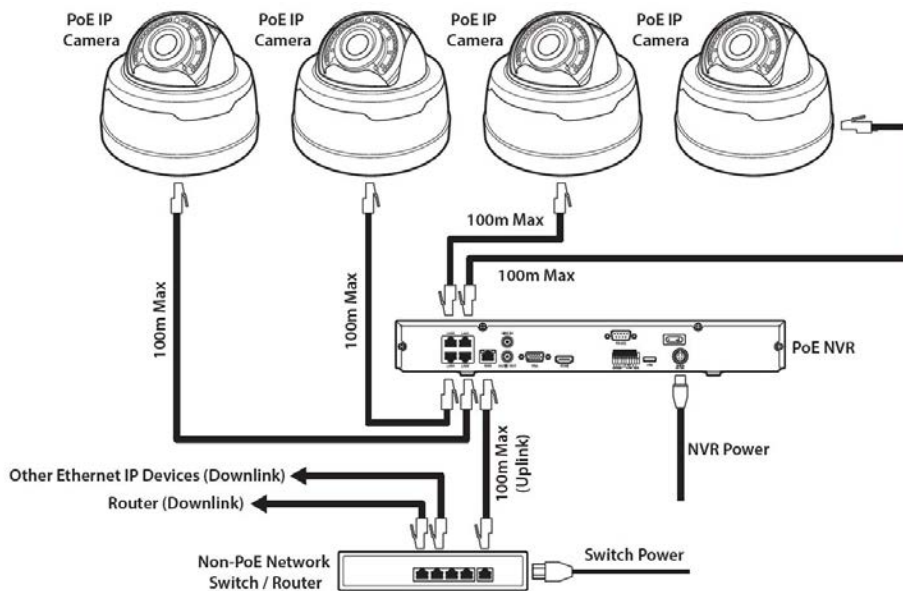

3.2 Non-PoE ZIP NVR

When connecting cameras to a **Non-PoE NVR**, they are first connected to an external network switch which is in-turn connected to the NVR as shown below.

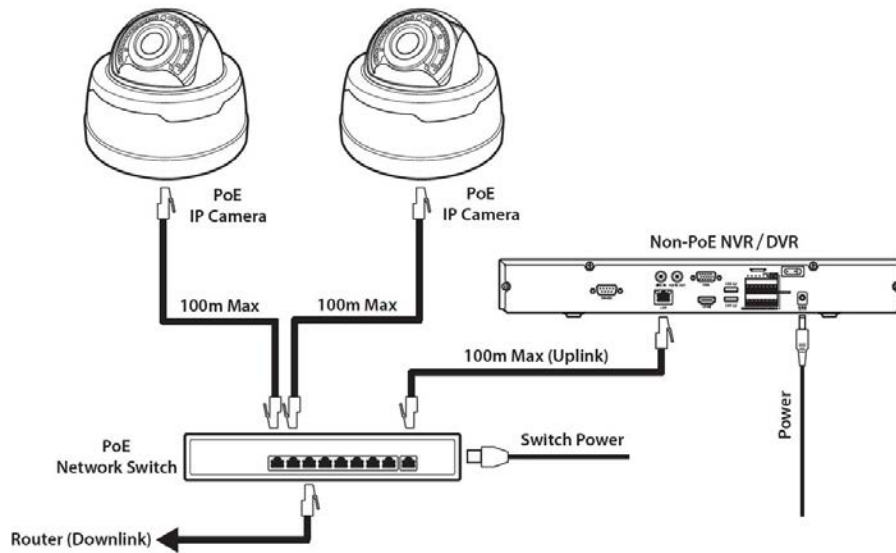

See [Extra Resources](#)²⁶ for more information on **Adding IP Cameras manually** to a ZIP Recorder.

4 Setup and AI Features

The AI smart features can be configured in a ZIP recorder or directly in the browser interface of the camera (standalone)

Only one smart detection feature can be enabled at any given time.

See the NVR or DVR manual for information on configuring these features with a ZIP recorder.

Follow the steps below for configuring the settings directly in the camera via a browser for standalone setup.

You will need...

- Windows Based PC/ Laptop connected to router/ PoE switch
- ZipVision Pro App on Mobile Device
- PoE Switch connected to Network/ Router
- Ethernet network cable
- [ZipFinder](#) software, available via this link below:-

www.softcctv.com/store/Item/Zip-Finder-IP-CCTV-Security-Camera-Discovery-Tool

1. Plug the camera's RJ45 port with a network cable into a PoE switch

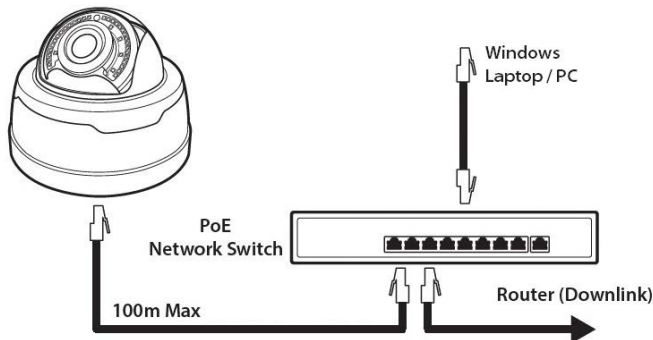

2. Using ZipFinder on a Windows Based PC/ Laptop **Search** and then tick the camera



3. Select Net Mode = **DCHP**, then click **Modify**

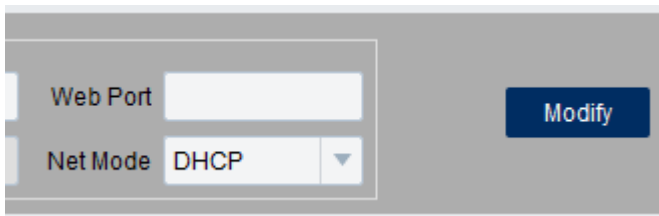

4. **Search** again, to get the updated IP address.

5. **Select** the IP address of the camera, Internet Explorer will pop-up, and ask to download and install the plug-in.

6. **Download, install** and follow the steps for the plug-in installation, then re-load the browser by **selecting** the IP address again.

5. Login to the IP Camera, the **default** login details are:-

User Name	admin
Password	777777

6. Go to **Remote Setting > Smart > Detection**

4.1 PID = Perimeter Intrusion Detection

Perimeter intrusion detection can be set to trigger an alarm event when movement is detected in a set area.

Smart ▸ Detection

PID
LCD
PD&VD
FD

Name	Perimeter Intrusion Detection (PID)
Switch	<input checked="" type="checkbox"/>
Latch Time	5S
Post Recording	5S
Sensitive	2
Scene	Indoor
Alarm Out	<input checked="" type="checkbox"/>
Send Email	<input type="checkbox"/>
Detection Type	<input type="checkbox"/> Pedestrian <input type="checkbox"/> Vehicle
Rule Number	1
Rule Switch	<input type="checkbox"/>
Rule Type	A → B
Enable Record	<input type="checkbox"/>

Refresh Save



Clear
Clean All

Key Settings

Switch - Tick to enable this feature.

Un-Tick to disable this feature.

Latch Time - This determines how long the alarm event is deemed to be activate once triggered. Options are 5, 10, 20 and 30 seconds.

Post Recording - This determines how long the camera will record for after the alarm event has ended. Options are 5, 10, 20 and 30 seconds.

Sensitivity - Determines how much activity or movement is required to generate an event. Options are **1 - 4**.

1 = Lowest sensitivity level, a significant amount of movement is needed to trigger

4 = Highest sensitivity level, only a small amount of moment is needed to trigger

Scene - Set for light level location to improve detection. Options are indoor or outdoor.

Send Email - Email alert via SMTP can be triggered and send a snapshot image of the event.
Note:- Email Settings required to be set up in Network Menu for this feature.

Rule Number - Up to 4 areas can be set independently in the image area. Use this to enable / disable each of the 4 rules.

Rule Switch - Tick to enable or disable the detection that rule for the rule number selected.

Rule Type - The determines how the direction of moment over the perimeter is handled.

A to B (A->B) = Only movement in the direction A to B will trigger.

B to A (B->A) = Only movement in the direction B to A will trigger.

A or B (A<->B) = Any moment direction over the perimeter will trigger.

Enable Record - Tick to enable recording when the event is triggered.

Un-Tick to disable recording when the event is triggered.

4.2 LCD = Line Crossing Detection

Line crossing detection can be set to trigger an alarm event when movement is detected across a custom line

Smart ▶ LCD

PID
LCD
PD&VD
FD

Name	Line Crossing Detection (LCD)
Switch	<input checked="" type="checkbox"/>
Latch Time	<input type="text" value="5S"/>
Post Recording	<input type="text" value="5S"/>
Sensitive	<input type="text" value="2"/>
Scene	<input type="text" value="Indoor"/>
Alarm Out	<input checked="" type="checkbox"/>
Send Email	<input type="checkbox"/>
Detection Type	<input type="checkbox"/> Pedestrian <input type="checkbox"/> Vehicle
Rule Number	<input type="text" value="1"/>
Rule Switch	<input type="checkbox"/>
Rule Type	<input type="text" value="A → B"/>
Enable Record	<input type="checkbox"/>

Refresh Save



Key Settings

Switch - Tick to enable this feature.

Un-Tick to disable this feature.

Latch Time - This determines how long the alarm event is deemed to be activate once triggered. Options are 5, 10, 20 and 30 seconds.

Post Recording - This determines how long the camera will record for after the alarm event has ended. Options are 5, 10, 20 and 30 seconds.

Sensitivity - Determines how much activity or movement is required to generate an event. Options are **1 - 4**

1 = Lowest sensitivity level, a significant amount of movement is needed to trigger

4 = Highest sensitivity level, only a small amount of moment is needed to trigger

Scene - Set for light level location to improve detection. Options are indoor or outdoor.

Send Email - Email alert via SMTP can be triggered and send a snapshot image of the event.
Note:- Email Settings required to be set up in Network Menu for this feature.

Detection Type - Tick to enable, options are pedestrian, vehicle. (Both can be enabled simultaneously)

Rule Number - Up to 4 areas can be set independently in the image area. Select the number to control the setting of that specific area.

Rule Switch - Tick to enable or disable the detection that rule for the rule number selected.

Rule Type - The determines how the direction of moment over the perimeter is handled.

A to B (A->B) = Only movement in the direction A to B will trigger.

B to A (B->A) = Only movement in the direction B to A will trigger.

A or B (A<->B) = Any moment direction over the perimeter will trigger.

Enable Record - Tick to enable recording when the event is triggered.

Un-Tick to disable recording when the event is triggered.

4.3 PD & VD = Pedestrian Detection and Vehicle Detection

Pedestrian detection and vehicle detection can be set to trigger an alarm event in a custom area when it detects pedestrians, vehicles or both.

Smart ▶ PD

PID
LCD
PD&VD
FD

Name	Pedestrian Detection(PD&VD)		
Switch	<input checked="" type="checkbox"/>		
Latch Time	<input type="text" value="5S"/>		
Post Recording	<input type="text" value="5S"/>		
Sensitivity	<input type="text" value="60"/>		
Alarm Out	<input type="checkbox"/>		
Send Email	<input type="checkbox"/>		
Snap Mode	<input type="text" value="Interval Mode"/>		
Snap Num	<input type="text" value="1"/>		
Snap Frequency	<input type="text" value="2"/>	s/pic	
Min Pixel	<input type="text" value="64"/>	(64-1080)	
Detection Type	<input checked="" type="checkbox"/> Pedestrian <input checked="" type="checkbox"/> Vehicle		
Detection Mode	<input type="text" value="Motion Mode"/>		
Detection Range	<input type="text" value="Full Screen"/>		
Enable Record	<input type="checkbox"/>		



Key Settings

Switch - Tick to enable this feature.

Un-Tick to disable this feature.

Latch Time - This determines how long the alarm event is deemed to be activate once triggered. Options are 5, 10, 20 and 30 seconds.

Post Recording - This determines how long the camera will record for after the alarm event has ended. Options are 5, 10, 20 and 30 seconds.

Sensitivity - Determines how much activity or movement is required to generate an event. Options are **1 - 4**

1 = Lowest sensitivity level, a significant amount of movement is needed to trigger

4 = Highest sensitivity level, only a small amount of moment is needed to trigger

Send Email - Email alert via SMTP can be triggered and send a snapshot image of the event.
Note:- Email Settings required to be set up in Network Menu for this feature.

Snap Mode - Set how the camera will capture thumbnail snapshots when triggered.

Default = Will only capture a snapshot when subjects are first detected. Additional thumbnail snapshots will only be captured if the subject leaves the camera's image and returns

Realtime: Only capture a snapshot from just before the subject leaves the image.

Interval Mode = Customize how many and how often thumbnail snapshots are captured using the **snap num** and **snap frequency** fields.

Snap Num - Set how many snapshots are captured for each event

1 = Will capture a single snapshot when the subject is first detected.

2 = Will capture a snapshot when the subject is first detected and one further snapshot at the interval as set by the snap frequency, if the subject is still present.

3 = Will capture a snapshot when the subject is first detected and two further snapshots, one further snapshot at the interval as set by the snap frequency, if the subject is still present.

Unlimited = Will continuously capture a snapshot at the interval as set by the snap frequency, if the subject is still present.

Snap Frequency - Customise how often the camera will capture a snapshot (in seconds), this is a timer which will remain active as long as the subject is present. If the subject leaves the camera's image and returns a snapshot will be captured and the timer will reset.

Min Pixel - Set the minimum trigger size, this can be set as a minimum width between 64 pixels to 1080 pixels. Customize the size depending on how far away the camera is away from the subject.

Detection Type - Tick to enable, options are pedestrian and vehicle. (Both can be enabled simultaneously)

Detection Mode - How the detection will handle motion and stationary objects.

Motion mode = Will only detect moving subjects.

Static mode = Will detect moving subjects but also stationary pedestrians and vehicles are in the alarm area.

Detection Range - Set the detection area for the image

Customize = Customise a defined detection area

Full Screen = Set to Monitor the entire image

Enable Record - Tick to enable recording when the event is triggered.

Un-Tick to disable recording when the event is triggered.

4.4 FD = Facial Detection

Facial detection can be set to trigger an alarm event in a custom area when it detects a face/

AI Face Recognition is available on these model NVRs:- ZIP108, ZIP116, ZIP208, ZIP308, ZIP216 and ZIP226.

Smart ▸ FD

PID
LCD
PD&VD
FD

Name	Face Detection(FD)	
Switch	<input checked="" type="checkbox"/>	
Latch Time	<input type="text" value="5S"/>	▼
Post Recording	<input type="text" value="5S"/>	▼
Alarm Out	<input type="checkbox"/>	
Send Email	<input type="checkbox"/>	
Face Enhance	<input checked="" type="checkbox"/>	
Snap Mode	<input type="text" value="Interval Mode"/>	▼
Apply Mode	<input type="text" value="Frontal View"/>	▼
Snap Num	<input type="text" value="1"/>	▼
Snap Frequency	<input type="text" value="2"/>	s/pic
Min Pixel	<input type="text" value="32"/>	(32-1080)
Detection Mode	<input type="text" value="Motion Mode"/>	▼
Rule Kind	<input type="text" value="Rect"/>	▼
Detection Range	<input type="text" value="Customize"/>	▼
Enable Record	<input type="checkbox"/>	



Key Settings

Switch - Tick to enable this feature.

Un-Tick to disable this feature.

Latch Time - This determines how long the alarm event is deemed to be activate once triggered. Options are 5, 10, 20 and 30 seconds.

Post Recording - This determines how long the camera will record for after the alarm event has ended. Options are 5, 10, 20 and 30 seconds.

Send Email - Email alert via SMTP can be triggered and send a snapshot image of the event. Note:- Email Settings required to be set up in Network Menu for this feature.

Snap Mode - Set how the camera will capture thumbnail snapshots when triggered.

Default = Will only capture a snapshot when subjects are first detected. Additional thumbnail snapshots will only be captured if the subject leaves the camera's image and returns

Realtime: Only capture a snapshot from just before the subject leaves the image.

Interval Mode = Customize how many and how often thumbnail snapshots are captured using the **snap num** and **snap frequency** fields.

Snap Num - Set how many snapshots are captured for each event

1 = Will capture a single snapshot when the subject is first detected.

2 = Will capture a snapshot when the subject is first detected and one further snapshot after the period of time specified in the snap frequency field if the subject is still present.

3 = Will capture a snapshot when the subject is first detected and two further snapshots, one further snapshot after the period of time specified in the snap frequency field if the subject is still present.

Unlimited = Will continuously capture a snapshot at the interval as set by the snap frequency, if the subject is still present.

Snap Frequency - Customise how often the camera will capture a snapshot (in seconds), this is a timer which will remain active as long as the subject is present. If the subject leaves the camera's image and returns a snapshot will be captured and the timer will reset.

Apply Mode - Customise the face detecting viewing angle for the most accurate face detection.

Frontal View - The camera optimizes the detection for straight on.

Multi Angle - The camera detects faces at various angles.

Customise - Customise to set up bespoke detection angles/

Roll Range - How far somebody can tilt their head (ear towards their shoulder) and still be detected as a face. Set the angle from 0 degrees so that a face would have to be straight to 180 degrees so that the face can be tilted 90 degrees to either side.

Pitch Range - How far a person can look up or down and still be detected. At 0 degrees the subject would have to be looking directly at the camera. At 180 degrees the subject can be looking towards the ground or towards the sky and could still be detected.

Yaw Range - How far somebody can be looking to the side and still be detected. At 0 degrees the subject would have to be looking directly at the camera. At 180 degrees the subject can be side on to the camera and could still be detected.

Min Pixel - Set the minimum trigger size, this can be set as a minimum width between 64 pixels to 1080 pixels. Customize the size depending on how far away the camera is away from the subject.

Detection Mode - How the detection will handle motion and stationary objects.

Motion mode = Will only detect moving subjects.

Static mode = Will detect moving subjects but also stationary pedestrians and vehicles are in the alarm area.

Rule Kind - Set to trigger an alarm event when a face is detected in a set area or set to trigger an alarm event when a face is detected across a custom line.

Rect - Face detection within a set area.

To create a custom detection area;

1. Set the **rule kind** drop down list to **rect**.
2. Set the **detection area** drop down list to **customise**.
3. Click on the camera's image to set the top left corner of the detection area.
4. Click the position to set the bottom left corner.
5. Click the position to set the bottom right corner.
6. Click to set the top right corner of the detection area.

Line - Face detection across a custom line. Customise the direction the line is crossed before a capture so the camera will monitor for face on entry or as people exit.

To set up line crossing face detection follow these steps:

1. Set the **rule kind** drop down list to **line**.
2. Click on the camera's image to start the line crossing.
3. Click to stop the line crossing.
4. Finally select which direction a person crosses the line before face detection is triggered from the **rule type** drop down list, from side **A** to **B** (**A->B**) or from side **B** to **A** (**B->A**).

Detection Range - Set the detection area for the image.

Customize = Customise a defined detection area

Full Screen = Set to Monitor the entire image

Enable Record - Tick to enable recording when the event is triggered.

Un-Tick to disable recording when the event is triggered.

5 Browser Menu Settings

The menu be configured directly in the browser interface of the camera (standalone), in Remote Setting you will find the menu settings.

Camera	OSD Menu	Name	Customise Name	
		Flicker Control	50Hz / 60Hz	
		Transparency	1 ~ 128 (Default 64)	
		Show Name	Untick / Tick	
		Show Time	Untick / Tick	
		Refresh / Save		
	Camera Settings	IR-CUT Mode	Auto / Colour Mode / Black White Mode / Schedule (B/W)	
		IR-CUT Delay	1 ~ 36 (Default 2)	
		IR-LED	Auto / Off / On	
		Flip	Untick / Tick	
		Mirror	Untick / Tick	
		Corridor Mode	Untick / Tick	
		Angle Rotation	180 / 0	
		Backlight	Untick / Tick	
		3D Noise Reduction	Auto / Disable / Manual	
		DWDR	Untick / Tick	
		HLC	Untick / Tick	
		AGC	1 ~ 128 (Default 64)	
		White Balance	Auto / Manual / Indoor	
		Shutter	Auto / Manual	
		Time Exposure (max)	1/5 / 1/8 / 1/15 / 1/25 / 1/50 / 1/100 / 1/150 / 1/180 / 1/200 / 1/240 / 1/250 / 1/300 / 1/360 / 1/480 / 1/500 / 1/600 / 1/700 / 1/1000 / 1/1500 / 1/2500 / 1/5000 / 1/10000 / 1/12000 / 1/20000 / Flickerless	
		Defog Mode	Disable / Auto / Manual	
		Refresh / Save / Default		
	Privacy Mask	Privacy Mark	Untick / Tick	
		Refresh / Save		
	ROI	Stream Type	MainStream / SubStream / MobileStream	
		Region ID	1 ~ 8	
		Enable Region	Disable / Enable	
		ROI Level	Worst / worse / bad / normal / better / best	
		Non-ROI Fps (1-19)	12	
		Refresh / Save		
	Network	Network	Type	DCHP / PPPoE / Static
			Client Port	8240
HTTP Port			80	

		IP Address	192.168.10.1	
		Subnet Mask	255.255.255.0	
		Gateway	192.168.10.254	
		DNS 1	192.168.10.254	
		DNS 2	Untick / Tick	
		UPNP	Untick / Tick	
		Multicast	Untick / Tick	
		P2P Switch	Untick / Tick	
		Port Range	1024 ~ 65535 (Client Port, HTTP Port)	
		Refresh / Save		
	Encoding	Mainstream	Resolution	1920x1080 / 1280x720 / 1280x960
			FPS	1 ~ 20 (Default 12)
			Video Code Type	H.264 / H.265
			Video Code Level	Main Profile / Baseline / High Profile
			Bitrate Control	CBR / VBR
			Bitrate Mode	Predefined / User Defined
			Bitrate	256 / 320 / 384 / 448 / 512 / 640 / 768 / 896 / 1024 / 1280 / 1536 / 1792 / 2048 / 3072 / 4096 / 5120 / 6144 / 8192
			Audio	Untick / Tick
			I Frame Interval	1 ~ 80 (Default 24)
			Refresh / Save	
		SubStream	Resolution	1280x720 / 640x480 / 320x240
			FPS	1 ~ 20 (Default 10)
			Video Code Type	H.264 / H.265
			Video Code Level	Main Profile / Baseline / High Profile
			Bitrate Control	CBR / VBR
			Bitrate Mode	Predefined / User Defined
			Bitrate	128 / 160 / 192 / 224 / 256 / 320 / 384 / 448 / 512 / 640 / 768 / 896 / 1024
			Audio	Untick / Tick
			I Frame Interval	1 ~ 80 (Default 20)
			Refresh / Save	
		MobileStream	Enable	Tick / Untick
			Resolution	640x480 / 320x240

		FPS	1 ~ 20 (Default 10)
		Video Code Type	H.265 / H.264
		Video Code Level	Main Profile / Baseline / High Profile
		Bitrate Control	CBR / VBR
		Bitrate Mode	Predefined / User Defined
		Bitrate	8 / 16 / 24 / 32 / 48 / 64 / 80 / 96 / 128 / 160 / 192 / 224 / 256 / 320 / 384 / 448 / 512 / 640 / 768 / 896 / 1024 / 1280 / 1536
		Audio	Untick / Tick
		I Frame Interval	1 ~ 80 (Default 20)
		Refresh / Save	
	Email Settings	Email	Untick / Tick
		Encryption	Disable / SSL / TLS / Auto
		SMTP Port	25 / Customise
		SMTP Server	Customise
		User Name	Customise
		Password	Customise
		Sender Email	Customise
		Receiver1	Customise
		Receiver2	Customise
		Receiver3	Customise
		Interval	1Min / 3Min / 5Min / 10Min
		Refresh / Save / Test Email / Cancel	
	ZIP DDNS	DDNS	Untick / Tick
		Server	NO_IP / DYNDNS
		Host Name	Customise
		Username	Customise
		Password	Customise
	IP Filter	Refresh / Save / Add / Del	
		Filter Mode	Allow all IP connections / Allow the selected IP connections / Block the selected IP connections
	RTSP Port	RTSP	Tick / Untick
		RTSP Port	1240 / Customise
		Anonymous Login	Untick / Tick (No username or password required)
		Instruction: rtsp://IP:Port/ch01/A A:0(MainStream), 1(SubStream), 2(MobileStream)	
		Refresh / Save	
Alarm	Motion Detection	Enable	Untick / Tick
		Sensitivity	1 ~ 8 (Default 3)

		Alarm Out	Untick / Tick		
		Latch Time	5S / 10S / 20S / 30S		
		Post Recording	5S / 10S / 20S / 30S		
		Send Email	Untick / Tick		
		Enable Record	Tick / Untick		
		Refresh / Save			
	Alarm Settings	Alarm Input	OFF / NC / NO		
		Latch Time	5S / 10S / 20S / 30S		
		Send Email	Untick / Tick		
		Alarm Out	Untick / Tick		
		Enable Record	Untick / Tick		
		Post Recording	0S / 5S / 10S / 20S / 30S		
	Refresh / Save				
	Lens	Enable	Tick / Untick		
		Sensitivity	1 ~ 6 (Default 3)		
		Send Email	Untick / Tick		
		Alarm Out	Untick / Tick		
		Latch Time	5S / 10S / 20S / 30S		
Refresh / Save					
Device	SD Card	SD Card	Auto / Close		
		Overwrite			
		Refresh / Save			
	Audio Settings	Enable Audio	Untick / Tick		
		Output Volume	0 ~ 10 (Default 5)		
		Input Volume	0 ~ 10 (Default 5)		
		Audio Code Type	G711A / G711U / G726 16K		
		Refresh / Save			
	Log	Major Type	Selectable	Search	
		Start Time	Selectable		
		End Time	Selectable		
	System	Date/ Time	System Time	Customise	
Date Format			DD/MM/YYYY / YYYY/MM/DD / MM/DD/YYYY		
Time Format			24Hour / 12Hour		
DST / NTP / Synchronize					
Daylight Saving Time			Tick / Untick		
Daylight Saving Time			Week / Date		
Time Offset			1Hour / 2Hour		
Start Time			Customise		
End Time			Customise		
Refresh / Save					
Users		Select User	Username	Customise	
	Password		Customise		

			Confirm	Customise	
			Active	Tick / Untick	
			Password	Tick / Untick	
			Refresh / Save		
	Info	Device Name			
		Serial No.			
		Hardware Version			
		Software Version			
		IE Client Version			
		MAC Address			
		Refresh			
Tools	Firmware Update	Upgrade file path			
		Scan			
		Upgrade			
	Load Default	Camera	Tick / Untick		
		Record	Untick / Tick		
		Network	Untick / Tick		
		Alarm	Untick / Tick		
		Device	Tick / Untick		
		System	Tick / Untick		
		Tools	Tick / Untick		
		Smart	Tick / Untick		
		Simple / All / Save			
	Reboot	Auto Reboot	Untick / Tick		
		Reboot	Customise		
		Refresh / Save / Reboot			
	Import and Export	Import File	Scan / Import		
		Export Path	Scan / Import		
Smart	Detection	PID	Name	Perimeter Intrusion Detection (PID)	
			Switch	Untick / Tick	
			Latch Time	5S / 10S / 20S / 30S	
			Post Recording	5S / 10S / 20S / 30S	
			Sensitive	1 / 2 / 3 / 4	
			Scene	Indoor / Outdoor	
			Alarm Out	Tick / Untick	
			Send Email	Untick / Tick	
			Detection Type	Pedestrian &/or Vehicle	
			Rule Number	1 / 2 / 3 / 4	
			Rule Switch	Untick / Tick	
			Rule Type	A>B / A<B / A<>B	
			Enable Record	Untick / Tick	
			Refresh / Save		
	LCD		Name	Line Crossing Detection (LCD)	
			Switch	Untick / Tick	

			Latch Time	5S / 10S / 20S / 30S
			Post Recording	5S / 10S / 20S / 30S
			Sensitive	1 / 2 / 3 / 4
			Scene	Indoor
			Alarm Out	Tick / Untick
			Send Email	Untick / Tick
			Detection Type	Pedestrian &/or Vehicle
			Rule Number	1 / 2 / 3 / 4
			Rule Switch	Untick / Tick
			Rule Type	A>B / A<B / A<>B
			Enable Record	Untick / Tick
			Refresh / Save	
		PD & VD	Name	Pedestrian Detection (PD&VD)
			Switch	Untick / Tick
			Latch Time	5S / 10S / 20S / 30S
			Post Recording	5S / 10S / 20S / 30S
			Sensitive	0 ~ 100 (Default 60)
			Alarm Out	Untick / Tick
			Send Email	Untick / Tick
			Snap Mode	Interval Mode / Realtime Mode / Default
			Snap Num	1 / 2 / 3 / Unlimited
			Snap Frequency	2 / customise
			Min Pixel	64 ~ 1080 (Default 64)
			Detection Type	Pedestrian &/or Vehicle
			Detection Mode	Motion Mode / Static Mode
			Detection Range	Full Screen / Customize
			Enable Record	Untick / Tick
			Refresh / Save	
		FD	Name	Face Detection (FD)
			Switch	Untick / Tick
			Latch Time	5S / 10S / 20S / 30S
			Post Recording	5S / 10S / 20S / 30S
			Sensitive	0 ~ 100 (Default 60)
			Alarm Out	Untick / Tick
			Send Email	Untick / Tick
			Face Enhance	Untick / Tick
			Snap Mode	Interval Mode / Realtime Mode / Optimal Mode
			Apply Mode	Frontal View / Multi Angle / Customize
			Snap Num	1 / 2 / 3 / Unlimited
			Snap Frequency	2 / customize
			Min Pixel	32 ~ 1080 (Default 32)

			Detection Mode	Motion Mode / Static Mode
			Rule Kind	Rect / Line
			Detection Range	Full Screen / Customize
			Enable Record	Untick / Tick
			Refresh / Save	

6 Extra Resources

6.1 ZipNVR.com Website

The Zip NVR has a range of information on the cameras and NVRs, manuals, software, tools and support:-

www.zipdvr.com

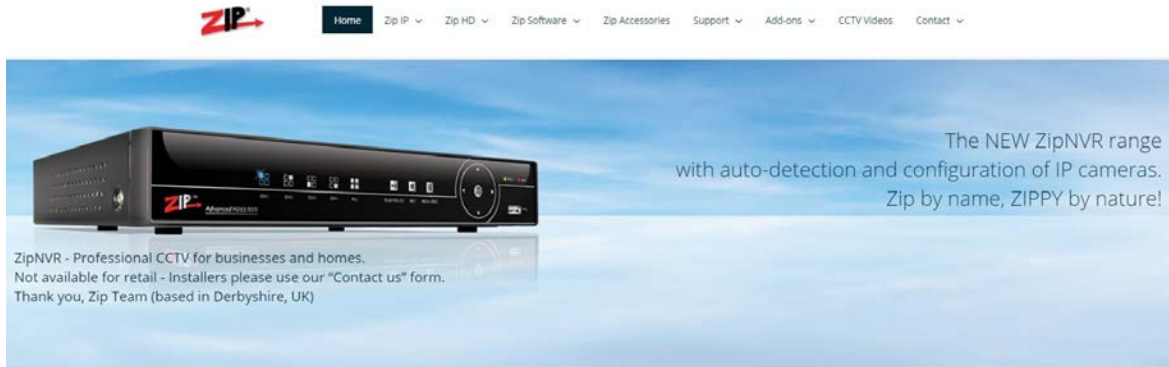

6.2 Adding IP Cameras

How to guide on Adding IP Cameras:-

www.zipdvr.com/howto/TIP459-How-To-Add-IP-Cameras.html

6.3 ZIP Firmware

Firmware for the ZIP products are available online:-

www.zipdvr.com/firmware.html

Compare the firmware in the product against that available online.

AI Face Recognition is available on these model NVRs:- ZIP108, ZIP116, ZIP208, ZIP308, ZIP216 and ZIP226.

7 General Maintenance

- Routinely clean the camera to prevent dust build up as this can effect the performance of the camera. It is recommended to use a damp non-abrasive microfibre cloth.
- Routinely check the connections for power and data to ensure no water ingress and corrosion.
- Check that the cameras are firmly attached to the wall or mounting bracket.
- Check playback in the recorder to ensure the camera is recording and triggering properly.

8 Specification

8.1 IPCAI020

Image Sensor	1/2.8" Progressive CMOS
Resolution	2MP 1920(H)×1080(V)
Lens Type	3.7mm Pinhole
Shutter	1/5 ~ 1/20000s
Day/Night	Electronic
Min. Illumination	0.1 Lux
Video Compression	H.264 / H.265
Video Bitrate	8Kbps ~ 8 Mbps
Stream Options	Mainstream, SubStream & MobileStream
Smart Feature	Pedestrian and Vehicle Detection, Facial Detection
System Compatibility	ONVIF (Profile S, Profile G)
Connection	RJ45 10M / 100M Ethernet PoE
SD Card	No SD card slot
Audio (RCA)	1 Input / 1 Output
Input Voltage	PoE or 12V DC 150mA (PSU Required)
Consumption	4W Max
Operating Temperature	From -30 to 55 deg°C
Use	Internal Use

9 Conditions

All specifications are approximate. System Q Ltd reserves the right to change any product specifications or features without notice. Whilst every effort is made to ensure that these instructions are complete and accurate, System Q Ltd cannot be held responsible in any way for any losses, no matter how they arise, from errors or omissions in these instructions, or the performance or non-performance of the equipment that these instructions refer to.



This symbol on the products and/or accompanying documents means that used electronic equipment must not be mixed with general household waste. For treatment, recovery and recycling please return this unit to your trade supplier or local designated WEE/CG0783SS collection point as defined by your local council.

© Copyright 2020

Zip is a registered trademark of System Q Ltd, Chesterfield. Derbyshire. S40 2WB

Index

- 2 -

2.1mm 3

- A -

AI Smart Features 6

Alarm 3

Audio 3

- C -

Checking 27

Cleaning 27

Connection 4

Connections 3

Consumption 28

- D -

Dimensions 3

Download 1

DVR 26

- E -

Extras 1

- F -

Facial Detection 15

Facial Recognition 15

Firmware 26

- I -

IP Rating 28

- L -

Lens 28

Line Crossing Detection 10

- M -

Maintenance 27

Manual 26

- N -

NVR 4, 26

- O -

Options 4

- P -

Pedestrian Detection 12

Perimeter Intrusion Detection 8

PoE Switch 4

- R -

RJ45 3

- S -

SD Card 28

Setup 4

Size 3

Software 1

Specification 26, 28

- T -

TIPS 26

Tools 1

- V -

Vehicle Detection 12

Voltage 28

- Z -

Zip 26

ZipFinder 1