



ZIP AI IP Camera

IPCAI535

© 2021 System Q Ltd

[ZipNVR.com](http://ZipNVR.com)

# Table of Contents

<b>Part 1 Introduction</b>	<b>1</b>
1 Key Features .....	1
2 Essential Tools and ZipFinder .....	1
<b>Part 2 Connections and Dimensions</b>	<b>3</b>
1 IPCAI535 Vandal Dome 2.8-12mm .....	3
<b>Part 3 Mounting and SD Card Installation</b>	<b>4</b>
1 Dome .....	4
<b>Part 4 Setup Options</b>	<b>5</b>
1 PoE ZIP NVR .....	5
2 Non-PoE ZIP NVR .....	6
<b>Part 5 Setup and AI Features</b>	<b>7</b>
1 PID = Perimeter Intrusion Detection .....	9
2 LCD = Line Crossing Detection .....	11
3 PD & VD = Pedestrian Detection and Vehicle Detection .....	13
4 FD = Facial Detection .....	16
<b>Part 6 Browser Menu Settings</b>	<b>20</b>
<b>Part 7 Motorised Zoom &amp; Focus</b>	<b>27</b>
1 ZIP NVR and DVR .....	27
2 Standalone .....	27
<b>Part 8 Extra Resources</b>	<b>28</b>
1 ZipNVR.com Website .....	28
2 Adding IP Cameras .....	28
3 ZIP Firmware .....	28
<b>Part 9 General Maintenance</b>	<b>29</b>
<b>Part 10 Specification</b>	<b>30</b>
1 IPCAI535 .....	30
<b>Part 11 Conditions</b>	<b>31</b>
<b>Index</b>	<b>32</b>

# 1 Introduction

The ZIP AI Cameras provide triggering with smart detection features such as *line crossing*, *pedestrian detection*, *facial detection*.

Only one smart detection feature can be enabled at any given time.

*Facial recognition* can be set when connected to a compatible ZIP NVR with iSENSE firmware.

In order to use the ZIP AI cameras with a ZIP NVRs the latest iSENSE firmware is required, please see [Extra Resources](#)<sup>28</sup>.

## 1.1 Key Features

- Alarm input and output\*
- Audio input and output\*
- Supports H264 and H265
- Supports ONVIF (Profile S, Profile G, Profile T)
- SD card\*
- Perimeter intrusion
- Line crossing
- Pedestrian and vehicle detection
- Facial detection
- IP66 (*Excluding the IPCAI020*)

*\*On selected models*

## 1.2 Essential Tools and ZipFinder

To install this product you will need:

- Laptop / Windows PC
- Screwdriver
- Drill
- Hammer
- ZIP NVR or DVR
- PoE Switch / 12V DC power supply
- Ethernet CAT5/5e/6 Cable

## ZipFinder - IP Camera Configuration Tool

ZipFinder is a Windows PC software for discovering and configuring IP cameras a network.

Use ZipFinder on non-PoE installs, to help problem solving issues such as forgotten or unknown IP Addresses.

To download visit [ZipNVR.com](http://ZipNVR.com)

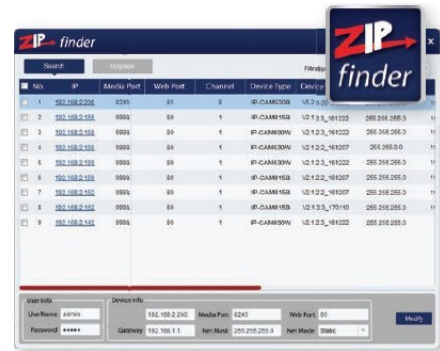

## 2 Connections and Dimensions

### 2.1 IPCAI535 Vandal Dome 2.8-12mm

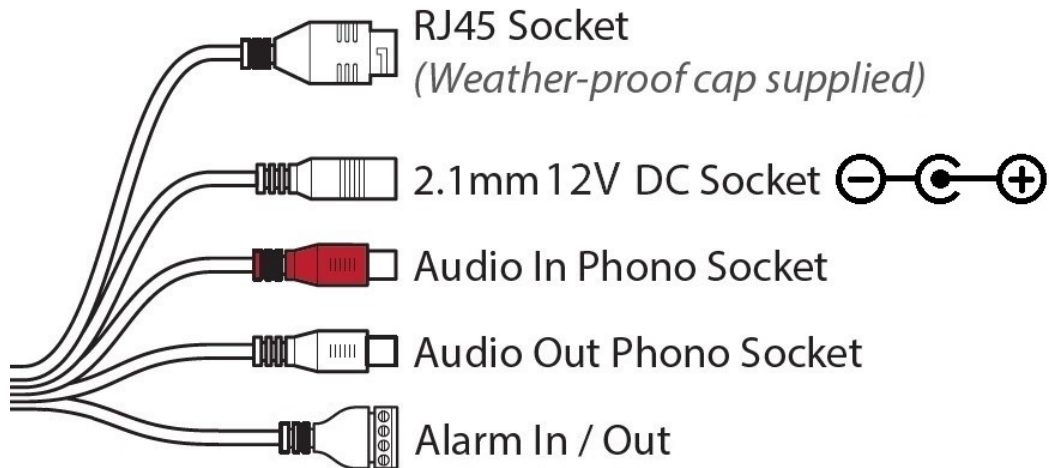

#### Powering the camera

**Option 1** - Power the camera from 12V DC (via the 2.1mm DC Socket), the current consumption is 400mA. The camera is polarity sensitive so connections must be correctly made.

**Option 2** - Power the camera using a PoE 48V RJ45 Socket

When connecting to a **ZIP PoE NVR** plug the camera directly into the NVRs built in PoE switch.



\*Dimensions Exclude Bracket

### 3 Mounting and SD Card Installation

Note:-  
IPCAI020 does not have an SD card slot.

For local recording on the camera itself an SD card must be installed.

Recording time will vary dependent upon: SD card size and encoding settings

**32GB SD Card  $\approx$  31 hours**

**64GB SD Card  $\approx$  62 hours**

**128GB SD Card (MAX)  $\approx$  124 hours**

The camera can be set to only record when triggered via *motion detection*, *alarm input* or *AI smart*, this maximises the recording time achievable.

Remove power from the camera when inserting / removing the SD card.

#### 3.1 Dome

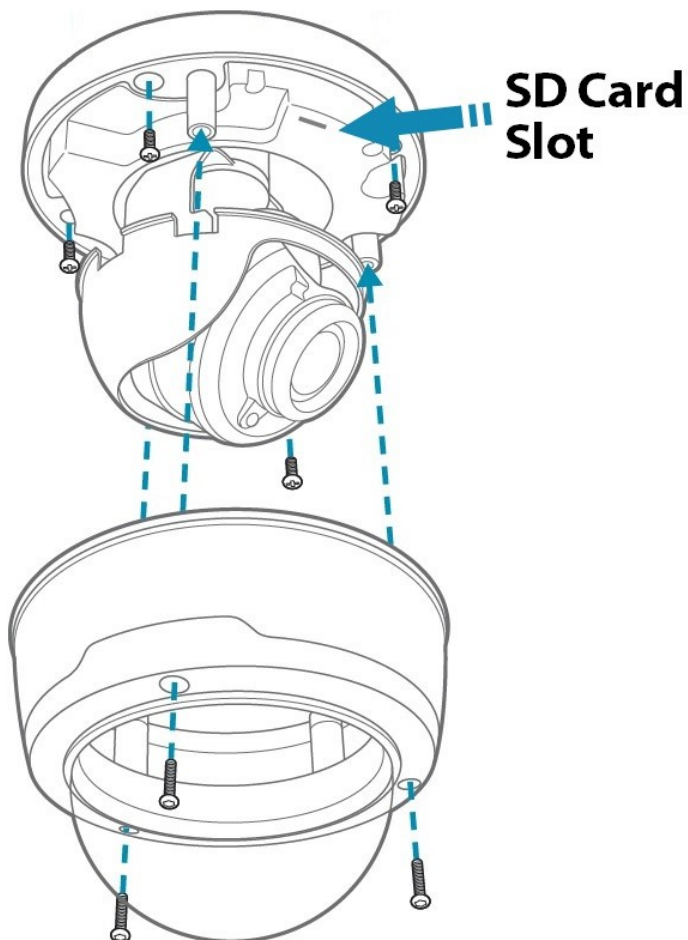

## 4 Setup Options

### 4.1 PoE ZIP NVR

When connecting to a **ZIP PoE NVR** plug the camera directly into the NVR's built in PoE switch.

The camera should automatically become visible after being connected for approximately 1 minute.

The 100m distance for a camera can be increased when the PoE Mode is set to EPoE.

In the menu on a ZIP PoE NVR go to:-

**Video > IP Channels > PoE Mode**

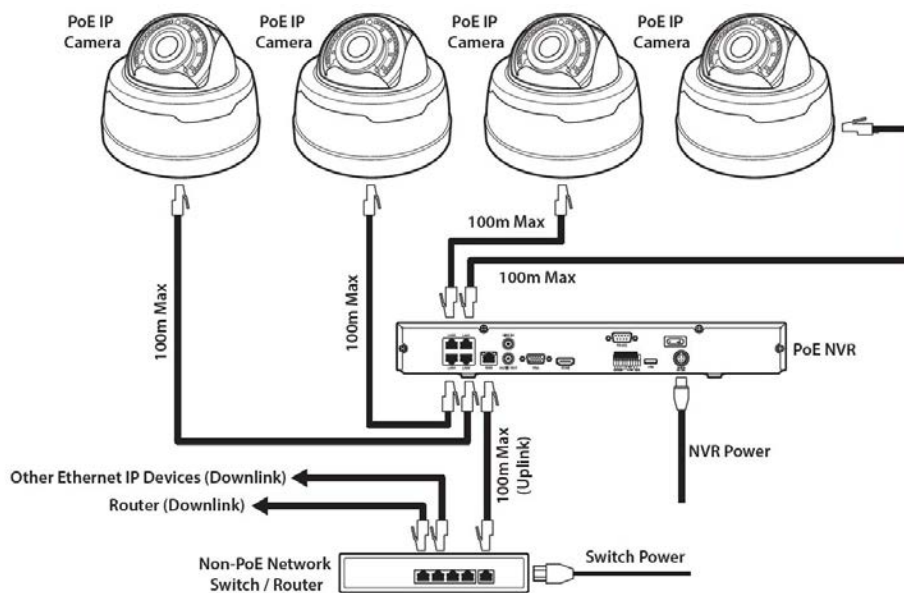

## 4.2 Non-PoE ZIP NVR

When connecting cameras to a **Non-PoE NVR**, they are first connected to an external network switch which is in-turn connected to the NVR as shown below.

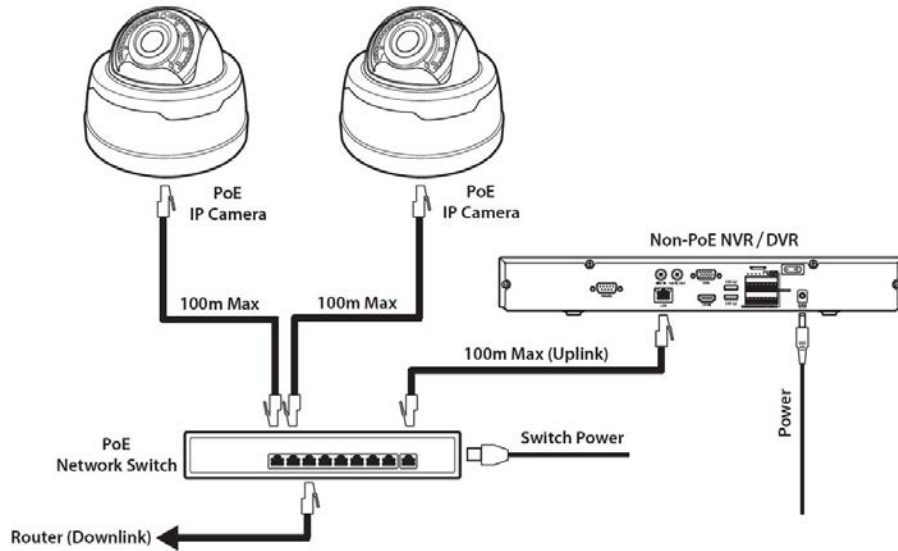

See [Extra Resources](#)<sup>28</sup> for more information on **Adding IP Cameras manually** to a ZIP Recorder.



## 5 Setup and AI Features

The AI smart features can be configured in a ZIP recorder or directly in the browser interface of the camera (standalone)

Only one smart detection feature can be enabled at any given time.

**See the NVR or DVR manual for information on configuring these features with a ZIP recorder.**

Follow the steps below for configuring the settings directly in the camera via a browser for standalone setup.

You will need...

- Windows Based PC/ Laptop connected to router/ PoE switch
- ZipVision Pro App on Mobile Device
- PoE Switch connected to Network/ Router
- Ethernet network cable
- [ZipFinder](#) software, available via this link below:-

[www.softcctv.com/store/Item/Zip-Finder-IP-CCTV-Security-Camera-Discovery-Tool](http://www.softcctv.com/store/Item/Zip-Finder-IP-CCTV-Security-Camera-Discovery-Tool)

1. Plug the camera's RJ45 port with a network cable into a PoE switch

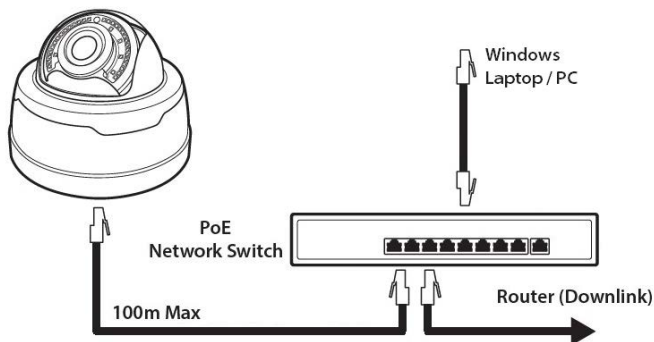

2. Using ZipFinder on a Windows Based PC/ Laptop **Search** and then tick the camera



3. Select Net Mode = **DCHP**, then click **Modify**

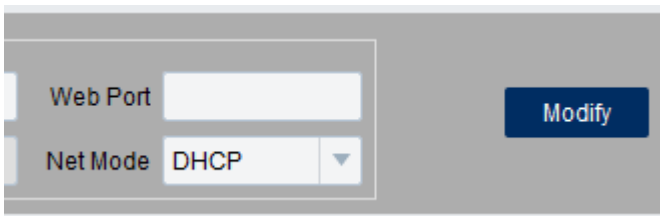

4. **Search** again, to get the updated IP address.

5. **Select** the IP address of the camera, Internet Explorer will pop-up, and ask to download and install the plug-in.

6. **Download, install** and follow the steps for the plug-in installation, then re-load the browser by **selecting** the IP address again.

5. Login to the IP Camera, the **default** login details are:-

User Name	<b>admin</b>
Password	<b>777777</b>

6. Go to **Remote Setting > Smart > Detection**

## 5.1 PID = Perimeter Intrusion Detection

Perimeter intrusion detection can be set to trigger an alarm event when movement is detected in a set area.

Smart ▸ Detection

---

PID
LCD
PD&VD
FD

Name Perimeter Intrusion Detection (PID)

Switch

Latch Time

Post Recording

Sensitive

Scene

Alarm Out

Send Email

Detection Type  Pedestrian  Vehicle

Rule Number

Rule Switch

Rule Type

Enable Record

Refresh
Save



Clear
Clean All

### Key Settings

**Switch** - Tick to enable this feature.

Un-Tick to disable this feature.

**Latch Time** - This determines how long the alarm event is deemed to be activate once triggered. Options are 5, 10, 20 and 30 seconds.

**Post Recording** - This determines how long the camera will record for after the alarm event has ended. Options are 5, 10, 20 and 30 seconds.

**Sensitivity** - Determines how much activity or movement is required to generate an event. Options are **1 - 4**.

**1** = Lowest sensitivity level, a significant amount of movement is needed to trigger

**4** = Highest sensitivity level, only a small amount of moment is needed to trigger

**Scene** - Set for light level location to improve detection. Options are indoor or outdoor.

**Send Email** - Email alert via SMTP can be triggered and send a snapshot image of the event.  
*Note:- Email Settings required to be set up in Network Menu for this feature.*

**Rule Number** - Up to 4 areas can be set independently in the image area. Use this to enable / disable each of the 4 rules.

**Rule Switch** - Tick to enable or disable the detection that rule for the rule number selected.

**Rule Type** - The determines how the direction of moment over the perimeter is handled.

**A to B (A->B)** = Only movement in the direction A to B will trigger.

**B to A (B->A)** = Only movement in the direction B to A will trigger.

**A or B (A<->B)** = Any moment direction over the perimeter will trigger.

**Enable Record** - Tick to enable recording when the event is triggered.

Un-Tick to disable recording when the event is triggered.

## 5.2 LCD = Line Crossing Detection

Line crossing detection can be set to trigger an alarm event when movement is detected across a custom line

Smart ▶ LCD

PID
LCD
PD&VD
FD

Name	Line Crossing Detection (LCD)
Switch	<input checked="" type="checkbox"/>
Latch Time	<input type="text" value="5S"/>
Post Recording	<input type="text" value="5S"/>
Sensitive	<input type="text" value="2"/>
Scene	<input type="text" value="Indoor"/>
Alarm Out	<input checked="" type="checkbox"/>
Send Email	<input type="checkbox"/>
Detection Type	<input type="checkbox"/> Pedestrian <input type="checkbox"/> Vehicle
Rule Number	<input type="text" value="1"/>
Rule Switch	<input type="checkbox"/>
Rule Type	<input type="text" value="A → B"/>
Enable Record	<input type="checkbox"/>

Refresh
Save



Clear
Clean All

### Key Settings

**Switch** - Tick to enable this feature.

Un-Tick to disable this feature.

**Latch Time** - This determines how long the alarm event is deemed to be activate once triggered. Options are 5, 10, 20 and 30 seconds.

**Post Recording** - This determines how long the camera will record for after the alarm event has ended. Options are 5, 10, 20 and 30 seconds.

**Sensitivity** - Determines how much activity or movement is required to generate an event. Options are **1 - 4**

**1** = Lowest sensitivity level, a significant amount of movement is needed to trigger

**4** = Highest sensitivity level, only a small amount of moment is needed to trigger

**Scene** - Set for light level location to improve detection. Options are indoor or outdoor.

**Send Email** - Email alert via SMTP can be triggered and send a snapshot image of the event.  
*Note:- Email Settings required to be set up in Network Menu for this feature.*

**Detection Type** - Tick to enable, options are pedestrian, vehicle. (Both can be enabled simultaneously)

**Rule Number** - Up to 4 areas can be set independently in the image area. Select the number to control the setting of that specific area.

**Rule Switch** - Tick to enable or disable the detection that rule for the rule number selected.

**Rule Type** - The determines how the direction of moment over the perimeter is handled.

**A to B (A->B)** = Only movement in the direction A to B will trigger.

**B to A (B->A)** = Only movement in the direction B to A will trigger.

**A or B (A<->B)** = Any moment direction over the perimeter will trigger.

**Enable Record** - Tick to enable recording when the event is triggered.

Un-Tick to disable recording when the event is triggered.

## 5.3 PD & VD = Pedestrian Detection and Vehicle Detection

Pedestrian detection and vehicle detection can be set to trigger an alarm event in a custom area when it detects pedestrians, vehicles or both.

Smart ▶ PD

PID
LCD
PD&VD
FD

Name	Pedestrian Detection(PD&VD)	
Switch	<input checked="" type="checkbox"/>	
Latch Time	<input type="text" value="5S"/>	▼
Post Recording	<input type="text" value="5S"/>	▼
Sensitivity	<input type="text" value="60"/>	
Alarm Out	<input type="checkbox"/>	
Send Email	<input type="checkbox"/>	
Snap Mode	<input type="text" value="Interval Mode"/>	▼
Snap Num	<input type="text" value="1"/>	▼
Snap Frequency	<input type="text" value="2"/>	s/pic
Min Pixel	<input type="text" value="64"/>	(64-1080)
Detection Type	<input checked="" type="checkbox"/> Pedestrian <input checked="" type="checkbox"/> Vehicle	
Detection Mode	<input type="text" value="Motion Mode"/>	▼
Detection Range	<input type="text" value="Full Screen"/>	▼
Enable Record	<input type="checkbox"/>	

Refresh Save



### Key Settings

**Switch** - Tick to enable this feature.

Un-Tick to disable this feature.

**Latch Time** - This determines how long the alarm event is deemed to be activate once triggered. Options are 5, 10, 20 and 30 seconds.

**Post Recording** - This determines how long the camera will record for after the alarm event has ended. Options are 5, 10, 20 and 30 seconds.

**Sensitivity** - Determines how much activity or movement is required to generate an event. Options are **1 - 4**

**1** = Lowest sensitivity level, a significant amount of movement is needed to trigger

**4** = Highest sensitivity level, only a small amount of moment is needed to trigger

**Send Email** - Email alert via SMTP can be triggered and send a snapshot image of the event.

*Note:- Email Settings required to be set up in Network Menu for this feature.*

**Snap Mode** - Set how the camera will capture thumbnail snapshots when triggered.

**Default** = Will only capture a snapshot when subjects are first detected. Additional thumbnail snapshots will only be captured if the subject leaves the camera's image and returns

**Realtime:** Only capture a snapshot from just before the subject leaves the image.

**Interval Mode** = Customize how many and how often thumbnail snapshots are captured using the **snap num** and **snap frequency** fields.

**Snap Num** - Set how many snapshots are captured for each event

**1** = Will capture a single snapshot when the subject is first detected.

**2** = Will capture a snapshot when the subject is first detected and one further snapshot at the interval as set by the snap frequency, if the subject is still present.

**3** = Will capture a snapshot when the subject is first detected and two further snapshots, one further snapshot at the interval as set by the snap frequency, if the subject is still present.

**Unlimited** = Will continuously capture a snapshot at the interval as set by the snap frequency, if the subject is still present.

**Snap Frequency** - Customise how often the camera will capture a snapshot (in seconds), this is a timer which will remain active as long as the subject is present. If the subject leaves the camera's image and returns a snapshot will be captured and the timer will reset.

**Min Pixel** - Set the minimum trigger size, this can be set as a minimum width between 64 pixels to 1080 pixels. Customize the size depending on how far away the camera is away from the subject.

**Detection Type** - Tick to enable, options are pedestrian and vehicle. (Both can be enabled simultaneously)

**Detection Mode** - How the detection will handle motion and stationary objects.

**Motion mode** = Will only detect moving subjects.

**Static mode** = Will detect moving subjects but also stationary pedestrians and vehicles are in the alarm area.



**Detection Range** - Set the detection area for the image

**Customize** = Customise a defined detection area

**Full Screen** = Set to Monitor the entire image

**Enable Record** - Tick to enable recording when the event is triggered.

Un-Tick to disable recording when the event is triggered.

## 5.4 FD = Facial Detection

Facial detection can be set to trigger an alarm event in a custom area when it detects a face/

AI Face Recognition is available on these model NVRs:- ZIP108, ZIP116, ZIP208, ZIP308, ZIP216 and ZIP226.

Smart ▸ FD

PID
LCD
PD&VD
FD

Name	Face Detection(FD)	
Switch	<input checked="" type="checkbox"/>	
Latch Time	<input type="text" value="5S"/>	▼
Post Recording	<input type="text" value="5S"/>	▼
Alarm Out	<input type="checkbox"/>	
Send Email	<input type="checkbox"/>	
Face Enhance	<input checked="" type="checkbox"/>	
Snap Mode	<input type="text" value="Interval Mode"/>	▼
Apply Mode	<input type="text" value="Frontal View"/>	▼
Snap Num	<input type="text" value="1"/>	▼
Snap Frequency	<input type="text" value="2"/>	s/pic
Min Pixel	<input type="text" value="32"/>	(32-1080)
Detection Mode	<input type="text" value="Motion Mode"/>	▼
Rule Kind	<input type="text" value="Rect"/>	▼
Detection Range	<input type="text" value="Customize"/>	▼
Enable Record	<input type="checkbox"/>	



### Key Settings

**Switch** - Tick to enable this feature.

Un-Tick to disable this feature.

**Latch Time** - This determines how long the alarm event is deemed to be activate once triggered. Options are 5, 10, 20 and 30 seconds.

**Post Recording** - This determines how long the camera will record for after the alarm event has ended. Options are 5, 10, 20 and 30 seconds.

**Send Email** - Email alert via SMTP can be triggered and send a snapshot image of the event. Note:- Email Settings required to be set up in Network Menu for this feature.

**Snap Mode** - Set how the camera will capture thumbnail snapshots when triggered.

**Default** = Will only capture a snapshot when subjects are first detected. Additional thumbnail snapshots will only be captured if the subject leaves the camera's image and returns

**Realtime:** Only capture a snapshot from just before the subject leaves the image.

**Interval Mode** = Customize how many and how often thumbnail snapshots are captured using the **snap num** and **snap frequency** fields.

**Snap Num** - Set how many snapshots are captured for each event

**1** = Will capture a single snapshot when the subject is first detected.

**2** = Will capture a snapshot when the subject is first detected and one further snapshot after the period of time specified in the snap frequency field if the subject is still present.

**3** = Will capture a snapshot when the subject is first detected and two further snapshots, one further snapshot after the period of time specified in the snap frequency field if the subject is still present.

**Unlimited** = Will continuously capture a snapshot at the interval as set by the snap frequency, if the subject is still present.

**Snap Frequency** - Customise how often the camera will capture a snapshot (in seconds), this is a timer which will remain active as long as the subject is present. If the subject leaves the camera's image and returns a snapshot will be captured and the timer will reset.

**Apply Mode** - Customise the face detecting viewing angle for the most accurate face detection.

**Frontal View** - The camera optimizes the detection for straight on.

**Multi Angle** - The camera detects faces at various angles.

**Customise** - Customise to set up bespoke detection angles/

**Roll Range** - How far somebody can tilt their head (ear towards their shoulder) and still be detected as a face. Set the angle from 0 degrees so that a face would have to be straight to 180 degrees so that the face can be tilted 90 degrees to either side.

**Pitch Range** - How far a person can look up or down and still be detected. At 0 degrees the subject would have to be looking directly at the camera. At 180 degrees the subject can be looking towards the ground or towards the sky and could still be detected.

**Yaw Range** - How far somebody can be looking to the side and still be detected. At 0 degrees the subject would have to be looking directly at the camera. At 180 degrees the subject can be side on to the camera and could still be detected.

**Min Pixel** - Set the minimum trigger size, this can be set as a minimum width between 64 pixels to 1080 pixels. Customize the size depending on how far away the camera is away from the subject.

**Detection Mode** - How the detection will handle motion and stationary objects.

**Motion mode** = Will only detect moving subjects.

**Static mode** = Will detect moving subjects but also stationary pedestrians and vehicles are in the alarm area.

**Rule Kind** - Set to trigger an alarm event when a face is detected in a set area or set to trigger an alarm event when a face is detected across a custom line.

**Rect** - Face detection within a set area.

To create a custom detection area;

1. Set the **rule kind** drop down list to **rect**.
2. Set the **detection area** drop down list to **customise**.
3. Click on the camera's image to set the top left corner of the detection area.
4. Click the position to set the bottom left corner.
5. Click the position to set the bottom right corner.
6. Click to set the top right corner of the detection area.

**Line** - Face detection across a custom line. Customise the direction the line is crossed before a capture so the camera will monitor for face on entry or as people exit.

To set up line crossing face detection follow these steps:

1. Set the **rule kind** drop down list to **line**.
2. Click on the camera's image to start the line crossing.
3. Click to stop the line crossing.
4. Finally select which direction a person crosses the line before face detection is triggered from the **rule type** drop down list, from side **A** to **B** (**A->B**) or from side **B** to **A** (**B->A**).

**Detection Range** - Set the detection area for the image.

**Customize** = Customise a defined detection area

**Full Screen** = Set to Monitor the entire image

**Enable Record** - Tick to enable recording when the event is triggered.

Un-Tick to disable recording when the event is triggered.

## 6 Browser Menu Settings

The menu be configured directly in the browser interface of the camera (standalone), in Remote Setting you will find the menu settings.

Camera	OSD Menu	Name	<b>Customise Name</b>	
		Flicker Control	<b>50Hz / 60Hz</b>	
		Transparency	1 ~ 128 (Default <b>64</b> )	
		Show Name	<b>Untick / Tick</b>	
		Show Time	<b>Untick / Tick</b>	
		Refresh / Save		
	Camera Settings	IR-CUT Mode	<b>Auto / Colour Mode / Black White Mode / Schedule (B/W)</b>	
		IR-CUT Delay	1 ~ 36 (Default <b>2</b> )	
		IR-LED	<b>Auto / Off / On</b>	
		Flip	<b>Untick / Tick</b>	
		Mirror	<b>Untick / Tick</b>	
		Corridor Mode	<b>Untick / Tick</b>	
		Angle Rotation	<b>180 / 0</b>	
		Backlight	<b>Untick / Tick</b>	
		3D Noise Reduction	<b>Auto / Disable / Manual</b>	
		DWDR	<b>Untick / Tick</b>	
		HLC	<b>Untick / Tick</b>	
		AGC	1 ~ 128 (Default <b>64</b> )	
		White Balance	<b>Auto / Manual / Indoor</b>	
		Shutter	<b>Auto / Manual</b>	
		Time Exposure (max)	1/5 / <b>1/8</b> / 1/15 / 1/25 / 1/50 / 1/100 / 1/150 / 1/180 / 1/200 / 1/240 / 1/250 / 1/300 / 1/360 / 1/480 / 1/500 / 1/600 / 1/700 / 1/1000 / 1/1500 / 1/2500 / 1/5000 / 1/10000 / 1/12000 / 1/20000 / Flickerless	
		Defog Mode	<b>Disable / Auto / Manual</b>	
		Refresh / Save / Default		
	Privacy Mask	Privacy Mark	<b>Untick / Tick</b>	
		Refresh / Save		
	ROI	Stream Type	<b>MainStream / SubStream / MobileStream</b>	
		Region ID	1 ~ 8	
		Enable Region	Disable / Enable	
		ROI Level	<b>Worst / worse / bad / normal / better / best</b>	
		Non-ROI Fps (1-19)	<b>12</b>	
		Refresh / Save		
	Record	Record Settings	Stream Mode	<b>MainStream / SubStream</b>
			Record	<b>Tick / Untick</b>
PreRecord			<b>Tick / Untick</b>	

	Normal Schedule	<b>Customise Schedule</b>			
		Refresh / Save / Default			
	Event Schedule	<b>Customise Schedule</b>			
		Refresh / Save / Default			
Capture	Capture	Normal Interval	<b>5S</b> / 10S / 30S / 1Min / 10Min / 30Min / 1Hour		
		Alarm Interval	<b>5S</b> / 10S / 30S / 1Min / 10Min / 30Min / 1Hour		
		Auto Capture	<b>Untick</b> / Tick		
		Manual Capture	<b>Untick</b> / Tick		
			Refresh / Save		
	Capture Schedule	<b>Customise Schedule</b>			
Network	Network	Type	<b>DCHP</b> / PPPoE / Static		
		Client Port	<b>8240</b>		
		HTTP Port	<b>80</b>		
		IP Address	<b>192.168.10.1</b>		
		Subnet Mask	<b>255.255.255.0</b>		
		Gateway	<b>192.168.10.254</b>		
		DNS 1	<b>192.168.10.254</b>		
		DNS 2	<b>Untick</b> / Tick		
		UPNP	<b>Untick</b> / Tick		
		Multicast	<b>Untick</b> / Tick		
		P2P Switch	<b>Untick</b> / Tick		
		Port Range	1024 ~ 65535 (Client Port, HTTP Port)		
			Refresh / Save		
		Encoding	Mainstream	Resolution	2592x1944 / 2592x1520 / 2304x1296 / <b>1920x1080</b> / 1280x720
				FPS	1 ~ 20 (Default <b>12</b> )
Video Code Type	<b>H.264</b> / H.265				
Video Code Level	<b>Main Profile</b> / Baseline / High Profile				
Bitrate Control	CBR / VBR				
Bitrate Mode	<b>Predefined</b> / User Defined				
Bitrate	256 / 320 / 384 / 448 / 512 / 640 / 768 / 896 / 1024 / 1280 / 1536 / 1792 / <b>2048</b> / 3072 / 4096 / 5120 / 6144 / 8192				
Audio	<b>Untick</b> / Tick				
I Frame Interval	1 ~ 80 (Default <b>24</b> )				
	Refresh / Save				
	SubStream			Resolution	<b>1280x720</b> / 640x480 / 320x240

			FPS	1 ~ 20 (Default <b>10</b> )
			Video Code Type	<b>H.264</b> / H.265
			Video Code Level	<b>Main Profile</b> / Baseline / High Profile
			Bitrate Control	<b>CBR</b> / VBR
			Bitrate Mode	<b>Predefined</b> / User Defined
			Bitrate	128 / 160 / 192 / 224 / 256 / 320 / 384 / 448 / 512 / 640 / 768 / 896 / <b>1024</b>
			Audio	<b>Untick</b> / Tick
			I Frame Interval	1 ~ 80 (Default <b>20</b> )
			Refresh / Save	
		MobileStream	Enable	<b>Tick</b> / Untick
			Resolution	<b>640x480</b> / 320x240
			FPS	1 ~ 20 (Default <b>10</b> )
			Video Code Type	<b>H.265</b> / H.264
			Video Code Level	<b>Main Profile</b> / Baseline / High Profile
			Bitrate Control	<b>CBR</b> / VBR
			Bitrate Mode	<b>Predefined</b> / User Defined
			Bitrate	8 / 16 / 24 / 32 / 48 / 64 / 80 / 96 / 128 / 160 / 192 / 224 / <b>256</b> / 320 / 384 / 448 / 512 / 640 / 768 / 896 / 1024 / 1280 / 1536
			Audio	<b>Untick</b> / Tick
			I Frame Interval	1 ~ 80 (Default <b>20</b> )
			Refresh / Save	
	Email Settings	Email	<b>Untick</b> / Tick	
		Encryption	<b>Disable</b> / SSL / TLS / Auto	
		SMTP Port	<b>25</b> / Customise	
		SMTP Server	<b>Customise</b>	
		User Name	<b>Customise</b>	
		Password	<b>Customise</b>	
		Sender Email	<b>Customise</b>	
		Receiver1	<b>Customise</b>	
		Receiver2	<b>Customise</b>	
		Receiver3	<b>Customise</b>	
		Interval	1Min / 3Min / 5Min / 10Min	
		Refresh / Save / Test Email / Cancel		
	ZIP DDNS	DDNS	<b>Untick</b> / Tick	
		Server	<b>NO_IP</b> / DYNDNS	



		Host Name	<b>Customise</b>		
		Username	<b>Customise</b>		
		Password	<b>Customise</b>		
	IP Filter	Refresh / Save / Add / Del			
		Filter Mode	Allow all IP connections / Allow the selected IP connections / Block the selected IP connections		
	RTSP Port	RTSP	<b>Tick / Untick</b>		
		RTSP Port	<b>1240 / Customise</b>		
		Anonymous Login	<b>Untick / Tick</b> (No username or password required)		
		Instruction: rtsp://IP:Port/ch01/A A:0(MainStream), 1(SubStream), 2(MobileStream)			
		Refresh / Save			
	Alarm	Motion Detection	Enable	<b>Untick / Tick</b>	
			Sensitivity	1 ~ 8 (Default <b>3</b> )	
			Alarm Out	<b>Untick / Tick</b>	
Latch Time			<b>5S / 10S / 20S / 30S</b>		
Post Recording			<b>5S / 10S / 20S / 30S</b>		
Send Email			<b>Untick / Tick</b>		
Enable Record			<b>Tick / Untick</b>		
Refresh / Save					
Alarm Settings		Alarm Input	<b>OFF / NC / NO</b>		
		Latch Time	<b>5S / 10S / 20S / 30S</b>		
		Send Email	<b>Untick / Tick</b>		
		Alarm Out	<b>Untick / Tick</b>		
		Enable Record	<b>Untick / Tick</b>		
		Post Recording	<b>0S / 5S / 10S / 20S / 30S</b>		
Refresh / Save					
Lens		Enable	<b>Tick / Untick</b>		
		Sensitivity	1 ~ 6 (Default <b>3</b> )		
		Send Email	<b>Untick / Tick</b>		
		Alarm Out	<b>Untick / Tick</b>		
		Latch Time	<b>5S / 10S / 20S / 30S</b>		
Refresh / Save					
Device	SD Card	SD Card	<b>Auto / Close</b>		
		Overwrite			
		Refresh / Save			
	Audio Settings	Enable Audio	<b>Untick / Tick</b>		
		Output Volume	0 ~ 10 (Default <b>5</b> )		
		Input Volume	0 ~ 10 (Default <b>5</b> )		
		Audio Code Type	<b>G711A / G711U / G726 16K</b>		
		Refresh / Save			
	Log	Major Type	Selectable	Search	
		Start Time	Selectable		

		End Time	Selectable		
System	Date/ Time	System Time	<b>Customise</b>		
		Date Format	<b>DD/MM/YYYY / YYYY/MM/DD / MM/DD/YYYY</b>		
		Time Format	<b>24Hour / 12Hour</b>		
		<b>DST / NTP / Synchronize</b>			
		Daylight Saving Time	<b>Tick / Untick</b>		
		Daylight Saving Time	<b>Week / Date</b>		
		Time Offset	<b>1Hour / 2Hour</b>		
		Start Time	<b>Customise</b>		
		End Time	<b>Customise</b>		
		Refresh / Save			
	Users	Select User	Username	<b>Customise</b>	
			Password	<b>Customise</b>	
			Confirm	<b>Customise</b>	
			Active	<b>Tick / Untick</b>	
			Password	<b>Tick / Untick</b>	
			Refresh / Save		
	Info	Device Name			
		Serial No.			
		Hardware Version			
Software Version					
IE Client Version					
MAC Address					
Refresh					
Tools	Firmware Update	Upgrade file path			
		Scan			
		Upgrade			
	Load Default	Camera	<b>Tick / Untick</b>		
		Record	<b>Untick / Tick</b>		
		Network	<b>Untick / Tick</b>		
		Alarm	<b>Untick / Tick</b>		
		Device	<b>Tick / Untick</b>		
		System	<b>Tick / Untick</b>		
		Tools	<b>Tick / Untick</b>		
		Smart	<b>Tick / Untick</b>		
	Simple / All / Save				
	Reboot	Auto Reboot	<b>Untick / Tick</b>		
		Reboot	<b>Customise</b>		
		Refresh / Save / Reboot			
	Import and Export	Import File	Scan / Import		
		Export Path	Scan / Import		
	Smart	Detection	PID	Name	Perimeter Intrusion Detection (PID)

			Switch	Untick / Tick
			Latch Time	5S / 10S / 20S / 30S
			Post Recording	5S / 10S / 20S / 30S
			Sensitive	1 / 2 / 3 / 4
			Scene	Indoor / Outdoor
			Alarm Out	Tick / Untick
			Send Email	Untick / Tick
			Detection Type	Pedestrian &/or Vehicle
			Rule Number	1 / 2 / 3 / 4
			Rule Switch	Untick / Tick
			Rule Type	A>B / A<B / A<>B
			Enable Record	Untick / Tick
			Refresh / Save	
		LCD	Name	Line Crossing Detection (LCD)
			Switch	Untick / Tick
			Latch Time	5S / 10S / 20S / 30S
			Post Recording	5S / 10S / 20S / 30S
			Sensitive	1 / 2 / 3 / 4
			Scene	Indoor
			Alarm Out	Tick / Untick
			Send Email	Untick / Tick
			Detection Type	Pedestrian &/or Vehicle
			Rule Number	1 / 2 / 3 / 4
			Rule Switch	Untick / Tick
			Rule Type	A>B / A<B / A<>B
			Enable Record	Untick / Tick
			Refresh / Save	
		PD & VD	Name	Pedestrian Detection (PD&VD)
			Switch	Untick / Tick
			Latch Time	5S / 10S / 20S / 30S
			Post Recording	5S / 10S / 20S / 30S
			Sensitive	0 ~ 100 (Default 60)
			Alarm Out	Untick / Tick
			Send Email	Untick / Tick
			Snap Mode	Interval Mode / Realtime Mode / Default
			Snap Num	1 / 2 / 3 / Unlimited
			Snap Frequency	2 / customise
			Min Pixel	64 ~ 1080 (Default 64)
			Detection Type	Pedestrian &/or Vehicle
			Detection Mode	Motion Mode / Static Mode
			Detection Range	Full Screen / Customize
			Enable Record	Untick / Tick

			Refresh / Save
		FD	Name
			Face Detection (FD)
			Switch
			<b>Untick</b> / Tick
			Latch Time
			<b>5S</b> / 10S / 20S / 30S
			Post Recording
			<b>5S</b> / 10S / 20S / 30S
			Sensitive
			0 ~ 100 (Default <b>60</b> )
			Alarm Out
			<b>Untick</b> / Tick
			Send Email
			<b>Untick</b> / Tick
			Face Enhance
			<b>Tick</b> / Untick
			Snap Mode
			<b>Interval Mode</b> / Realtime Mode / Optimal Mode
			Apply Mode
			<b>Frontal View</b> / Multi Angle / Customize
			Snap Num
			<b>1</b> / 2 / 3 / Unlimited
			Snap Frequency
			<b>2</b> / customize
			Min Pixel
			32 ~ 1080 (Default <b>32</b> )
			Detection Mode
			<b>Motion Mode</b> / Static Mode
			Rule Kind
			<b>Rect</b> / Line
			Detection Range
			<b>Full Screen</b> / Customize
			Enable Record
			<b>Untick</b> / Tick
			Refresh / Save

## 7 Motorised Zoom & Focus

The vari-focal motorised zoom and focus is controlled electronically.

To control, this will differ depending on the setup of the camera, if being used with a ZIP recorder or standalone.

### 7.1 ZIP NVR and DVR

When using a ZIP NVR and DVR the zoom and focus for the motorised lens is controlled from PTZ control options on the live view.

To access the Control Menu via coaxitron:-

1. Click on the image in Live view
2. Click on the PTZ button at the bottom of the screen

Use the **zoom +** and **zoom -**, to zoom in and out.

The camera will automatically focus once the zoom button is released.

Focus can also be set manually using the **focus +** and **zoom -**.

### 7.2 Standalone

When using the camera standalone the zoom and focus for the motorised lens is controlled from PTZ control options on the live view on the browser

Find the PTZ button at the top right in **live**.

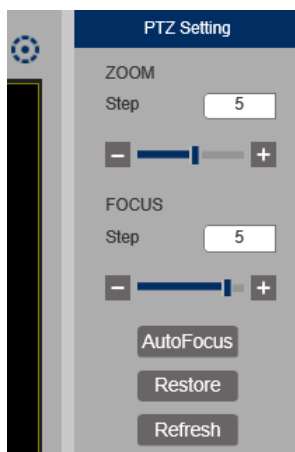

Use the **zoom +** and **zoom -**, to zoom in and out.

The camera will automatically focus once the zoom button is released.

Focus can also be set manually using the **focus +** and **zoom -**.

## 8 Extra Resources

### 8.1 ZipNVR.com Website

The Zip NVR has a range of information on the cameras and NVRs, manuals, software, tools and support:-

[www.zipdvr.com](http://www.zipdvr.com)

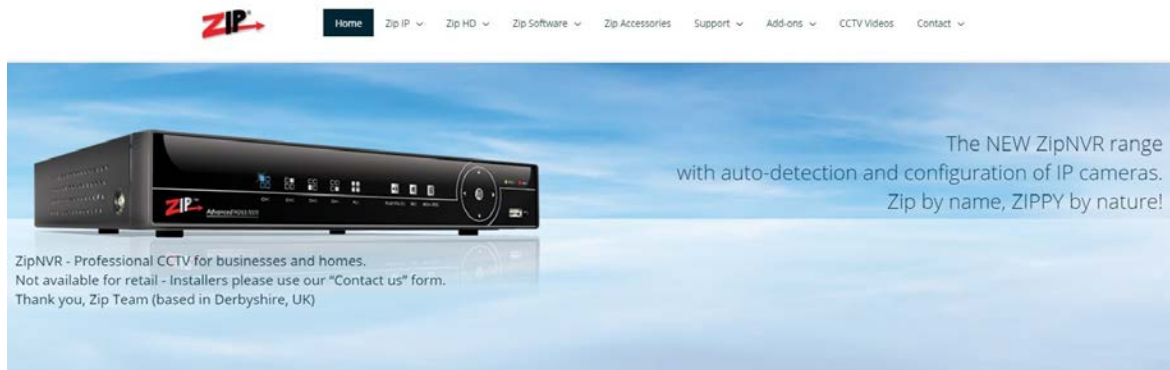

### 8.2 Adding IP Cameras

How to guide on Adding IP Cameras:-

[www.zipdvr.com/howto/TIP459-How-To-Add-IP-Cameras.html](http://www.zipdvr.com/howto/TIP459-How-To-Add-IP-Cameras.html)

### 8.3 ZIP Firmware

**Firmware** for the ZIP products are available online:-

[www.zipdvr.com/firmware.html](http://www.zipdvr.com/firmware.html)

Compare the firmware in the product against that available online.

AI Face Recognition is available on these model NVRs:- ZIP108, ZIP116, ZIP208, ZIP308, ZIP216 and ZIP226.

## 9 General Maintenance

- Routinely clean the camera to prevent dust build up as this can effect the performance of the camera. It is recommended to use a damp non-abrasive microfibre cloth.
- Routinely check the connections for power and data to ensure no water ingress and corrosion.
- Check that the cameras are firmly attached to the wall or mounting bracket.
- Check playback in the recorder to ensure the camera is recording and triggering properly.

## 10 Specification

### 10.1 IPCAI535

Image Sensor	1/ 2.7" Progressive CMOS
Resolution	5MP 2592(H)×1944(V)
Lens Type	2.8- 12mm Motorised
Shutter	1/5 ~ 1/20000s
Day/Night	Mechanical (True Day-Night)
Min. Illumination	0 (With IR On)
IR Range	Up to 40m
Digital Noise Reduction	3D DNR
Video Compression	H.264 / H.265
Video Bitrate	8Kbps ~ 8Mbps
Stream Options	Mainstream, SubStream & MobileStream
Smart Feature	Perimeter Intrusion, Line Crossing, Pedestrian and Vehicle Detection, Facial Detection, Facial Recognition
System Compatibility	ONVIF (Profile S, Profile G, Profile T)
Connection	RJ45 10M / 100M Ethernet PoE
SD Card	Micro SD Card Slot (up to 128GB)
Alarm	1 Input / 1 Output
Audio (RCA)	1 Input / 1 Output
Input Voltage	PoE or 12V DC 400mA (PSU Required)
Consumption	8W Max
Operating Temperature	From -30 to 60 deg°C
Backlight Control	BLC / D-WDR
Use	IP66 For External Use



## 11 Conditions

*All specifications are approximate. System Q Ltd reserves the right to change any product specifications or features without notice. Whilst every effort is made to ensure that these instructions are complete and accurate, System Q Ltd cannot be held responsible in any way for any losses, no matter how they arise, from errors or omissions in these instructions, or the performance or non-performance of the equipment that these instructions refer to.*



*This symbol on the products and/or accompanying documents means that used electronic equipment must not be mixed with general household waste. For treatment, recovery and recycling please return this unit to your trade supplier or local designated WEE/CG0783SS collection point as defined by your local council.*

© Copyright 2020

Zip is a registered trademark of System Q Ltd, Chesterfield. Derbyshire. S40 2WB

## Index

### - 2 -

2.1mm 3

### - A -

AI Smart Features 7

Alarm 3

Audio 3

### - C -

Checking 29

Cleaning 29

Connection 5

Connections 3

Consumption 30

### - D -

Dimensions 3

Download 1

DVR 28

### - E -

Extras 1

### - F -

Facial Detection 16

Facial Recognition 16

Firmware 28

### - I -

Installation 4

IP Rating 30

### - L -

Lens 30

Line Crossing Detection 11

### - M -

Maintenance 29

Manual 28

### - N -

NVR 5, 28

### - O -

Options 5

### - P -

Pedestrian Detection 13

Perimeter Intrusion Detection 9

PoE Switch 5

### - R -

Recording 4

RJ45 3

### - S -

SD Card 4, 30

Setup 5

Size 3

Software 1

Specification 28, 30

### - T -

TIPS 28

Tools 1

### - V -

Vehicle Detection 13

Voltage 30

### - Z -

Zip 28

ZipFinder 1