

IPMIT400 & IPMIT450 Wireless Distribution



A cost effective, simple and reliable solution to transmitting IP signals from building to building.

Contents

Introduction.....	3
Powering your IPmitter.....	4
Super WDS – Quick Setup.....	5
Setup via the Web.....	6
Home Screen.....	7
Setup Wizard.....	8
Super WDS Web Setup.....	10
Repeater mode Setup.....	12
AP Mode Setup.....	15
CPE Manage.....	18
WIFI Settings.....	19
WDS Settings.....	20
Repeater Settings.....	21
Mac ACL.....	22
Advanced.....	23
Network Config.....	24
Device Manage.....	27
Reboot.....	28
Modify Password.....	28
Upgrade.....	29
Time.....	29
Log.....	30
Troubleshooting.....	31
Specification.....	34

Introduction

The Pro IPMIT400 is a top of the range IP bridge and boasts an ultra-fast 900Mbps data transfer rate, 5.8GHZ band and also a 48V PoE connection for easy and rapid deployment in PoE systems.

The IPmitter works in 3 modes, Super WDS mode with LED pairing, Repeater mode and AP mode.

IPMIT400 Can be powered using **48 PoE (Not supplied)** or can be powered using 12V DC (Not supplied).

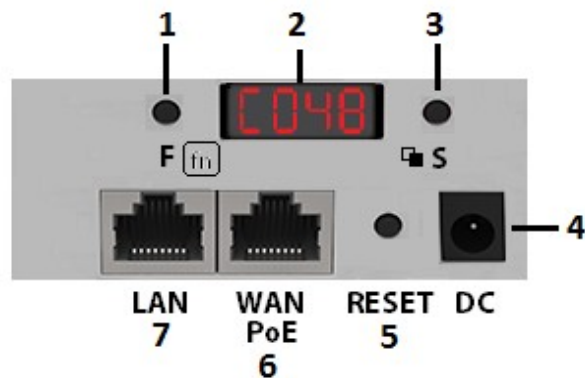

IPMIT400 & 450

The Controls

		IPMIT400 & 450
1	Function Button	Select the desired segment on the LED Display
2	LED Display	Displays WiFi channel number, the last segment of the IP address or power
3	Setting	Change between Host, Client and channel number. Turns the display back on
4	12V DC	12v DC. 2.1mm DC Socket.
5	Reset/Pair	10 Second press to reset. 1 Second press when pairing
6	WAN	Network connection socket. Can be used for 48 PoE power input
7	LAN	Network connection socket.

Powering Your IPmitter

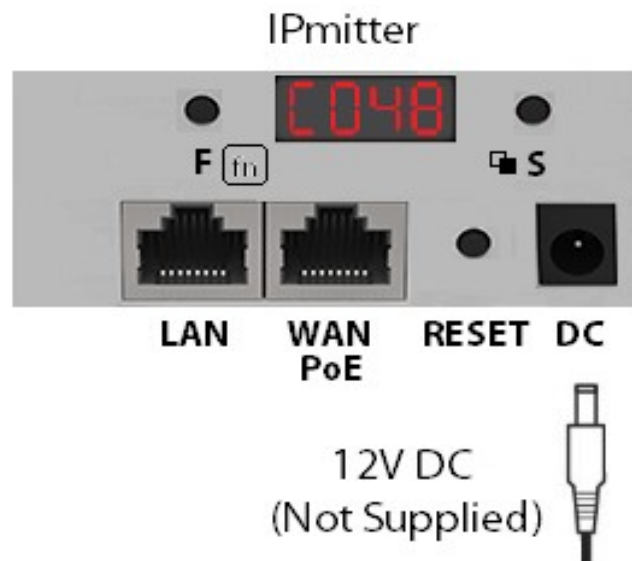
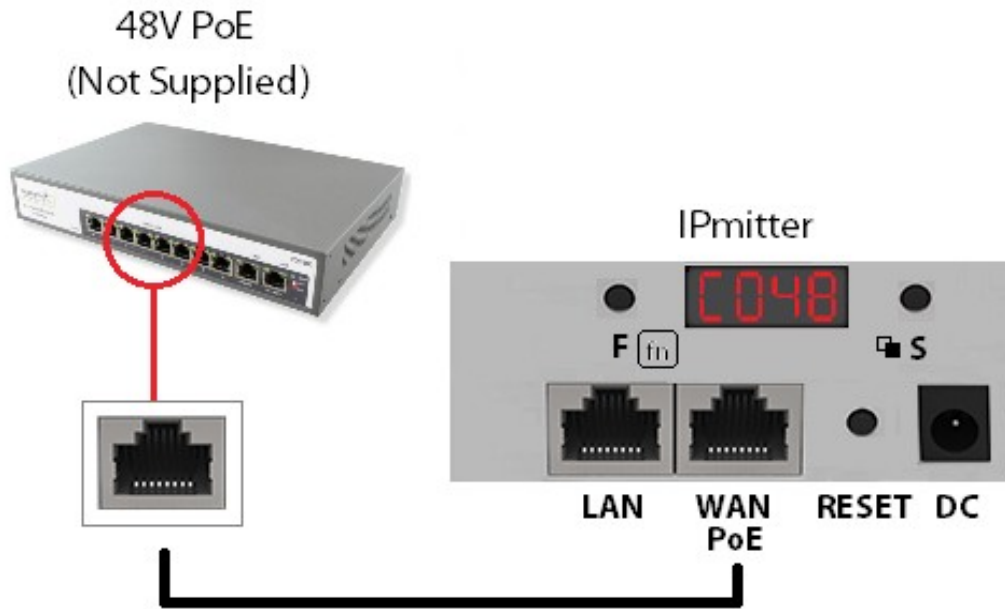

Super WDS – QUICK SETUP

You will need to pair the IPmitters before installing, **the units do not come paired up from factory**. This pairing process is simple on a test bench setup before installing in position. The IPmitter comes set in Super WDS mode. This allows for easy pairing using the LED display.

When powered up the display will show the channel number 048 for 5.8GHz. This is preceded by either an H or C indicating Host (master) or Client (Slave). The default is client(C).

Before pairing one IPmitter needs to be set to H (host), one to C (client) and they both have to be on the same channel number.



Changing to host, setting the channel and pairing

Note – Best practise is to set the **Client** at the “camera end” and the **Host** at your “Network end”. This allows for more Clients to be added at a later date if required.

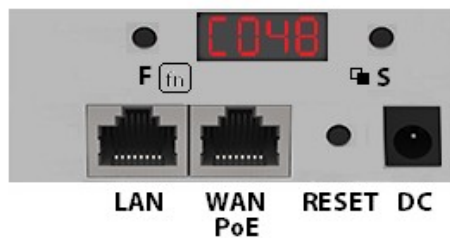

Step 1. Press the F (function) button and the first character will flash press the S (setting) button to change the value.

Step 2. To move to the next character press the F button again and use the S button to change the value.

Step 3. Pressing the F button again when the last character is flashing will make the whole display flash for about 5 seconds to indicate the settings have been saved.

Step 4. Now press the RST (reset) button for 1 second on each IPmitter. The display will change to a P with a rotating segment whilst pairing and will show a value when paired. Pairing can take up to 2.5 minutes.



To add more clients (up to 4) to one host then set the channel on the new client and press the reset buttons on the new client and the Host. They will then pair.

Setup via the WEB Interface

The default settings for the IPmitter

IP Address: 192.168.1.123

Password: ipmitter (lower case)

These are shown on the label on the back of the unit.

The default WiFi key is 66666666

When the IPmitters are in Super WDS mode one IP address will always be on the default and the others will be automatically assigned. The IP address of the unit can be found by pressing the S button until the display changes to Ann the 3 characters after the A indicate the last segment of the IP address. Unless you have changed the IP address the first 3 segments will still be 192.168.1.nnn



192.168.1.123

If the IPmitters are paired in Super WDS mode, then by logging onto the IPmitter at 192.168.1.123 the IP address of other connected IPmitters can be found in CPE Manage.

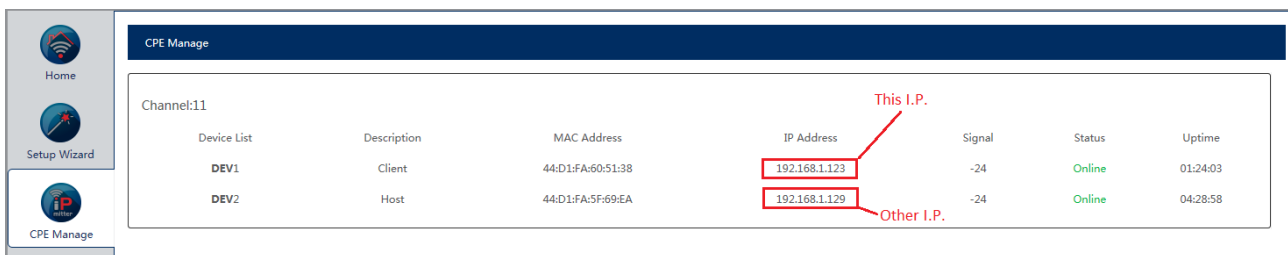

Device List	Description	MAC Address	IP Address	Signal	Status	Uptime
DEV1	Client	44:D1:FA:60:51:38	192.168.1.123	-24	Online	01:24:03
DEV2	Host	44:D1:FA:5F:69:EA	192.168.1.129	-24	Online	04:28:58

The screenshot shows the 'CPE Manage' interface with a table of connected devices. The IP address 192.168.1.123 is highlighted with a red box and labeled 'This I.P.', and 192.168.1.129 is highlighted with a red box and labeled 'Other I.P.'.

Remember. When you connect to the IPmitter your PC/Laptop needs to be on the same subnet.

Home Screen



This screen displays the status information of the IPmitter.

1 Working Mode shows which of the 3 modes the IPmitter is set.

2 Flow shows the data flow from and to the IPmitter.

3 Device Information shows the resource usage in the IPmitter.

4 Status this is mode dependant and shows relevant connection information.

5 Information this shows information on the IPmitter you are viewing.

6 Device Location this allows you to set a name for the IPmitter. This may be seen when connecting from other WiFi devices. Click on the gear icon to add the name.

Setup Wizard

This screen is for changing between the different modes. Just click on the required mode to start the setup wizard. If you want to change the setup for the mode you are already in you can click on the wizard again.



Super WDS Mode

This is used for point to point connection and will work as one-to-one or many-to-one. You can pair



a maximum of 4 clients to one host. This can be set up without the use of a computer using the LED display. One – One

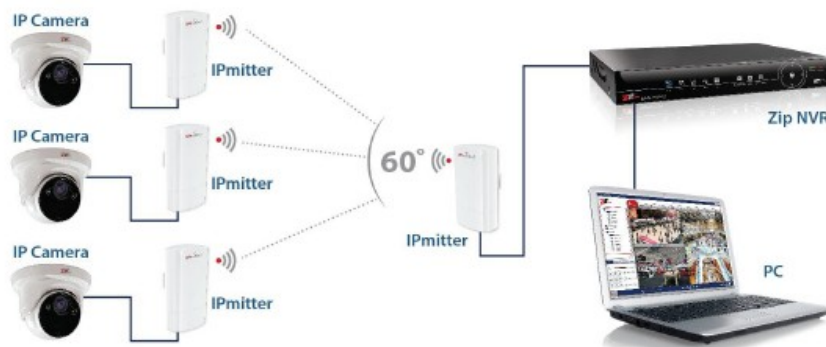

Many – One

Repeater Mode

This is used to extend the range of your WiFi network. The IPmitter is wirelessly connected to your existing network to extend the wireless coverage. This requires logging onto the web interface to setup.



Repeater extending the WiFi coverage and wirelessly adding a camera.

AP Mode

This is used to add wireless networking to a network without wireless or to add wireless networking outside the range of your existing wireless. It requires a wired connection to the existing network.



Adding WiFi to your network

Super WDS Web Setup

Using Setup Wizard to setup Super WDS

Although the IPmitter may already be in Super WDS mode. You can still use the Setup Wizard by clicking on the Super WDS Mode icon.



Step 1 – Connecting other IPmitters

The screenshot shows the 'Super WDS Mode' setup wizard. At the top, a progress bar indicates four steps: 1 (active), 2, 3, and 4. Below the progress bar, the 'WDS Settings' section contains the following fields and controls:

- AP BSSID: 44:D1:FA:5F:DE:D2
- SSID: Wireless 2.4G_5FDED2
- Scan button
- AP BSSID: (empty)
- SSID: (empty)
- Scan button
- AP BSSID: (empty)
- SSID: (empty)
- Scan button
- AP BSSID: (empty)
- SSID: (empty)
- Scan button
- Password: (empty) with a toggle switch set to 'off'
- Next button

Scan this will show a list of available WiFi devices. Although it will show devices not on the same channel you will not be able to connect to them. Selecting a device in the list will add it. The AP BSSID is the MAC address of the selected device and the SSID is the name.

Password this is the password for Super WDS connected devices. It defaults to off but for extra security a password can be added. If used this should be the same in all of your IPmitters and has a minimum of 8 characters.

Step 2 – LAN Settings

The screenshot shows the 'Super WDS Mode' setup wizard. At the top, a progress bar indicates four steps: 1, 2 (active), 3, and 4. Below the progress bar, the 'LAN Settings' section contains the following field and controls:

- IP Mode: GHCP (dropdown menu)
- Back button
- Next button

IP Mode this is used to set the IP address. In Super WDS mode you would normally leave this in GHCP so that IPmitters assign their own IP addresses. It can be set to DHCP and the IPmitter will get network settings from a DHCP server. It can also be set to Static IP if you wish to set a fixed IP address. In static IP CPE manage will not display connected devices.

Step 3 – WiFi Settings

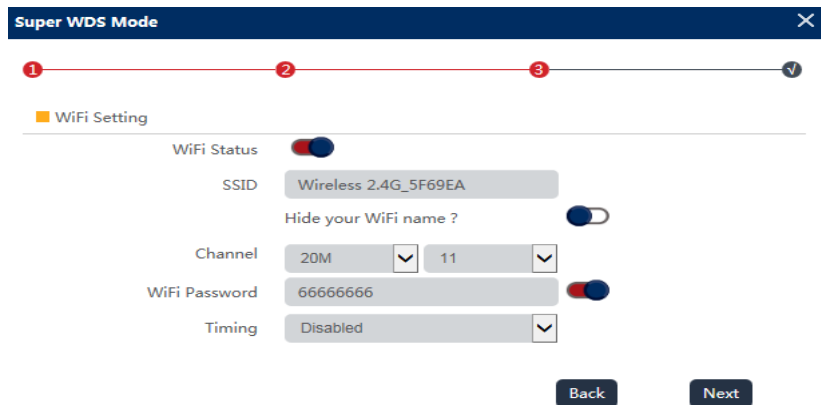

Super WDS Mode

1 2 3 4

WiFi Setting

WiFi Status

SSID Wireless 2.4G_5F69EA

Hide your WiFi name?

Channel 20M 11

WiFi Password 66666666

Timing Disabled

Back Next

WiFi Status turns the WiFi on or off.

SSID is the name displayed when seen by other WiFi devices

Hide your WiFi name? When a wireless device searches the area for the networks it will not be able to detect the WiFi name associated with the router.

WiFi Password this is the password required to Login to IPmitter from another wireless device.

Timing allows for a timed reboot or interval for the IPmitter.

Step 4 – Save configuration

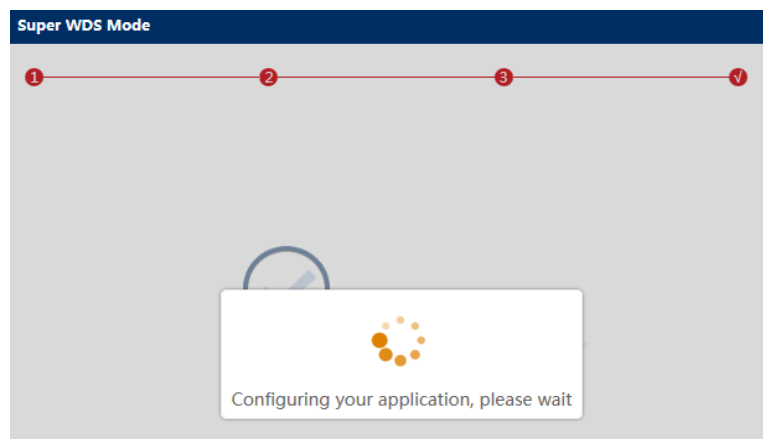

Moving onto step 4 will automatically save the configuration

REPEATER Mode Web Setup



Repeater mode this lets you connect the IPmitter to an existing WiFi network, the IPmitter will then pick up the existing WiFi network and extend the existing wireless network as second network.

- Select Setup Wizard

- Select Repeater Mode



Step 1 – Connecting settings for existing WiFi

The screenshot shows the 'Repeater Mode' configuration window. At the top, there's a progress bar with three steps: 1 (active), 2, and 3. Below the progress bar, there's a section titled 'Repeater Settings'. The settings are as follows:

- Repeater SSID: Repeater (with a 'Scan' button)
- Lock BSSID: [Redacted] (toggle off)
- Encryption: WPA/WPA2PSK_TKIPAES (dropdown menu)
- Password: [Redacted]
- BandWidth: 20M (dropdown menu)
- Pass through: [Redacted] (toggle on)

A 'Next' button is located at the bottom right of the settings area.

Repeater SSID is the WiFi network you want the IPmitter to connect. To find the network you want to connect to press Scan and then select the WiFi network name.

Lock BSSID is the Mac Address of the device you are connecting the IPmitter to, this field is completed automatically.

Encryption is the type of Wireless Encryption used to access the WiFi network.

Password is the password used to access the WiFi network.

Bandwidth is the broadcasting bandwidth which your wireless network uses. This needs to set to match your router/ WiFi Bandwidth.

Pass through is set to off as default, if the IPmitter is only connecting other IPmitter devices then you will need to set this on, otherwise leave this option off.

Step 2 – WiFi Settings for the repeater

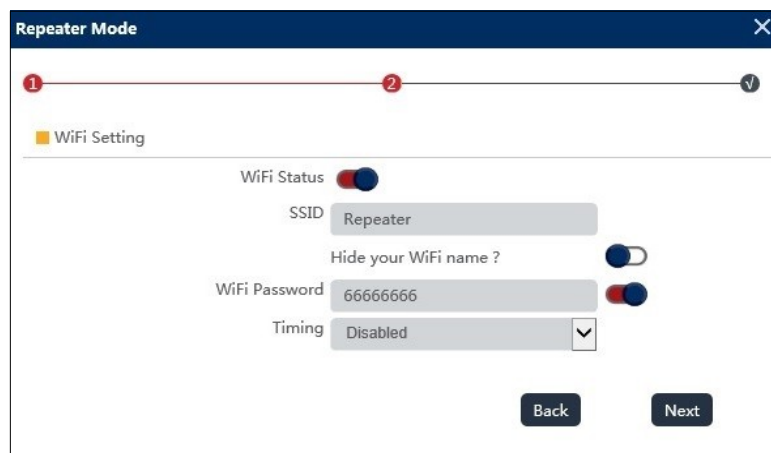

The screenshot shows the 'Repeater Mode' configuration window. At the top, there is a progress bar with three steps: 1 (red), 2 (red), and 3 (grey). Below the progress bar, the 'WiFi Setting' section is highlighted with a yellow square. The settings are as follows:

- WiFi Status:** A toggle switch is turned on (blue).
- SSID:** A text input field contains the word 'Repeater'.
- Hide your WiFi name?:** A toggle switch is turned off (white).
- WiFi Password:** A text input field contains '66666666'.
- Timing:** A dropdown menu is set to 'Disabled'.

At the bottom right, there are two buttons: 'Back' and 'Next'.

WiFi Status turns the WiFi on or off for the repeater itself.

SSID is the name of the WiFi network you will see when you connect to the repeater. This can be the same as the existing WiFi network or unique to the repeater.

Hide your WiFi name? When a wireless device searches the area for the networks it will not be able detect the WiFi name associated with the router.

WiFi Password is the password used to access the Repeater WiFi network. A strong password consists of at least six characters (and the more characters, the stronger the password) that are a combination of letters, numbers and symbols. This can be the same as the existing WiFi network or unique to the repeater.

Timing allows for a timed reboot or interval for the IPmitter.

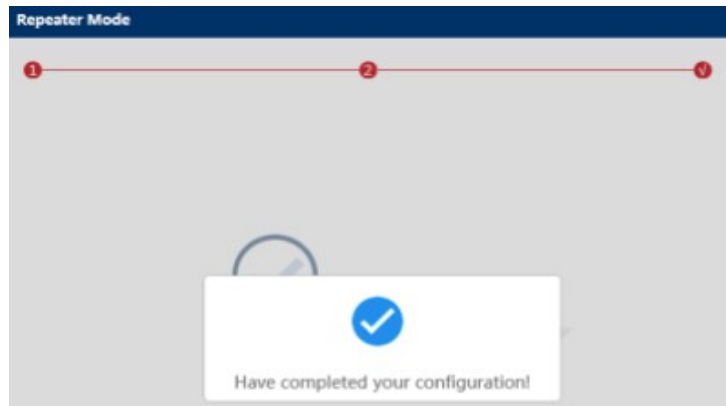
Step 3 – Save configuration

Moving onto step 3 will automatically save the configuration

Applications for Repeater mode:-

Router wireless extender – Extends the existing signal from a wireless router and the rebroadcasts it to create a second network. You can then connect to the WiFi via the repeater which will be a stronger signal than without the repeater.



Access point extender – this can use an existing WiFi access point or IPmitter to then rebroadcast it to create a second network. This means you can connect to the WiFi of the repeater with a stronger signal than just connecting to the Access point.

Limitations:-

Bandwidth is reduced by 50% as there is data being transmitted between the existing WiFi and the Repeater, then from the repeater to the connecting device. Instead of just a connection between the existing WiFi and the device.

AP MODE



AP Mode lets you set the IPmitter as a wireless access point allowing a WiFi device connect to a wired network.

- Select Setup Wizard

- Select AP Mode



Step 1 – LAN Settings

IP Mode can be set to either static or DHCP. Static IP address is a unique fixed address which you can assign to the IPmitter. DHCP will obtain the address from the DCHP server or the router and assign IPmitter with an address from the network.

LAN IP is a unique local IP address of the IPmitter that identifies the device on the local area network.

Subnet is the number that defines a range of IP address that can be used on the network. This should match other devices on the network. The most common subnet mask is 255.255.255.0

Gateway (or default gateway) is a router address connected to the local network that sends packets out of the local network. This is normally the local IP address of your router.

Primary DNS is usually your Gateway (router's) local IP address.

Secondary DNS another DNS server address if the primary DNS fails, a third party DNS address you can use could be 8.8.8.8 and/or 8.8.4.4.

Step 2 – WiFi Setting

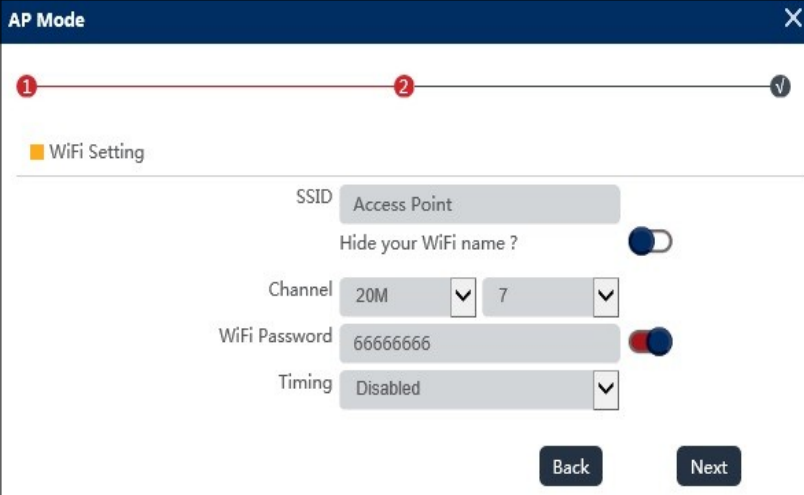

The screenshot shows the 'AP Mode' configuration window for WiFi settings. At the top, there is a progress bar with three markers: a red '1' at the start, a red '2' in the middle, and a grey '3' at the end. Below the progress bar, the 'WiFi Setting' section is visible. It contains the following fields and controls:

- SSID:** A text input field containing 'Access Point'.
- Hide your WiFi name?:** A toggle switch currently turned off (blue).
- Channel:** Two dropdown menus. The first is set to '20M' and the second is set to '7'.
- WiFi Password:** A text input field containing '66666666'.
- Timing:** A dropdown menu set to 'Disabled'.

At the bottom of the form, there are two buttons: 'Back' and 'Next'.

SSID is the name of the WiFi network you will see when you connect to the network.

Hide your WiFi name? When a wireless device searches the area for the networks it will not be able to detect the WiFi name associated with the router.

Channel is the broadcasting channel and bandwidth which your wireless network uses. This would normally be set to 20M/40M for best performance and reliability and allows devices to use the largest bandwidth they support. You may want to use the WiFi Analyzer which can be found on the WiFi Settings page.

WiFi Password is the password used to access the WiFi network. A strong password consists of at least six characters (and the more characters, the stronger the password) that are a combination of letters, numbers and symbols.

Timing allows for a timed reboot or interval for the IPmitter

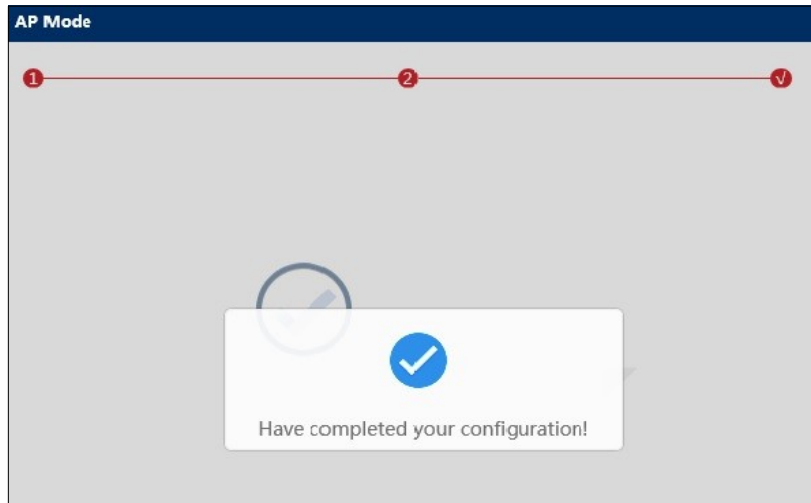
Step 3 – Save configuration

Moving onto step 3 will automatically save the configuration

Applications for AP Mode:-

Standard AP Mode – Connect a router or network the IPmitter to allow for WiFi devices to connect to the network. If the location and devices where you are wanting WiFi has not got a this you can wire the IPmitter to the local area network to transform a wire into wireless which multiple devices can share and connect to.

CPE Manage

The screenshot displays the 'CPE Manage' interface. On the left is a sidebar with navigation icons for Home, Setup Wizard, CPE Manage (highlighted), WiFi Settings, Network Config, and Device Manage. The main content area is titled 'CPE Manage' and shows two tables for 'Channel:11'.

Device List	Description	MAC Address	IP Address	Signal	Status	Uptime
DEV1	Garage	44:D1:FA:5F:DE:D2	192.168.1.123	-26	Online	00:17:52
DEV2	Host	44:D1:FA:5F:69:EA	192.168.1.243	-26	Online	00:37:13

Device List	Description	MAC Address	IP Address	Signal	Status	Uptime
DEV1	Host	44:D1:FA:5F:69:EA	192.168.1.243	0	Online	00:37:13

This screen shows connected devices when in Super WDS Mode. The description will show the Device Location if this has been set in the home screen. Clicking on the I.P. Address will open that address in a new tab in your browser. If the Status shows offline this may be because of an incorrect password if it has been changed from the default.

WiFi Settings

WiFi Settings

WiFi Status turns the WiFi on or off for the repeater itself.

WiFi Analyzer displays a WiFi analyzer so that you can see WiFi devices in your vicinity when choosing a channel.

SSID is the name of the WiFi network you will see when you are connecting.

Hide your WiFi name? When a wireless device searches the area for the networks it will not be able to detect the WiFi name associated with the IPmitter.

BandWidth is the broadcasting bandwidth which your wireless will use. When set to 20/40 it will switch according to the connected device.

Channel is where the WiFi channel is selected. Ideally you should avoid choosing a channel that is already in use.

WiFi Password is the password used to access the IPmitter. This has to be at least 8 characters (and the more characters, the stronger the password) that are a combination of letters, numbers and symbols.

Apply saves the settings for this page.

WDS Settings

WiFi Settings WDS Settings MAC ACL Advanced

WDS Settings

WDS Status

Quick Link

AP BSSID	<input type="text" value="44:D1:FA:5F:DED2"/>	SSID	<input type="text" value="Wireless 2.4G_5FDED2"/>	<input type="button" value="Scan"/>
AP BSSID	<input type="text"/>	SSID	<input type="text"/>	<input type="button" value="Scan"/>
AP BSSID	<input type="text"/>	SSID	<input type="text"/>	<input type="button" value="Scan"/>
AP BSSID	<input type="text"/>	SSID	<input type="text"/>	<input type="button" value="Scan"/>

Password

BandWidth

Channel

WDS Status turns WDS on and off.

Quick Link enables pairing using the LED display and reset button. If you turn this off you will only be able link IPmitters using the web interface.

AP BSSID this is the MAC address of the connected device you are trying to connect to. To edit or delete just click on the address.

SSID this shows the SSID of the connected device. This will be blank if the pairing was done using the IPmitter buttons.

Scan displays a list of WiFi devices. Select the device that you wish to connect and the AP BSSID and SSID will be automatically added.

Password this is the password for Super WDS connected devices. It defaults to off but for extra security a password can be added. If used this should be the same in all of your IPmitters and has a minimum of 8 characters.

BandWidth is the broadcasting bandwidth which your wireless will use. When set to 20/40 it will switch according to the connected device. Changing the bandwidth here will change it in the WiFi Settings.

Channel is where the WiFi channel is selected. Ideally you should avoid choosing a channel that is already in use. Changing the channel here will change it in the WiFi Settings.

WiFi Analyzer displays a WiFi analyzer so that you can see WiFi devices in your vicinity when choosing a channel.

Apply saves the settings for this page.

Repeater Settings

WiFi Settings Repeater Settings MAC ACL Advanced

Repeater Settings

WiFi Status

Repeater SSID

Lock BSSID

Encryption

Password

Pass through

Repeater SSID is the WiFi network you want the IPmitter to connect. To find the network you want to connect to press Scan and then select the WiFi network name.

Lock BSSID is the Mac Address of the device you are connecting the IPmitter to, this field is completed automatically.

Encryption is the type of Wireless Encryption used to access the WiFi network.

Password is the password used to access the WiFi network.

Bandwidth is the broadcasting bandwidth which your wireless network uses. This needs to set to match your router/ WiFi Bandwidth.

Pass through is set to off as default, if the IPmitter is only connecting to other IPmitter devices then you to set this on, otherwise leave this option off.

Apply saves the settings for this page.

MAC ACL - this is the MAC address access list. By default this is disabled but it can be set to allow or prohibit access.

WiFi Settings WDS Settings MAC ACL Advanced

	SN	Name	MAC Address	Mark	Status	Config
--	----	------	-------------	------	--------	--------

Add this add a MAC address for Allowing or Prohibiting. The MAC address can be typed or scanned. Only currently connected devices will show in the Station List when scanned. Mark allows you to enter a name for identifying the device.

The image shows two overlapping windows from a network management interface. The 'MAC ACL' window on the left has a title bar with a close button. It contains a 'Status' toggle switch currently in the 'off' position, a 'MAC Address' input field with a 'Scan' button to its right, and a 'Mark' input field with an 'Apply' button below it. The 'Station List' window on the right also has a title bar with a close button and displays a table of connected devices.

IP Address	MAC Address
192.168.1.94	24:BE:05:26:D0:87
192.168.1.112	10:60:4B:4B:08:09

Add

Delete this deletes the selected MAC addresses.

Apply this applies changes when the access list is changed from Disable to Allow or Prohibit.

Advanced – settings will depend on the operating mode.

WiFi Settings MAC ACL **Advanced**

Advanced

Country Region	Europe (ETSI)	▼	Channel(1-13)
Max Client	64		(Range 0-64 0:No Limit)
WLAN Partition	OFF	▼	
Short GI	ON	▼	
Multicast Fast	ON	▼	
HI-MAX	OFF	▼	
TX Power	100%	▼	

[Apply](#)

Country Region this is set to Europe and cannot be changed. Its shows the available channels for the selected country.

Max Client set the maximum number of connections allowed.

WLAN Partition this stops wireless clients from communicating with each other when switched on.

Short GI short guard interval increase throughput by decreasing the time between symbols. If the signal is poor throughput maybe increased by turning this on to reduce intersymbol interference.

Multicast Fast this is used for to increase speed when streaming.

HI-MAX also known as time division multiple access allows this several users to share the same frequency channel by dividing the signal into different time slots.

TX Power this allows you to adjust the power output of your IPmitter.

Apply saves the settings for this page.

Network Config

The screenshot displays the 'Network Config' page in the IPmitter web interface. The left sidebar contains navigation icons for Home, Setup Wizard, CPE Manage, WiFi Settings, Network Config (selected), and Device Manage. The main content area is divided into two sections: 'LAN Settings' and 'DHCP Server'. In the 'LAN Settings' section, 'IP Mode' is set to 'Static IP'. Below it, 'Lan IP' is 192.168.1.123, 'Subnet' is 255.255.255.0, and 'Gateway', 'Primary DNS', and 'Secondary DNS' are empty. The 'DHCP Server' section has 'DHCP Server' checked, 'Start Address' set to 2, 'Max Number' set to 251, and 'DHCP Lease Time' set to 24(Hour). The 'Assigned IP Number' is 0. There is a 'DHCP List' button and an 'Apply' button at the bottom right.

IP Mode can be set to either Static IP, GHCP or DHCP. If you set a Static IP this has to be a unique address in the same subnet as the rest of your network. DHCP will obtain the address from the DCHP server and assign IPmitter with an address from the network. GHCP is used in Super WDS mode and allows the IPmitters to sort their own IP addresses.

These settings are for Static IP only. In GHCP and DHCP mode no further settings need to be made.

LAN IP is a unique local IP address of the IPmitter that identifies the device on the local area network.

Subnet is the number that defines a range of IP address that can be used on the network. This should match other devices on the network. The most common subnet mask is 255.255.255.0

Gateway (or default gateway) is a router address connected to the local network that sends packets out of the local network. This is normally the local IP address of your router.

Primary DNS is usually your Gateway (router's) local IP address.

Secondary DNS another DNS server address if the primary DNS fails, a third party DNS address you can use could be 8.8.8.8 and/or 8.8.4.4.

DHCP Server setting this on allows the IPmitter to act as a DHCP server. It is important that you only have one DHCP server on your network to avoid networking issues.

These settings will only appear if DHCP Server is turned on.

Start Address this is the first address that the DHCP server will assign. It is the last segment of the subnet.

Max Number this is the maximum number of addresses that the server should assign.

DHCP Lapse Time this is the time a device reserves an address on your network.

Assigned IP Number the number of devices that have had addresses assigned by the server.

DHCP List				
SN	Name	IP Address	MAC Address	DHCP Lease Time
1		192.168.1.7	88:A6:35:4E:AA:A6	0 Day 23 H 59 M 22 S

DHCP List displays a list of devices that have been assigned an IP address. It includes the MAC Address and the time left on the lease.

Apply saves the settings for this page.

Static DHCP also known as DHCP reservation. The DHCP server will always assign the same IP address to devices in this list. This is based on the MAC address of the device.

LAN Settings		Static DHCP			
	SN	IP Address	MAC Address	Mark	Config
<input type="checkbox"/>	1	192.168.1.112	10:60:4B:4B:08:09	Laptop	

[Add](#) [Delete](#) [Apply](#)

Add this add a MAC address for fixing the IP. Both the IP Address can be typed or if the device is already connected then clicking scan will allow you to find the device in a list for selection. Mark allows you to enter a name for identifying the device.

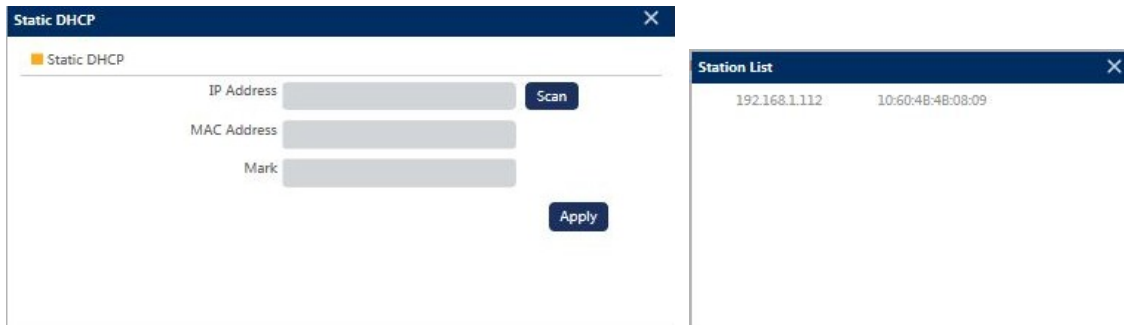

Delete deletes the selected device from the list.

Apply saves changes.

Device Manage

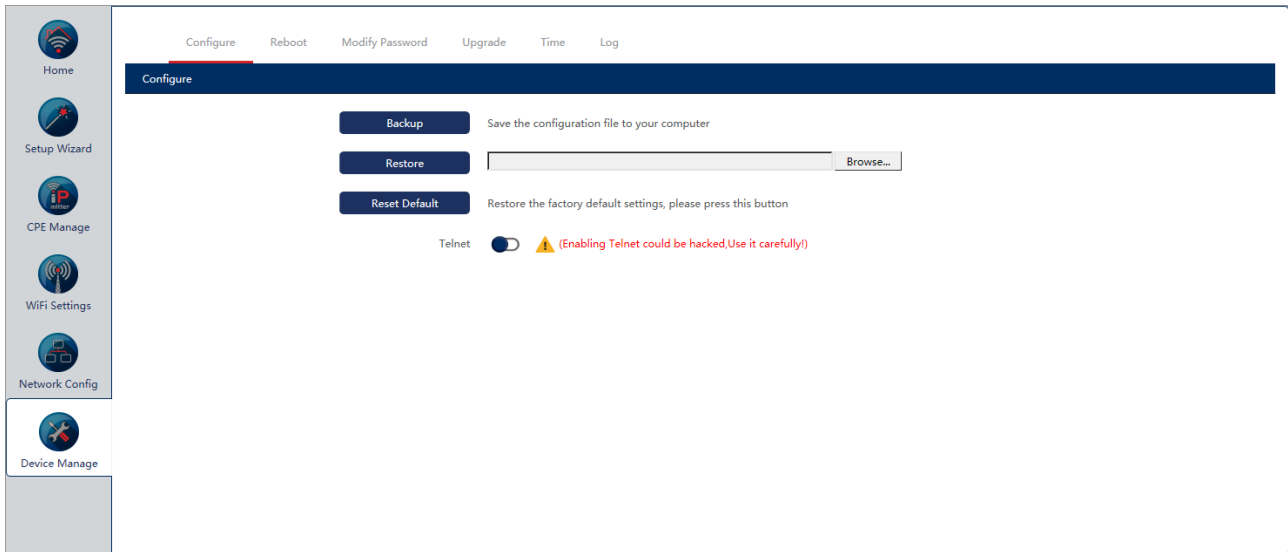

Configure - allows you to back up and restore your configuration as well as defaulting the IPmitter.

Backup saves the configuration to your computer using your web browser download.

Restore loads previously saved configuration.

Reset Default restores the factory default settings.

Telnet allows you to make a telnet connection to the IPmitter. This is not normally used and is best left disabled.

Reboot – for rebooting the IPmitter immediately or scheduled.

The screenshot shows the 'Reboot' configuration page in the IPmitter web interface. At the top, there are navigation tabs: 'Configure', 'Reboot', 'Modify Password', 'Upgrade', 'Time', and 'Log'. The 'Reboot' tab is selected and highlighted. Below the tabs, the page title 'Reboot' is displayed. The configuration options include: a 'Reboot' button; a 'Timed Reboot' toggle switch (currently turned off); a 'Reboot Time' section with a radio button, a day selector (set to 'Wednesday'), and a time selector (set to '3:00'); and a 'Restart Interval' section with a radio button and a dropdown menu (set to '3 Day'). An 'Apply' button is located at the bottom right of the configuration area.

Reboot reboots the IPmitter immediately.

Timed Reboot enables timed rebooting.

Reboot Time allows you to set a day of the week and time to reboot.

Restart Interval allows you to select between 1 and 10 days as the reboot interval.

Apply saves the settings for this page.

Modify Password – allows you to change the login password.

The screenshot shows the 'Modify Password' configuration page in the IPmitter web interface. At the top, there are navigation tabs: 'Configure', 'Reboot', 'Modify Password', 'Upgrade', 'Time', and 'Log'. The 'Modify Password' tab is selected and highlighted. Below the tabs, the page title 'Modify Password' is displayed. The configuration area contains three input fields: 'Old Password', 'New Password', and 'Confirm Password'. An 'Apply' button is located at the bottom right of the configuration area.

Old Password enter the current password here.

New Password enter your new password here.

Confirm Password enter your new password again here.

Apply saves the settings for this page.

Note – If you forget your password you will have to default the IPmitter, using the reset button, to restore the default password.

Upgrade – This allows you to upgrade the firmware if required.

Browse search for the upgrade file.

Upgrade sends the file to the IPmitter and updates the firmware. Care should be taken not to disconnect the power or network when upgrading. It is preferable to use a wired connection to the IPmitter when upgrading.

Time – allows you to set time the on the IPmitter. Used for logs.

Sync With Host will set the time to match the computer. This is only available if NTP is not enabled.

NTP Enable allows the IPmitter to connect to a network time server. The IPmitter has to have internet access for this to work.

Time Zone Select allows you to select your time zone.

Manual IP Settings allows you to enter the IP address of an NTP server if you do not want to select one from the drop down list.

NTP Server this is a list of NTP servers to select from.

Apply saves the settings for this page

Note – If the time is synced with host and NTP is not used then the time will be lost on reboot or power off.

Log

Configure Reboot Modify Password Upgrade Time **Log**

Log

Syslog Server

Log

```

Jan 1 00:00:11 IPMIT200 syslog.info syslogd started: BusyBox v1.22.1
Jan 1 00:00:11 IPMIT200 kern.notice kernel: klogd started: BusyBox v1.22.1 (2018-10-12 16:04:48 CST)
Jan 1 00:00:11 IPMIT200 kern.info kernel: m25p80 spi0.0: w25q64 (8192 Kbytes) (29000000 Hz)
Jan 1 00:00:11 IPMIT200 kern.notice kernel: 5 rtxpart partitions found on MTD device m25p80
Jan 1 00:00:11 IPMIT200 kern.notice kernel: Creating 5 MTD partitions on "m25p80":
Jan 1 00:00:11 IPMIT200 kern.notice kernel: 0x000000000000-0x00000230000 : "boot+cfg+linux"
Jan 1 00:00:11 IPMIT200 kern.notice kernel: 0x00000230000-0x00000770000 : "rootfs"
Jan 1 00:00:11 IPMIT200 kern.notice kernel: 0x00000770000-0x00000780000 : "config"
Jan 1 00:00:11 IPMIT200 kern.notice kernel: 0x00000780000-0x00000800000 : "database"
Jan 1 00:00:11 IPMIT200 kern.notice kernel: 0x00000800000-0x00000800000 : "all"
Jan 1 00:00:11 IPMIT200 kern.info kernel: PPP generic driver version 2.4.2
Jan 1 00:00:11 IPMIT200 kern.info kernel: NET: Registered protocol family 24
Jan 1 00:00:11 IPMIT200 kern.info kernel: MIPPE/MPPC encryption/compression module registered
Jan 1 00:00:11 IPMIT200 kern.warn kernel: Realtek WLAN driver - version 1.7 (2015-10-30)(SVN:328)
Jan 1 00:00:11 IPMIT200 kern.warn kernel: Adaptivity function - version 9.3.4
Jan 1 00:00:11 IPMIT200 kern.warn kernel: MACHAL_version_init
Jan 1 00:00:11 IPMIT200 kern.warn kernel: RFE TYPE = 2
Jan 1 00:00:11 IPMIT200 kern.warn kernel: RFE TYPE = 2
Jan 1 00:00:11 IPMIT200 kern.warn kernel: RFE TYPE = 2
Jan 1 00:00:11 IPMIT200 kern.warn kernel: RFE TYPE = 2
Jan 1 00:00:11 IPMIT200 kern.warn kernel: RFE TYPE = 2
Jan 1 00:00:11 IPMIT200 kern.warn kernel: RFE TYPE = 2
Jan 1 00:00:11 IPMIT200 kern.info kernel: u32 classifier

```

Export Delete Refresh Apply

Log turns logging on or off.

Syslog Server If you have a Syslog Server on the network then you can enter the IP address here and the logging will be sent to server.

Export this will export the log file in a compressed format (.rar). If you wish to read the file you will need to extract it and view it as text.

Delete deletes the log.

Refresh refreshes the log screen.

Apply saves the settings for this page

Troubleshooting

Pairing Issues

1. Check the signal strength on the LED display at the Host and Client IPmitter. *Please see page 33 for different sites effecting the range.*
2. Check the SYS light at the Host and Client IPmitter > If the SYS light is not lit then check your 48V PoE source or 12V DC source.
3. Check the WAN or LAN indicator Host and Client IPmitter > This will light up if a device connected and powered correctly. *Please note this may not just be a power issue for the device connected but the cable connecting the IPmitter and the devices may be wired incorrectly or have a fault.*

Signal strength of P-095.

1. Check the pairing > The signal strength of P-095 shows they have not paired up correctly. Reset both IPmitters, holding the R (reset) button down on both IPmitters for 10 seconds. Once both units have booted back up, then try the pairing process again.
2. Between P-070 and P-095 is too low for transmission > Try the pairing process with the devices closer together.

Can't see my IP Camera via the IPmitter.

1. Check the IP Camera works fine without the IPmitter > This ensures the setup for your NVR/ network has the correct settings, set up a test network via a switch plugged into your NVR/ network.
2. Check the LED displays on both IPmitters > see **Pairing Issues**
3. Check signal strength of the IPmitters > see **Signal strength of P-095**
3. Ensure your IP Camera is powered and connected.
4. Check IP address settings, your IP Cameras needs match your NVR/ network.

The IPmitter is not powering up.

1. Check the power supply for your IPmitter > The 48V PoE needs to be connected to the WAN/ PoE Ethernet socket.
2. If you using the 2.1mm DC Socket then check the DC Socket is properly plugged into the IPmitter and powered.

Poor streaming quality or slow connection speeds

1. Check if the WiFi channel set on the IPmitter > If there are devices using the same channels (*Like a Router*) then change the channel on the IPmitters.
2. Check the bandwidth which the IPmitter has available > Please note some video streaming devices like IP Cameras can use a considerable amount of bandwidth and data speed.
3. Move the IPmitter away from other WiFi devices > This should reduce the interference and help provide a more stable transmission between the IPmitters.



1. The signal will not go through hills. The density of the hill and water it contains in the soil absorbs the microwave signal.



2. The signal will go through branches of trees but remember that microwave signals will be attenuated greatly by water. Leaves and plants are full of water so the distance is reduced. To help, best avoid the trees and/ or fit a IPmitter with a longer transmission range.

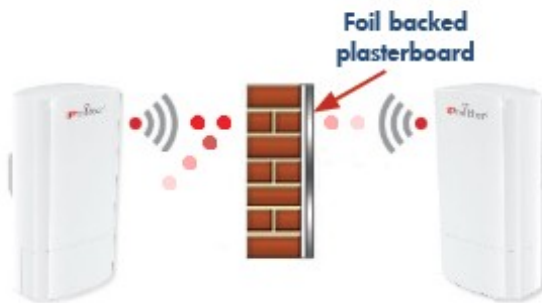

3. In Modern building sometimes the structure is lined with 'FOIL'. This can reflect or 'ground' the wireless signal. Avoid transmitting through such 'shields'. If wiring is not an option then use a more powerful IPmitter to help or mount the unit on the exterior of a building.



4. Remember if you are installing on a day when the weather is good the signal will be good. However, when it is raining heavily the microwave signal will be absorbed by the rain and reduce the distance. So always keep the distance to a minimum, or allow for the use of a more powerful IPmitter



5. On Some site you may have other RF Equipment that can interfere with the the IPmitters and reduce the range and cause poor performance. The best solution will be to change the WiFi channel on the IPmitter, install a more powerful IPmitter, or avoid other RF equipment or routers.

Specification

IPMIT400 & 450

LAN Port 1 Speed	10Mbps / 100Mbps
LAN Port 2 Speed	10Mbps / 100Mbps / 1000Mbps
Frequency	5.8Ghz
Wireless Data Speed	900Mbps
Wireless Standard	IEEE802.11AC/A
PoE Voltage	48V
12V Input Option	Yes
Max Tx Distance	2000Km (Recommend 1Km)
Easy Pair Technology	Yes
Support 1 - 1	Yes
Support 1 - Many	Yes
Modes	Access Point / Bridge / Repeater
Mounting	Wall Or Pole (Not Supplied)
Dimensions	260 x 88 x 56mm

This symbol on the products and/or accompanying documents means that used electronic equipment must not be mixed with general household waste. For treatment, recovery and recycling please return this unit to your trade supplier or local designated collection point as defined by your local council.



WEE/CG0783SS

All specifications are approximate. IPmitter.com reserves the right to change any product specification or features without notice. Whilst every effort is made to ensure that these instructions are complete and accurate, IPmitter.com cannot be held responsible in any way for any losses, no matter how they arise, from errors or omissions in these instructions, or the performance or non-performance of the camera or other equipment that these instructions refer to.