

## Features

- 10.4" screen
- Video and Audio In
- Internal Amplifier & Speakers
- 1v p~p composite video input/output
- Analogue VGA input (640x480 @ 60Hz)
- LCD Profile Ratio 4:3
- Stand and wall mount options
- Multi-Language OSD menu
- Brightness, Contrast and Volume Controls
- Power consumption 17.2W
- Horizontal & Vertical display adjustment



These monitors are designed primarily for CCTV systems which should be connected to the composite video input. The 15 pin analogue VGA input supports 640 x 480 @ 60Hz only. The monitors come complete with a stand but can also be mounted with a VESA 100 x100 wall bracket.

## SAFETY PRECAUTIONS

- Please do not remove the back cover of the LCD monitor as there are no user-serviceable parts inside and the warranty will be treated as void.
- Do not place your hands, face or objects close to the ventilation openings of the monitor. The case gets hot from air released through the ventilation openings and may cause burns. Also do not obstruct the ventilation openings.
- Always disconnect all cables before moving the monitor as monitor connections and cables can be easily damaged.
- Never expose the monitor to rain or moisture.
- Please install the monitor away from excessive dust, high temperatures, moisture and direct sunlight.
- Always disconnect power when cleaning the unit and do not use liquid or aerosol cleaners. Only use a slightly damp cloth for cleaning.
- If the picture displayed is abnormal, always switch off the monitor and disconnect from the power source. Ensure the video input is correctly connected and then reconnect the power to the monitor.

## Operation ~ Front Panel

1. MENU      Activate OSD menu
2. DOWN     Move down menu
3. POWER    Switch monitor on/off
4. Power Light   Green LED when powered on
5. UP        Move up menu
6. AUTO     Auto optimise in PC mode

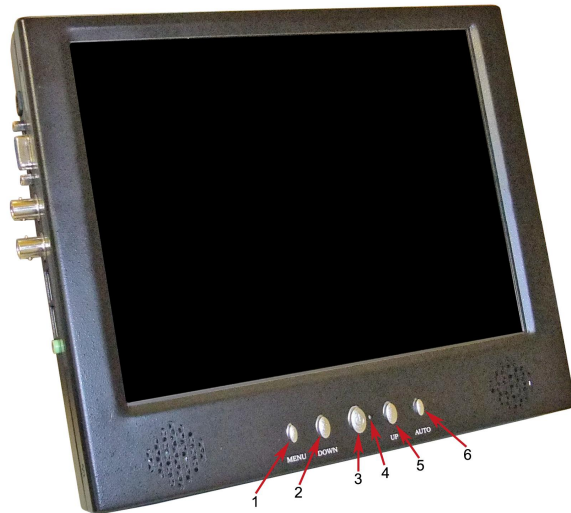

## Input/Output Connections

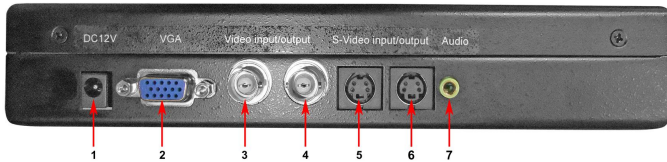

1. 12vDC 5A Input
2. VGA Input
3. Video In (Composite)
4. Video Out (Composite)
5. S-Video In
6. S-Video Out
7. Audio In (Phono)

## ON SCREEN MENU

The On Screen Menu display allows the user to change image and associated settings to provide the best possible performance by this monitor.

The following main settings can be adjusted:

COLOR, POSITION, OSD MENU, LANGUAGE, MISC., EXIT

Press the menu button to access the OSD Menu.

### Special Note:

If no VGA is displayed and menu corruption occurs, check that the maximum resolution of 640 x 480 @ 60Hz is not exceeded.

### Main Menu

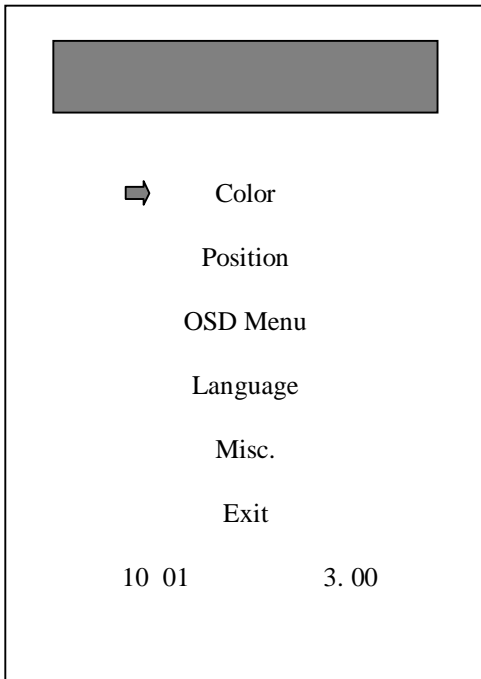

### Color

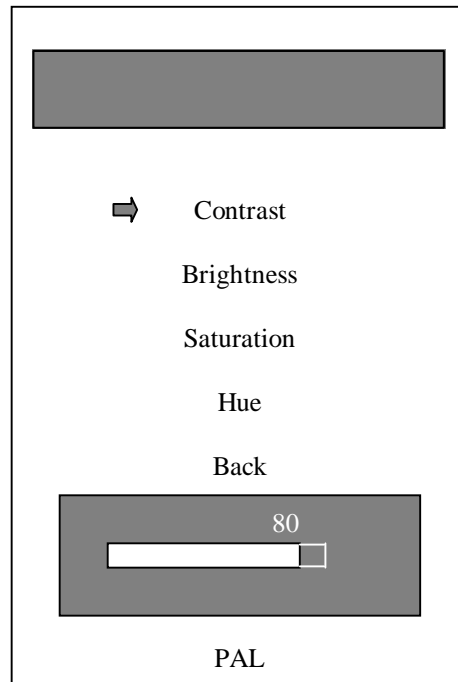

**Color** Allows adjustment of Contrast, Brightness, Saturation and Hue. Press menu to enter. Press menu after selection. Press Back to return to Main Menu followed by Exit.

### Main Menu

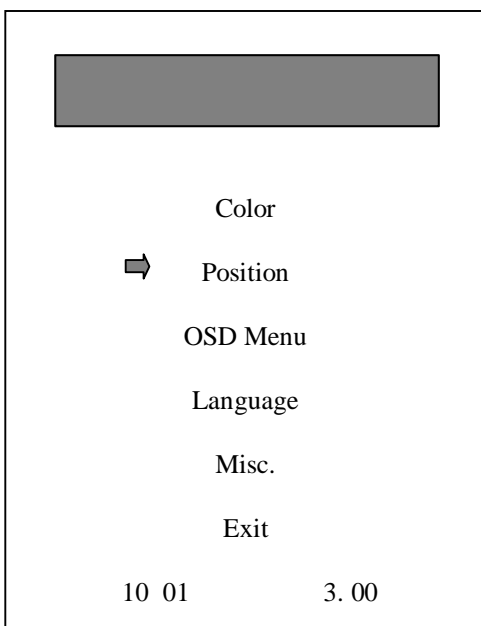

### Position

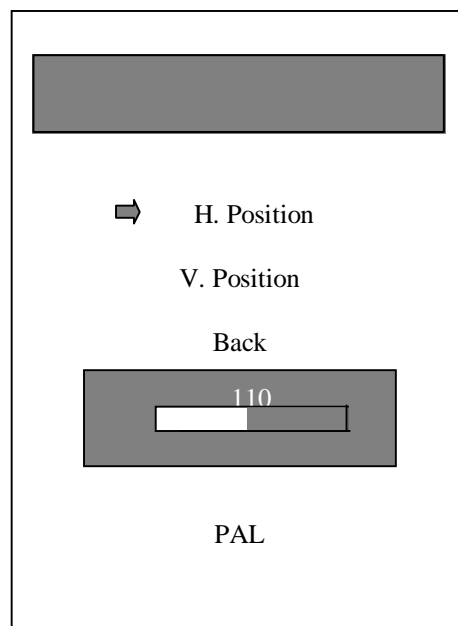

**Position** This option allows the horizontal and vertical centering of the screen display. Press Menu after selection. Press Up or Down to change value. Press Back to return to Main Menu followed by Exit.

### Main Menu

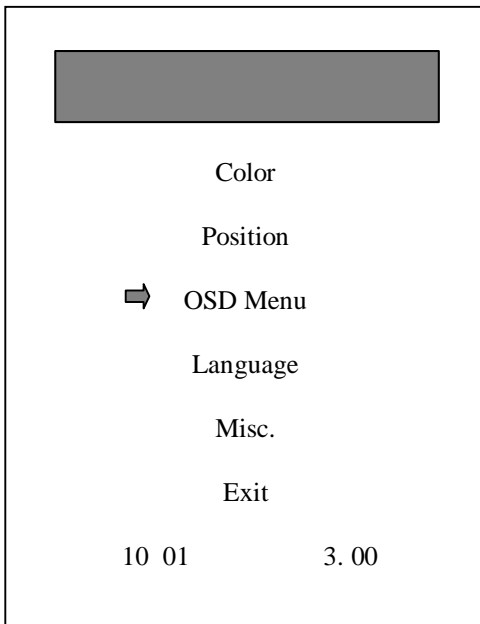

### OSD Menu

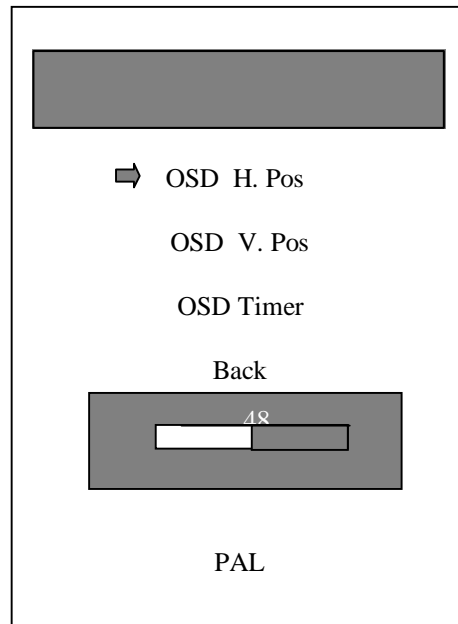

**OSD Position** This option allows the OSD menu to be centered.  
Press Menu after selection. Press Up or Down to change value.  
Press Back to return to Main Menu followed by Exit.

### Main Menu

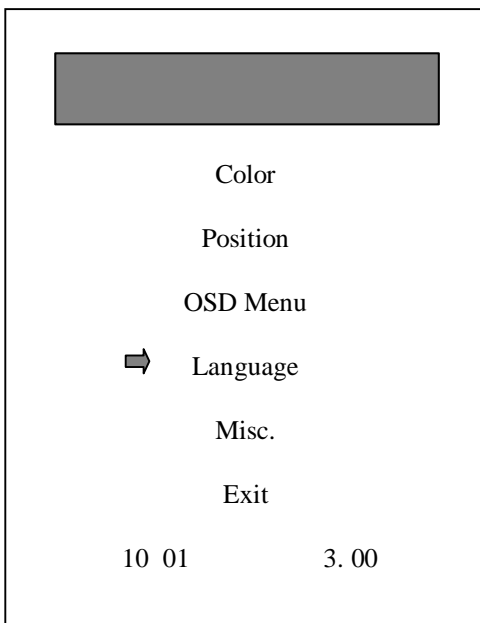

### Language

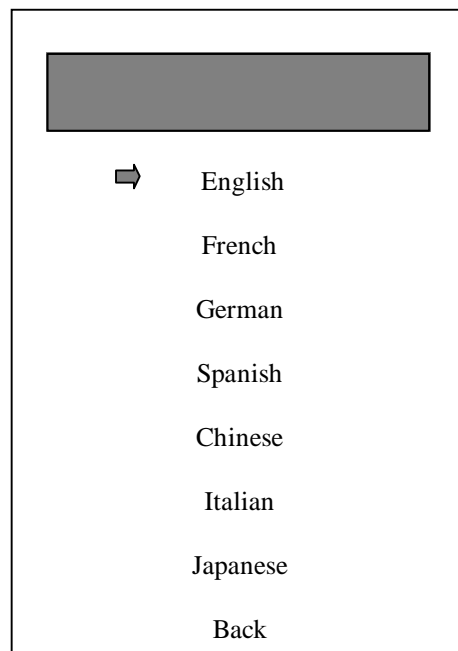

**Language** This option allows the language to be selected.  
Press Menu after selection. Press Up or Down to change language.  
Press Back to return to Main Menu followed by Exit.

**Main Menu**

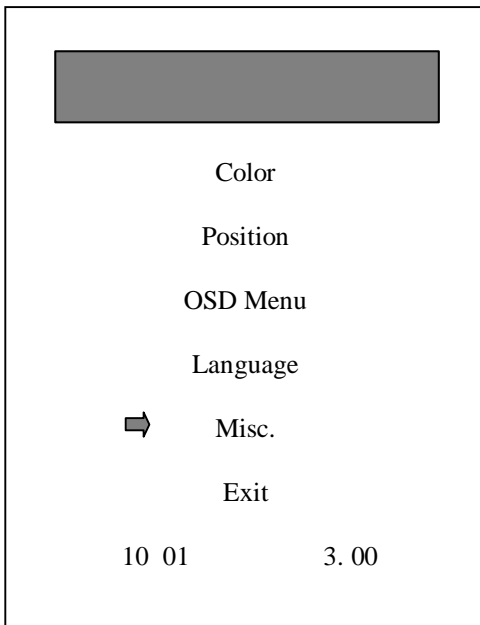

**Misc. Menu**

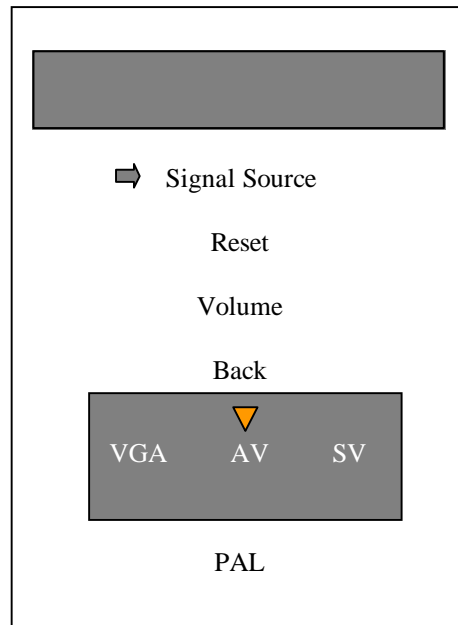

Misc. Signal Source

This option allows the signal source to be selected. Select from VGA, AV or SV. Press Menu after selection.

Reset

This resets manufacturers settings.

Volume

This sets speaker volume.

Press Back to return to Main Menu followed by Exit.

**Technical Details**

Function	Specification
Video Composite	1 x video composite and 1 x video composite out (loopthrough)
Display Resolution (Panel)	640 x 480
Aspect Ratio	4:3
Brightness (Central)	350 cd/m <sup>2</sup>
Contrast Ratio	300 : 1
Response Time	60ms
Input Voltage	12vDC 4A PSU supplied
VGA Input	15pin D-SUB connector x 1
S-Video	1 x S-Video In and 1 x S-Video Out
Audio Input	1 x 3.5mm Stereo jack
Speaker	2 built-in speakers
Bracket	Desk Bracket supplied
Power Consumption	17.2W
Weight	1.8kg
Dimensions	W261 x H223 x D63mm

All specifications are approximate. Kovert.com reserves the right to change any product specifications or features without notice. Whilst every effort is made to ensure that these instructions are complete and accurate, kovert.com cannot be held responsible in any way for any losses, no matter how they arise, from errors or omissions in these instructions, or the performance or non-performance of the equipment that these instructions refer to.



This symbol on the products and/or accompanying documents means that used electronic equipment must not be mixed with general household waste. For treatment, recovery and recycling please return this unit to your trade supplier or local designated collection point as defined by your local council.

WEE/CG0783SS