

ALIEN

Digital Video Recorders

Models

MEGA204 MEGA208 MEGA216
MAX316 MAX416



Version 010

Last Revised 29/2/2016

Preventive and Cautionary Tips

Before connecting and operating your DVR, please note the following:

- Ensure unit is installed in a well-ventilated, dust-free environment.
- Unit is designed for indoor use only.
- Keep all liquids away from the DVR.
- Ensure environmental conditions meet factory specifications.
- Use the DVR in conjunction with an UPS if possible.
- Power down the unit before connecting and disconnecting accessories and peripherals.



WEE/CG0783SS

This symbol on the products and/or accompanying documents means that used electronic equipment must not be mixed with general household waste. For treatment, recovery and recycling please return this unit to your trade supplier or local designated connection point as defined by your local council.

Product Key Features

General

- Connects to HD-TVI and analogue cameras;
- Connects to IP cameras;
- Each channel supports dual-stream. Main stream supports up to 1080P resolution and sub-stream supports up to WD1 resolution;
- Independent configuration for each channel, including resolution, frame rate, bit rate, image quality, etc.
- Encoding for both video stream and video & audio stream; audio and video synchronisation during composite stream encoding;
- Watermark technology;

Local Monitoring

- HDMI(1)/VGA output at up to 1920*1080 resolution;
- 1/4/6/8/9/16/25/36 screen live view is supported, and the display sequence of screens is adjustable;
- Live view screen can be switched in group and manual mode, with automatic sequencing for live view mode also provided, allowing adjustment of interval time;
- Quick setting menu is provided for live view;
- The selected live view channel can be covered;
- Motion detection, video-tampering detection, video exception alarm, video loss alarm functions;
- Privacy mask;
- Several PTZ protocols supported; PTZ presets, patrol and pattern;
- Zooming in/out by clicking the mouse and PTZ movement dragging mouse;

HDD Management

- For MEGA204,MEGA208, MEGA216 only 1 SATA hard disk can be connected;
For MAX316, 4x SATA hard disks without DVD writer but 2 with and 1 eSATA disk can be connected;
For MAX416, 8x SATA hard disks without DVD writer but 4 with and 1 eSATA disk can be connected.
(Each hard drive disk with a maximum of 6TB storage capacity.)
- 8 network disks (8 x NAS disks, or 7x NAS disks +1 IP SAN disk) can be connected;
- Support eSATA disks for recording or backup;
- Support S.M.A.R.T. and bad sector detection;
- Support HDD sleeping function;
- HDD property: redundancy, read-only, read/write (R/W);
- HDD group management;

- HDD quota management; different capacity can be assigned to different channels;

Recording and Playback

- Holiday recording schedule configuration;
- Cycle and non-cycle recording modes;
- Normal and event video encoding parameters;
- Multiple recording types: manual, continuous, alarm, motion, motion or alarm, motion & alarm and VCA;
- 8 recording time periods with separated recording types;
- Pre-record and post-record for motion detection triggered recording, and pre-record time for schedule and manual recording;
- Searching record files by events (alarm input/motion detection);
- Customisation of tags, searching and playing back by tags;
- Locking and unlocking of record files;
- Local redundant recording;
- Searching and playing back record files by camera number, recording type, start time, end time, etc.;
- Instant Detective playback to go through less effective information;
- Zooming in for any area when playback;
- Reverse playback of multi-channel;
- Supports pause, fast forward, slow forward, skip forward, and skip backward when playback, locating by dragging the mouse on the progress bar;
- 4/8/16/24 channel synchronous playback at 1080P.

Backup

- Export data by a USB, SATA or eSATA device;
- Export video clips when playback;
- Management and maintenance of backup devices.

Alarm and Exception

- Configurable arming time of alarm input/output;
- Alarm for video loss, motion detection, video tampering, abnormal signal, video input/recording resolution mismatch, illegal login, network disconnected, IP conflict, record exception, HDD error, and HDD full, etc.;
- Alarm triggers full screen monitoring, audio alarm, notifying surveillance center, sending email and alarm output;
- VCA (Video Content Analysis) detection alarm (line crossing detection and intrusion detection) is supported;
- Automatic restore when system is abnormal.

Other Local Functions

- Manual and automatic video quality diagnostics;

- Users can operate by mouse and remote control;
- Three-level user management; admin user can create many operating accounts and define their operating permissions which include the permissions to access any channel;
- Completeness of operation, alarm, exceptions and log writing and searching;
- Manually triggering and clearing alarms;
- Importing and exporting of configuration files;
- Getting cameras type information automatically.

Network Functions

- 1 network adaptor for 10M/100M network interface for MEGA204 and MEGA208, 1 network adaptor for 10M/100M/1000M network interface for MEGA216 and MAX316, 2 network adaptors for 10M/100M/1000M network interfaces for MAX416 with three working modes : multi-address, load balance and network fault tolerance;
- IPv6 is supported;
- TCP/IP protocol, PPPoE, DHCP, DNS, DDNS, NTP, SMTP, UPnP™ and HTTPS are supported;
- TCP, UDP and RTP for unicast;
- Auto/Manual port mapping by UPnP™
- Remote search, playback, download, locking and unlocking the record files, and downloading files broken transfer resume;
- Remote parameters setup; remote import/export of device parameters;
- Remote viewing of the device status, system logs and alarm status;
- Remote keyboard operation;
- Remote locking and unlocking of control panel and mouse;
- Remote HDD formatting and program upgrading;
- Remote system restart and shutdown;
- Support upgrading via remote FTP server;
- RS-232, RS-485 transparent channel transmission;
- Alarm and exception information can be sent to the remote host;
- Remotely start/stop recording;
- Remotely start/stop alarm output;
- Remote PTZ control;
- Remote JPEG capture;
- Two-way audio and voice broadcasting;
- Embedded WEB server.

Table of Contents

Preventative and Cautionary Tips.....	2
Product Key Features.....	3
Table of Contents	6
Chapter 1 Introduction	10
1.1 Front Panels	10
1.1.1 Front Panel of MEGA204.....	10
1.1.2 Front Panel of MEGA208.....	12
1.1.3 Front Panel of MEGA216.....	14
1.1.4 Front Panel of MAX316.....	16
1.1.5 Front Panel of MAX416.....	19
1.2 IR Remote Control Operations.....	22
1.3 USB Mouse Operation.....	24
1.4 Input Method Description	25
1.5 Rear Panel.....	26
1.5.1 MEGA204/MEGA208/MEGA216.....	26
1.5.2 MAX316.....	27
1.5.3 MAX416.....	28
Chapter 2 Getting Started.....	29
2.1 Starting Up and Shutting Down the DVR	29
2.2 Using the Wizard for Basic Configuration	31
2.3 Adding and Connecting the IP Cameras.....	35
2.3.1 Adding the Online IP Cameras	35
2.3.2 Editing the Connected IP Cameras and Configuring Customised Protocols	38
Chapter 3 Live View.....	40
3.1 Introduction to Live View	40
3.2 Operations in Live View Mode.....	40
3.2.1 Front Panel Operation	41
3.2.2 Using the Mouse in Live View	41
3.2.3 Main/Aux Output Switching.....	42
3.2.4 Quick Setting Toolbar in Live View Mode.....	43
3.3 Channel-zero Encoding.....	45
3.4 Adjusting Live View Settings.....	46
3.5 Manual Video Quality Diagnostics	48
3.6 User Logout	49
Chapter 4 PTZ Controls.....	50
4.1 Configuring PTZ Settings	50
4.2 Setting PTZ Presets, Patrols & Patterns	51
4.2.1 Customising Presets.....	51
4.2.2 Calling Presets.....	52
4.2.3 Customising Patrols	52
4.2.4 Calling Patrols.....	53

4.2.5	Customising Patterns	54
4.2.6	Calling Patterns	55
4.2.7	Customising Auto Scans	55
4.2.8	Calling Auto Scans	56
4.2.9	One-touch Park.....	57
4.3	PTZ Control Panel.....	58
Chapter 5	Recording Settings	59
5.1	Configuring Recording Parameters.....	59
5.2	Configuring Record Schedule	62
5.3	Configuring Motion Detection	65
5.4	Configuring Alarm Triggered Record	67
5.5	Configuring VCA (Video Content Analysis) Record	69
5.6	Configuring Manual Record.....	71
5.7	Configuring Holiday Record	72
5.8	Configuring Redundant Recording	74
5.9	Configuring HDD Group for Recording	76
5.10	File Protection.....	77
Chapter 6	Playback.....	79
6.1	Playing Back Recorded Files.....	79
6.1.1	Playing Back by Channel	79
6.1.2	Playing Back by Time.....	81
6.1.3	Playing Back by Event Search.....	82
6.1.4	Playing Back by Tag.....	84
6.1.5	Playing Back by Instant Detective Search	87
6.1.6	Playing Back by System Logs	89
6.1.7	Playing Back External File.....	90
6.2	Auxiliary Functions of Playback	91
6.2.1	Playing Back Frame by Frame.....	91
6.2.2	Digital Zoom	91
6.2.3	Reverse Playback of Multi-channel	92
Chapter 7	Backup	93
7.1	Backing up Record Files.....	93
7.1.1	Backing up by Normal Video Search.....	93
7.1.2	Backing up by Event Search.....	96
7.1.3	Backing up Video Clips	99
7.2	Managing Backup Devices.....	101
Chapter 8	Alarm Settings.....	103
8.1	Setting Motion Detection Triggering	103
8.2	Setting Sensor Alarms.....	105
8.3	Detecting Video Loss.....	107
8.4	Detecting Video Tampering.....	108
8.5	Detecting VCA Alarm.....	110
8.6	Setting All-day Video Quality Diagnostics.....	113
8.7	Handling Exceptions.....	115

8.8	Setting Alarm Response Actions.....	116
8.9	Triggering or Clearing Alarm Output Manually	117
Chapter 9 Network Settings		119
9.1	Configuring General Settings.....	119
9.2	Configuring Advanced Settings.....	121
9.2.1	Configuring DDNS.....	121
9.2.2	Configuring PPPoE Settings.....	123
9.2.3	Configuring NTP Server	124
9.2.4	Configuring SNMP.....	124
9.2.5	Configuring NAT	125
9.2.6	Configuring More Settings	127
9.2.7	Configuring HTTPS Port.....	128
9.2.8	Configuring Email	130
9.3	Checking Network Traffic.....	131
9.4	Configuring Network Detection	132
9.4.1	Testing Network Delay and Packet Loss	132
9.4.2	Exporting Network Packet	133
9.4.3	Checking Network Status.....	133
9.4.4	Checking Network Statistics.....	134
9.5	Networking your DVR	135
Chapter 10 HDD Management		141
10.1	Initialising HDDs	141
10.2	Managing Network HDD.....	142
10.3	Managing eSATA	144
10.4	Managing HDD Group.....	145
10.4.1	Setting HDD Groups.....	145
10.4.2	Setting HDD Property.....	146
10.5	Checking HDD Status.....	148
10.6	Checking S.M.A.R.T Information	149
10.7	Detecting Bad Sector	150
10.8	Configuring HDD Error Alarms	151
10.9	Configuring Privacy Mask.....	151
10.10	Configuring Video Parameters	153
10.11	Configuring OSD Settings.....	154
Chapter 11 DVR Management and Maintenance.....		156
11.1	Viewing System Information.....	156
11.2	Searching and Exporting Log Files.....	156
11.3	Importing/Exporting IP Camera Info	158
11.4	Importing/Exporting Configuration Files.....	159
11.5	Upgrading System.....	160
11.5.1	Upgrading by Local Backup Device	160
11.5.2	Upgrading by FTP	160
11.6	Restoring Default Settings	161

Chapter 12 Others.....162

12.1 Configuring RS-232 Serial Port..... 162

12.2 Configuring General Settings..... 162

12.3 Configuring DST Settings..... 163

12.4 Configuring More Settings..... 164

12.5 Managing User Accounts..... 165

 12.5.1 Adding a User..... 165

 12.5.2 Deleting a User..... 167

 12.5.3 Editing a User..... 168

Chapter 13 Glossary 170

Chapter 14 Troubleshooting 171

Chapter 15 Record Timings 173

15.1 Record Timings for 4 channels - MEGA204 173

15.2 Record Timings for 8 channels - MEGA208 175

15.3 Record Timings for 16 channels -MEGA216/MAX316/MAX416 177

_Toc402517568

Chapter 1 Introduction

1.1 Front Panels

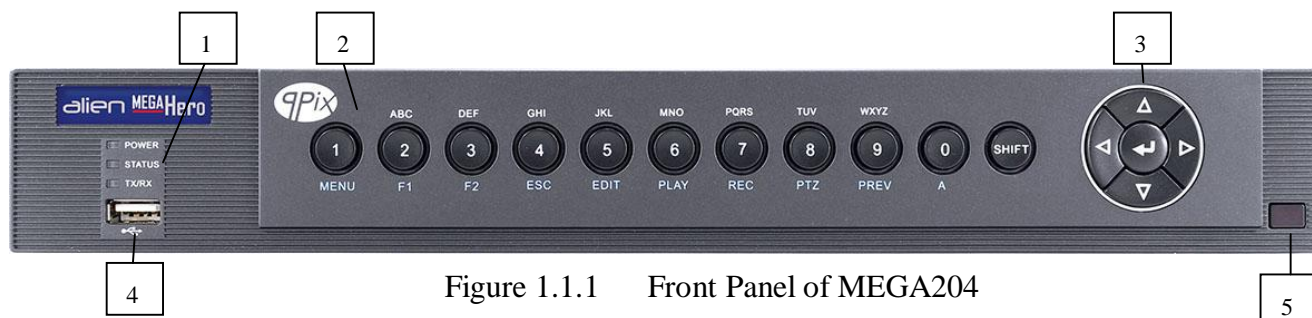

Figure 1.1.1 Front Panel of MEGA204

No.	Name	Function Description	
1	POWER	Power indicator turns yellow when the device s running.	
	STATUS	Status indicator blinks red when data is being read from or written to HDD, and turns yellow when the SHIFT function is pressed.	
	Tx/Rx	Tx/Rx indicator blinks yellow when network connection is functioning properly.	
2	Composite Keys	SHIFT	Switch between the numeric or letter input and functions of the composite keys.
		1/MENU	Enter numeral “1”; Access the main menu interface.
		2/ABC/F1	Enter numeral “2”;
			Enter letters “ABC”;
			The F1 button when used in a list field will select all items in the list.
		3/DEF/F2	In PTZ Control mode, it will turn on/off PTZ light and when the image is zoomed in, the key is used to zoom out.
			In live view or playback mode, the F1 button can be used to switch between main and spot video output.
			Enter numeral “3”;
		4/GHI/ESC	Enter letters “DEF”;
			The F2 button is used to change the tab pages.
			In PTZ control mode, it zooms in the image.
		5/JKL/EDIT	Enter numeral “4”;
Enter letters “GHI”;			
Exit and back to the previous menu.			
6/MNO/PLAY	Enter numeral “5”;		
	Enter letters “JKL”;		
	Delete characters before cursor;		
6/MNO/PLAY	Check the checkbox and select the ON/OFF switch;		
	Start/stop record clipping in playback.		

No.	Name	Function Description
		Enter letters “MNO”;
		In Playback mode, it is used for direct access to playback interface.
	7/PQRS/REC	Enter numeral “7”;
		Enter letters “PQRS”;
		Manual record, for direct access to manual record interface; manually enable/disable record.
	8/TUV/PTZ	Enter numeral “8”;
		Enter letters “TUV”;
		Access PTZ control interface.
	9/WXYZ/PREV	Enter numeral “9”;
		Enter letters “WXYZ”;
		Multi-channel display in live view.
	0/A	Enter numeral “0”;
		Shift the input methods in the editing text field. (Upper and lowercase, alphabet, symbols or numeric input).
	3	DIRECTION
In the Playback mode, the Up and Down button is used to speed up and slow down recorded video. The Left and Right button will select the next and previous record files.		
In Live View mode, these buttons can be used to cycle through channels.		
In PTZ control mode, it can control the movement of the PTZ camera.		
ENTER		The ENTER button is used to confirm selection in any of the menu modes.
		It can also be used to <i>tick</i> checkbox fields.
		In Playback mode, it can be used to play or pause the video.
		In single-frame Playback mode, pressing the button will advance the video by a single frame.
		In Auto-switch mode, it can be used to stop /start auto switch.
4	USB Interface	Universal Serial Bus (USB) ports for additional devices such as USB mouse and USB Hard Disk Drive (HDD).
5	IR Receiver	Receiver for IR remote control.

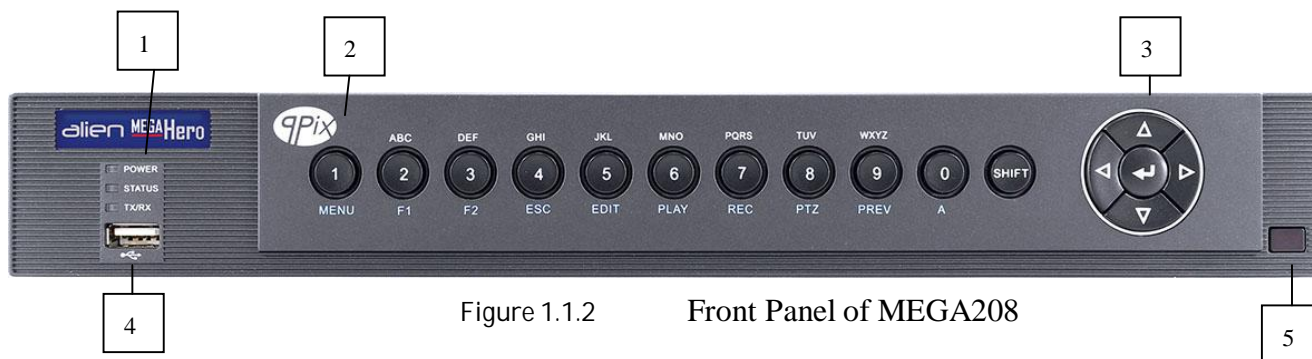

Figure 1.1.2 Front Panel of MEGA208

No.	Name	Function Description	
1	POWER	Power indicator turns yellow when the device is running.	
	STATUS	Status indicator blinks red when data is being read from or written to HDD, and turns yellow when the SHIFT function is pressed.	
	Tx/Rx	Tx/Rx indicator blinks yellow when network connection is functioning properly.	
2	Composite Keys	SHIFT	Switch between the numeric or letter input and functions of the composite keys.
		1/MENU	Enter numeral "1"; Access the main menu interface.
		2/ABC/F1	Enter numeral "2";
			Enter letters "ABC";
			The F1 button when used in a list field will select all items in the list. In PTZ Control mode, it will turn on/off PTZ light and when the image is zoomed in, the key is used to zoom out. In live view or playback mode, the F1 button can be used to switch between main and spot video output.
		3/DEF/F2	Enter numeral "3";
			Enter letters "DEF";
			The F2 button is used to change the tab pages. In PTZ control mode, it zooms in the image.
		4/GHI/ESC	Enter numeral "4";
			Enter letters "GHI";
			Exit and back to the previous menu.
		5/JKL/EDIT	Enter numeral "5";
Enter letters "JKL";			
Delete characters before cursor;			

		Start/stop record clipping in playback.
	6/MNO/PLAY	Enter numeral “6”;
		Enter letters “MNO”;
		In Playback mode, it is used for direct access to playback interface.
	7/PQRS/REC	Enter numeral “7”;
		Enter letters “PQRS”;
		Manual record, for direct access to manual record interface; manually enable/disable record.
	8/TUV/PTZ	Enter numeral “8”;
		Enter letters “TUV”;
		Access PTZ control interface.
	9/WXYZ/PREV	Enter numeral “9”;
		Enter letters “WXYZ”;
		Multi-channel display in live view.
	0/A	Enter numeral “0”;
Shift the input methods in the editing text field. (Upper and lowercase, alphabet, symbols or numeric input).		
3	DIRECTION	The DIRECTION buttons are used to navigate between different fields and items in menus.
		In the Playback mode, the Up and Down button is used to speed up and slow down recorded video. The Left and Right button will select the next and previous record files.
		In Live View mode, these buttons can be used to cycle through channels.
		In PTZ control mode, it can control the movement of the PTZ camera.
	ENTER	The ENTER button is used to confirm selection in any of the menu modes.
		It can also be used to <i>tick</i> checkbox fields.
		In Playback mode, it can be used to play or pause the video.
		In single-frame Playback mode, pressing the button will advance the video by a single frame.
		In Auto-switch mode, it can be used to stop /start auto switch.
4	USB Interface	Universal Serial Bus (USB) ports for additional devices such as USB mouse and USB Hard Disk Drive (HDD).
5	IR Receiver	Receiver for IR remote control.

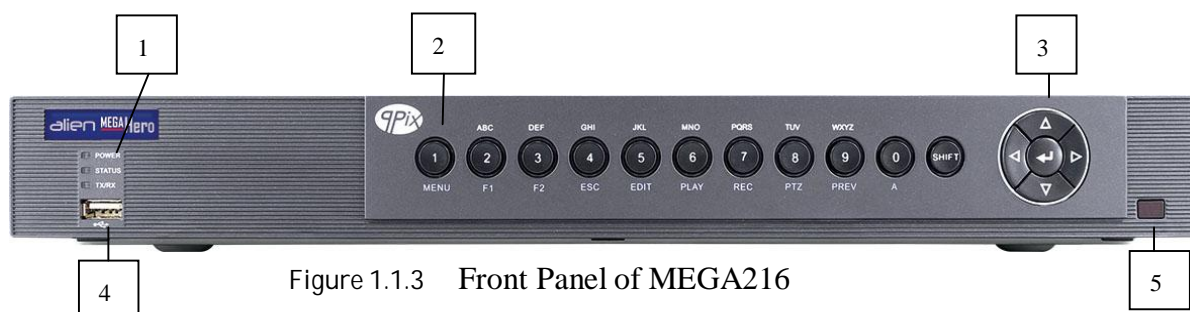

Figure 1.1.3 Front Panel of MEGA216

No.	Name	Function Description	
1	POWER	Power indicator turns yellow when the device s running.	
	STATUS	Status indicator blinks red when data is being read from or written to HDD, and turns yellow when the SHIFT function is pressed.	
	Tx/Rx	Tx/Rx indicator blinks yellow when network connection is functioning properly.	
2	Composite Keys	SHIFT	Switch between the numeric or letter input and functions of the composite keys.
		1/MENU	Enter numeral “1”; Access the main menu interface.
		2/ABC/F1	Enter numeral “2”;
			Enter letters “ABC”;
			The F1 button when used in a list field will select all items in the list. In PTZ Control mode, it will turn on/off PTZ light and when the image is zoomed in, the key is used to zoom out. In live view or playback mode, the F1 button can be used to switch between main and spot video output.
		3/DEF/F2	Enter numeral “3”;
			Enter letters “DEF”;
			The F2 button is used to change the tab pages. In PTZ control mode, it zooms in the image.
		4/GHI/ESC	Enter numeral “4”;
			Enter letters “GHI”;
			Exit and back to the previous menu.
		5/JKL/EDIT	Enter numeral “5”;
Enter letters “JKL”;			
Delete characters before cursor;			

		Start/stop record clipping in playback.
	6/MNO/PLAY	Enter numeral "6";
		Enter letters "MNO";
		In Playback mode, it is used for direct access to playback interface.
	7/PQRS/REC	Enter numeral "7";
		Enter letters "PQRS";
		Manual record, for direct access to manual record interface; manually enable/disable record.
	8/TUV/PTZ	Enter numeral "8";
		Enter letters "TUV";
		Access PTZ control interface.
	9/WXYZ/PREV	Enter numeral "9";
		Enter letters "WXYZ";
		Multi-channel display in live view.
0/A	Enter numeral "0";	
	Shift the input methods in the editing text field. (Upper and lowercase, alphabet, symbols or numeric input).	
3	DIRECTION	The DIRECTION buttons are used to navigate between different fields and items in menus.
		In the Playback mode, the Up and Down button is used to speed up and slow down recorded video. The Left and Right button will select the next and previous record files.
		In Live View mode, these buttons can be used to cycle through channels.
		In PTZ control mode, it can control the movement of the PTZ camera.
	ENTER	The ENTER button is used to confirm selection in any of the menu modes.
		It can also be used to <i>tick</i> checkbox fields.
		In Playback mode, it can be used to play or pause the video.
4	USB Interface	In single-frame Playback mode, pressing the button will advance the video by a single frame.
		In Auto-switch mode, it can be used to stop /start auto switch.
4	USB Interface	Universal Serial Bus (USB) ports for additional devices such as USB mouse and USB Hard Disk Drive (HDD).
5	IR Receiver	Receiver for IR remote control.

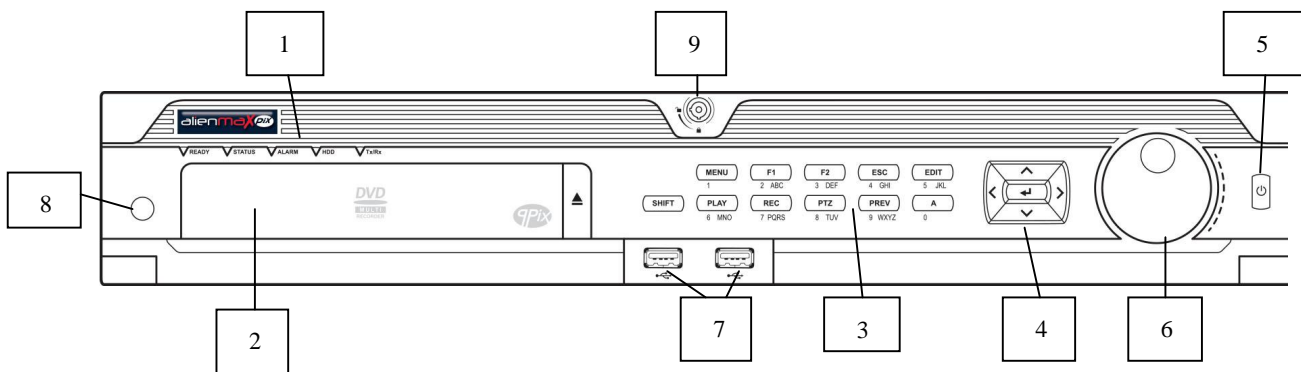

Figure 1.1.4 Front Panel of MAX316

No.	Name	Function Description	
1	READY	Ready indicator is normally green, indicating that the DVR is functioning properly.	
	STATUS	Indicator turns green when DVR is controlled by an IR remote control with the address from 1~254; Indicator turns red when the SHIFT button is used; Indicator does not light when the DVR is controlled by a keyboard or by the IR remote control with the address of 255; Indicator turns green when the DVR is controlled by IR remote control (with the address from 1~254) and keyboard at the same time , and the SHIFT button is not used; Indicator turns orange : (a) when the DVR is controlled by IR remote control (with the address from 1~254) and keyboard at the same time and the SHIFT button is used as well; (b) when the DVR is controlled by IR remote control (with the address from 1~254) and the SHIFT button is used.	
	ALARM	Alarm indicator turns red when a sensor alarm is detected.	
	HDD	HDD indicator blinks in red when data is being read from or written to HDD.	
	Tx/Rx	Tx/Rx indicator blinks in green when network connection is functioning properly.	
2	DVD-R/W	Slot for DVD-R/W.	
3	Composite Keys	SHIFT	Switch between the numeric or letter input and functions of the composite keys. (Input letter or numbers when the light is out; Realize functions when the light is red.)
		1/MENU	Enter numeral “1”; Access the main menu interface.
	2/ABC/F1	Enter numeral “2”;	
		Enter letters “ABC”;	
		The F1 button when used in a list field will select all items in the list. In PTZ Control mode, it will turn on/off PTZ light and when the image is zoomed in, the key is used to zoom out.	
	3/DEF/F2	In live view or playback mode, the F1 button can be used to switch between main and spot video output.	
Enter numeral “3”; Enter letters “DEF”;			

No.	Name	Function Description
		The F2 button is used to change the tab pages.
		In PTZ control mode, it zooms in the image.
	4/GHI/ESC	Enter numeral “4”;
		Enter letters “GHI”;
		Exit and back to the previous menu.
	5/JKL/EDIT	Enter numeral “5”;
		Enter letters “JKL”;
		Delete characters before cursor;
		Check the checkbox and select the ON/OFF switch;
		Start/stop record clipping in playback.
	6/MNO/PLAY	Enter numeral “6”;
		Enter letters “MNO”;
		In Playback mode, it is used for direct access to playback interface.
	7/PQRS/REC	Enter numeral “7”;
		Enter letters “PQRS”;
		Manual record, for direct access to manual record interface; manually enable/disable record.
	8/TUV/PTZ	Enter numeral “8”;
		Enter letters “TUV”;
		Access PTZ control interface.
	9/WXYZ/PREV	Enter numeral “9”;
Enter letters “WXYZ”;		
Multi-channel display in live view.		
0/A	Enter numeral “0”;	
	Shift the input methods in the editing text field. (Upper and lowercase, alphabet, symbols or numeric input).	
4	DIRECTION	The DIRECTION buttons are used to navigate between different fields and items in menus.
		In the Playback mode, the Up and Down button is used to speed up and slow down recorded video. The Left and Right button will select the next and previous record files.
		In Live View mode, these buttons can be used to cycle through channels.
		In PTZ control mode, it can control the movement of the PTZ camera.
	ENTER	The ENTER button is used to confirm selection in any of the menu modes.
		It can also be used to <i>tick</i> checkbox fields.
		In Playback mode, it can be used to play or pause the video.
		In single-frame Playback mode, pressing the button will advance the video by a single frame.
		In Auto-switch mode, it can be used to stop /start auto switch.
5	POWER	Power on/off switch.

No.	Name	Function Description
6	JOG SHUTTLE Control	Move the active selection in a menu. It will move the selection up and down.
		In Live View mode, it can be used to cycle through different channels.
		In the Playback mode, it can be used to jump 30s forward/backward in video files.
		In PTZ control mode, it can control the movement of the PTZ camera.
7	USB Interface	Universal Serial Bus (USB) ports for additional devices such as USB mouse and USB Hard Disk Drive (HDD).
8	IR Receiver	Receiver for IR remote control.
9	Lock	Lock for releasing front panel

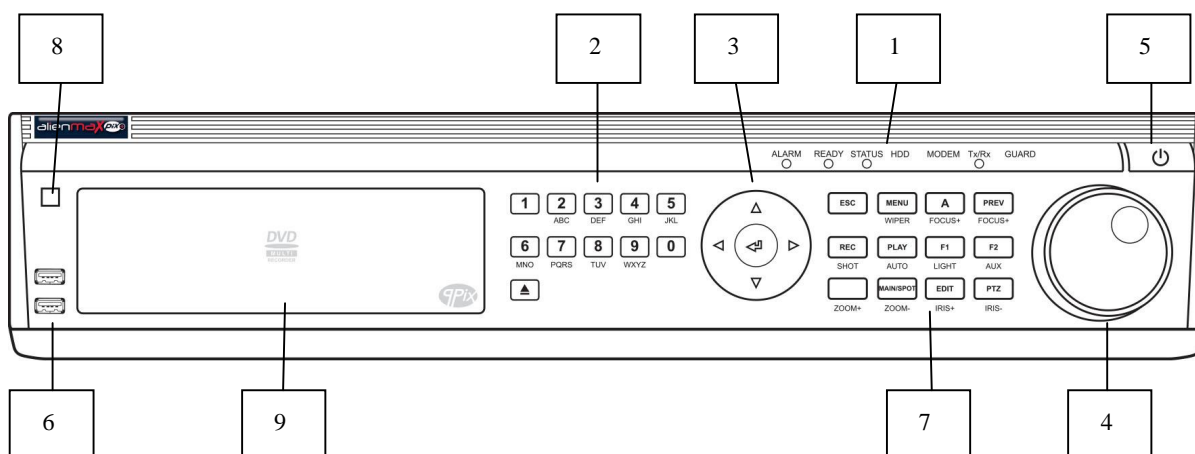

Figure 1.1.5 Front Panel of MAX416

No.	Name	Function Description	
1	Status Indicators	ALARM	Alarm indicator turns red when a sensor alarm is detected.
		READY	Ready indicator is normally blue, indicating that the DVR is functioning properly.
		STATUS	Indicator turns blue when DVR is controlled by an IR remote. Indicator turns red when controlled by a keyboard and orange when IR remote and keyboard is used at the same time. Indicator does not light when the DVR is controlled by the IR remote control with the address of 255.
		HDD	HDD indicator blinks in red when data is being read from or written to HDD.
		MODEM	For future use.
		Tx/Rx	Tx/Rx indicator blinks in blue when network connection is functioning properly.
		GUARD	Indicator turns blue when the device is armed; Indicator does not light when the device is disarmed; The arm/disarm state can be initiated by pressing and holding on the ESC button for more than 3 seconds in live view mode.
2	Alphanumeric Buttons	Switch to the corresponding channel in Live view or PTZ Control mode.	
		Input numbers and characters in Edit mode.	
		Switch between different channels in Playback mode.	
		The light of the button is blue when the corresponding channel is recording; it is red when the channel is in network transmission status; it is pink when the channel is recording and transmitting.	
3	Control Buttons	DIRECTION	The DIRECTION buttons are used to navigate between different fields and items in menus.
			In the Playback mode, the Up and Down button is used to speed up and slow down recorded video. The Left and Right button will select the next and previous record files.
			In Live View mode, these buttons can be used to cycle through channels.
			In PTZ control mode, it can control the movement of the PTZ camera.

No.	Name		Function Description
		ENTER	The ENTER button is used to confirm selection in any of the menu modes.
			It can also be used to <i>tick</i> checkbox fields.
			In Playback mode, it can be used to play or pause the video.
			In single-frame Playback mode, pressing the button will advance the video by a single frame.
			In Auto-switch mode, it can be used to stop /start auto switch.
4	JOG SHUTTLE Control		Move the active selection in a menu. It will move the selection up and down.
			In Live View mode, it can be used to cycle through different channels.
			In the Playback mode: the outer ring is used to speed up or slow down the record files and the inner ring is used to jump 30s forward/backward in records files.
			In PTZ control mode, it can control the movement of the PTZ camera.
5	POWER		Power on/off switch.
6	USB Interfaces		Universal Serial Bus (USB) ports for additional devices such as USB mouse and USB Hard Disk Drive (HDD).
7	Composite Keys	ESC	Exit and back to the previous menu.
			Arm/disarm the DVR in live view mode.
		REC/SHOT	Enter the Manual Record setting menu.
			In PTZ control settings, press the button and then you can call a PTZ preset by pressing Numeric button.
			It is also used to turn audio on/off in the Playback mode.
		PLAY/AUTO	Enter the Playback menu;
			Auto scan in the PTZ Control mode.
		ZOOM+	Zoom in the PTZ camera in the PTZ Control setting.
		A/FOCUS+	Adjust focus in the PTZ Control menu.
			It is also used to switch between input methods (upper and lowercase alphabet, symbols and numeric input).
		EDIT/IRIS+	Edit text fields. When editing text fields, it will also function as a Backspace button to delete the character in front of the cursor.
			On checkbox fields, pressing the button will <i>tick</i> the checkbox.
			In PTZ Control mode, the button adjusts the iris of the camera.
			In Playback mode, it can be used to generate video clips for backup.
			Enter/exit the folder of USB device and eSATA HDD.
		MAIN/SPOT/ ZOOM-	Switch between main and spot output.
			In PTZ Control mode, it can be used to zoom out the image.
		F1/ LIGHT	Select all items on the list when used in a list field.
			In PTZ Control mode, it will turn on/off PTZ light (if applicable).
In Playback mode, it is used to switch between play and reverse play.			
F2/ AUX	Cycle through tab pages.		
	In synchronous playback mode, it is used to switch between channels.		

No.	Name	Function Description
	MENU/WIPER	Press the button will help you return to the Main menu (after successful login).
		Press and hold the button for 5 seconds will turn off audible key beep.
		In PTZ Control mode, the MENU/WIPER button will start wiper (if applicable).
		In Playback mode, it is used to show/hide the control interface.
	PREV/FOCUS-	Switch between single screen and multi-screen mode.
		In PTZ Control mode, it is used to adjust the focus in conjunction with the A/FOCUS+ button.
	PTZ/IRIS-	Enter the PTZ Control mode.
In the PTZ Control mode, it is used to adjust the iris of the PTZ camera.		
8	IR Receiver	Receiver for IR remote control.
9	DVD-R/W	Slot for DVD-R/W.

1.2 IR Remote Control Operations

The DVR may also be controlled with the included IR remote control. Batteries (2×AAA) must be installed before operation. There are two versions of the IR Remote. The one detailed below is the Advanced IR Remote that can be used to control most functions in the DVR but is only supplied with the Max series of DVR. However the standard MEGA DVR is shipped with a basic IR remote which has limited functionality.



Figure 1.2.1 Remote Control

The keys on the remote control closely resemble the ones found on the front panel.

No.	Name	Description
1	POWER	Power on/off the device.
2	DEV	Enables/Disables Remote Control.
3	Alphanumeric Buttons	Same as Alphanumeric buttons on front panel.
4	EDIT Button	Same as EDIT/IRIS+ button on front panel.
5	A Button	Same as A/FOCUS+ button on front panel.
6	REC Button	Same as REC/SHOT button on front panel.
7	PLAY Button	Same as the PLAY/AUTO button on front panel.
8	INFO Button	Same as the ZOOM+ button on front panel.
9	VOIP/MON Button	Same as the MAIN/SPOT/ZOOM- button on front panel.
10	MENU Button	Same as the MENU/WIPER button on front panel.
11	PREV Button	Same as the PREV/FOCUS- button on front panel.
12	DIRECTION/ENTER Buttons	Same as the DIRECTION/ENTER buttons on front panel.
13	PTZ Button	Same as the PTZ/IRIS- button on front panel.
14	ESC Button	Same as the ESC button on front panel.
15	RESERVED	Reserved for future usage.
16	F1 Button	Same as the F1/LIGHT button on front panel.
17	PTZ Control Buttons	Buttons to adjust the iris, focus and zoom of a PTZ camera.
18	F2 Button	Same as the F2/AUX button on front panel.

Troubleshooting Remote Control:

Make sure you have install batteries properly in the remote control. Aim the remote control at the IR receiver on the front panel. If there is no response after you press any button on the remote, follow the procedure below to troubleshoot.

Steps:

1. Go into Menu > Settings > General > More Settings by operating the front control panel or the mouse.
2. Check and remember DVR ID number. The default ID is 255. Press the DEV button on the remote control.
3. Enter the DVR ID number in step 2.
4. Press the ENTER button on the remote.

If the Status indicator on the front panel turns blue, the remote control is operating properly. If the Status indicator does not turn blue and there is still no response from the remote, please check the following:

1. Batteries are installed correctly and the polarities of the batteries are not reversed.
2. Batteries are fresh and not flat.
3. IR receiver is not obstructed.

If the remote still cannot function properly, please change the remote and try again.

1.3 USB Mouse Operation

A regular 3-button (Left/Right/Scroll-wheel) USB mouse can also be used with this DVR. To use a USB mouse:

Steps:

1. Plug USB mouse into one of the USB interfaces on the front panel of the DVR.
2. The mouse should automatically be detected. If in a rare case the mouse is not detected, the possible reason may be that the two devices are not compatible. In which case try another mouse.

The operation of the mouse:

Name	Action	Description
Left-Click	Single-Click	Live view: Select channel and show the quick set menu. Menu: Select and enter.
	Double-Click	Live view: Switch between single-screen and multi-screen.
	Click and Drag	PTZ control: Wheeling. Privacy mask and motion detection: Select target area. Digital zoom-in: Drag and select target area. Live view: Drag channel/time bar.
Right-Click	Single-Click	Live view: Show menu. Menu: Exit current menu to upper level menu.
Scroll-Wheel	Scrolling up	Live view: Previous screen. Menu: Previous item.
	Scrolling down	Live view: Next screen. Menu: Next item.

1.4 Input Method Description



Figure 1.4.1 Soft Keyboard

Description of the buttons on the soft keyboard:

Icons	Description	Icons	Description
	English		Capital English
	Numbers		Symbols
	Lowercase/Uppercase		Backspace
	Space		Enter
	Exit		

1.5 Rear Panel

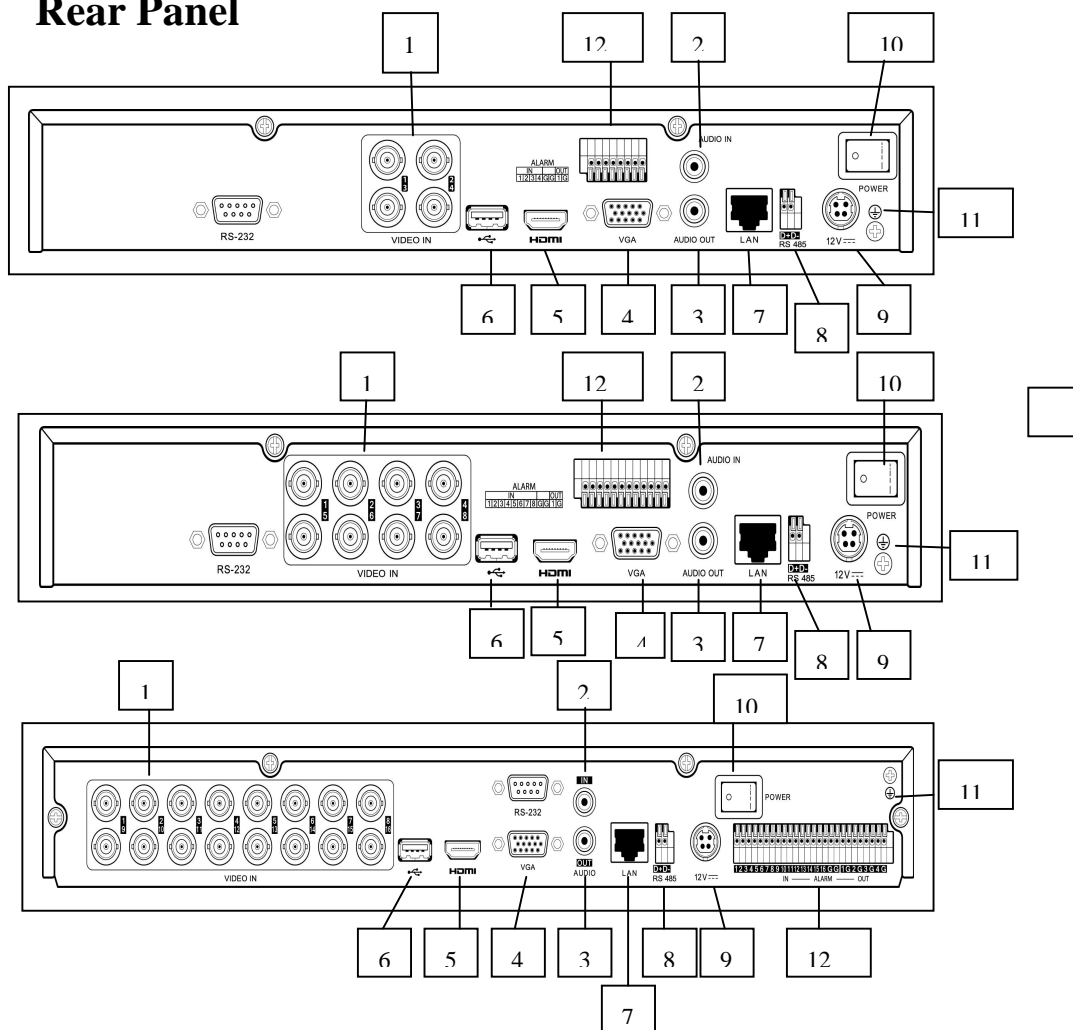

Figure 1.5.1 MEGA204 / MEGA208 / MEGA216

No.	Item	Description
1	VIDEO IN	BNC interface for TVI and analog video input.
2	AUDIO IN	RCA connector
3	AUDIO OUT	RCA connector
4	VGA	DB15 connector for VGA output. Display local video output and menu.
5	HDMI	HDMI video output connector.
6	USB Port	Universal Serial Bus (USB) port for additional devices.
7	Network Interface	Connector for network
8	RS-485 Interface	Connector for RS-485 devices.
9	Power Supply	DC 12V power supply.
10	Power Switch	Switch for turning on/off the device.
11	GND	Ground
12	Alarm In/Out	Connectors for alarm inputs and alarm outputs.

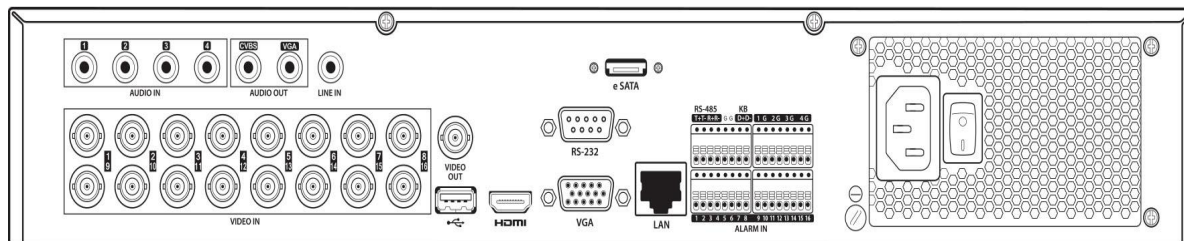

Figure 1.5.2 MAX316

No.	Item	Description
1	VIDEO IN	BNC interface for TVI and analog video input.
2	VIDEO OUT	BNC connector for video output.
3	AUDIO IN	RCA connector
4	USB Port	Universal Serial Bus (USB) port for additional devices.
5	HDMI	HDMI video output connector.
6	VGA	DB15 connector for VGA output. Display local video output and menu.
7	AUDIO OUT	RCA connector.
8	Network Interface	Connector for network
9	RS-485 Interface	Connector for RS-485 devices. T+ and T- pins connect to R+ and R- pins of PTZ receiver respectively.
		D+, D- pin connects to Ta, Tb pin of controller. For cascading devices, the first DVR's D+, D- pin should be connected with the D+, D- pin of the next DVR.
		Connector for alarm input.
		Connector for alarm output.
10	Power Supply	100 ~ 240V AC power supply.
11	Power Switch	Switch for turning on/off the device.
12	GND	Ground
13	LINE IN	BNC connector for audio input.
14	eSATA	Connects external SATA HDD, CD/DVD-RW.
15	RS-232 Interface	Connector for RS-232 devices.

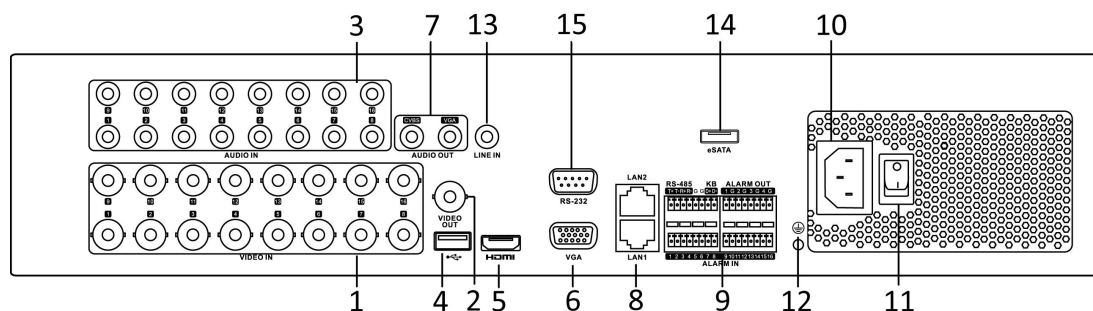

Figure 1.5.3 MAX416

No.	Item	Description
1	VIDEO IN	BNC interface for TVI and analog video input.
2	VIDEO OUT	BNC connector for video output.
3	AUDIO IN	RCA connector
4	USB Port	Universal Serial Bus (USB) port for additional devices.
5	HDMI	HDMI video output connector.
6	VGA	DB15 connector for VGA output. Display local video output and menu.
7	AUDIO OUT	RCA connector.
8	Network Interface	Connector for network
9	RS-485 Interface	Connector for RS-485 devices. T+ and T- pins connect to R+ and R- pins of PTZ receiver respectively. D+, D- pin connects to Ta, Tb pin of controller. For cascading devices, the first DVR's D+, D- pin should be connected with the D+, D- pin of the next DVR.
		Connector for alarm input.
		Connector for alarm output.
10	Power Supply	100 ~ 240V AC power supply.
11	Power Switch	Switch for turning on/off the device.
12	GND	Ground
13	LINE IN	BNC connector for audio input.
14	eSATA	Connects external SATA HDD, CD/DVD-RW.
15	RS-232 Interface	Connector for RS-232 devices.

Chapter 2 Getting Started

2.1 Starting Up and Shutting Down the DVR

Purpose:

Proper startup and shutdown procedures are crucial for extending the life of the DVR.

Before you start:

If the DVR uses an external power supply check that the voltage matches the DVR's requirement.

Starting the DVR

Steps:

1. Check the power supply is plugged into an electrical outlet. It is **HIGHLY** recommended that an Uninterruptible Power Supply (UPS) be used in conjunction with the device.
2. Turn on the power switch on the rear panel, and the Power indicator LED should turn on indicating that the unit is starting the bootup procedure.
3. After startup, the Power indicator LED remains on.
4. Click the right mouse button and select Menu, or Menu button on the front panel of the DVR if applicable, to enter the Menu Welcome screen.

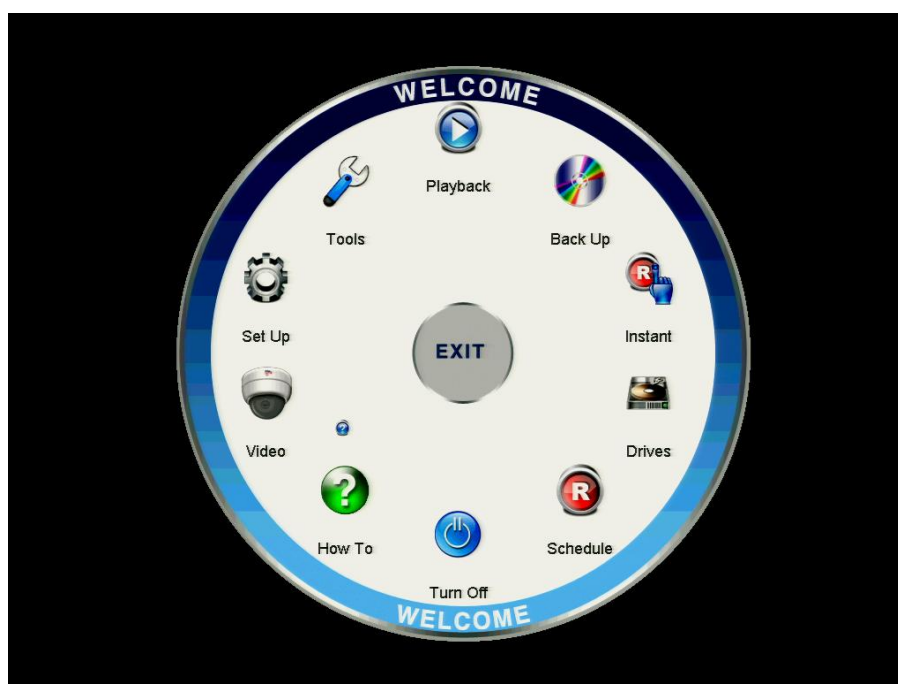

Figure 2.1.1 Menu Welcome Screen

Shutting down the DVR

Steps:

There are two correct ways to shut down the DVR. To shut down the DVR:

- **OPTION 1: Standard shutdown**

1. Enter the Shutdown menu.

Menu > Turn Off

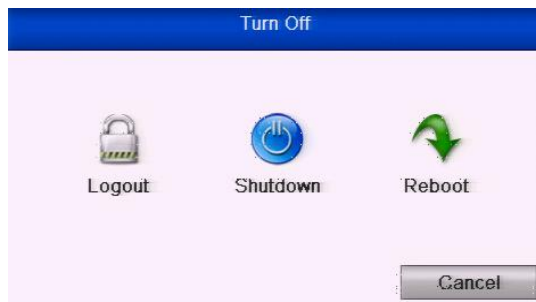

Figure 2.1.2 Shutdown Menu

2. Select the **Shutdown** button.
3. Click the **Yes** button.
4. Turn off the power switch on the rear panel following display below.
(for MEGA200 series).

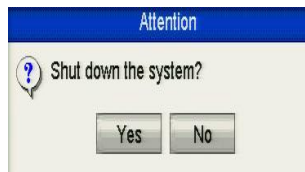

Figure 2.1.3 Shutdown Display

- **OPTION 2: By operating the front panel (for MAX316 and MAX416)**
 1. Press and hold the POWER button on the front panel for 3 seconds.
 2. Enter the administrator's username and password in the dialogue box for authentication.
 3. Click the **Yes** button.

SPECIAL NOTE

- Do not press the POWER button again when the system is shutting down.
- The device remains in standby mode after shutting down, and the POWER indicator turns red; you can turn on the device by pressing the POWER button on the remote control.

Rebooting the DVR

Steps:

1. Enter the **Shutdown** menu by clicking Menu > Shutdown.
2. Click the **Logout** button to log out or the **Reboot** button to reboot the DVR.

2.2 Using the Wizard for Basic Configuration

As the DVRs are setup when the hard drives are installed, using the Setup Wizard is generally not necessary. However if for whatever reason the unit needs to be set for basic operation, then this facility may be useful. You can cancel options not required as you run through the setup.

If initiated the Setup Wizard will start once the DVR has loaded, as shown below.

Steps:

1. Please select the resolution of the monitor in the drop-down list.

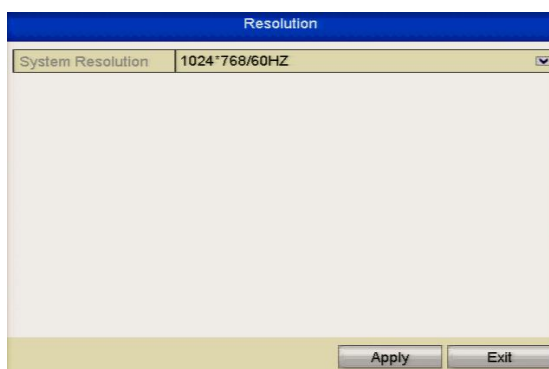

Figure 2.2.1 Resolution Selection

2. The Setup Wizard walks you through some important settings in the DVR. If you do not want to use the Setup Wizard at this time, click the **Cancel** button. You can also choose to use the Setup Wizard next time by leaving the "Start wizard when device starts?" checkbox in checked status.



Figure 2.2.2 Start Wizard Interface

3. Click **Next** button on the Wizard window to enter the **Login** window as shown.

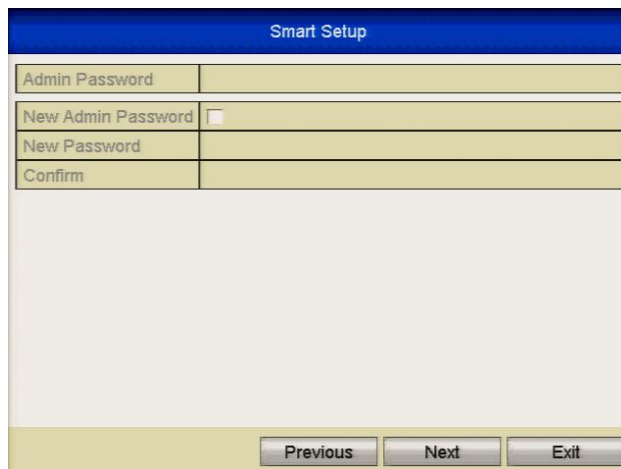

The image shows a 'Smart Setup' window with a blue title bar. It contains a table with four rows for password input:

Admin Password	<input type="text"/>
New Admin Password	<input type="checkbox"/>
New Password	<input type="text"/>
Confirm	<input type="text"/>

At the bottom of the window, there are three buttons: 'Previous', 'Next', and 'Exit'.

Figure 2.2.3 Login Window

4. Enter the admin password. By default, the password is **555555**.

NOTE: It is highly recommended that you change the default password if you are networking the DVR. Failure to do this could allow access to your DVR from malware that may leave the unit unusable.

5. To change the admin password, click the **New Admin Password** checkbox. Enter the new password and confirm the password in the given fields.
6. Click the **Next** button to enter the date and time settings window, as shown below

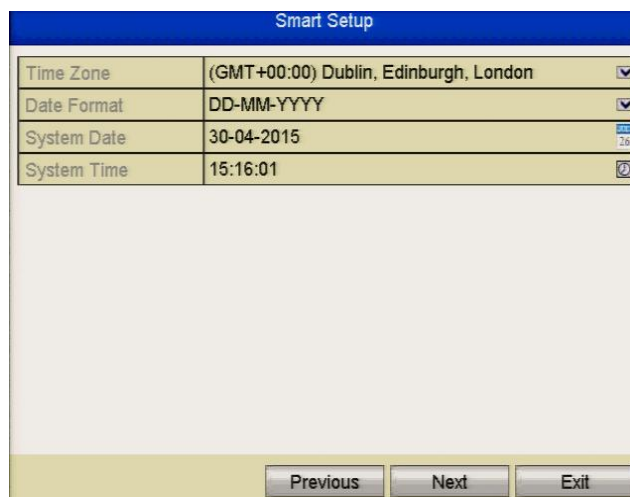

The image shows a 'Smart Setup' window with a blue title bar. It contains a table with four rows for date and time settings:

Time Zone	(GMT+00:00) Dublin, Edinburgh, London	▼
Date Format	DD-MM-YYYY	▼
System Date	30-04-2015	25
System Time	15:16:01	25

At the bottom of the window, there are three buttons: 'Previous', 'Next', and 'Exit'.

Figure 2.2.4 Date and Time Settings

7. After the time settings, click **Next** button which will take you back to the General Network Setup Wizard window, as shown below.

The image shows a 'Smart Setup' window with a blue title bar. It contains a table of network configuration settings. At the bottom, there are three buttons: 'Previous', 'Next', and 'Exit'.

Smart Setup	
NIC Type	10M/100M/1000M Self-adaptive
Enable DHCP	<input type="checkbox"/>
IPv4 Address	192.168.0.241
IPv4 Subnet Mask	255.255.255.0
IPv4 Default Gateway	192.168.0.16
Preferred DNS Serv...	192.168.0.8
Alternate DNS Server	8.8.8.8

Figure 2.2.5 General Network Configuration

1. Self-adaptive 10M/100M network interface for MEGA204 / MEGA208.
2. Self-adaptive 10M/100M/1000M network interface for MEGA216 / MAX316.
3. Self-adaptive 10M/100M/1000M 2 x network interfaces for MAX416 but with three working modes configurable: multi-address, load balance & network fault tolerance options.
4. Click **Next** button after you having configured the network parameters, which will take you to the Advanced Network Setup Wizard window as shown below.

The image shows a 'Wizard' window with a blue title bar. It contains a table of advanced network configuration settings. At the bottom, there are three buttons: 'Previous', 'Next', and 'Exit'.

Wizard	
Server Port	8240
HTTP Port	80
RTSP Port	1240
Enable UPnP	<input type="checkbox"/>
Enable DDNS	<input type="checkbox"/>
DDNS Type	AlienDDNS
Server Address	ippostcode.com
Device Domain Name	ippostcode.com
User Name	
Password	

Figure 2.2.6 Advanced Network Configuration

5. Set the parameters for ports used, Auto UPnP or DDNS if required.
6. Click **Next** button after configuring the advanced network parameters, which will take you to the **HDD Management** window.

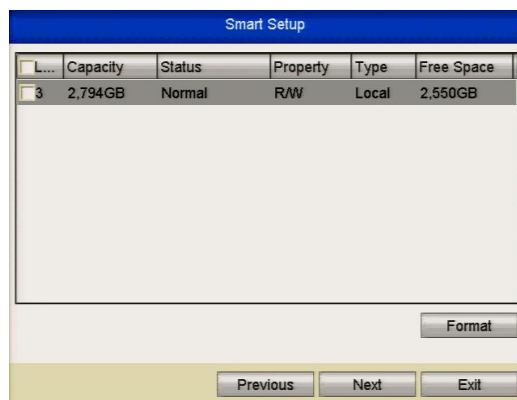

Figure 2.2.7 HDD Management

7. To initialise the HDD, click the **Init** button. Initialisation will remove all the data saved in the HDD.

8. Click **Next** button to enter the IP



Figure 2.2.8 IP Settings

9. Click **Next** button to enter the Record Settings window.

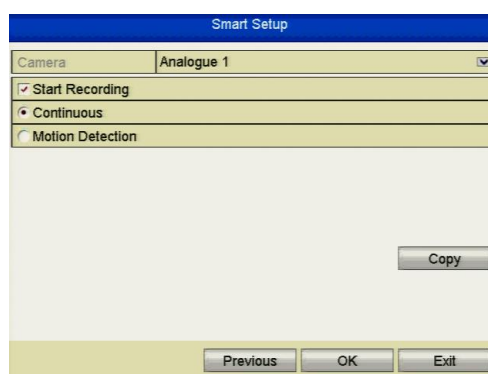

Figure 2.2.9 Record Settings

10. Click **Copy** to copy the recording setting to other cameras.

11. Click **OK** to save the settings and **Exit** Smart Setup.

2.3 Adding and Connecting the IP Cameras

2.3.1 Adding the Online IP Cameras

Purpose:

Before you can get a live view or video recording, you must add the network cameras to the connection list in the DVR.

Before you start:

Ensure the network connection is valid and correct. For detailed checking and configuring of the network, please see Chapter 9 Network Settings

Please refer to the individual DVR specifications for number of connectable network cameras to different models.

• **OPTION 1:**

Steps:

1. Right-click the mouse when you are in the live view mode to show the right-click menu.

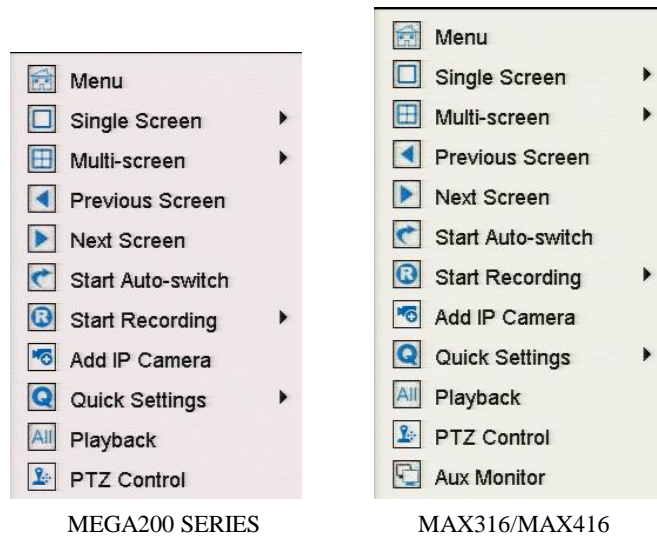

Figure 2.3.1.1 Right-click Menu

2. Select **Add IP Camera** in the pop-up menu to enter the IP Camera Management interface.

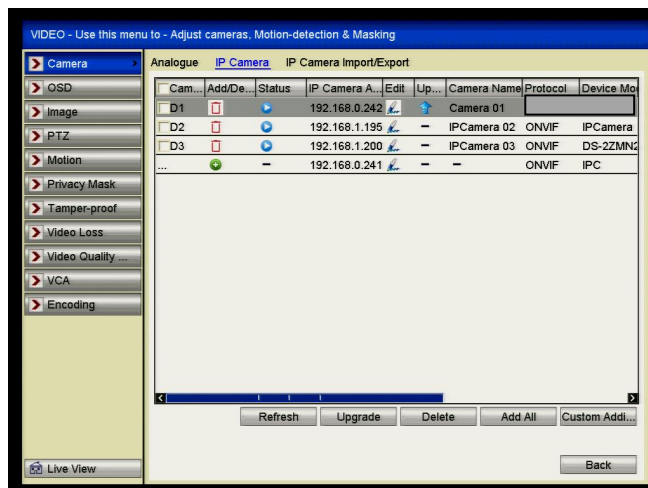









Figure 2.3.1.2 Adding IP Camera Interface

3. The online cameras with same subnet will be displayed in the camera list. Click the  button to add the camera or you can click the **Add All** button to add all the detected online IP cameras.

Icon	Explanation	Icon	Explanation
	Edit basic parameters of the camera		Add the detected IP camera.
	The camera is connected.		The camera is disconnected; you can click the icon to get the exception information of camera.
	Delete the IP camera		Advanced settings of the camera.
	Update the IP camera		

4. To add other IP cameras:
 - 1) Click the **Custom Adding** button to pop up the Add IP Camera (Custom) interface.

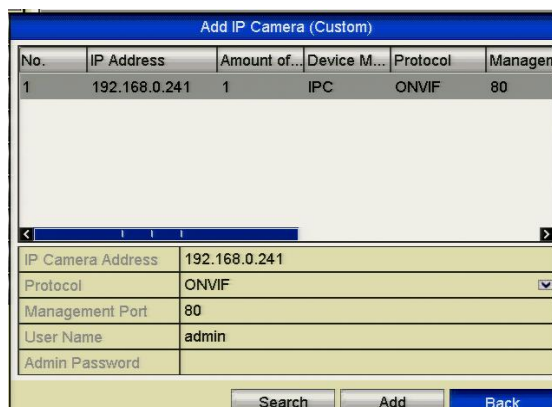

Figure 2.3.1.3 Custom Adding IP Camera Interface

- 2) You can edit the IP address, protocol, port, and other information of the IP camera to be added.
- 3) Click **Add** to add the camera.

• **OPTION 2:**

Steps:

1. Enter the Camera Management interface.
Menu> Video> Camera> IP Camera

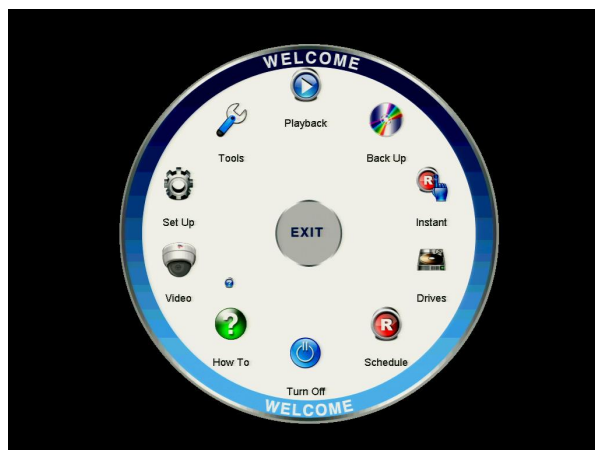









Figure 2.3.1.4 Main Menu

2. Repeat step 3 and 4 in OPTION 1 to add the camera.



Figure 2.3.1.5 IP Camera Management Interface

Icon	Explanation	Icon	Explanation
	Edit basic parameters of the camera		Add the detected IP camera.
	The camera is connected; you can click the icon to get the live view of the camera.		The camera is disconnected; you can click the icon to get the exception information of camera.
	Delete the IP camera		Advanced settings of the camera ,
	Update the IP camera		

3. (For the encoders with multiple channels only) check the checkbox of Channel No. in the display window, as shown in the following figure, and click **OK** to finish adding.

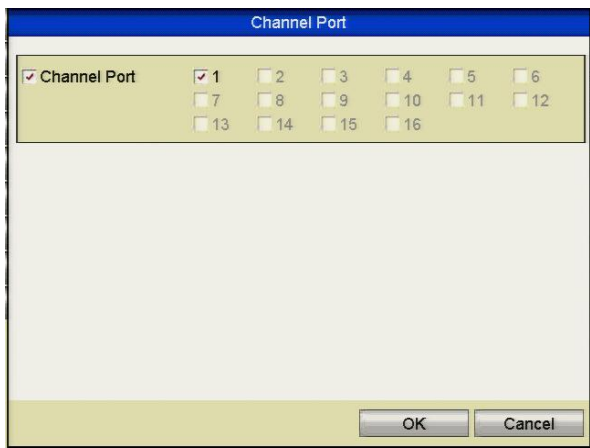



Figure 2.3.1.6 Selecting Multiple Channels

2.3.2 Editing the Connected IP Cameras and Configuring Customised

Protocols

After the adding of the IP cameras, the basic information about the camera can be configured. These are listed on the configuration settings page.

Steps:

1. Click  the icon to edit the parameters; you can edit the IP address, protocol and other parameters.

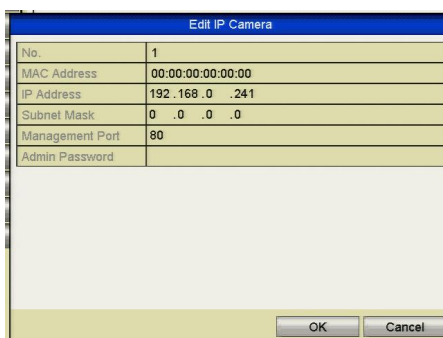



Figure 2.3.2.1 Edit the Parameters

Channel Port: If the connected device is an encoding device with multiple channels, you can choose the channel to connect by selecting the channel port No. in the dropdown list.

2. Click **OK** to save the settings and exit the editing interface.

To edit advanced parameters:

1. Drag the horizontal scroll bar to the right side and click the  icon.

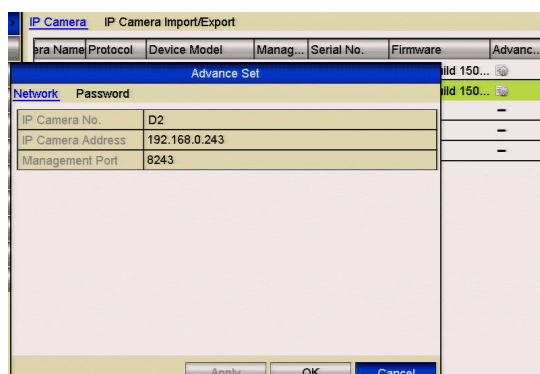

Figure 2.3.2.2 Network Configuration of the Camera

2. You can edit the network information and the password of the camera.

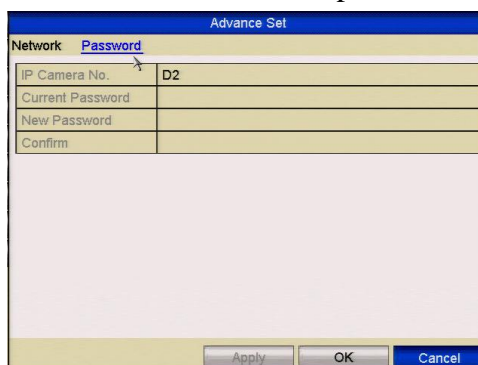

Figure 2.3.2.3 Password Configuration of the Camera

3. Click **Apply** to save the settings and click **OK** to exit the interface.



Chapter 3 Live View

3.1 Introduction to Live View

Live view shows you the video image from each camera in real time. The DVR will automatically enter Live View mode when powered on. It is also at the very top of the menu hierarchy, thus hitting the ESC many times (depending on which menu you're on) will bring you to the Live View mode.

Live View Icons

In the live view mode, there are icons at the right top of the screen for each channel, showing the status of the record and/or alarm of the relevant channel.

Icons	Description
	Alarm (video loss, tampering, motion detection or sensor alarm)
	Record (manual record, schedule record, motion detection or alarm triggered record)
	Alarm & Record

3.2 Operations in Live View Mode

In live view mode, there are many functions provided. The functions are listed below.

- **Single Screen:** show only one channel on the monitor.
- **Multi-screen:** show multiple channels on the monitor simultaneously.
- **Auto-switch:** the screen is auto switched to the next one. You must set the dwell time for each screen in the configuration menu before enabling the auto-switch. Menu>Configuration>Live View>Dwell Time.
- **Start Recording:** normal record and motion detection record are supported.
- **Quick Set:** select the output mode to Standard, Bright, Gentle or Vivid.
- **Playback:** play back the recorded videos for current day.
- **Aux/Main output switch:** the DVR checks the connection of the output interfaces to define the main and auxiliary output interfaces. When the aux output is enabled, the main output is inoperable but you can do some basic operations in live view mode using the Aux output.

The MEGA204,MEGA208 and MEGA216 models do not support Aux/Main output switch.

The priority level for the main and aux output for the MAX316 and MAX416 models for the main and aux output is HDMI/VGA>CVBS.

S.N	VGA/HDMI	CVBS	Main output	Auxiliary output
1	√	√	VGA/HDMI	CVBS
2	√	×	VGA/HDMI	
3	×	√	CVBS	

- √ means the interface is in use, × means the interface is not in use or the connection is invalid. The HDMI, VGA and CVBS can be used at the same time.

3.2.1 Front Panel Operation

This function is not supported by MEGA204, MEGA208 and MEGA216.

Functions	Front Panel Operation
Show single screen	Press the corresponding Alphanumeric button. E.g. Press 2 to display only the screen for channel 2.
Show multi-screen	Press the PREV button.
Manually switch screens	Next screen: right direction button. Previous screen: left direction button.
Auto-switch	Press Enter button.
Playback	Press Play button.

3.2.2 Using the Mouse in Live View

Name	Description
Menu	Enter the main menu of the system by right clicking the mouse.
Single Screen	Switch to the single full screen by choosing channel number from the dropdown list.
Multi-screen	Adjust the screen layout by choosing from the dropdown list.
Previous Screen	Switch to the previous screen.
Next Screen	Switch to the next screen.
Start/Stop Auto-switch	Enable/disable the auto-switch of the screens. <i>The dwell time of the live view configuration must be set before using Start Auto-switch.</i>
Start Recording	Start recording of all channels, Normal Record and Motion Detection Recording are selectable from the dropdown list.
Add IP Camera	A shortcut to enter the IP camera management interface.
Quick Set	Output Mode is configurable with Standard, Bright, Gentle and Vivid options.

Playback	Enter the playback interface and start playing back the video of the selected channel immediately.
PTZ Control	A shortcut to enter the PTZ control interface of the selected camera.
Aux Monitor	Switch to the auxiliary output mode and the operation for the main output is disabled. If you enter Aux monitor mode and the Aux monitor is not connected, the mouse operation is disabled; you need to switch back to the Main output with the F1 button on front panel or VOIP/MON button on IR remote control and then press the Enter button.

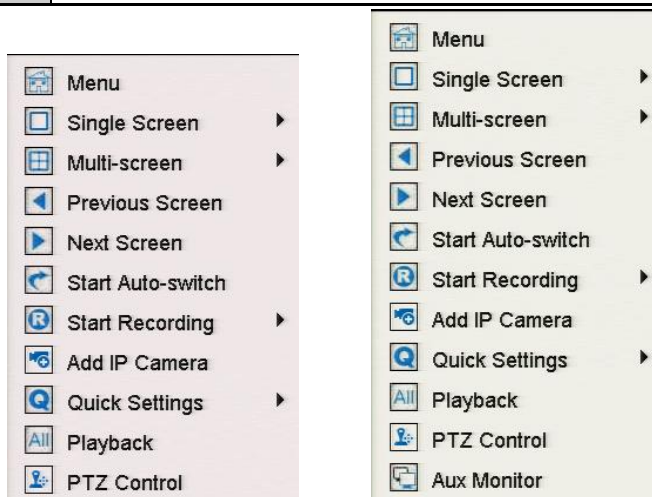

MEGA204/208/216

MAX316 & MAX416

Figure 3.2.1.1 Right-click Menu

3.2.3 Main/Aux Output Switching

The MEGA204, MEGA208 and MEGA216 models do not support Aux/Main output switch.

When the HDMI/VGA output is configured as the main output, you can perform the following operation to switch to CVBS output as the main output.

Steps:

1. Use the mouse wheel to double-click on the HDMI/VGA output screen, and the following message displays:



Figure 3.2.3.1 Switch Main and Aux Output

2. Use the mouse wheel to double-click on the screen again to switch to the Aux

- output, or click **Cancel** to cancel the operation.
- 3. Select the **Menu Output Mode** to **Main CVBS** or **HDMI** from the right-click menu on the monitor.
- 4. On the pop-up message box, click **Yes** to restart the device to enable the CVBS output or HDMI as the main output.

You can select the Menu Output Mode under Menu>Configuration>More Settings to Auto, or HDMI /VGA and then restart the device to switch the main output back to HDMI /VGA output.

3.2.4 Quick Setting Toolbar in Live View Mode

On the screen of each channel, there is a quick setting toolbar which shows when you point the mouse at the bottom of the screen.



Figure 3.2.41 Quick Setting Toolbar

Icons	Description	Icons	Description	Icons	Description
	Enable Manual Record		Instant Playback		Mute Audio
	Image Settings Not HD Models		PTZ Control		Digital Zoom
	Close				

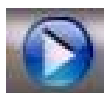

Instant Playback only shows the recording of the last five minutes. If no recording is found, it means there is no recording during the last five minutes.



Digital Zoom can zoom in to the selected area of the full screen. You can left-click and draw to select the area for zooming in, as shown below.

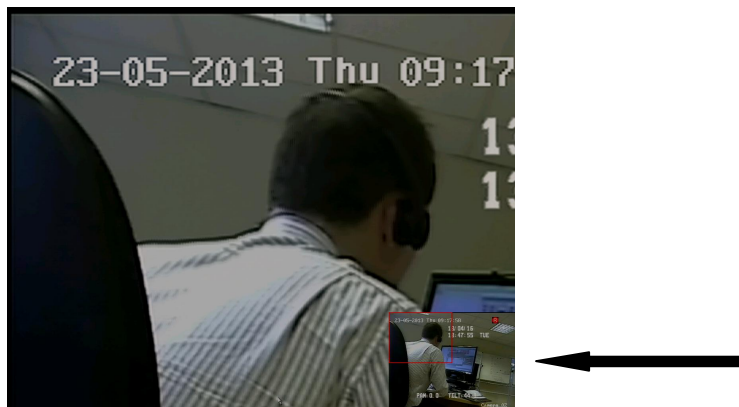

Figure 3.2.4.2 Digital Zoom

 Image Settings icon can be selected to enter the Image Settings menu.

Four modes are selectable according to the real situation:

- **Standard:** for general lighting conditions (default).
- **Indoor:** the image is relatively smoother.
- **Dim Light:** the image is smoother than the other two modes.
- **Outdoor:** the image is relatively clearer and sharper. The degree of contrast and saturation is high.

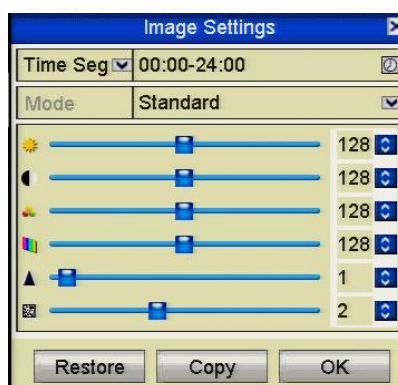

Figure 3.2.4.3 Image Settings

You can adjust the image parameters, including brightness, contrast, saturation, hue, sharpness and denoising. You can also click **Default** to restore the default settings and click **Copy** to copy the image settings to other analogue cameras.

Refer to the *Chapter 10.10 Configuring Video Parameters* for more details.

3.3 Channel-Zero Encoding

This chapter is applicable to MAX316 and MAX416 series only.

Purpose:

Sometimes due to low broadband resources you need to get a remote view of many channels in real time mode from a web browser or client software, in order to decrease the bandwidth requirement without affecting the image quality. The channel-zero encoding facility allows you to display all camera channels on a single channel display and by clicking on one of the imbedded channels, a full channel screen display for that channel is displayed.

Steps:

1. Enter the **Live View** Settings interface.
Menu> Setup> Live View
2. Select the **Channel-Zero Encoding** tab.

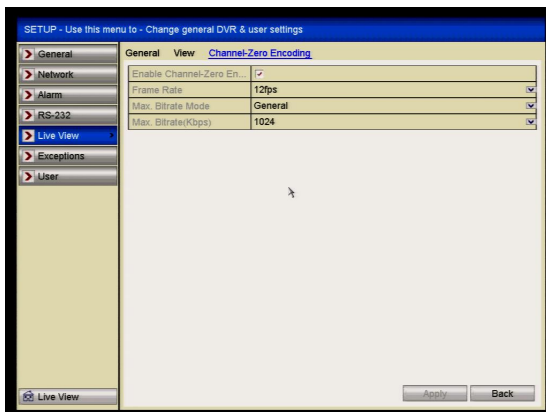

Figure 3.3.1 Live View- Channel-Zero Encoding

3. Click the checkbox after **Enable Channel-Zero Encoding**.
4. Configure the Frame Rate, Max. Bitrate Mode and Max. Bitrate.
5. Click the **Apply** button to activate the settings.

After you set the Channel-Zero encoding, you can get a view in CCTVWindow or web browser, 16 channels on a single channel. When clicking on the imbedded channel, a full screen display of the channel will be shown.

3.4 Adjusting Live View Settings

Purpose:

Live View settings can be customised according to different needs. You can configure the output interface, dwell time for screen to be shown, mute or turning on the audio, the screen number for each channel, etc.

Steps:

1. Enter the Live View Settings interface.

Menu> Setup> Live View

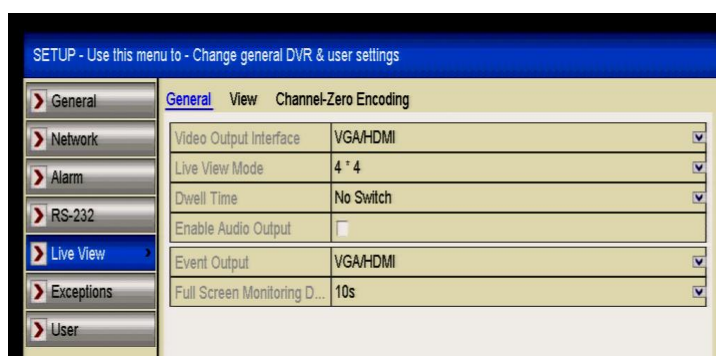

Figure 3.4.1 Live View-General

The settings available in this menu include:

- **Video Output Interface:** Designates the output to configure the settings for. The MEGA204, MEGA208 and MEGA216 provide HDMI/VGA outputs and MAX316 and MAX416 models provide HDMI/VGA and CVBS outputs for selection.
- **Live View Mode:** Designates the display mode to be used for Live View.
- **Dwell Time:** The time in seconds to *dwell* between switching of channels when enabling auto-switch in Live View.
- **Enable Audio Output:** Enables/disables audio output for the selected camera in the live view mode.
- **Event Output:** Designates the output to show event video; if available, you can select a different video output interface in the Video Output Interface when an event occurs.
- **Full Screen Monitoring Dwell Time:** The time in seconds to show alarm event screen.

2. Set the camera order.
 - 1) Select **View** tab.

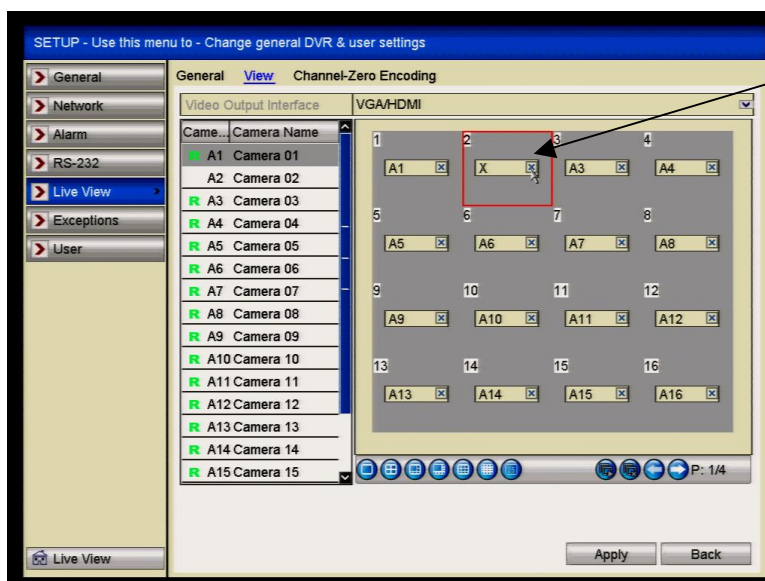





Figure 3.4.2 Live View- Camera Order

- 2) Click a window to select it, and then double-click a camera name in the camera list you would like to display. Setting an 'X' means the window will not display any camera.

- 3) You can also click  to start live view of all channels in order and click  to stop live view of all channels. Click  or  to go to the previous or next page.

- 4) Click the **Apply** button.

3.5 Manual Video Quality Diagnostics

Purpose:

The video quality of the analogue channels can be diagnosed manually and you can view the diagnostic results from a list.

Steps:

1. Enter the Manual Video Quality Diagnostics interface.
Menu> Instant>Manual Video> Manual Video Quality Diagnostics

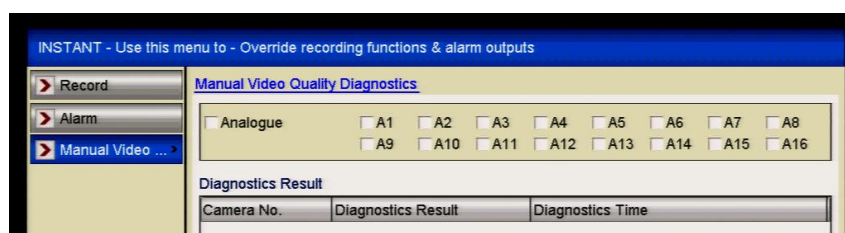

Figure 3.5.1 Video Quality Diagnostics

2. Check the checkboxes to select the channels for diagnostics.
3. Click the button **Diagnose**, and the results will be displayed on a list. You can view the video status and diagnostics time of the selected channels.

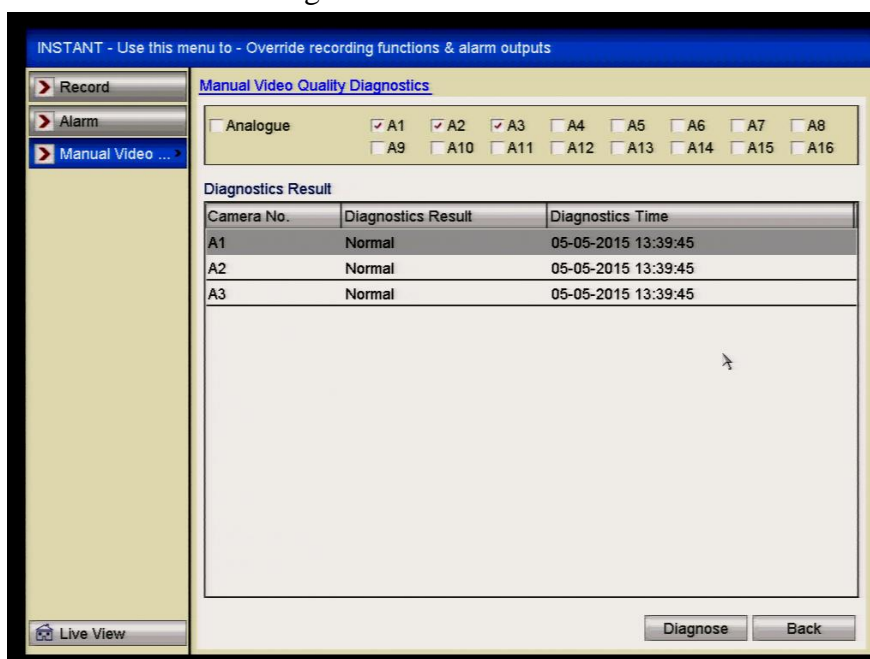

Figure 3.5.2 Diagnostics Result

- Connect the camera to the device for the video quality diagnostics.
- Three exception types can be diagnosed: Blurred Image, Abnormal Brightness and Colour Cast.

3.6 User Logout

Purpose:

After logging out, the monitor returns to the live view mode and if you want to do some operations, you need to enter user name and password to log in again.

Steps:

1. Enter the Shutdown menu.

Menu>Turn Off>Shutdown



Figure 3.6.1 Shutdown

2. Click **Logout**.

Chapter 4 PTZ Controls

4.1 Configuring PTZ Settings

Purpose:

Follow the procedure to set the parameters for PTZ. The configuring of the PTZ parameters must be done for you control the PTZ camera.

Steps:

1. Enter the PTZ Settings interface.
Menu >Video> PTZ



Figure 4.1.1 PTZ Settings

2. Choose the camera for PTZ settings in the **Camera** dropdown list.
3. Click the **PTZ Settings** button to set the RS-485 parameters.

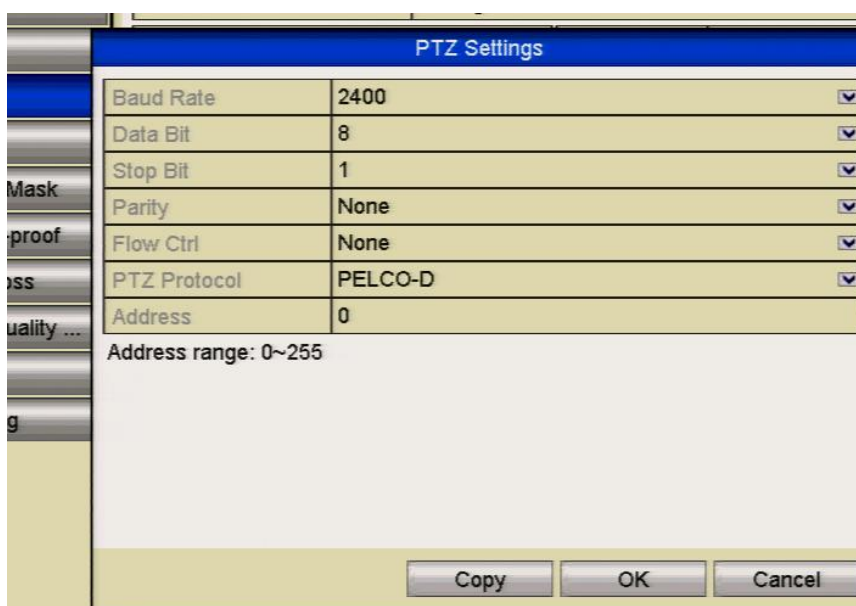

Figure 4.1.3 PTZ- General

4. Enter the parameters of the PTZ camera.
All the parameters should be exactly the same as the PTZ camera parameters.
5. Click **Apply** button to save the settings.

4.2 Setting PTZ Presets, Patrols & Patterns

Before you start:

Please make sure that the presets, patrols or patterns are supported by PTZ equipment used.

4.2.1 Customising Presets

Purpose:

Follow the steps to set the Preset location which you want the PTZ camera to point to when an event takes place.

Steps:

1. Enter the PTZ Control interface.
Menu>Video>PTZ

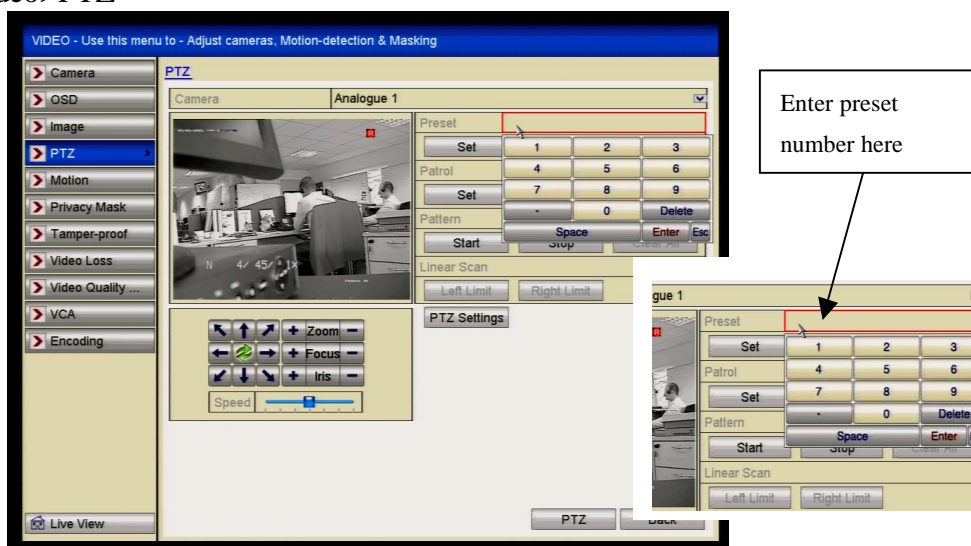

Figure 4.2.1.1. PTZ Settings

2. Use the direction buttons to move the camera to the location where you want to set a preset. Note that the zoom and focus operations can be recorded in the preset as well.
3. Enter the preset No. (1~255) in the preset text field, and click the **Set** button to link the location to the preset.
Repeat the steps 2-3 to save more presets.
You can click the **Clear** button to clear the location information of the preset, or click the **Clear All** button to clear the location information of all the presets.

4.2.2 Calling Presets

Purpose:

This feature enables the camera to move to a specified preset.

Steps:

1. Click the button **PTZ** in the lower-right corner of the PTZ setting interface; or press the PTZ button on the front panel or click the PTZ Control icon in the quick setting bar, or select the PTZ option in the right-click menu to show the PTZ control panel.
2. Choose **Camera** in the dropdown list.
3. Click the  button to show the **General** settings in the PTZ control.
4. Click to enter the preset No. in the corresponding text field.
5. Click the **Call Preset** button to call it.

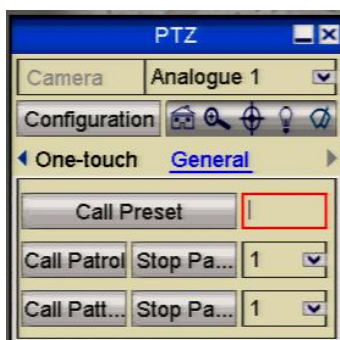

Figure 4.2.2.5. PTZ Panel - General

4.2.3 Customising Patrols

General:

The DVR uses a standardised method of controlling Tours/Patrols. These may not always work with every PTZ. Most PTZs use allocated preset numbers to trigger tours/patrols so these will normally work, providing the presets are within the range that the DVR can control.

Purpose:

Tours/Patrols can be set to move the PTZ to different key points and have it stay there for a set duration before moving on to the next key point. The key points correspond to the presets. The presets can be set following the steps above in **Customising Presets**.

Steps:

1. Enter the PTZ Control interface.
Menu>Video>PTZ



Figure 4.2.3.1 PTZ Settings

2. Select patrol No. in the drop-down list of patrol.
3. Click the **Set** button to add key points for the patrol.

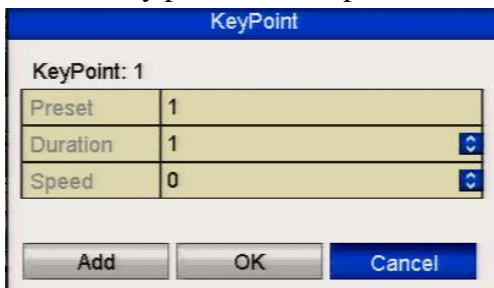

Figure 4.2.3.3 Key point Configuration

4. Configure key point parameters, such as the key point No., duration of staying at key point (dwell time) and speed of patrol. The key point corresponds to the preset. The **Key Point No.** determines the order at which the PTZ will follow while cycling through the patrol. The **Duration** refers to the dwell time it stays at the corresponding key point. The **Speed** defines the speed at which the PTZ will move from one key point to the next.
5. Click the **Add** button to add the next key point to the patrol, or you can click the **OK** button to save the key point to the patrol.
 You can delete all the key points by clicking the **Clear** button for the selected tour/patrol, or click the **Clear All** button to delete all the key points for all tours/patrols.

4.2.4 Calling Patrols

General:

The DVR uses a standardised method of controlling Tours/Patrols. These may not always work with every PTZ. Most PTZs use allocated preset numbers to trigger tours/patrols so these will normally work, providing the presets are within the range that the DVR can control.

Purpose:

Calling a patrol makes the PTZ initiate the predefined patrol number.

Steps:

1. Click the button **PTZ** in the lower-right corner of the PTZ setting interface; or press the PTZ button on the front panel or click the PTZ Control icon in the quick setting bar, or select the PTZ option in the right-click menu to show the PTZ control panel.
2. Click the  button to show the general settings of the PTZ control.

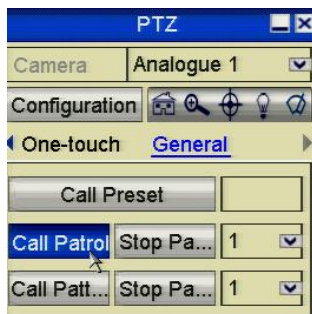

Figure 4.2.4.2 PTZ Panel - General

3. Select a patrol in the dropdown list and click the **Call Patrol** button to call it.
4. You can click the **Stop Patrol** button to stop calling it. Note that most PTZ cameras trigger tours using a defined CALL PRESET number and may not work using this utility option.

4.2.5 Customising Patterns

General:

Patterns can only be recorded if the PTZ being used has the capability of running patterns.

Purpose:

Patterns can be set by recording the movement of the PTZ. You can call the pattern to make the PTZ movement according to the predefined path.

Steps:

1. Enter the PTZ Control interface - Menu > Video > PTZ

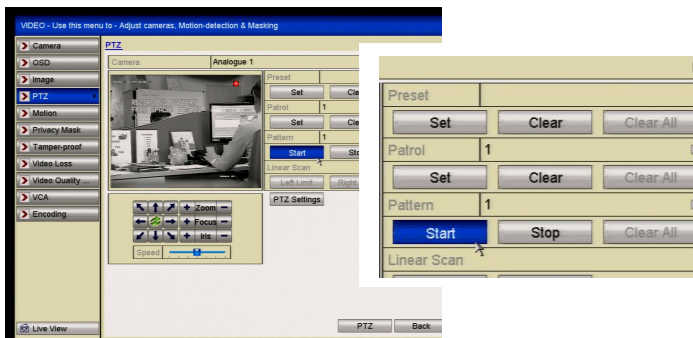

Figure 4.2.5.1 PTZ Settings

2. Choose pattern number from the dropdown list.
3. Click the **Start** button and click corresponding buttons in the control panel to move the PTZ camera. The movement of the PTZ is then recorded as the pattern.
4. Click the **Stop** button to stop the PTZ.

4.2.6 Calling Patterns

Purpose:

Running the pattern.

Steps:

1. Click the button **PTZ** in the lower-right corner of the PTZ setting interface; or press the PTZ button on the front panel or click the PTZ Control icon in the quick setting bar, or select the PTZ option in the right-click menu to show the PTZ control panel.
2. Click the  button to show the general settings of the PTZ control.

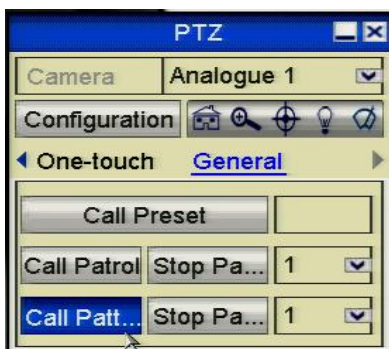

Figure 4.2.6.1 PTZ Panel - Pattern

3. Click the **Call Pattern** button to call it.
4. Click the **Stop Pattern** button to stop it.

4.2.7 Customising Auto Scans

Purpose:

The Auto Scan can be enabled to trigger the PTZ to scan between two horizontal positions.

This function is not supported by certain models.

Steps:

1. Enter the PTZ Control interface.
Menu > Video > PTZ

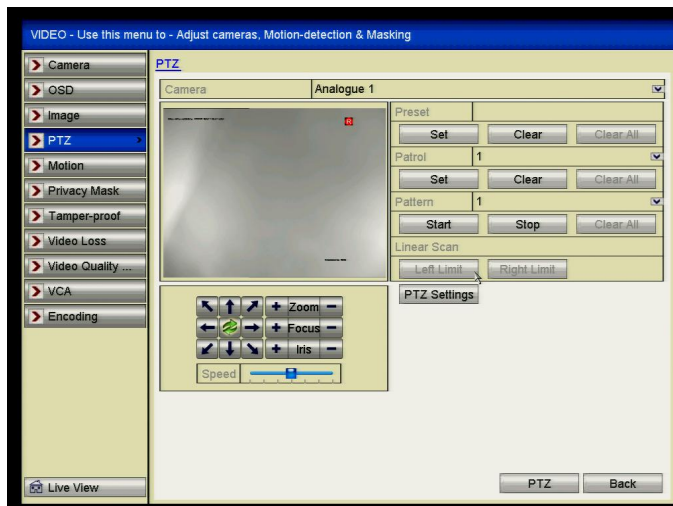

Figure 4.2.7.1 PTZ Settings

2. Use the directional button to move the PTZ camera to the location where you want to start the Auto Scan and click the **Left Limit** button then move to where the Auto Scan stops and press the **Right Limit** button.
The PTZ starts the Auto Scan from the left limit to the right limit. The distance should be no more than 180°.

4.2.8 Calling Auto Scans

Purpose:

Follow the procedure to call the Auto Scan.

Steps:

1. Click the button **PTZ** in the lower-right corner of the PTZ setting interface; or press the PTZ button on the front panel or click the PTZ Control icon in the quick setting bar to enter the PTZ setting menu in live view mode.
2. Click the  button to show the one-touch function of the PTZ control.



Figure 4.2.8.1 PTZ Panel – Linear Scan

3. Click **Linear Scan (Auto Scan)** button to start the Auto Scan and click again to stop it.
You can click the **Restore** button to clear the defined left limit and right limit points and the reboot the PTZ to make settings take effect.

4.2.9 One-touch Park

Purpose:

Some PTZ cameras have a predefined park action option that allows the PTZ to resume a (scan, preset, patrol etc.) automatically after a period of inactivity (park time).

Steps:

1. Click the button **PTZ** in the lower-right corner of the PTZ setting interface; or press the PTZ button on the front panel or click the PTZ Control icon in the quick setting bar to enter the PTZ setting menu in live view mode.
2. Click the  button to show the one-touch function of the PTZ control.



Figure 4.2.9.1 PTZ Panel - One-touch

3. There are 3 one-touch park types selectable, click the corresponding button to activate the park action.

Park (Quick Patrol): The dome starts patrol from the predefined preset 1 to preset 32 in order after the park time. Any undefined preset will be skipped.

Park (Patrol 1): The dome starts moving according to the predefined patrol 1 settings after the park time.

Park (Preset 1): The dome moves to the predefined preset 1 location after the park time expires.

Note that the park time can only be set through the speed dome configuration interface, by default the value is 5s.

4. Click the button again to inactivate it.

4.3 PTZ Control Panel

To enter the PTZ control panel, there are two ways supported.

OPTION 1:

In the PTZ settings interface, click the **PTZ** button on the lower-right corner which is next to the Back button.

OPTION 2:

In the Live View mode, you can press the PTZ Control button on the front panel or on the remote control, or choose the PTZ Control icon, or select the PTZ option in the right-click menu.

Click the **Configuration** button on the control panel, and you can enter the PTZ Settings interface.

In PTZ control mode, the PTZ panel will be displayed when a mouse is connected with the device. If no mouse is connected, the PTZ icon appears in the lower-left corner of the window, indicating that this camera is in PTZ control mode.



Figure 4.3.1 PTZ Panel Views 1 ~ 3

Icon	Description	Icon	Description	Icon	Description
	Direction button and the auto-cycle button		Zoom+, Focus+, Iris+		Zoom-, Focus-, Iris-
	The speed of the PTZ movement		Light on/off		Wiper on/off
	3D-Zoom		Image Centralisation		Menu
	Switch to the PTZ control interface		Switch to the one-touch control interface		Switch to the general settings interface
	Previous item		Next item		Start pattern / patrol
	Stop the patrol / pattern movement		Exit		Minimise windows

Chapter 5 Recording Settings

5.1 Configuring Recording Parameters

Before you start:

1. Make sure that the HDD has already been installed. If not, please install an HDD and format it. (Menu>Drives>General) Tick box on HDD being formatted.

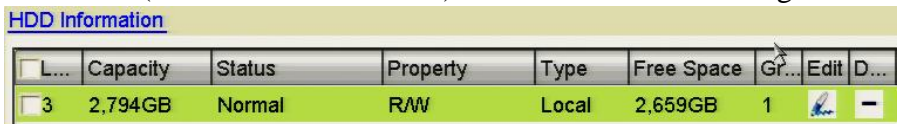

Figure 5.1.1 HDD- General

2. Click **Advance** to check the storage mode of the HDD.
 - 1) Whether the HDD mode is *Quota*, please set the maximum record capacity. For detailed information, see *Chapter 0. Configuring Quota Mode*.
 - 2) If the HDD mode is *Group*, you should set the HDD group. For detailed information, see *Chapter 5.9 Configuring HDD Group for Recording*.

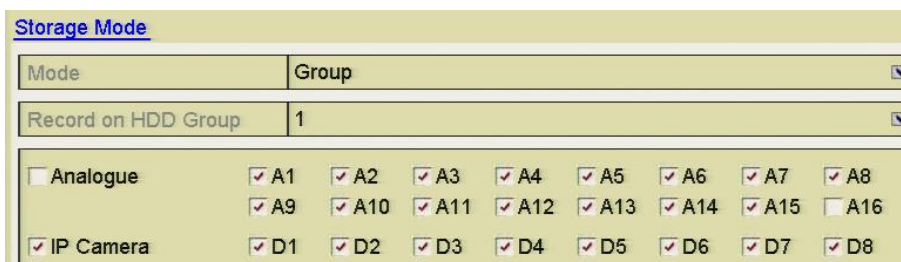

Figure 5.1.2 HDD- Advanced

Steps:

1. Enter the Encoding settings interface to configure the encoding parameters:
Menu>Video>Encoding

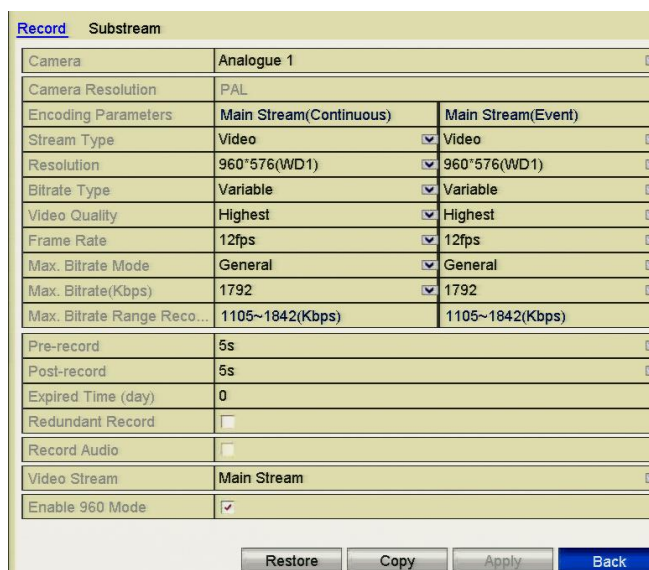

Figure 5.1.3 Encoding Parameters

2. Set the parameters for recording.

1) Select the **Record** tab to configure.

2) Select a camera number in the camera drop down list.

You can configure the stream type, the resolution, the video quality and other parameters on demand for Main Stream (Continuous) and Main Stream (Event) respectively.

The **Input Resolution** of camera connected will be displayed in the live view for 5 seconds when the camera is connected or when the DVR is powered on. The input resolution includes the resolution and frame rate of the camera, e.g. 1080P25.

3) You can also configure additional parameters, including pre-record, post-record time, expired time, redundant record (this option is only available when the HDD mode is *Group*) and whether you want to record audio.

- **Pre-record:** The time you set to record before the scheduled time or event. For example, if an alarm triggers the recording at 10:00, if you set the pre-record time at 5 seconds, the camera records it at 9:59:55.
- **Post-record:** The time you set to record after the event or scheduled time. For example, if an alarm triggers the recording which ends at 11:00, if you set the post-record time at 5 seconds, it records until 11:00:05.
- **Expired Time:** The expired time is the longest time for a recorded file to be kept on the HDD. If the deadline is reached, the file will be deleted. You can set the expired time to 0, and then the file will not be deleted. The actual keeping time for the file should be determined by the capacity of the HDD.
- **Redundant Record:** The redundant record is to decide whether you want the camera to save the recorded files on the redundant HDD. You must configure the redundant HDD in HDD settings. For detailed information, see *Chapter 5.8. Configuring Redundant Recording*.
- **Record Audio:** Check the Record Audio checkbox to record sound, otherwise record images without sound.
- **Video Stream:** Main stream and sub-stream are selectable for recording. When you select sub-stream, you can record for a longer time with the same storage space.
- **Enable 960 Mode:** The option is supported by analogue cameras. Enabling the 960 mode to enable the WD1 resolution for main stream, otherwise, the resolution supports up to 4CIF. This option is not supported using TVI cameras although the WD1 resolution is available all the time.

4) Click **Apply** to save the settings.

5) You can copy the settings to other channels by clicking **Copy** providing the settings are valid for use with other cameras.

You can only copy the same settings to other cameras of the same type e.g. if channels 1, 2 and 3 are connected to TVI cameras and channel 4 is connected to an analogue, the settings set for channel 1 can only be copied to channels 2 and 3.

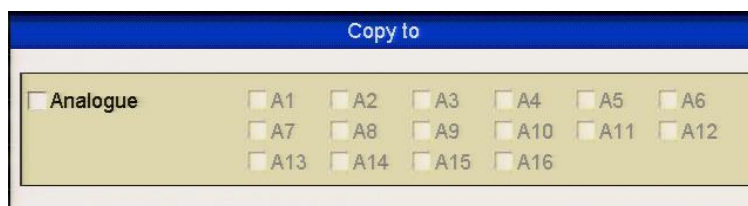

Figure 5.1.4 Copy Camera Settings

3. Set encoding parameters for sub-stream.

- 1) Select the **Substream** tab.

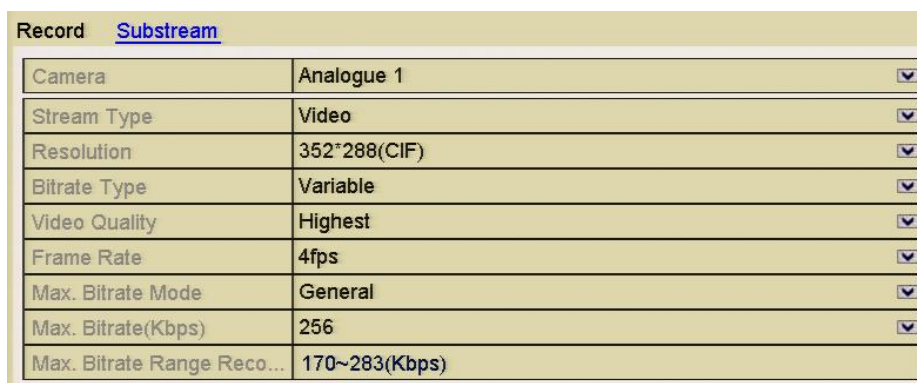

Figure 5.1.5 Sub-stream Encoding

- 2) Select a camera in the camera dropdown list.
- 3) Configure the parameters.
- 4) Click **Apply** to save the settings.
- 5) (Optional) If the parameters can also be used to other cameras, click **Copy** to copy the settings to other channels.

You can only copy the same settings to other cameras of the same type e.g. if channels 1, 2 and 3 are connected to TVI cameras and the channel 4 is connected to an analogue camera, the settings set for channel 1 can only be copied to channels 2 and 3.

5.2 Configuring Record Schedule

The MEGA204, MEGA208, MEG216, MAX316 and MAX416 support continuous, alarm, motion, motion | alarm, motion & alarm and VCA triggered recording types.

Purpose:

Set the record schedule so that the camera will automatically start/stop recording according to the configured schedule.

Steps:

1. Enter the Record Schedule interface.
Menu> Schedule> Schedule

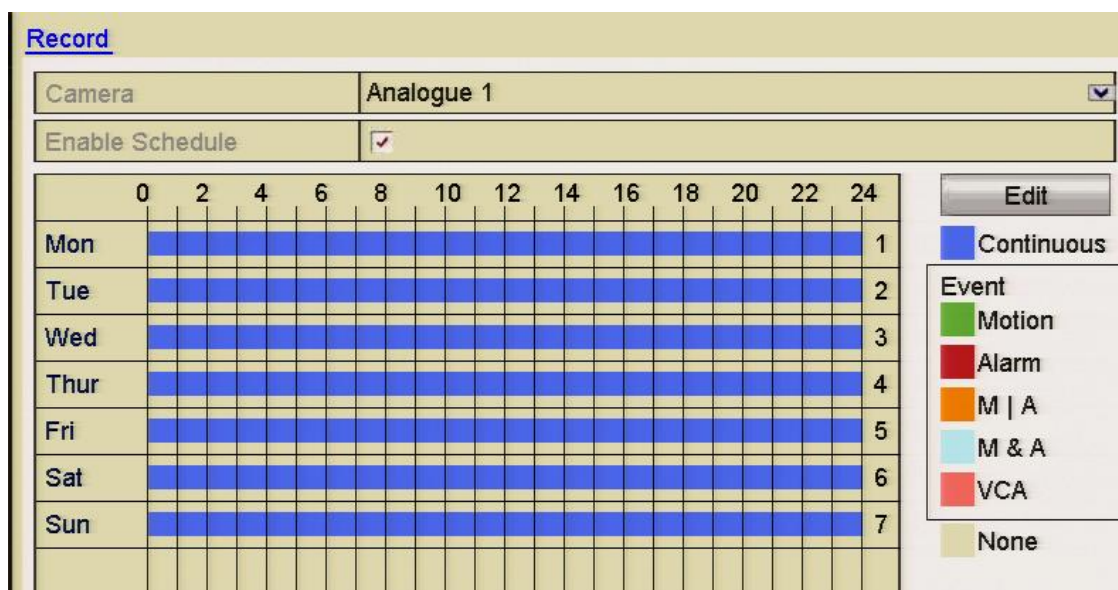

MEGA DVR Range

Figure 5.2.1 Record Schedule

2. Choose the camera you want to configure in the Camera dropdown list.
3. Check the Enable Schedule box.
4. Configure the record schedule.

Edit the schedule

- 1) Click **Edit**.
- 2) In the message box, you can choose the day to which you want to set schedule.

- 3) To schedule an all-day continuous recording, check the checkbox after the **All Day** item.

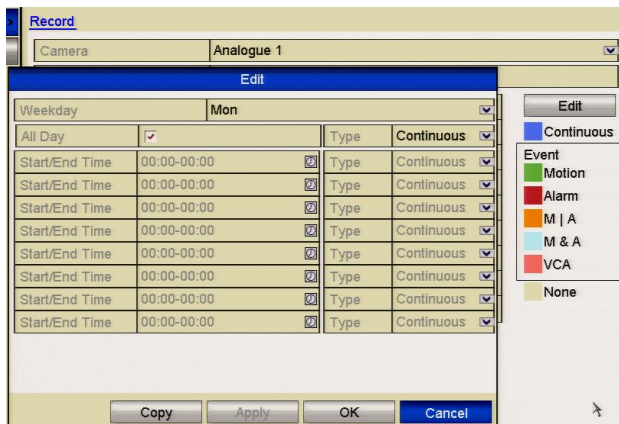

Figure 5.2.2 Edit Schedule- All Day

- 4) To arrange event schedules, leave the **All Day** checkbox blank and set the Start/End time.

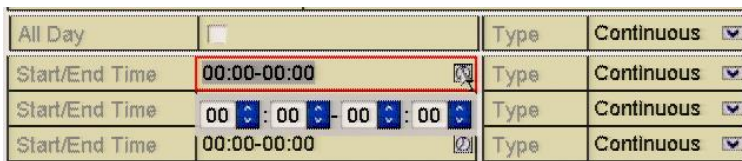

Figure 5.2.3 Edit Schedule- Set Time Period

Up to 8 periods can be configured for each day. The time periods cannot overlap each other.

Repeat the above steps 1-4 to schedule recording for other days in the week. If the schedule can also be set for other days, click **Copy**.

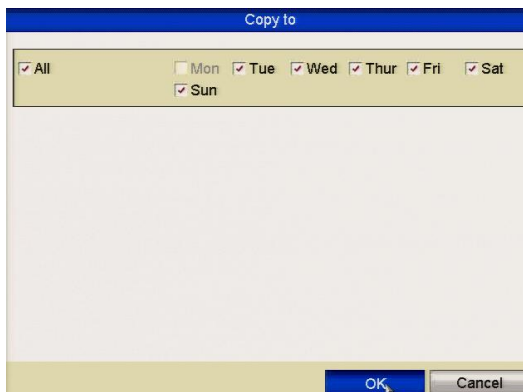

Figure 5.2.4 Copy Schedule for Other Days

The **Holiday** option is available when you enable holiday schedule in **Holiday settings**. See *Chapter 5 Configuring Holiday Recording*.

- 5) Click **OK** to save setting and back to upper level menu.

Draw the schedule

- 1) Click on the color icon to select a record type required. The event list on the right-side of the interface explains each record option.

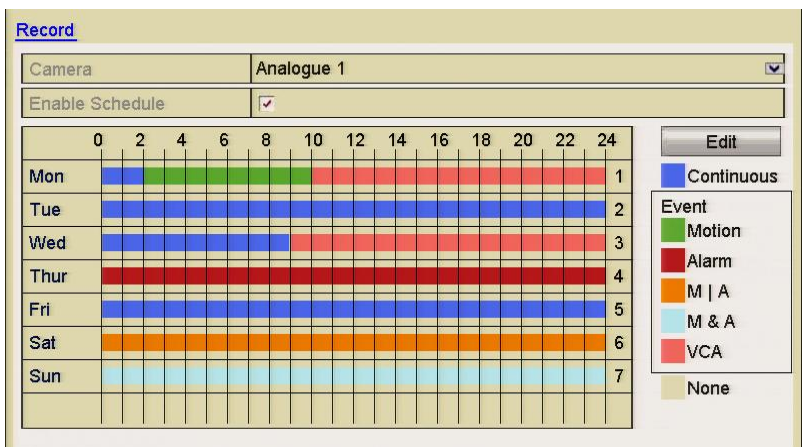

Figure 5.2.5 Draw the Schedule

Description of the colour icons are shown below.

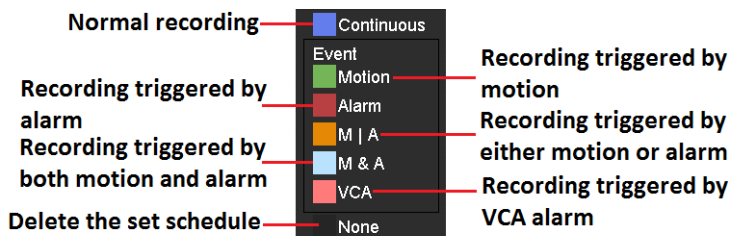

Figure 5.2.6 Descriptions of the Color Icons

- 2) Click and drag the mouse on the schedule.
- 3) Click on the other area except for the schedule table to finish and exit the drawing.

You can repeat steps to set schedules for other channels. If the settings can also be used for other channels, click **Copy** and then choose the channel to which you want to copy.

5. Click **Apply** in the Record Schedule interface to save the settings.

5.3 Configuring Motion Detection

Purpose:

Follow the steps to set the motion detection parameters. In the live view mode, once a motion detection event takes place, the DVR can initiate a number of options. Enabling the motion detection function can trigger certain channels to start recording, trigger full screen monitoring, output an audio warning, notify a surveillance center and send emails etc.

Steps:

1. Enter the Motion Detection interface.
Menu>Video>Motion

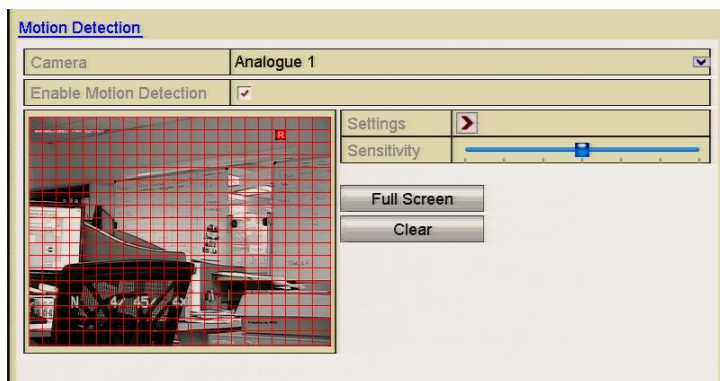

Figure 5.3.1 Motion Detection

2. Configure Motion Detection:

- 1) Choose the camera you want to configure.
- 2) Check the checkbox after **Enable Motion Detection**.
- 3) Drag and draw the area for motion detection using the mouse. If you want to set the motion detection for the whole area, click **Full Screen**. To clear the motion detection area, click **Clear**.
- 4)

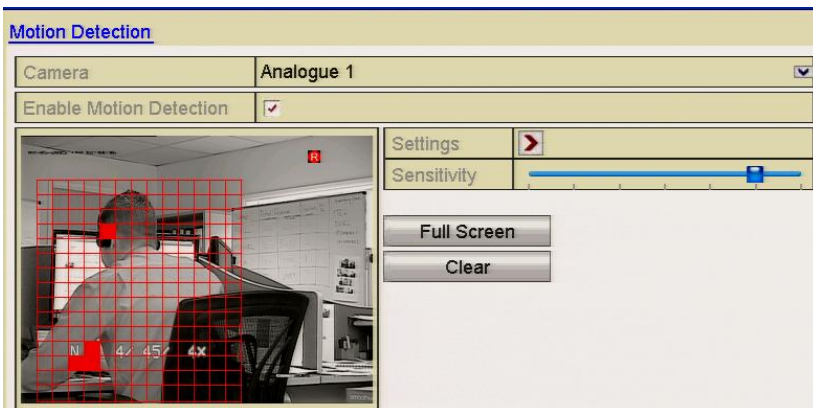

Figure 5.3.2 Motion Detection- Mask

- 5) Click **Settings**, and the message box for channel information displays.

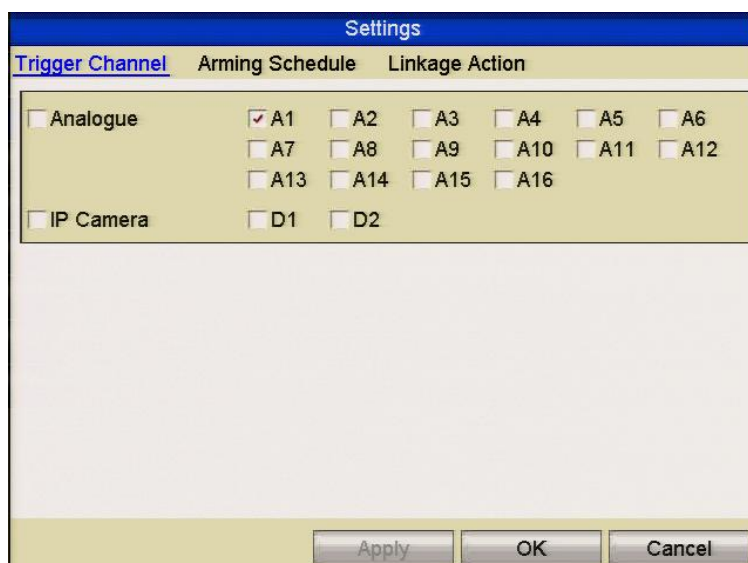

Figure 5.3.3 Motion Detection Settings

- 6) Select the channels which you want the motion detection event to trigger recording.
 - 7) Click **Apply** to save the settings.
 - 8) Click **OK** to back to the upper level menu.
 - 9) Exit the Motion Detection menu.
- 3. Configuring the schedule.**
Please refer to *Chapter 5. Configuring Record Schedule*, but choose Motion as the record type.

5.4 Configuring Alarm Triggered Record

Purpose:

Follow the procedure to configure alarm trigger recording.

Steps:

1. Enter the Alarm setting interface.

Menu> Setup> Alarm

Alarm Input List		
Alarm Input No.	Alarm Name	Alarm Type
Local<-1		N.O
Local<-2		N.O
Local<-3		N.O
Local<-4		N.O
Local<-5		N.O
Local<-6		N.O
Local<-7		N.O

Alarm Output List		
Alarm Output No.	Alarm Name	Dwell Time
Local->1		5s
Local->2		5s
Local->3		5s
Local->4		5s

Figure 5.4.1 Alarm Settings

2. Click the **Alarm Input** tab.

Alarm Status		Alarm Input	Alarm Output
Alarm Input No.		Local<-1	
Alarm Name		test	
Type		N.O	
Enable		<input checked="" type="checkbox"/>	
Settings			

Figure 5.4.2 Alarm Settings- Alarm Input

- 1) Select Alarm Input number and configure alarm parameters.
- 2) Choose N.O (normally open) or N.C (normally closed) for alarm type.
- 3) Click the Enable checkbox.
- 4) Click the Settings button.

Settings			
Trigger Channel	Arming Schedule	Linkage Action	PTZ Linking
<input type="checkbox"/> Analogue	<input type="checkbox"/> A1 <input type="checkbox"/> A2 <input type="checkbox"/> A3 <input type="checkbox"/> A4 <input type="checkbox"/> A5 <input type="checkbox"/> A6		
	<input type="checkbox"/> A7 <input type="checkbox"/> A8 <input type="checkbox"/> A9 <input type="checkbox"/> A10 <input type="checkbox"/> A11 <input type="checkbox"/> A12		
	<input type="checkbox"/> A13 <input type="checkbox"/> A14 <input type="checkbox"/> A15 <input type="checkbox"/> A16		
<input type="checkbox"/> IP Camera	<input type="checkbox"/> D1 <input type="checkbox"/> D2		

Figure 5.4.3 Alarm Handling

- 5) Choose the alarm triggered recording channel.
- 6) Click the checkbox to select channel.
- 7) Click **Apply** to save settings.

8) Click **OK** to return to previous menu.

Repeat the above steps to configure other alarm input parameters.

If the setting can also be applied to other alarm inputs, click **Copy** and choose the alarm input number.

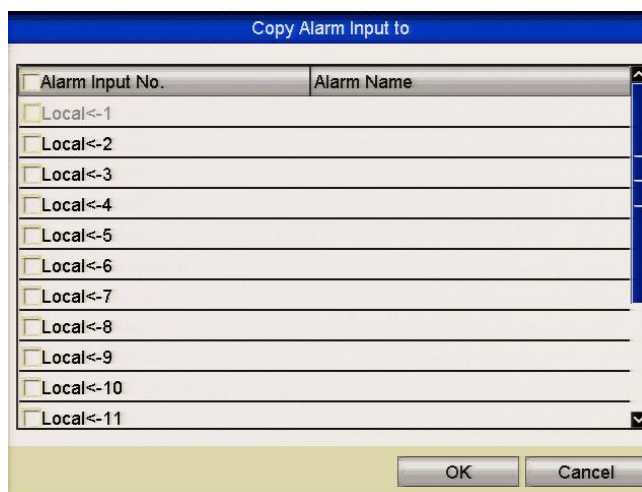

Figure 5.4.4 Copy Alarm Input

3. Configure the schedule.

Please refer to the step 4 of *Chapter 5. Configuring Record Schedule* but select Alarm as the record type.

5.5 Configuring VCA (Video Content Analysis) Record

Purpose:

The DVR supports the VCA (line crossing detection and intrusion detection) triggered recording. The VCA settings and VCA event triggered recording is supported on 2 analogue cameras.

Steps:

1. Enter the VCA settings interface and select a camera for the VCA settings.

Menu> Video> VCA

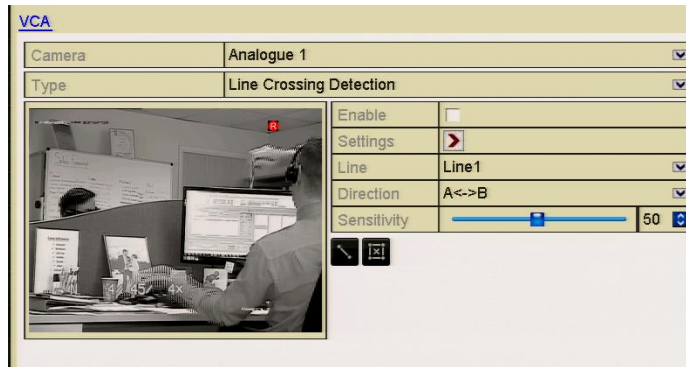

Figure 5.5.1 VCA Settings

2. Configure the detection rules for VCA events. For details, see *Chapter 8. Detecting VCA Alarm.*
3. Click the **Settings** icon to configure the alarm linkage actions for VCA events. Select **Trigger Channel** tab and select one or more channels which will start to record when VCA alarm is triggered. Click **Apply** to save the settings

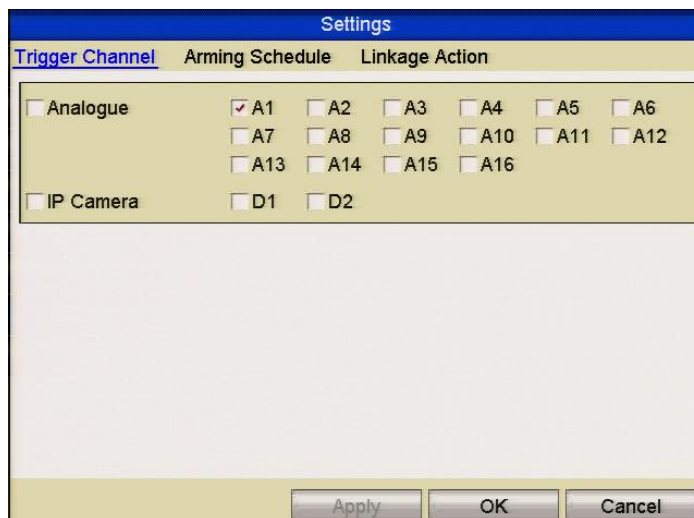

Figure 5.5.2 Set Trigger Camera of VCA Alarm

The PTZ Linking function is only available for the VCA settings of IP cameras.

4. Enter Record Schedule settings interface (Menu> Schedule> Schedule>Record and then set VCA as the record type. For details, see *Chapter 5. Configuring Record Schedule*.

5.6 Configuring Manual Record

Purpose:

Follow the steps to set parameters for the manual record. Using manual record, you are overriding the record schedule and using highest record settings. Therefore disk space will be used much quicker. This option is only used for emergency recording when the schedule is not running 24 x 7. When the DVR is rebooted the manual settings are cancelled.

Steps:

1. Enter the Manual settings interface.

Menu> Instant

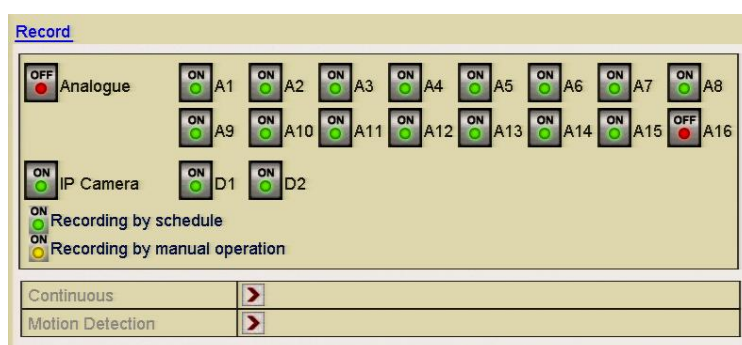

Figure 5.6.1 Manual Record

2. Enable manual record.
3. Click the **Analogue** status icon **OFF** to enable manual record on all channels or click the required **OFF** status icon to change camera number status to **ON**.
4. Disable manual record.
Click the **Analogue** status icon **ON** to disable manual record of all channels or click the required **ON** status icon to change camera number status to **OFF**.

REMINDER

MANUAL RECORD IS CANCELLED FOLLOWING A REBOOT.

5.7 Configuring Holiday Record

Purpose:

The Holiday Record feature allows you to set on a date basis, a different recording schedule.

Steps:

1. Enter the Record setting interface.
Menu>Schedule>
2. Choose **Holiday** in the left bar.

No.	Holiday Name	Status	Start Date	End Date	Edit
1	Holiday1	Disabled	1.Jan	1.Jan	
2	Holiday2	Disabled	1.Jan	1.Jan	
3	Holiday3	Disabled	1.Jan	1.Jan	
4	Holiday4	Disabled	1.Jan	1.Jan	
5	Holiday5	Disabled	1.Jan	1.Jan	
6	Holiday6	Disabled	1.Jan	1.Jan	
7	Holiday7	Disabled	1.Jan	1.Jan	
8	Holiday8	Disabled	1.Jan	1.Jan	
9	Holiday9	Disabled	1.Jan	1.Jan	
10	Holiday10	Disabled	1.Jan	1.Jan	
11	Holiday11	Disabled	1.Jan	1.Jan	

Figure 5.7.1 Holiday Settings

3. Enable Edit Holiday schedule.
 - 1) Click to enter the Edit interface.

Edit	
Holiday Name	Holiday1
Enable	<input type="checkbox"/>
Mode	By Month
Start Date	Jan 1
End Date	Jan 1
<input type="button" value="Apply"/> <input type="button" value="OK"/> <input type="button" value="Cancel"/>	

Figure 5.7.2 Edit Holiday Settings

- 2) Click the **Enable**.checkbox.
- 3) Select Mode from the dropdown list.
There are three different modes for the date format to configure holiday schedule. By Month, By Week, and By Day are selectable.
- 4) Set the start and end date.
- 5) Click **Apply** to save settings.
- 6) Click **OK** to exit the Edit interface.
4. Configure the record schedule.

Please refer to the *Chapter 5.2 Configuring Record Schedule* and choose Holiday in the Schedule dropdown list. Alternatively you can draw the schedule on the Holiday timeline.

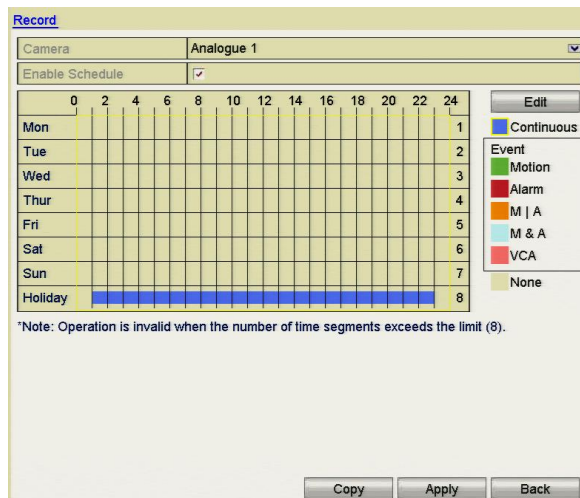

Figure 5.7.3 Edit Schedule- Holiday

Up to 8 periods can be configured for each day. The time periods must not overlap. In the schedule time table, both the holiday schedule and the normal day schedule are displayed.

Repeat the above step 4 to set a Holiday schedule for other channels. If the holiday schedule is applicable for use with other channels, click **Copy** and choose the channel you want to apply the settings.

5.8 Configuring Redundant Recording

Purpose:

Enabling redundant recording, allows recorded files held on the hard drive to be automatically duplicated on another hard drive setup as the redundant HDD.

Before you start:

You must set the Storage mode in the HDD advanced settings to Group before you set the HDD property to Redundant. For detailed information, please refer to *Chapter 9.8 Managing HDD Group*. There should be at least another HDD which is in Read/Write status.

Steps:

1. Enter HDD Information interface.

Menu> Drives>General

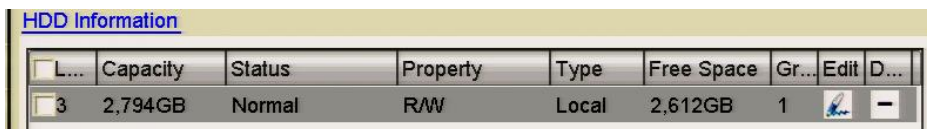

Figure 5.8.1 HDD General

2. Select the **HDD** and click **Edit** to enter the Local HDD Settings interface.

- 1) Set the HDD property to Redundant by clicking Redundancy.

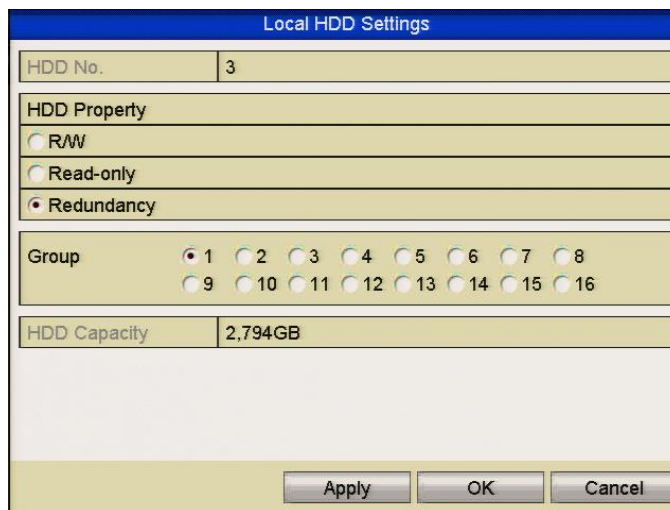

Figure 5.8.2 HDD General-Editing

- 2) Click **Apply** to save the settings.
- 3) Click **OK** to return to previous menu.

3. Enter the Record setting interface.

Menu> Video> Encoding

- 1) Select the **Record** tab.

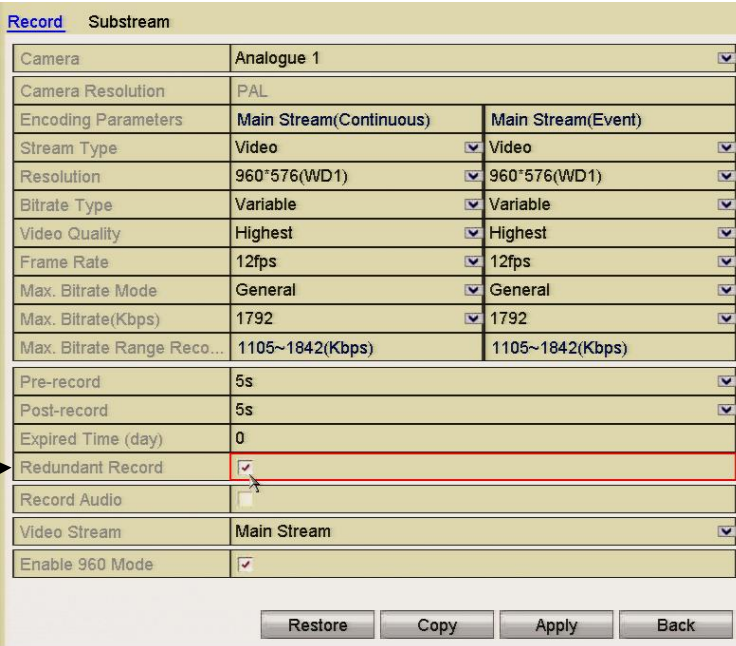

Record Substream	
Camera	Analogue 1
Camera Resolution	PAL
Encoding Parameters	Main Stream(Continuous) Main Stream(Event)
Stream Type	Video Video
Resolution	960*576(WD1) 960*576(WD1)
Bitrate Type	Variable Variable
Video Quality	Highest Highest
Frame Rate	12fps 12fps
Max. Bitrate Mode	General General
Max. Bitrate(Kbps)	1792 1792
Max. Bitrate Range Reco...	1105~1842(Kbps) 1105~1842(Kbps)
Pre-record	5s
Post-record	5s
Expired Time (day)	0
Redundant Record	<input checked="" type="checkbox"/>
Record Audio	<input type="checkbox"/>
Video Stream	Main Stream
Enable 960 Mode	<input checked="" type="checkbox"/>

Restore Copy Apply Back

Figure 5.8.3 Encoding Parameters

- 2) Select Camera you want to configure.
- 3) Click on the **Redundant Record** checkbox.
- 4) Click **Apply** to save settings.

If the encoding parameters are required to be applied to other cameras, click **Copy** and choose the channel you want to apply the settings to.

5.9 Configuring HDD Group for Recording

Purpose:

You can group the HDDs and save the recorded files in certain HDD groups.

Steps:

1. Enter HDD setting interface.
Menu>Drives>Advanced
2. Select **Advanced**.
Check whether the storage mode of the HDD is in Group mode. If not, set it to Group. For detailed information, please refer to *Chapter 9.8 Managing HDD Groups*.
3. Select **General**.
Click signature under **Edit** to enter editing interface.
4. Configuring HDD group.
 - 1) Choose a group number for the HDD group.

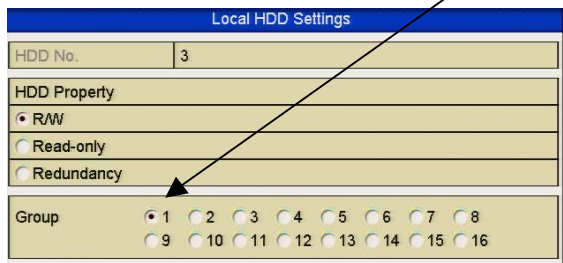

Figure 5.9.1
Drives General

- 2) Click **Apply** to save your settings.
 - 3) Click **OK** to return to previous menu.

Repeat the above steps to configure more HDD groups.
5. Choose the Channels which you want to save the recorded files in the appropriate HDD group.
 - 1) Select **Advanced**.

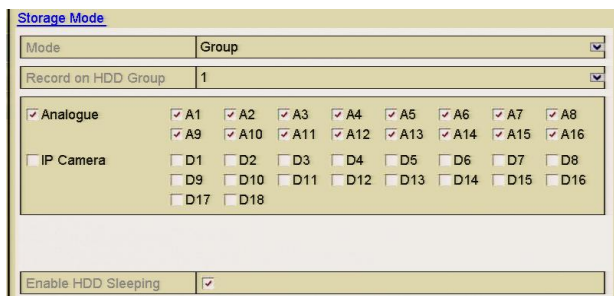

Figure 5.9.2. HDD Advanced

- 2) Choose Group number from the dropdown list in **Record on HDD Group**
 - 3) Check the channels you want to save in this group.
 - 4) Click **Apply** to save settings.

After you have configured the HDD groups, you can configure the Recording settings following the procedure provided in *Chapter 5*.

5.10 File Protection

Purpose:

You can lock the recorded files or set the HDD property to Read-only to protect the record files from being overwritten.

Protect file by locking the record files

Steps:

1. Enter Playback setting interface.
Menu> Backup

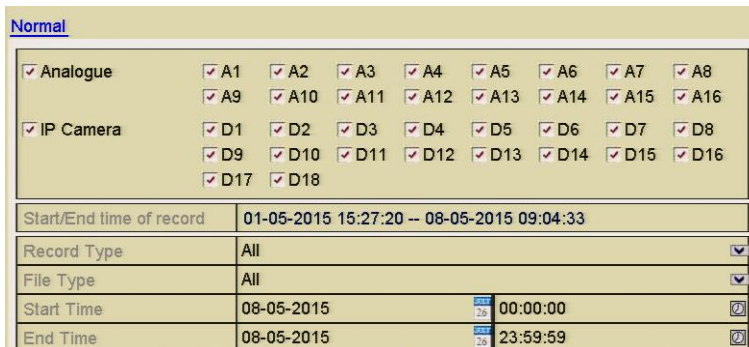

Figure 5.10.1 Backup

2. Select the channels you want to investigate by clicking the checkbox/es.
3. Configure the record type, file type, start time and end time.
4. Click **Search** to show the results.

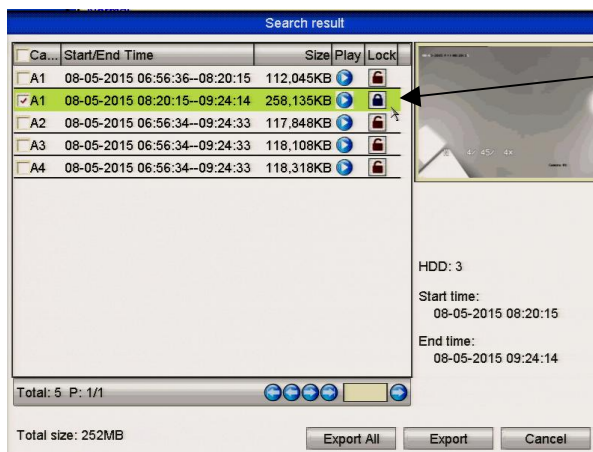



Figure 5.10.2 Export- Search Result

5. Protect the recorded files.

1) Find the recorded file/s you want to protect and then click the  icon which will turn to  indicating that the file is locked.

Files that are still in the process of being written, cannot be locked.

2) Click  to change it to  to unlock the file and the file is not protected.

Note that when unlocking a file, if it is the earliest file on the system, it will be automatically overwritten when the DVR is in overwrite mode.

Protect file by setting HDD property to Read-only

Before you start:

To edit HDD property, you need to set the storage mode of the HDD to Group. See *Chapter 9.8. Managing HDD Group.*

Steps:

1. Enter HDD setting interface.

Menu> Drives

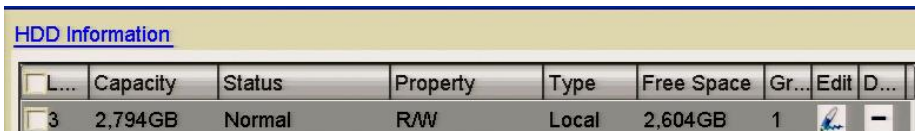

Figure 5.10.3 Drives General

2. Click the signature under **Edit** to edit the HDD you want to protect.

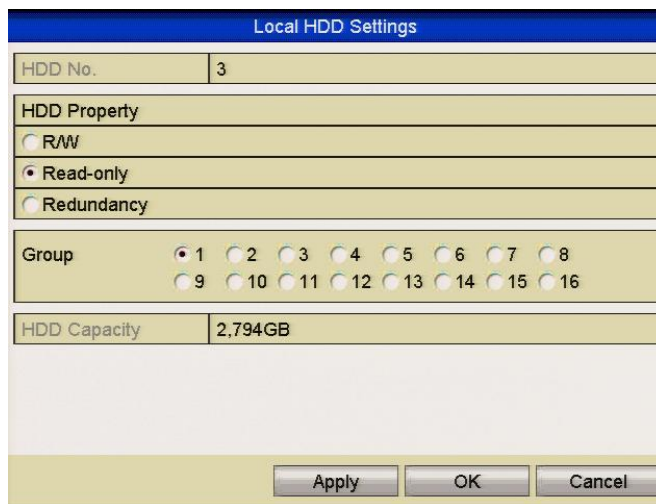

Figure 5.10.4 Drives General- Editing

3. Set the HDD to Read-only.
4. Click **OK** to save settings and return to previous menu.

- You cannot save any files to an HDD if in Read-only mode. If you want to save files you must change the properties to R/W (Read/Write).
- If there is only one HDD installed and it is set to Read-only, the DVR cannot record any files. Only preview mode is available.
- If you set the HDD to Read-only whilst the DVR is saving files, then the file will be saved in the next R/W HDD. If there is only one HDD available, the recording will be stopped.

Chapter 6 Playback

6.1 Playing Back Recorded Files

6.1.1 Playing Back by Channel

Purpose:

Play back the recorded video files of a specific channel in the live view mode.

Channel switch is supported.

● **OPTION 1**

Choose a channel in live view mode using the mouse and click the play button in the quick setting toolbar.



Play Button

Only record files recorded during the last five minutes on this channel will be played back.

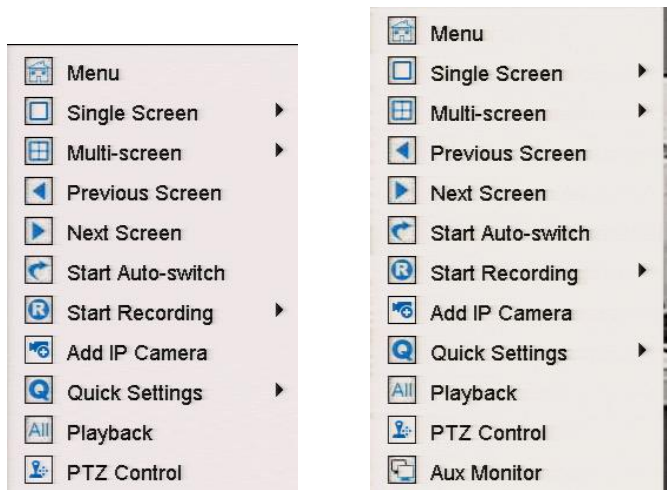

Figure 6.1.1.1 Instant Playback Interface

● **OPTION 2**

Steps:

1. Enter the Playback interface.
 Mouse: right click a channel in live view mode and select Playback from the menu, as shown below.



MEGA204, MEGA208 & MEGA216 MAX316 & MAX416

Figure 6.1.1.2 Right-click Menu in Preview Mode

The Aux Monitor option (MAX316 & MAX416 only)

Front Panel: Press **PLAY** button to play back recorded files for a channel in single-screen live view mode. In multi-screen live view mode, the recorded files of the top-left channel will be played back. For the MAX316 and MEG416 pressing numerical buttons will switch playback to the corresponding camera during playback process.

2. Playback management

The toolbar in the bottom part of Playback interface can be used to control playback progress, as shown below.

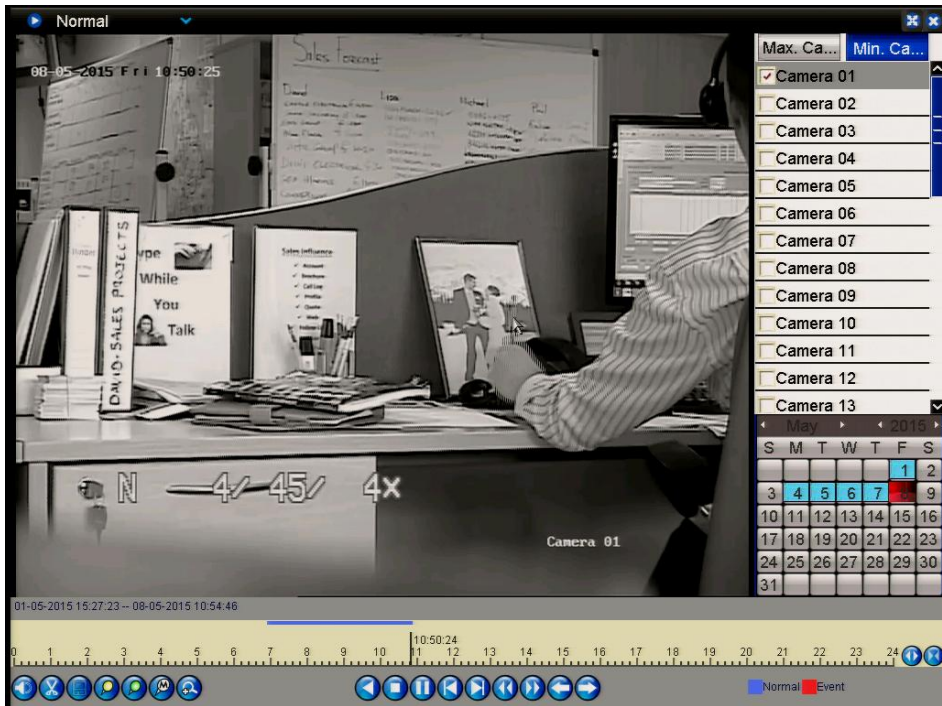

Figure 6.1.1.3 Playback Interface

Click the channel(s) if you want to switch playback to another channel or execute simultaneous playback of multiple channels.



Figure 6.1.1.4 Toolbar of Playback

Button	Operation	Button	Operation	Button	Operation
	Audio on /Mute		Start/Stop clipping		Save Clip(s)
	Add default tag		Add customised tag		Tag management
	Digital Zoom		30secs backwards		30 secs forwards
	Pause reverse play/ Reverse play/ Single-frame reverse play		Pause play/ Play/ Single-frame play		Stop
	Previous day		Next day		Full Screen
	Speed Up		Speed Down		Exit
	Process bar		Video type bar Blue Normal Red Event Recording		Time Bar Zoom In Time Bar Zoom Out

- 01-05-2015 15:27:23 -- 08-05-2015 10:54:46 indicates the start time/end time of the record files.
- represents normal recording (manual or schedule); represents event recording (motion, alarm, motion | alarm, motion & alarm).
- Progress Bar: click any point of the progress bar to locate selected frames.

6.1.2 Playing Back by Time

Purpose:

Play back video files recorded in specified time duration. Multi-channel simultaneous playback and channel switch are supported.

Steps:

1. Enter playback interface.
Menu>Playback
2. Check the checkbox of channel(s) in the channel list and then double-click to select a date on the calendar.



Figure 6.1.2.1 Playback Calendar

In the Playback interface:

The toolbar at the bottom of the Playback interface can be used to control playing process. Please refer to *Chapter 6. Playing Back by Channel* for the playback interface and toolbar information.

6.1.3 Playing Back by Event Search

Purpose:

Play back recorded files on one or several channels using event type (motion detection, alarm input or VCA). Channel sequencing is supported.

Playback by alarm input search is not supported by some DVR models.

Figure 6.1.3.1 Video Search by Motion Detection

Steps:

1. Enter the playback interface.
Menu>Playback (Top Left Corner)
2. Click and select to enter the Event Playback interface.
3. Select **Alarm Input, Motion, Line Crossing Detection, Intrusion Detection**

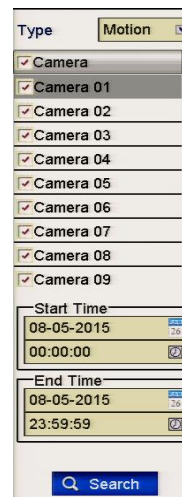
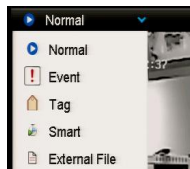

Figure 6.1.3.2 Playback Options

4. Click **Search**, and the record files matching the search conditions will be displayed on a list.
5. Select and click button to play back the record files.

You can click **Back** to return to the search interface.

If there is only one channel triggered, clicking button takes you to Full-screen Playback interface of this channel.

If several channels are triggered, clicking button takes you to the synch playback interface. Check checkbox to select one channel for playback or select multiple channels for synchronous playback.

The maximum number of channels for synchronous playback supported varies with different models.

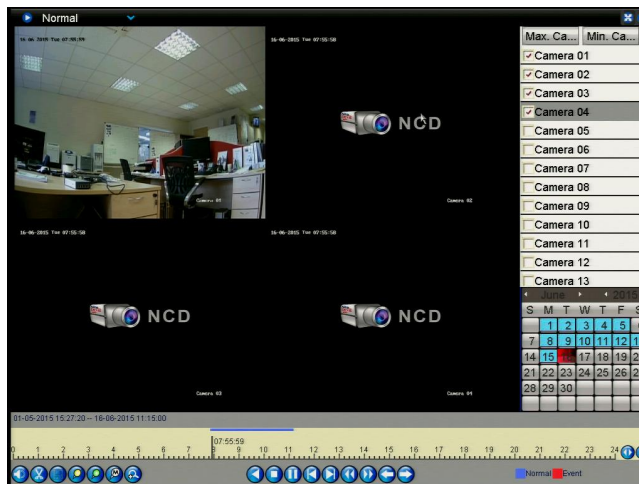

Figure 6.1.3.3 Select Channels for Synchronous Playback

6. Event playback interface.

The toolbar at the bottom of the Playback interface can be used to control playing process.

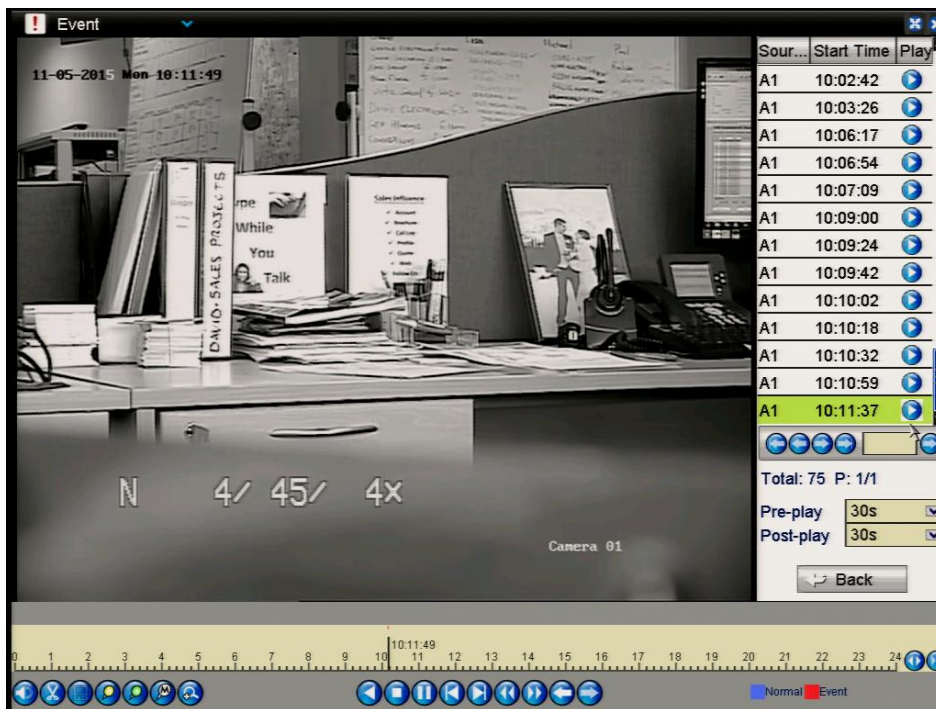

Figure 6.1.3.4 Interface for Playback by Event

Pre-play and post-play can be configured for the playback of event triggered record files.

Pre-play: The time you set to play back before the event. For example, when an alarm triggers a recording at 10:00, if you set the pre-play time to 5 seconds, the video plays back from 9:59:55.

Post-play: The time you set to play back after the event. For example, when an alarm triggering a recording, ends at 11:00, if you set the post-play time to 5 seconds, the

video will plays back until 11:00:05.



Figure 6.1.3.5 Toolbar of Playback by Event

Detailed Explanation of Playback-by-event Interface

Button	Operation	Button	Operation	Button	Operation
	Audio on /Mute		Start/Stop clipping		Save Clip(s)
	Add default tag		Add customised tag		Tag management
	Digital Zoom		30secs backwards		30 secs forwards
	Pause		Pause play/ Play/ Single-frame play		Stop
	Previous event		Next event		Full Screen
	Speed Down		Speed Up		Exit
	Process bar		Video type bar Blue Normal Red Event Recording		Time Bar Zoom In Time Bar Zoom Out

- Playback progress bar: use the mouse to click any point on the progress bar or drag the progress bar to locate special frames.
- About video type bar: ■ represents normal recording (manual or schedule);
 - ■ represents event recording; ■ represents smart search recording.

6.1.4 Playing Back by Tag

Purpose:

Video tag allows you to record related information like people and location of a certain time point during playback. You are also allowed to use video tag(s) to search for record files and position time point.

Before playing back by tag:

1. Enter Playback interface.
Menu>Playback
2. Search and playback the recorded file(s). Refer to *Chapter 6.1.1 Playing Back by Channel* for the detailed information about searching and playing back the recorded files. Note must be in Normal Mode at this point. Now start playback.

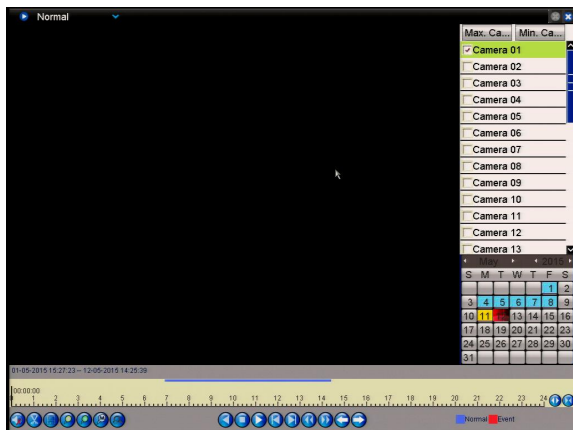

Figure 6.1.4.1 Normal Playback Interface

- Click button to add default tag.
 - Click button to add customised tag and input tag name.
- Max. 64 tags can be added to a single video file.

3. Tag management.

Click button to check, edit and delete tag(s).

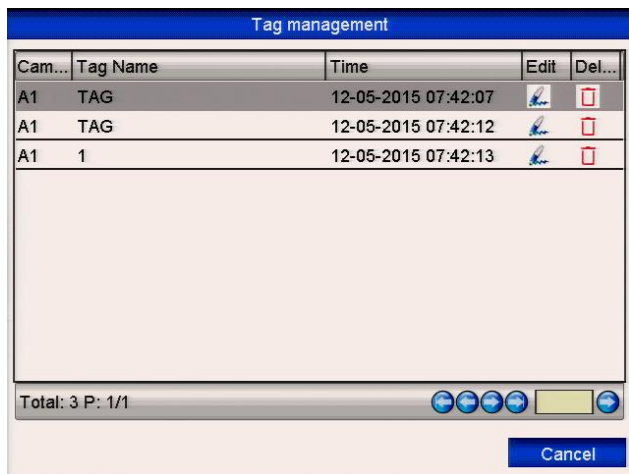
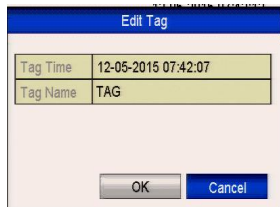

Figure 6.1.4.2 Tag Management Interface

Steps:

1. Select the **Tag** from the drop-down list in the Playback interface.
2. Choose channels, edit start time and end time, and then click Search to enter Search Result interface.



You can enter keyword in the textbox

Keyword

to search the tag in your command. See below.

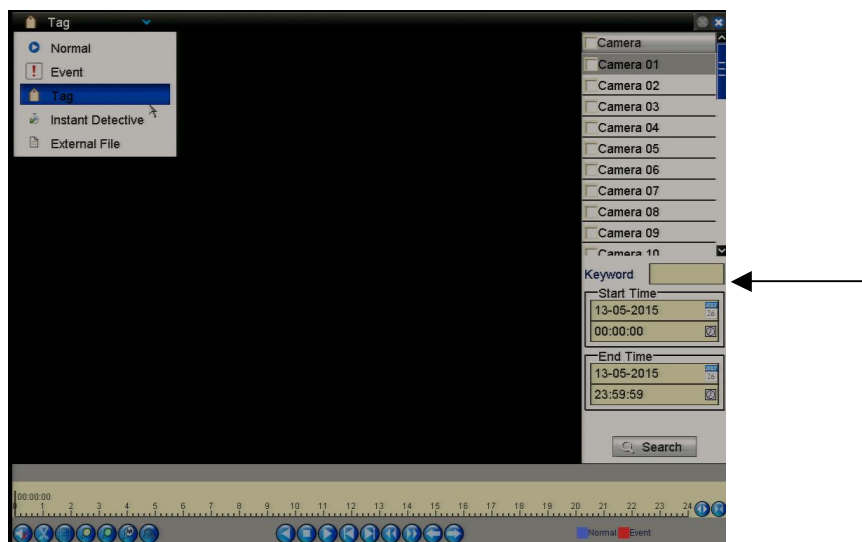



Figure 6.1.4.3 Video Search by Tag

3. Click  button to play back the file.

You can click the **Back** button to return to the search interface.

Pre-play and post-play can be configured.

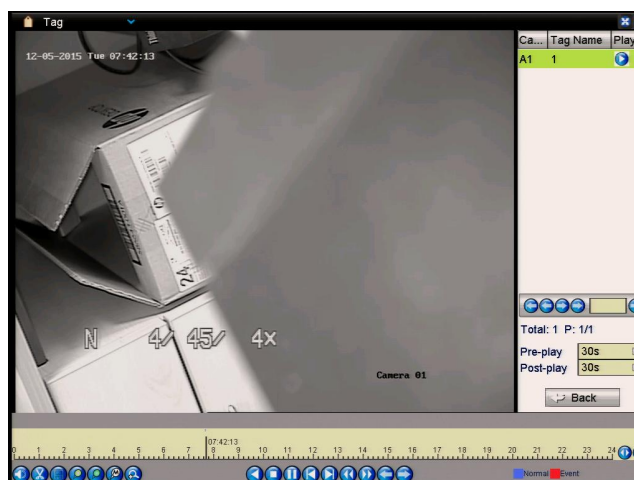

Figure 6.1.4.4 Playback by Tag Interface



Figure 6.1.4.5 Playback by Tag Toolbar

Detailed Explanation of Playback-by-tag Toolbar

Button	Operation	Button	Operation	Button	Operation
	Audio on /Mute		Start/Stop clipping		Save Clip(s)
	Add default tag		Add customised tag		Tag management
	Digital Zoom		30secs backwards		30 secs forwards
	Pause/Play/ Play Reverse		Tag Playback		Stop
	Previous Tag		Next Tag		Full Screen
	Slow forward		Fast forward		Exit
	Process bar		Video type bar		Time Bar In/Out

- (blue) represents normal recording (manual or schedule); (red) represents event recording (motion, alarm, motion | alarm, motion & alarm).
- Playback progress bar: use the mouse to click any point on the progress bar to locate required recorded picture frames.

6.1.5 Playing Back by Instant Detective

Purpose:

The Instant Detective playback function provides an easy way to get through the less effective information. When you select the Instant Detective playback mode, the system will analyse the video containing motion or VCA information, and mark it with a green colour on the playback process bar. The filtering rules for recorded files and playback speed for the non-related and related video, can be configured independently.

The playback by Instant Detective search is not supported for IP cameras.

Steps:

1. Enter the Instant Detective Playback interface.
2. Select a camera from the camera list, then the date in the calendar and then click the button to play.
3. Click the on the toolbar to enter Instant Detective Search mode. The smart search toolbar appears at the bottom of the screen.

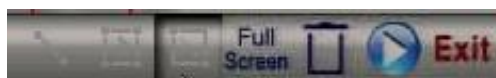
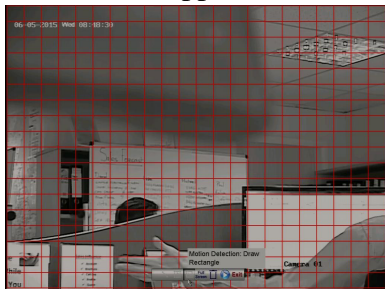









Figure 6.1.5.1 Draw Area for Smart Search

4. Click and drag the mouse to draw area(s) for Instant Detective search, VCA event or motion event.
 - **Line Crossing Detection**
Click the  button, and click on the video display screen to specify the start point and end point of the line.
 - **Intrusion Detection**
Click the  button, and specify 4 points to set a quadrilateral region for intrusion detection. Only one region can be set.
 - **Motion Detection**
Click the  button and using the mouse set the detection area manually. You can also click the **Full Screen** button to set the full screen as the detection area.
5. Click the  to search and then the result will be displayed as  on the progress bar in the Instant Detective Playback interface.
Alternatively you can click the  button to clear all the set areas.
6. Click the  button to play

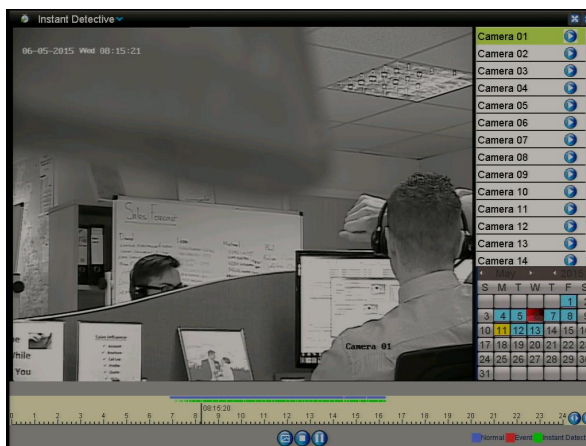







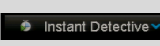

Figure 6.1.5.2 Smart Playback Interface

- Playback progress bar: use the mouse to click any point of the progress bar or drag the progress bar to locate special frames.
- About video type bar:  (Blue) represents normal recording (manual or schedule);  (Red) represents event recording;  (Green) represents Instant Detective recording.

Detailed Explanation of Instant Detective Playback

Button	Operation	Button	Operation	Button	Operation
	Smart search		Stop		Pause play/ Play
	Process bar		Scaling up/down the time line		Video type / picture

6.1.6 Playing Back by System Logs

Purpose:

Play back record file(s) associated with channels after searching system logs.

Steps:

1. Enter Log Information interface.
Menu>Tools>Log Information

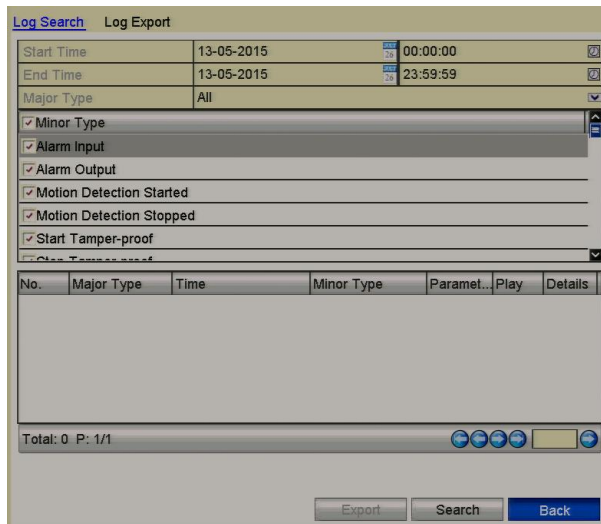

Figure 6.1.6.1 System Log Search Interface

2. Click **Log Search** tab to enter Playback by System Logs.
Set search time and type then click **Search** button.

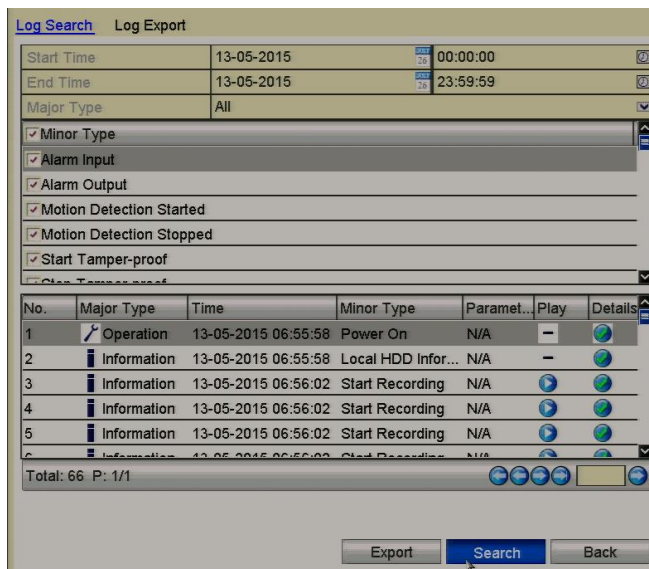



Figure 6.1.6.2 Result of System Log Search

3. Choose a log with recorded file and click  button to enter Playback interface. If there is no record file at the time point of the log, the message box “No result found” will be displayed.

4. Playback management.

The toolbar in the bottom part of Playback interface can be used to control playing process.

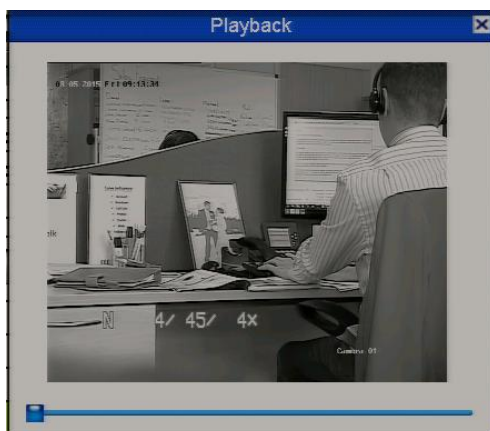



Figure 6.1.6.3 Interface of Playback by Log

6.1.7 Playing Back External File

Purpose:

Perform the following steps to look up and play back files on external devices. Note that playback will only work with this DVR's supported camera formats.

Steps:

1. Enter the Playback Search interface.
Menu>Playback
2. Select the **External File** in the drop-down list on the top-left side.
The files are listed on the righthand side of the screen.
You can click the  Refresh button to refresh the file list.
3. Select and click the  button to start playback.

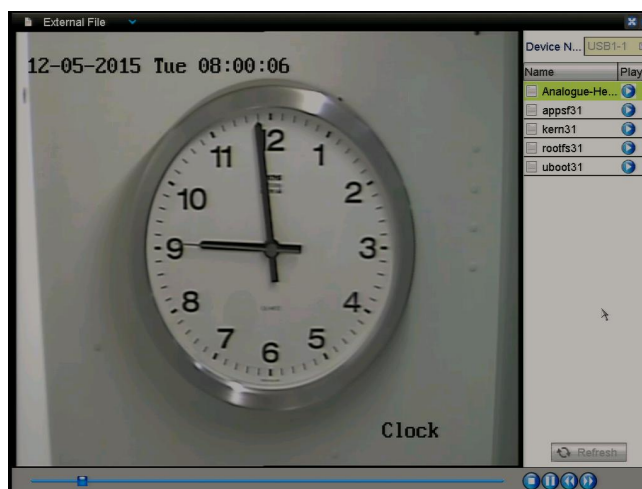

Figure 6.1.7.1 Interface of External File Playback

6.2 Auxiliary Functions of Playback



6.2.1 Playing Back Frame by Frame

Purpose:



Playback video files frame by frame, in order to check image details of the video when abnormal events happen.

Steps:

- **Using a Mouse**

Go to Playback interface and click button  until the speed changes to *Single* frame. One click on the playback screen represents playback or reverse playback of one frame. It is also feasible to use the pause button  in toolbar.

- **Using the front panel (Some DVRs will not support this function)**

Press the  button to set the speed to *Single* frame. One click on the playback screen or press  button on the front panel represents playback or reverse playback of one frame.

6.2.2 Digital Zoom

Steps:

1. Click the  button on the playback control bar to enter Digital Zoom interface.
2. Use the mouse to draw a red rectangle and the image within it will be enlarged up to 16 times.

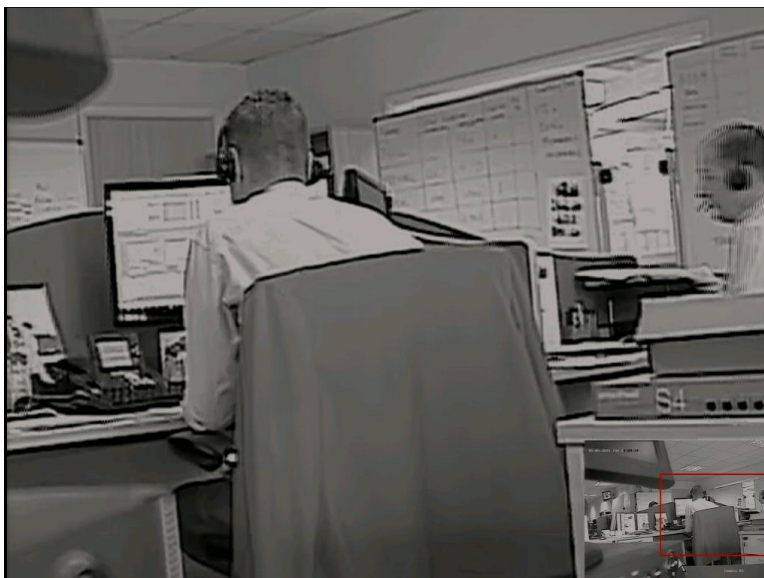

Figure 6.2.2.1 Draw Area for Digital Zoom

3. Right-click the image to exit the digital zoom interface.

6.2.3 Reverse Playback of Multi-channel

Purpose:

You can playback multi-channel recorded files in reverse mode. Up to 16-ch (with 1920*1080 resolution) simultaneous reverse playback is supported.

Steps:

1. Enter Playback interface.
Menu>Playback
2. Check more than one checkbox to select multiple channels and click to select a date on the calendar.



Figure 6.2.3.1 4-ch Synchronous Playback Interface

3. Click  to play back the record files in reverse.

Chapter 7 Backup

7.1 Backing up Record Files

Before you start:

Please insert the backup device(s) in the dvr.

7.1.1 Backing up by Normal Video Search

Purpose:

The recorded files can be backed up to various USB devices, such as USB flash drives, USB HDDs and USB writer.

Backup using USB flash drives, USB HDDs, and USB writer

Steps:

1. Enter Export interface.
Menu>Backup>Normal

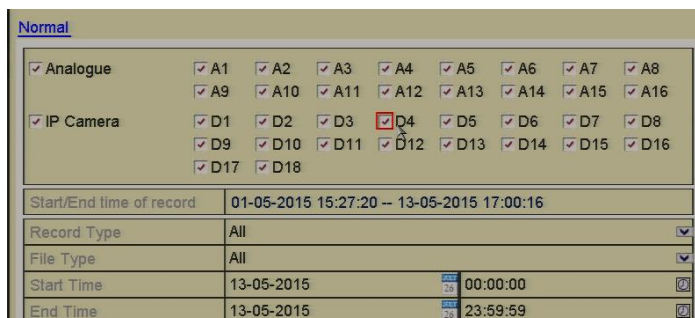

Figure 7.1.1.1 Normal Export Interface

2. Set search condition and click **Search** button to enter the search result interface.

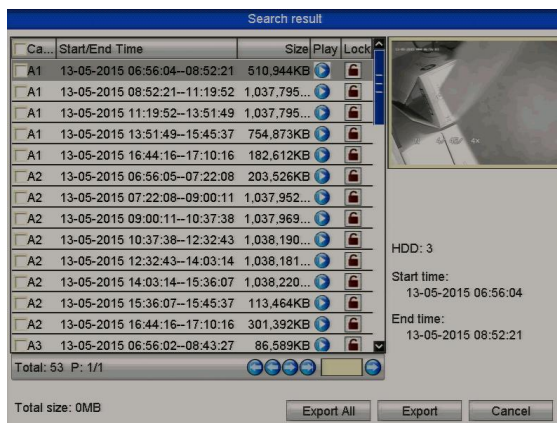



Figure 7.1.1.2 Result of Normal Video Search for Backup

3. Select record files you want to back up.
Click button  to play the recorded file if you want to check it.
Click the checkbox for the recorded files you want to back up. The size of the currently selected files is displayed in the lower-left corner of the window.

Export

Click **Export** button and start backup.

If the inserted USB device is not recognised:

- Click the **Refresh** button.
- Reconnect device.
- Check for compatibility from vendor.

You can also format the USB device by clicking the **Format** button.

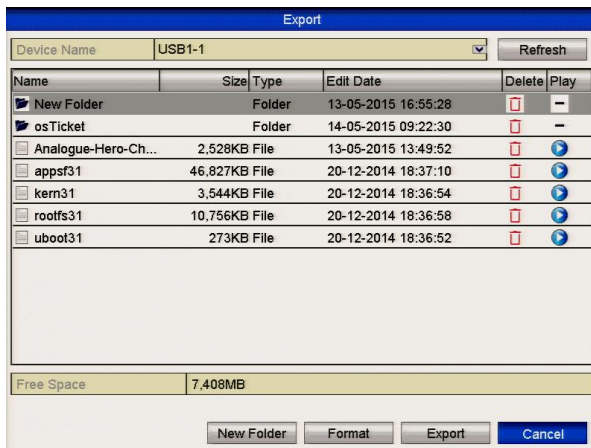

Figure 7.1.1.3 Export by Normal Video Search using USB Flash Drive

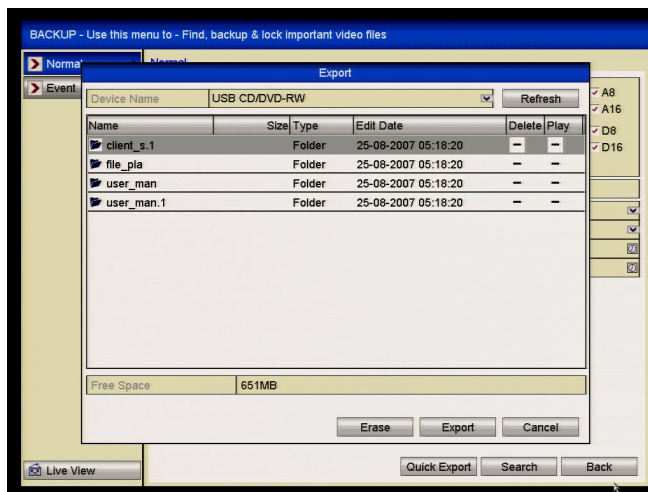

Figure 7.1.1.4 Export by Normal Video Search using USB Writer

Stay in the Exporting interface until all recorded files are exported with display message box “Export finished”.

4. Check backup result.

Choose the recorded file in Export interface and click button to check it.

The Player player.exe will be exported automatically during record file export.

Backup using eSATA HDDs

This function is supported by MAX316 and MAX416 only.

Steps:

1. Enter Drives menu and set the usage of eSATA HDD to “Export”.

Menu>Drives>eSATA

Choose eSATA and set its usage to Export. Click **Yes** when message “System will reboot automatically if the usage of eSATA is changed. Continue?” displays. The eSATA HDD allows for Record and Export functions. Changes in usage will only take effect after rebooting the device.

2. Enter Backup interface.

Menu>Backup>Normal

Set search condition and click **Search** button to enter the search result interface.

3. Select record files you want to back up.

Click button  to play the recorded file if you want to check it.

Tick record files you want to backup.

The size of the currently selected files is displayed in the lower-left corner of the window.

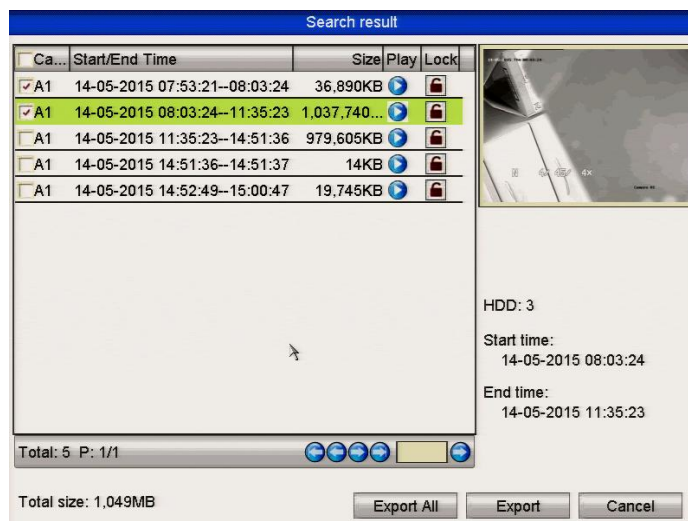

Figure 7.1.1.5 Result of Normal Video Search for Backup

4. Export.

Click **Export** button and start backup.

- Please format the eSATA drive before using it for the first time.
- If the inserted eSATA HDD is not recognised:
 - Click the **Refresh** button.
 - Reconnect device.
 - Check for compatibility from vendor.

You can also format eSATA HDD via the device.

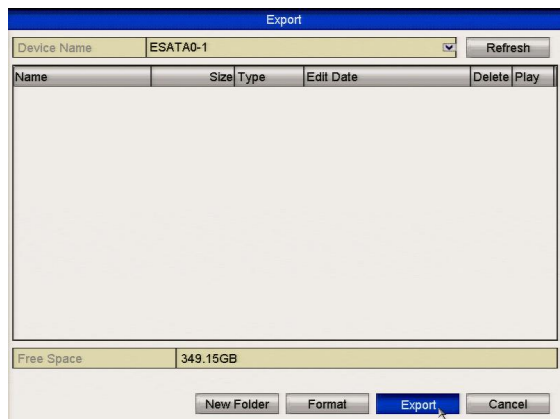



Figure 7.1.1.6 Export by Normal Video Search Using eSATA HDD

Stay in the Exporting interface until all recorded files are exported with display message “Export finished”.

5. Check backup result.

Choose the recorded file in Export interface and click button  to check it. The player.exe program will also be exported automatically during the export if selected.

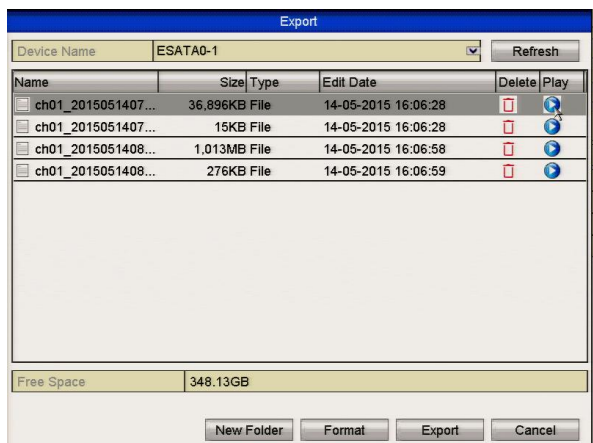

Figure 7.1.1.7 Checkup of Export Result Using eSATA HDD

7.1.2 Backing up by Event Search

Purpose:

Back up event-related recording files using USB devices, such as USB flash drives, USB HDDs, and USB writer.

Steps:

1. Enter Export interface.
Menu>Backup>Event
2. Search for events.
 - 1) Select **Motion, Alarm Input, Line Crossing Detection** or **Intrusion Detection** as the type.
 - Here we take the backup by motion detection as an example.
 - Backup by alarm input is not supported on some models.

- 2) Tick the checkbox of cameras and set the search time.
- 3) Click **Search** button to enter the Search Result interface.

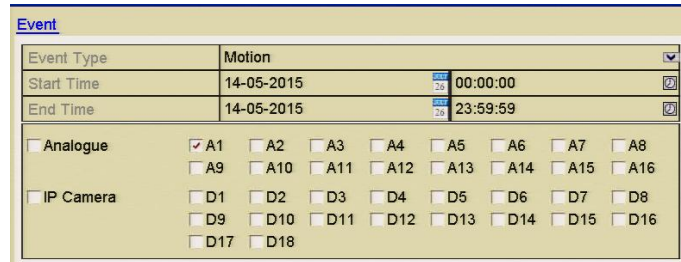

Figure 7.1.2.1 Event Search for Backup

3. Select recorded files for export

- 1) Select an alarm input in the list and click **Quick Export** button to enter Export interface.
- 2) Clicking **Details** button will take you to the interface with detailed information of all channels triggered by the event.

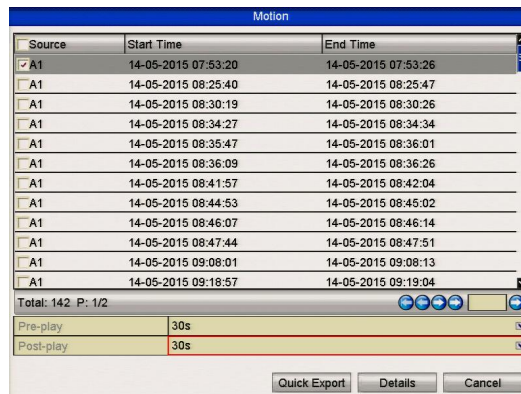

Figure 7.1.2.2. Result of Event Search

- 3) Click **Details** button to view detailed information of the record file, e.g. start time, end time, file size, etc.

The size of the currently selected files is displayed in the lower-right corner of the window.

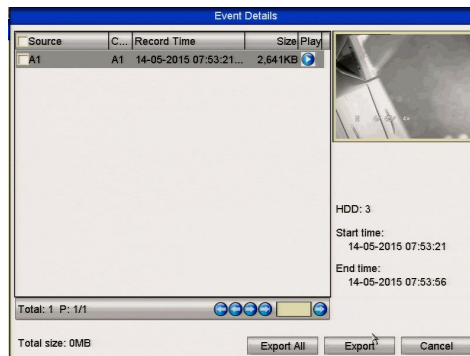

Figure 7.1.2.3 Event Details Interface

4. Export.

Click the **Export** button and start backup.

If the inserted USB device is not recognized:

- Click the Refresh button.
- Reconnect device.
- Check for compatibility from vendor.

You can also format USB flash drive or USB HDDs via the device.

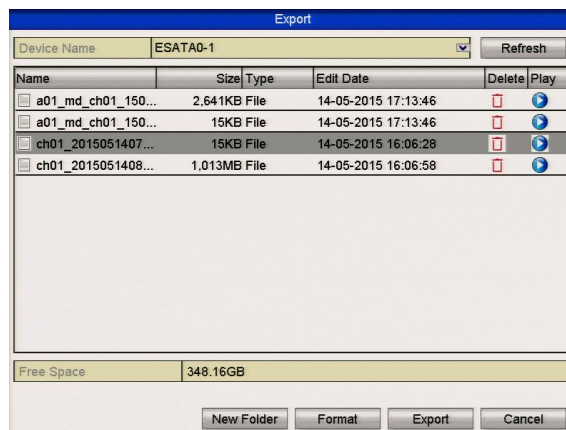

Figure 7.1.2.4 Export by Event Using USB Drive

Stay in the Exporting interface until all record files are exported with display message “Export finished”.

5. Check backup result by clicking Blue Play button

The Player player.exe will be exported automatically during record file export.

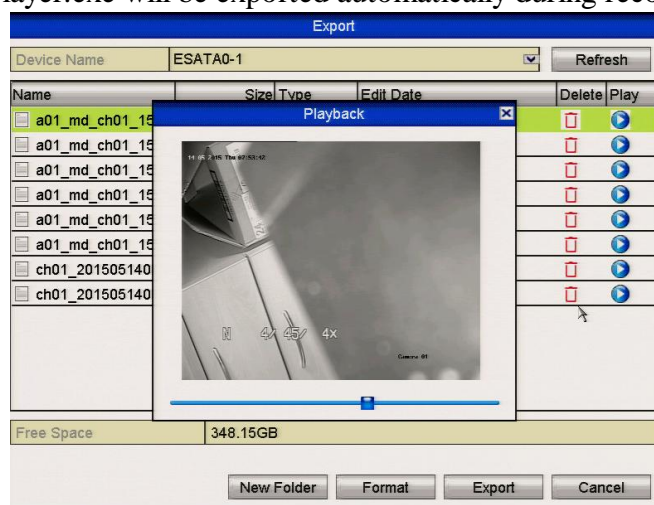

Figure 7.1.2.5 Checkup of Event Export Result using USB Drive

7.1.3 Backing up Video Clips

Purpose:

You may also select video clips to export directly during Playback, using USB devices, such as USB flash drives, USB HDDs, and USB writers.

Steps:

1. Enter Playback interface.
Please refer to *Chapter 6 Playback*.

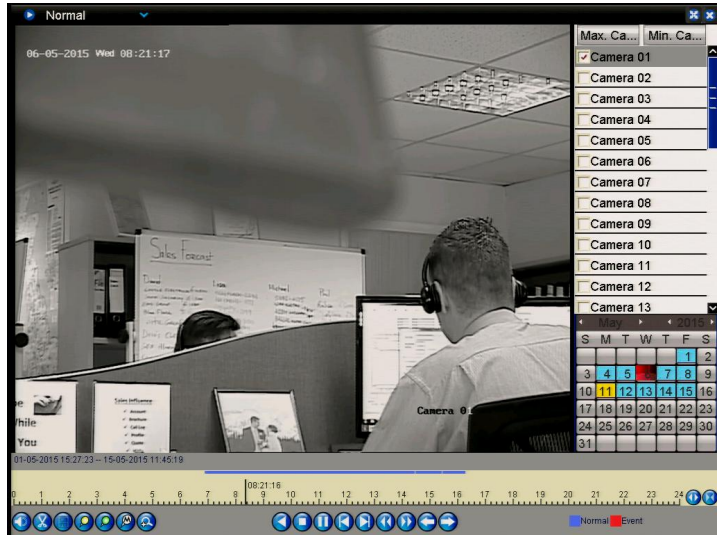





Figure 7.1.3.1 Interface of Playback

2. During playback, use buttons  and  in the playback toolbar to start and stop the file clipping option.
3. Right click the mouse and click the icon  to enter the Clip Export interface.

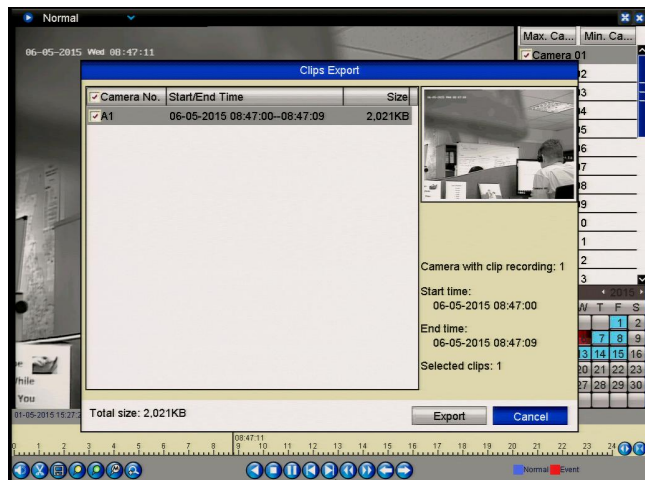

Figure 7.1.3.2 Clip Export

4. Click the button **Export** to export the selected video clips to the backup device.

If the inserted USB device is not recognised:

- Click the **Refresh** button.
- Reconnect device.
- Check for compatibility from vendor.

You can also format USB devices by clicking the **Format** button.

Up to 30 items of video clips can be selected for backup at one time.

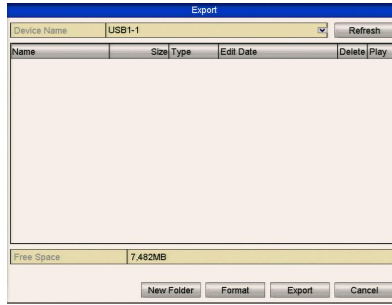
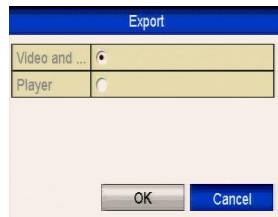
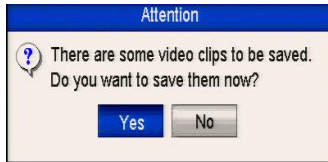

Figure 7.1.3.3 Export Video Clips Using USB Flash Drive

Stay in the Exporting interface until all recorded files have been exported with “Export finished” message displayed.

5. If there are clips not saved a prompt will display when you quit the Playback interface.



Figures 7.1.3.4a Saving Video Clips 7.1.3.4b Select Video & Player or Player*

6. Click **Yes** to save video clips and enter Export interface or click **No** to quit without saving video clips.

7. Check backup result. The player.exe will be exported automatically during recorded file export. *Note some models allow separate Player backup.

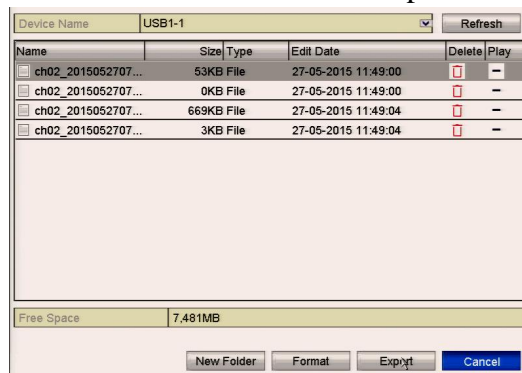

Figure 7.1.3.5 Checkup of Video Clips Export Result Using USB Flash Drive

7.2 Managing Backup Devices

Steps:

1. Enter Search Result interface for recorded files.

Menu>Back Up>Normal

Set search condition and click **Search** button to enter Search Result interface.

At least one channel must be selected.

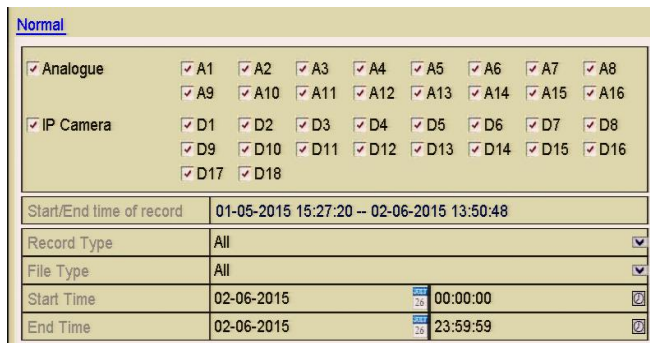

Figure 7.2.1 Normal Video Search for Backup

2. Select the recorded files you want to backup.

At least one file must be selected.

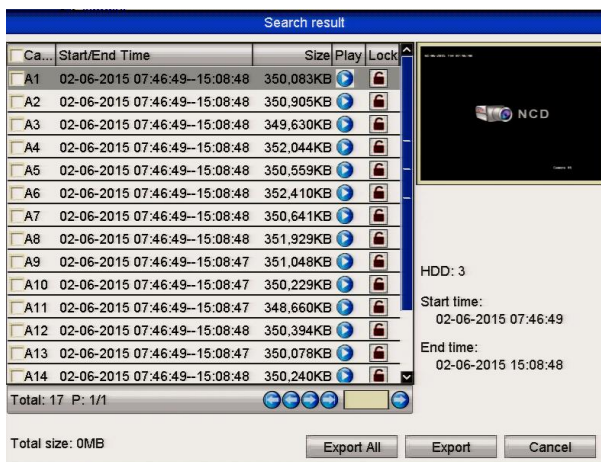

Figure 7.2.2 Backup Results for Normal Video Search

If you select **Quick Backup** the Search Results page above is ignored.

3. Backup device management.

➤ **Management of USB flash drives, USB HDDs and eSATA HDDs**

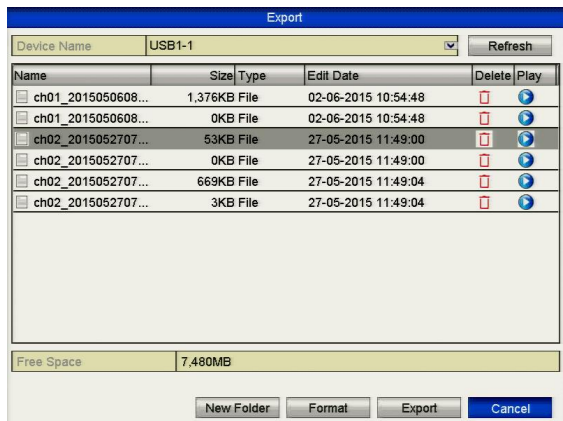



Figure 7.2.3 USB Flash Drive Management

Click **New Folder** button if you want to create a new folder in the backup device. Select a recorded file or folder in the backup device and press button

 if you want to delete it. Select a recorded file in the backup device and press button  to play it.

Click **Format** button to format the backup device.

If the inserted USB device is not recognised:

- Click the **Refresh** button.
- Reconnect device.
-
- Check for compatibility from vendor.

➤ **Management of USB writers**



Figure 7.2.4 USB Writer Management

Click **Delete** button if you want to delete the files from a re-writable CD/DVD.

- There must be a re-writable CD/DVD installed.
- If the inserted USB writer is not recognised:
 - Click the **Refresh** button.
 - Reconnect device.
 - Check for compatibility from vendor.

Chapter 8 Alarm Settings

8.1 Setting Motion Detection Triggering

There are two stages in motion detection setup. Stage 1 for motion triggering is detailed below. Motion recording, Stage 2 is covered in the Schedule menu.

Steps:

1. Enter Motion Detection interface in Camera Management and choose a camera you want to set up for motion detection.

Menu> Video> Motion

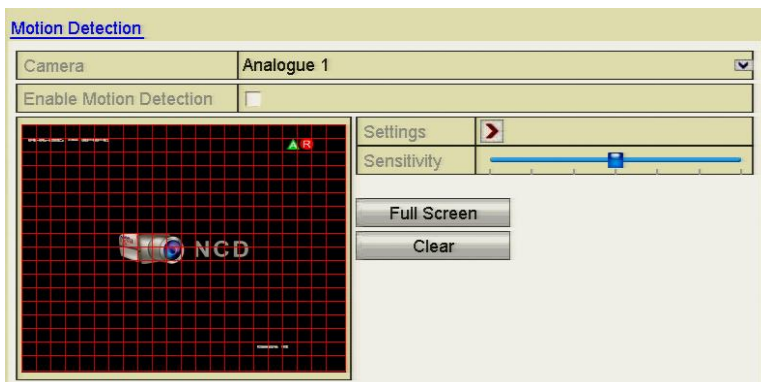

Figure 8.1.1 Motion Detection Setup Interface

2. Set detection area and sensitivity.

Click checkbox to enable motion detection and use the mouse to draw detection area(s) then drag the sensitivity bar to set sensitivity.

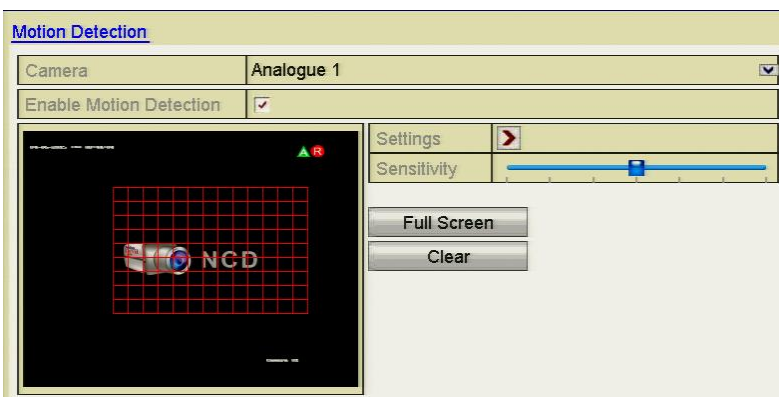



Figure 8.1.2 Set Detection Area and Sensitivity

3. Click Settings  to set alarm response actions.

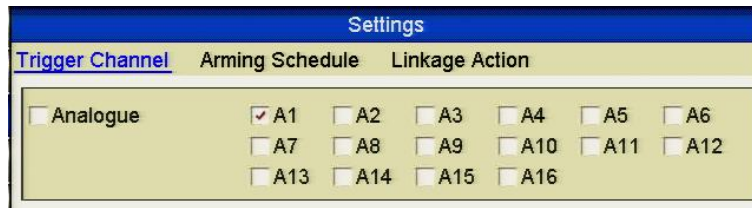

Figure 8.1.3 Set Trigger Camera of Motion Detection

Click **Trigger Channel** tab and select one or more channels which will start to record or become full-screen monitoring when motion alarm is triggered.

4. Set arming schedule of the channel.

Select **Arming Schedule** tab to set the channel's arming schedule.

Choose one day of a week and up to eight time periods can be set within each day.

You can click the **Copy** button to copy the time period settings to other day(s).

Time periods must not be duplicated or overlap.

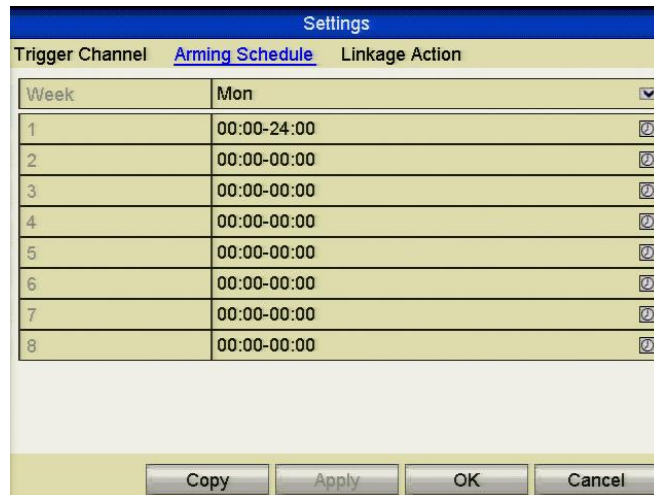

Figure 8.1.4 Set Arming Schedule of Motion Detection

5. Click **Linkage Action** tab to set up alarm response actions for motion alarm (please refer to *Setting Alarm Response Actions* in this Chapter.

Repeat the above steps to set up arming schedule for other days of the week.

Click the **OK** button to complete the motion detection settings for the channel.

6. If you want to set motion detection for another channel, repeat the above steps or just copy the above settings to it.

You are not allowed to copy the "Trigger Channel" action.

8.2 Setting Sensor Alarms

This function may not be supported on some DVR models.

Purpose:

Set up handling method of an external sensor alarm.

Steps:

1. Enter Alarm Settings in System Configuration and select an alarm input.

Menu> Setup> Alarm

Select Alarm Input tab to enter Alarm Input Settings interface.

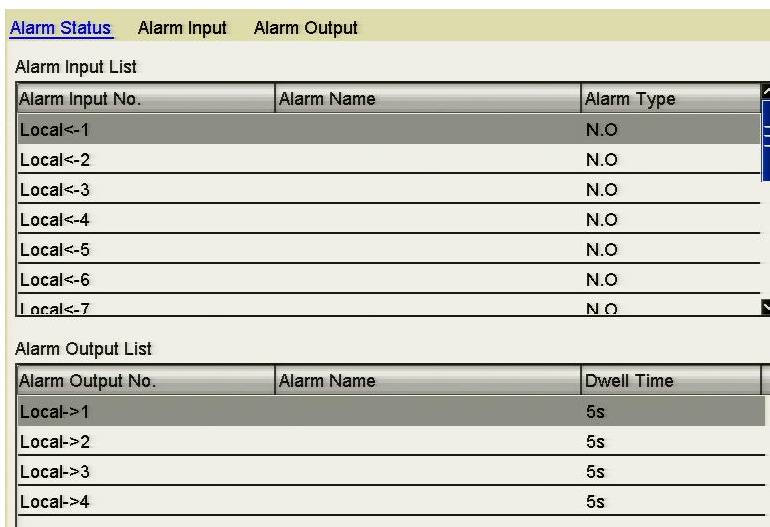

Figure 8.2.1 Alarm Status Interface

2. Set the handling method of the selected alarm input.

Click the **Enable** checkbox and  button to set alarm response actions.

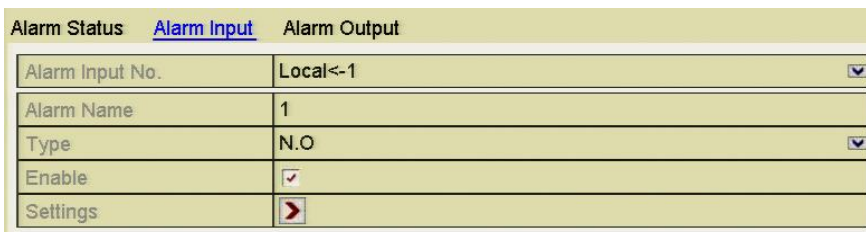

Figure 8.2.2 Alarm Input Settings Interface

3. Select Trigger Channel tab and select one or more channels which will start to record and initiate full-screen monitoring when an external alarm input is triggered.
4. Select **Arming Schedule** tab to set the channel's arming schedule. Choose one day of a week and a maximum of eight time periods can be set within each day. Time periods must not be duplicated or overlap.

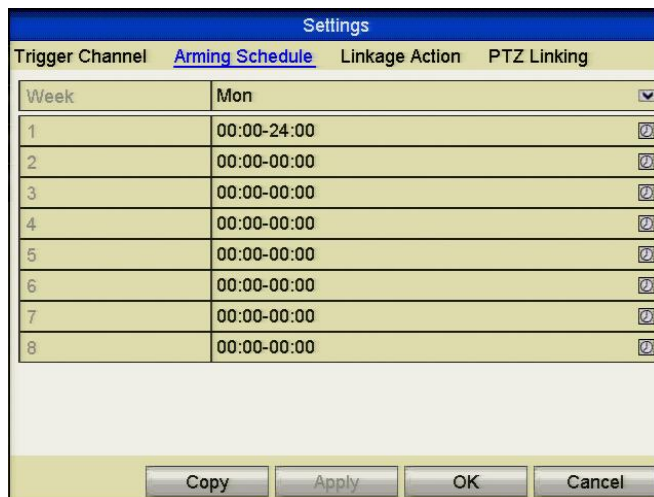

Figure 8.2.3 Set Arming Schedule of Alarm Input

5. Select **Linkage Action** tab to set up alarm response actions of the alarm input (please refer to *Setting Alarm Response Actions later in this chapter.*
Repeat the above steps to set up arming schedule of other days of a week. You can also use **Copy** button to copy an arming schedule to other days.
6. If necessary, select **PTZ Linking** tab and set PTZ linkage for the alarm input. Set PTZ linking parameters and click the **OK** button to complete the alarm input settings.

Please check whether the PTZ or speed dome supports PTZ linkage.
One alarm input can trigger presets, patrols or patterns for more than one channel.
However presets, patrols and patterns are exclusive.

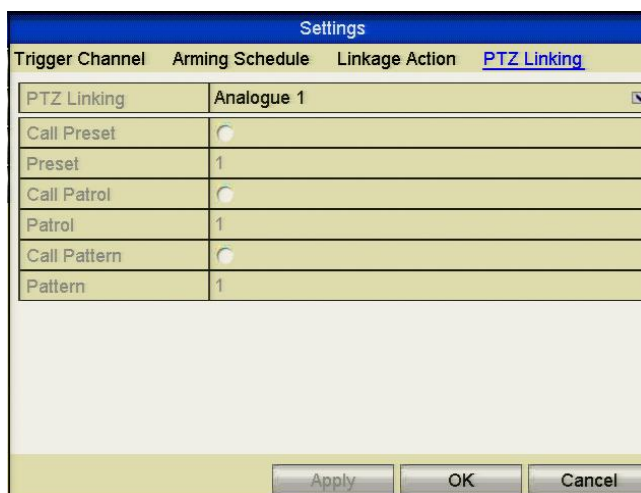

Figure 8.2.4 Set PTZ Linking of Alarm Input

7. If you want to set handling action of another alarm input, repeat the above steps or just copy the above settings to it.

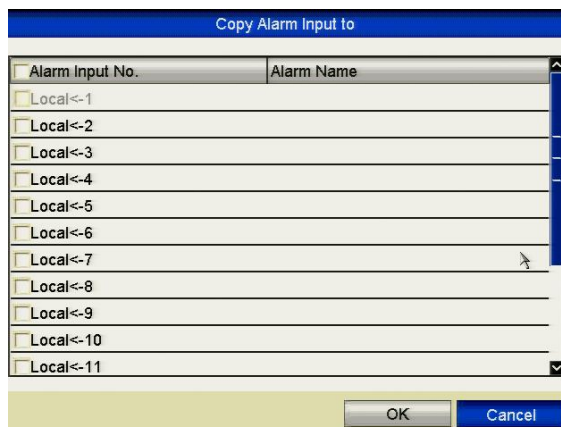

Figure 8.2.5 Copy Settings of Alarm Input

8.3 Detecting Video Loss

Purpose:

Detect video loss of a channel and take alarm response action(s).

Steps:

1. Enter Video Loss interface in Camera Management and select a channel you want to detect.

Menu> Video> Video Loss

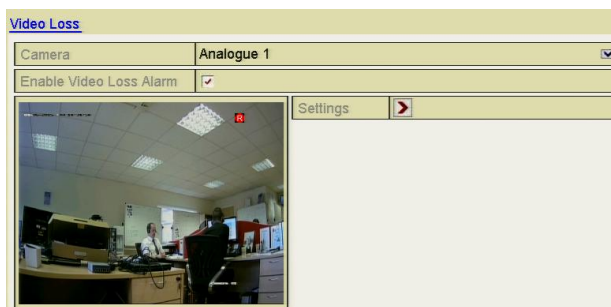

Figure 8.3.1 Video Loss Setup Interface

2. Set up handling method for video loss.
 - Click the checkbox “Enable Video Loss Alarm”.
 - Click **Settings** button to set up handling method of video loss.
3. Set arming schedule for the channel.
 - Select **Arming Schedule** tab to set the channel’s arming schedule.
 - Choose one day of a week and up to eight time periods can be set within each day.
 - You can click the **Copy** button to copy the time period settings to other day(s).
 - Time periods must not be duplicated or overlap.

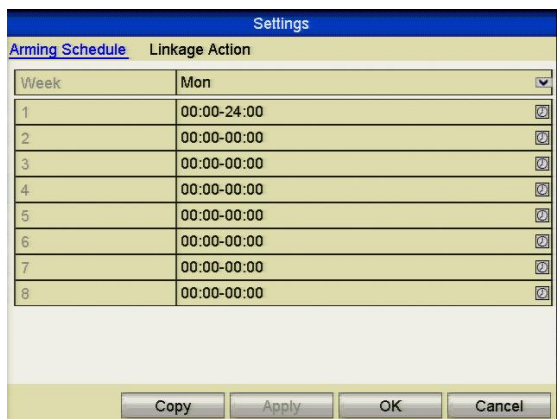

Figure 8.3.2 Set Arming Schedule of Video Loss

Repeat the above steps to set arming schedule of other days of a week. You can also use **Copy** button to copy an arming schedule to other days.

4. Select **Linkage Action** tab to set up alarm response action of video loss (please refer to *Setting Alarm Response Actions* later in this chapter).
5. Click the **OK** button to complete the video loss settings for the channel. Repeat the above steps to finish settings of other channels, or click the **Copy** button to copy the above settings to them.

8.4 Detecting Video Tampering

Purpose:

Trigger alarm when the lens is covered and take alarm response action(s).

Steps:

1. Enter Video Tampering interface in Camera Management and select a channel you want to detect for video tampering.
Menu> Video> Tamper-proof

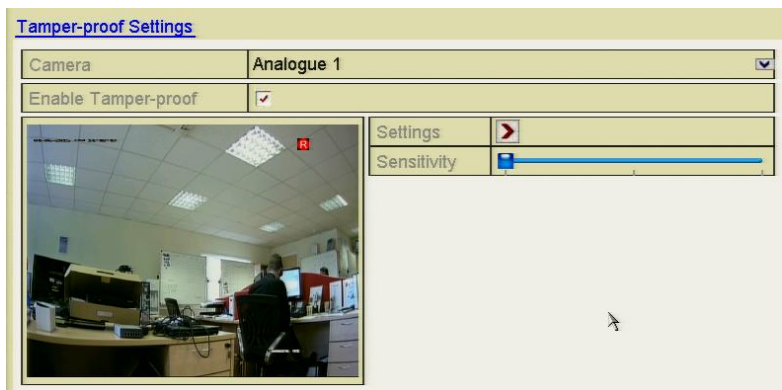

Figure 8.4.1 Video Tampering Interface

2. Click the checkbox “Enable Tamper-proof”.
3. Drag the sensitivity bar and choose the required sensitivity level.
4. Click **Settings** to set handling method for video tampering. Set arming schedule and alarm response actions for the channel.
 - 1) Click **Arming Schedule** tab to set the arming schedule response action.
 - 2) Choose one day of the week and up to eight time periods can be set within each day. Time periods must not be duplicated or overlap.

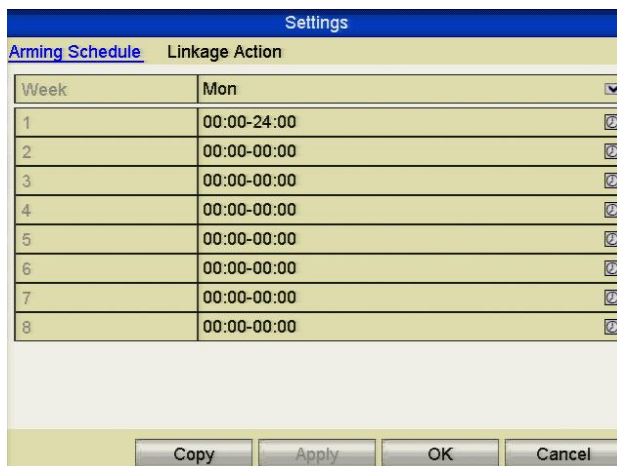

Figure 8.4.2 Set Arming Schedule for Video Tampering

- 3) Select **Linkage Action** tab to set alarm response actions for video tampering alarm (please refer to *Setting Alarm Response Actions* later in this chapter. Repeat the above steps to set arming schedule for other days of the week. You can also use **Copy** button to copy an arming schedule for other days.
 - 4) Click the **OK** button to complete the video tampering settings for the channel. Repeat the above steps to finish settings for other channels, or click the **Copy** button copy the above settings to them.
5. Click the **Apply** button to save and activate the settings.

8.5 Detecting VCA Alarm

Purpose:

The DVR can provide VCA (Video Content Analysis) capability for enabling linkage actions when detecting exceptional events such as people, vehicles and objects crossing a virtual line or intruders entering a pre-defined region.

The MEGA series DVRs can receive the VCA alarm sent by analogue cameras but VCA detection must be enabled and configured in the VCA settings interface first.

Perform the steps below to set the VCA configuration.

The MEGA204, MEGA208, MEG216 and MAX316 support one analogue camera channel for VCA but 2 analogue camera channels for the MAX416.

Steps:

1. Enter VCA Alarm interface in Camera Management and select a camera you want to detect the VCA alarm.

Menu> Video> VCA

REMINDER: The selected camera must support the VCA function.

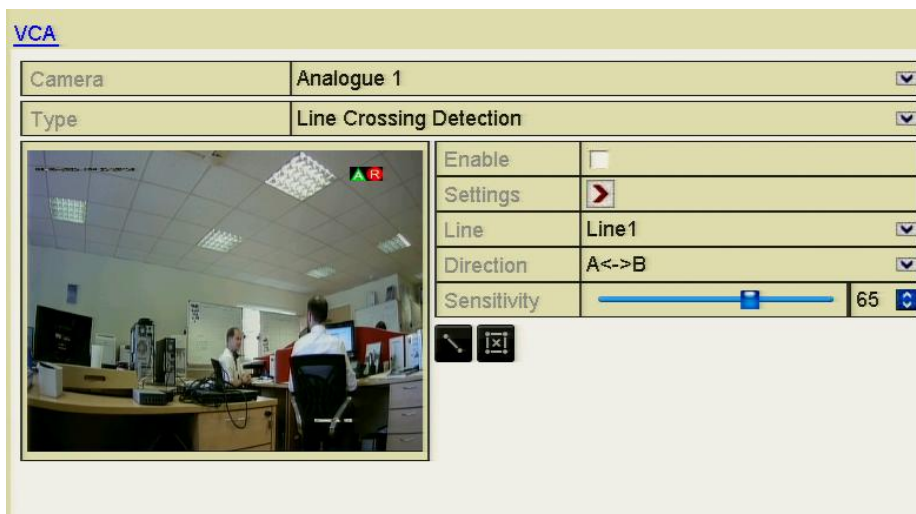



Figure 8.5.1 VCA Alarm Setting Interface

2. Select the analogue camera to configure the VCA.
3. Select the detection type to **Line Crossing Detection** or **Intrusion Detection**.

Line Crossing Detection: This function can be used for detecting people, vehicles and objects crossing a set virtual line. The line crossing direction can be set as bidirectional, from left to right or from right to left or you can set the duration for the alarm response actions, such as full screen monitoring, audible warning, etc.

Intrusion Detection: This function can be used for detecting whether there are people, vehicles and objects intruding into the pre-defined region longer than the set duration. You can set the duration for the alarm response actions, such as full screen monitoring, audible warning.

4. Click the **Enable** checkbox to enable the selected VCA detection.
5. Click the **Settings**  to configure the trigger channel, arming schedule and linkage actions.

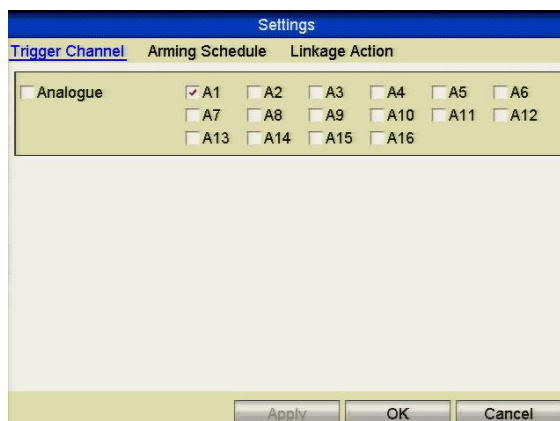

Figure 8.5.2 Set Triggering Channel for VCA Alarm

- 1) Select **Trigger Channel** tab and select one or more channels which will start to record/capture or become full-screen monitoring when a VCA alarm is triggered, and click **Apply** to save the settings.
- 2) Select **Arming Schedule** tab to set the arming schedule for handling actions.

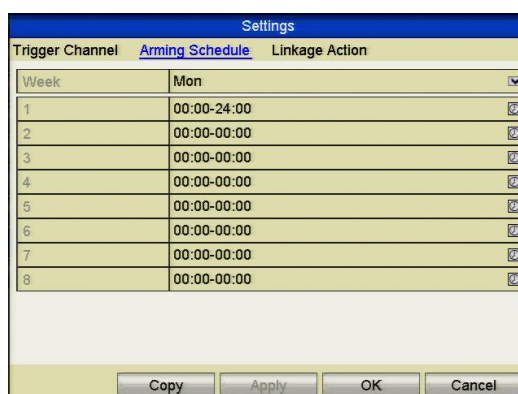

Figure 8.5.3 Set Arming Schedule for VCA Alarm

Choose one day of the week and up to 8 time periods can be set within each day. Click **Apply** to save the settings. Time periods must not be duplicated or overlap.

Repeat the above steps to set up arming schedule for other days of a the week. You can also use the **Copy** button to copy an arming schedule to other days.

- 3) Select **Linkage Action** tab to set up alarm response actions of the alarm input (please refer to *Setting Alarm Response Actions later in this chapter*).
- 4) Click the **OK** button to complete the VCA alarm settings for the channel.

6. Configure the region and other settings for the selected VCA detection.

Task1: Configure the Line Crossing Detection.

- 1) Select the virtual line from the drop-down list. Up to 4 lines are selectable.
- 2) Select the direction to A<->B, A->B or A<-B.

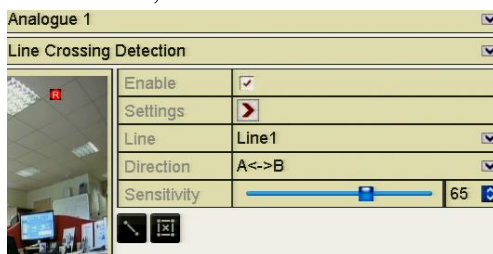



Figure 8.5.4 Set Direction of Line Crossing Detection

- 3) Set the sensitivity of the line crossing detection between 1-100.
- 4) Click  and set two points in the preview window to draw a virtual line.

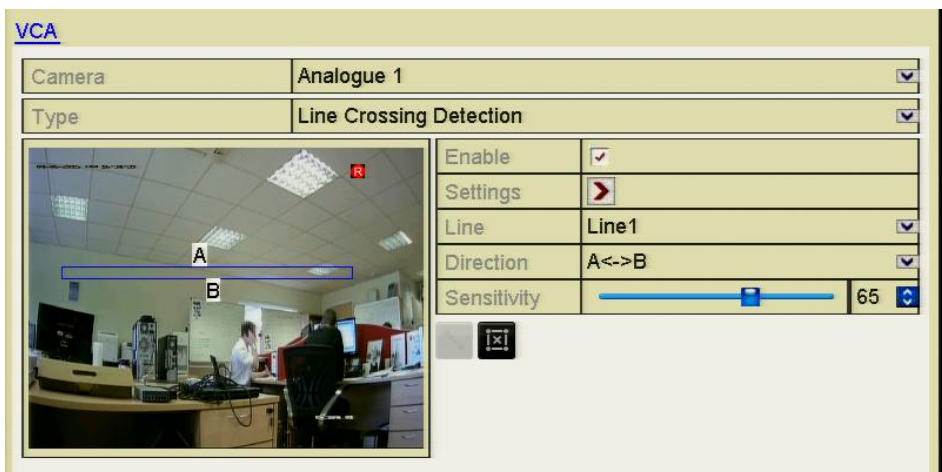



Figure 8.5.5 Draw Virtual Line in the Image

You can use the  to clear the existing virtual line and re-draw it.

- 5) Click **Apply** to save the settings.

Task2: Configure the Intrusion Detection.

- 1) Select the intrusion region from the drop-down list. Up to 4 regions are selectable.
- 2) Select the sensitivity of the intrusion detection from 1-100.
- 3) Set the percentage from 1-100. Percentage defines the ratio of the in-region part of the object which can trigger the alarm. For example, when you set the percentage to 50%, half of the object entering the region will trigger the alarm.

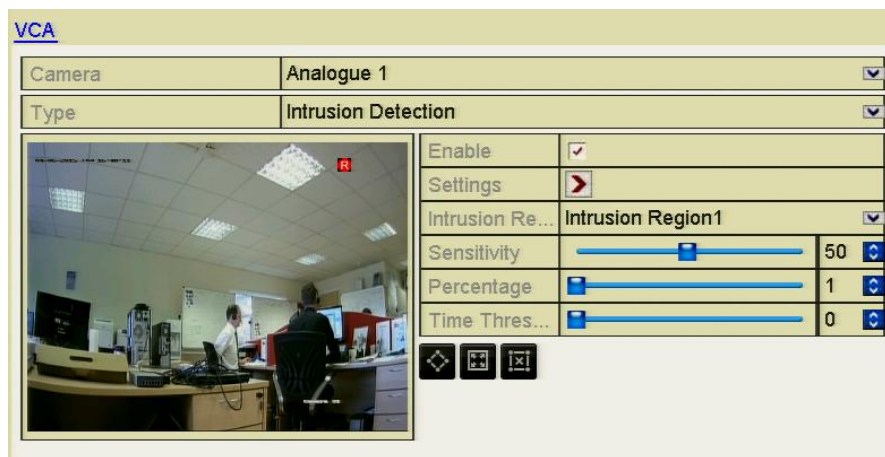





Figure 8.5.6 Set Intrusion Detection

- 4) Set the time threshold from 0-10 sec. When the duration of the object in the defined detection area is greater than the set time, the alarm will be triggered.
- 5) Click  and draw a quadrilateral or click  to draw the full screen in the preview window for the selected intrusion region. You can use the  to clear the existing region and re-draw it.
- 6) Repeat the above steps to set other intrusion regions.
- 7) Click **Apply** to save the settings.

8.6 Setting All-day Video Quality Diagnostics**Purpose:**

The device provides two ways to diagnose the video quality: manual and all-day. Perform the following steps to set the threshold for the diagnosing and the linkage actions.

Steps:

1. Enter Video Quality Diagnostics settings interface in Camera Management and select a channel you want to detect video tampering.

Menu> Video> Video Quality

2. Click the checkbox to Enable Video Quality Diagnostics.
3. Enable and set the threshold for the diagnostic type which includes Blurred Image, Abnormal Brightness and Colour Cast. Click the corresponding checkbox for the diagnostic type and adjust the threshold by clicking-and-dragging the bar.

The higher the threshold you set, the greater the exception will be detected.

4. Click **Settings**  to set handling method for video tampering. Set arming schedule and alarm response actions for the channel.

1) Click **Arming Schedule** tab to set the arming schedule response action.

2) Choose a day of the week and up to eight time periods within each day.

Time periods must not be duplicated or overlap.

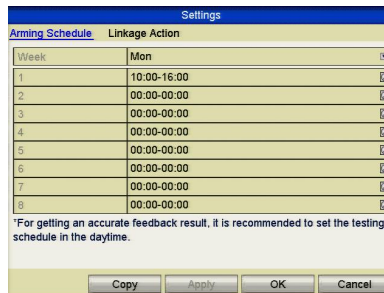

Figure 8.6.1 Set Arming Schedule for Video Quality Diagnostics

3) Select **Linkage Action** tab to set alarm response actions for video tampering alarm (please refer to *Setting Alarm Response Actions later in this chapter*).

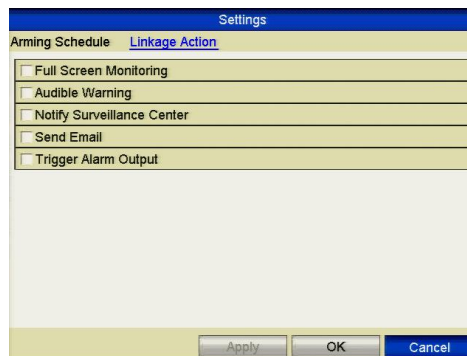

Figure 8.6.2 Set Linkage Action

Repeat the above steps to set arming schedule for other days of the week. You can also use the **Copy** button to copy an arming schedule for other days.

4) Click the **OK** button to complete the video tampering settings for the channel.

5. Click the **Apply** button to save and activate settings.

6. (Optional) you can copy the same settings to other cameras by clicking the **Copy** button.

8.7 Handling Exceptions

Purpose:

Exception settings refer to the handling method for various exceptions, e.g.

- **HDD Full:** The HDD is full.
- **HDD Error:** Writing HDD error, unformatted HDD, etc.
- **Network Disconnected:** Disconnected network cable.
- **IP Conflicted:** Duplicated IP address.
- **Illegal Login:** Incorrect user ID or password.
- **Input/Recording Resolution Mismatch:** The input resolution is smaller than the recording resolution.
- **Record Exception:** No space for saving recorded files.

Steps:

1. Enter Exceptions interface and handle various exceptions.
Menu> Setup> Exceptions

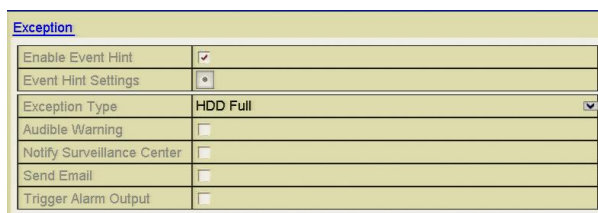



Figure 8.7.1 Exception Settings Interface

2. Click the checkbox of **Enable Event Hint** to display the  (Event Hint Settings icon) which when selected displays the Event Hint Settings menu. Then tick the detailed event hint for display. If the alarm icon  appears in the live view interface you can view the detailed information of the exception event. By clicking the **Set** button you can select the detailed event hint for display.

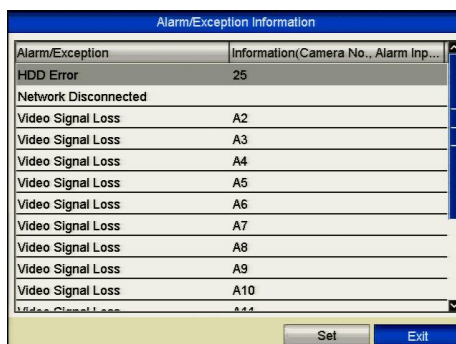

Figure 8.7.2 Detailed Event

3. Set the alarm linkage actions. For details, see Chapter below.

4. Click **Apply** to save the settings.

8.8 Setting Alarm Response Actions

Purpose:

Alarm response actions will be activated when an alarm or exception occurs, including Full Screen Monitoring, Audible Warning (buzzer), Notify Surveillance Center, Send Email and Trigger Alarm Output.

Full Screen Monitoring

When an alarm is triggered, the local monitor (HDMI, VGA or CVBS monitor) will display in full screen mode, the video image for the alarming channel configured.

If alarms are triggered simultaneously for several channels, their full-screen images will be switched at an interval of 10 seconds (default dwell time). A different dwell time can be set by going to **Menu > Setup > Live View**.

Auto-switch will terminate once the alarm stops and you will be taken back to the Live View interface.

Audible Warning

Trigger an audible *beep* when an alarm is detected.

Notify Surveillance Center

Sends an exception or alarm signal to a remote alarm host when an event occurs. The alarm host refers to the PC installed with Remote Client.

The alarm signal will be transmitted automatically at detection mode when remote alarm host is configured. Please refer to *Chapter 9* for details of the alarm host configuration.

Send Email

Send an email with alarm information to a user or users when an alarm is detected.

Please refer to *Chapter 9* for details of Email configuration.

Trigger Alarm Output

Trigger an alarm output when an alarm is triggered.

Steps:

1. Enter Alarm Output interface.

Menu> Setup> Alarm> Alarm Output

Select an alarm output and set alarm name and dwell time. Click **Settings** button to set the arming schedule for alarm output.

If “Manually Clear” is selected in the dropdown list in Dwell Time, you can clear it only by going to **Menu> Instant> Alarm**.

Alarm Status	Alarm Input	Alarm Output
Alarm Output No.	Local->1	▼
Alarm Name		
Dwell Time	5s	▼
Settings	▶	

Figure 8.8.1 Alarm Output Settings Interface

2. Set up arming schedule for the alarm output.
 Choose a day of the week and up to 8 time periods within each day.
 Time periods must not be duplicated or overlap.

Settings		
Arming Schedule		
Week	Mon	▼
1	00:00-24:00	☑
2	00:00-00:00	☑
3	00:00-00:00	☑
4	00:00-00:00	☑
5	00:00-00:00	☑
6	00:00-00:00	☑
7	00:00-00:00	☑
8	00:00-00:00	☑

Copy Apply OK Cancel

Figure 8.8.2 Set Arming Schedule for Alarm Output

3. Repeat the above steps to set arming schedule for other days of the week. You can also use the Copy button to copy an arming schedule to other days.
 Click the **OK** button to complete the arming schedule setting.
4. Click the **Apply** button to save the settings.

8.9 Triggering or Clearing Alarm Output Manually

Purpose:

Sensor alarms can be triggered or cleared manually. If “Manually Clear” is selected in the dropdown dwell time list of an alarm output, the alarm can be cleared only by clicking **Clear** button in the following interface.

Steps:

Select the alarm output you want to trigger or clear and make related operations.

Menu> Instant> Alarm

Click **Trigger/Clear** button if you want to trigger or clear an alarm output.

Click **Trigger All** button if you want to trigger all alarm outputs.

Click **Clear All** button if you want to clear all alarm outputs.

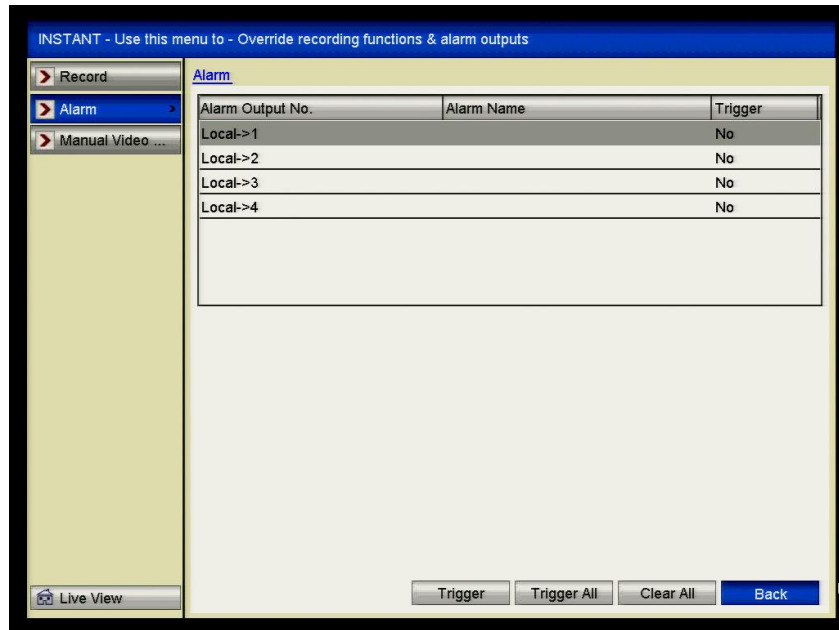

Figure 8.9.1 Clear or Trigger Alarm Output Manually

Chapter 9 Network Settings

9.1 Configuring General Settings

Purpose:

Network settings must be properly configured to allow you to operate the DVR over a network.

Steps:

1. Enter the Network Settings interface.

Menu > Setup > Network

General DDNS PPPOE NTP Email SNMP NAT More Settings	
NIC Type	10M/100M/1000M Self-adaptive
Enable DHCP	<input type="checkbox"/>
IPv4 Address	192 .168 .0 .241
IPv4 Subnet Mask	255 .255 .255 .0
IPv4 Default Gateway	192 .168 .0 .16
IPv6 Address 1	
IPv6 Address 2	
IPv6 Default Gateway	
MAC Address	c0:56:e3:0e:c0:51
MTU(Bytes)	1500
Preferred DNS Server	192.168.0.8
Alternate DNS Server	8.8.8.8

Figure 9.1.1 Network Settings

Note that the MAX416 has an additional option as this DVR has two LAN cards. You can therefore select either LAN1 or LAN2. All other MEGA units only have one.

One self-adaptive 10M/100M/1000M network interface is provided for MEGA204, MEGA208, MEGA216 AND MAX316.

Two self-adaptive 10M/100M/1000M network interfaces are available on the MAX416 which provide three configurable working modes: multi-address, load balance and network fault tolerance modes.

2. Select the **General** tab.
3. In the **General Settings** interface, you can configure the following settings: Working mode (applicable for MAX416 only), NIC Type, IPv4 Address, IPv4 Gateway, MTU and DNS Server.
If a DHCP server is available, you can click the **DHCP** checkbox to automatically obtain an IP address and other network settings from that server. A valid value for MTU is from 500 to 1500.
4. After having configured the general settings, click the **Apply** button to save the settings.

Working Mode

There are two 10M/100M/1000M NIC cards provided in the MAX416 DVR. This allows the DVR to work in the Multi-address, Load Balance and Net-fault Tolerance modes.

Multi-address Mode: The parameters in the two NIC cards can be configured independently. You can select LAN1 or LAN2 in the NIC type field for parameter settings. You can select one NIC card as a default route. When the system is connecting via an extranet the data will be forwarded through the default route.

Net-fault Tolerance Mode: This mode allows two NIC cards to use the same IP address and you can select the Main NIC to LAN1 or LAN2. In this way, in the case of one NIC card failing, the device will automatically enable the other standby NIC card so ensuring normal running conditions are maintained.

Load Balance Mode: By using the same IP address with two NIC cards that share the load of the total bandwidth, this mode enables the system to provide two Gigabit network capacity.

9.2 Configuring Advanced Settings

9.2.1 Configuring DDNS

Purpose:

If your router is setup on a dynamic service you may use this facility for resolving the dynamic address.

Steps:

1. Enter the Network Settings interface.
Menu > Setup > Network
Change the Preferred DNS Server to the same address as the IPv4 Default Gateway. Change the Alternate DNS Server to 8.8.8.8
Now click apply.
2. Select the **DDNS** tab to enter the DDNS Settings interface.

General DDNS PPPOE NTP Email SNMP NAT More Settings	
Enable DDNS	<input type="checkbox"/>
DDNS Type	AlienDDNS
Server Address	ippostcode.com
Device Domain Name	ippostcode.com
User Name	Not Required
Password	
Email	

NOTE: Device Domain Name will have the serial number of the DVR preceding ippostcode.com

Apply Back

Figure 9.2.1.1 DDNS Settings Interface

3. Click the **ENABLE DDNS** checkbox to enable this feature.
4. If you are using the AlienDDNS service then all you need to do, is to enter a valid Email address in the box, right of Email and press Apply then wait.
When you click in the blank Email box you will see a keyboard displayed. Select the characters to complete the Email address. Special characters such as dot or @ can be selected by clicking on the dot and comma under the letter A.
Subsequent lines of special characters are accessed using right arrow button.

NOTE: The dot is a special character and is number 2 and not number 1. The @ sign is accessed by clicking on the right arrow key to select the second line of special characters and is under number 5. Press **APPLY** then wait.

The ALIENDDNS service will send a six character password to the Email address and will display “**RECORD CREATED**”.

Write down the password and enter in the Password box then click **Apply** and wait. When the message “**UPDATE SUCCESSFUL**” is displayed, the DDNS service is ready to use after exiting menu.

If you wish to use a third party dynamic service then you can chose one of the optional alternatives.

5. Select alternative **DDNS Type**. Four additional DDNS types are selectable: IPServer, DynDNS, PeanutHull or NO-IP.

- **IPServer:** Enter **Server Address** for IPServer.

Enable DDNS	<input checked="" type="checkbox"/>
DDNS Type	IPServer
Server Address	172.17.45.79
Device Domain Name	
User Name	
Password	

Figure 9.2.1.2 IPServer Settings Interface

- **DynDNS:**
 - 1) Enter **Server Address** for DynDNS (i.e. members.dyndns.org).
 - 2) In the DVR Domain Name text field, enter the domain obtained from the DynDNS website.
 - 3) Enter the **User Name** and **Password** registered in the DynDNS website.

Enable DDNS	<input checked="" type="checkbox"/>
DDNS Type	DynDNS
Server Address	members.dyndns.org
Device Domain Name	test.dyndns.com
User Name	test
Password	*****

Figure 9.2.1.3 DynDNS Settings Interface

- **PeanutHull:** Enter the **User Name** and **Password** obtained from the PeanutHull website.

Enable DDNS	<input checked="" type="checkbox"/>
DDNS Type	PeanutHull
Server Address	
Device Domain Name	
User Name	test
Password	*****

Figure 9.2.1.4 PeanutHull Settings Interface

- **NO-IP:**

Enter the account information in the corresponding fields. Refer to the DynDNS settings.

- 1) Enter **Server Address** for NO-IP.
- 2) In the DVR Domain Name text field, enter the domain obtained from the NO-IP website (www.no-ip.com).
- 3) Enter the **User Name** and **Password** registered in the NO-IP website.

Enable DDNS	<input checked="" type="checkbox"/>
DDNS Type	NO-IP
Server Address	no-ip.org
Device Domain Name	test.no-ip.org
User Name	test
Password	*****

Figure 9.2.1.5 NO-IP Settings Interface

9.2.2 Configuring PPPoE Settings

Purpose:

The DVR also allows access by Point-to-Point Protocol over Ethernet (PPPoE). The PPPoE service is not generally used in the UK and is aimed at the American market.

Steps:

1. Enter the **Network Settings** interface.
Menu > Configuration > Network
2. Select the **PPPoE** tab to enter the PPPoE Settings interface.

Enable PPPOE	<input checked="" type="checkbox"/>
User Name	
Password	

Figure 9.2.2.1 PPPoE Settings Interface

3. Click the **PPPoE** checkbox to enable this feature.
4. Enter **User Name** and **Password** for PPPoE access.

The User Name and Password should be assigned by your ISP.

5. Click the **Apply** button to save the settings.
6. After successful settings, the system asks you to reboot the device to enable the new settings, and the PPPoE dial-up is automatically connected after reboot. You can go to Menu > Maintenance > System Info > Network interface to view the status of PPPoE connection.

9.2.3 Configuring NTP Server

Purpose:

A Network Time Protocol (NTP) Server can be configured on your DVR to ensure the accuracy of system date/time.

Steps:

1. Enter the Network Settings interface.
Menu > Setup > Network
2. Select the **NTP** tab to enter the NTP Settings interface.

Enable NTP	<input checked="" type="checkbox"/>
Interval (min)	60
NTP Server	210.72.145.44
NTP Port	123

Figure 9.2.3.1 NTP Settings Interface

3. Check the **Enable NTP** checkbox to enable this feature.
4. Configure the following NTP settings:
 - **Interval:** Time interval between synchronisation with NTP server. The time is in minutes.
 - **NTP Server:** IP address of NTP server.
 - **NTP Port:** Port of NTP server.
5. Click the **Apply** button to save and exit the interface.

The time interval can be set from 1 to 10080 minutes and the default value is 60 minutes. If the DVR is connected to a public network, you should use an NTP server that has a time synchronisation function, such as the server at the National Time Center (IP Address: 210.72.145.44).

9.2.4 Configuring SNMP

Purpose:

You can use SNMP protocol to get device status and parameters related information.

Steps:

1. Enter the Network Settings interface.
Menu > Setup > Network
2. Select the **SNMP** tab to enter the SNMP Settings interface.

Enable SNMP	<input checked="" type="checkbox"/>
SNMP Version	V2 <input type="checkbox"/>
SNMP Port	161
Read Community	public
Write Community	private
Trap Address	
Trap Port	162

Figure 9.2.4.1 SNMP Settings Interface

3. Check the **Enable SNMP** checkbox to enable this feature.

4. Configure the following SNMP settings:
 - **Trap Address:** IP Address of SNMP host.
 - **Trap Port:** Port of SNMP host.

5. Click the **Apply** button to save and exit the interface.

NOTE:

Before setting SNMP, please load the Alien Viewer to receive the device information via SNMP port. By setting the Trap Address, the DVR is allowed to send the alarm event and exception message to the surveillance center. Note that you do not need to use SNMP as the Alien Viewer will do this automatically.

9.2.5 Configuring NAT (UPnP)

Purpose:

Universal Plug and Play (UPnP) can permit automatic port forwarding on a router.

Before you start:

If you want to use the UPnP function in the device, you must enable the UPnP function in the router to which your device is connected. When the network working mode of the device is set as multi-address, the Default Route of the device should be in the same network segment as that of the LAN IP address of the router.

Steps:

1. Enter the Network Settings interface.
Menu > Setup > Network

2. Select the **NAT** tab to enter the UPnP settings interface.

Enable UPnP						<input checked="" type="checkbox"/>
Mapping Type						Manual
Port Type	Edit	External ...	External IP Address	Port	UPnP Status	
HTTP Port		80	0.0.0.0	80	Inactive	
RTSP Port		1240	0.0.0.0	1241	Inactive	
Server Port		8240	0.0.0.0	8241	Inactive	
HTTPS Port		443	0.0.0.0	443	Inactive	
						Refresh

Figure 9.2.5.1 UPnP Settings Interface

3. Click checkbox to enable UPnP.
4. Select the Mapping Type as Manual or Auto in the drop-down list.

OPTION 1: Auto

If you select Auto, the Port Mapping items are read-only and the external ports are set by the router automatically.

- 1) Click **Apply** button to save the settings.
- 2) You can click **Refresh** button to get the latest status of the port mapping.







Enable UPnP		<input checked="" type="checkbox"/>			
Mapping Type		Auto			
Port Type	Edit	External ...	External IP Address	Port	UPnP Status
HTTP Port		80	0.0.0.0	80	Inactive
RTSP Port		1241	0.0.0.0	1241	Inactive
Server Port		8241	0.0.0.0	8241	Inactive
HTTPS Port		443	0.0.0.0	443	Inactive
<input type="button" value="Refresh"/>					

Figure 9.2.5.2 UPnP Settings Finished-Auto

OPTION 2: Manual

If you select Manual as the mapping type, you can edit the external port by clicking  to activate the External Port Settings dialogue box.

Steps:

- 1) Click  to activate the External Port Settings dialogue box. Configure the external port No. for server port, http port and RTSP port respectively.
 - You can use the default port number or change it according to actual requirements.
 - External Port indicates the port No. for port mapping in the router.
 - The value of the RTSP port No. should be 554 or between 1024 and 65535, while the value of the other ports should be between 1 and 65535 and the value must be different from each other. If multiple devices are configured for the UPnP settings within the same router, the port number for each device should be unique.

External Port Settings	
Port Type	RTSP Port
External Port	554
<input type="button" value="OK"/> <input type="button" value="Cancel"/>	

Figure 9.2.5.3 External Port Settings Dialogue Box

- 2) Click **Apply** button to save the settings.
- 3) You can click **Refresh** button to get the latest status of the port mapping.

Enable UPnP <input checked="" type="checkbox"/>					
Mapping Type: Manual					
Port Type	Edit	External ...	External IP Address	Port	UPnP Status
HTTP Port		80	0.0.0.0	80	Inactive
RTSP Port		1240	0.0.0.0	1241	Inactive
Server Port		8240	0.0.0.0	8241	Inactive
HTTPS Port		443	0.0.0.0	443	Inactive
Refresh					

Figure 9.2.5.4 UPnP Settings Finished-Manual

9.2.6 Configuring More Settings

Steps:

1. Enter the Network Settings interface.
Menu > Setup > Network
2. Select the **More Settings** tab to enter the More Settings interface.

Alarm Host IP	
Alarm Host Port	0
Server Port	8240
HTTP Port	80
Multicast IP	
RTSP Port	1240

Figure 9.2.6.1 More Settings Interface

3. Configure the remote alarm host, server port, HTTP port, multicast, RTSP port.
 - **Alarm Host IP/Port:** With a remote alarm host configured, the device will send the alarm event or exception message to the host when an alarm is triggered. **This option is currently under development.**
 - **Alarm Host IP** refers to the IP address of the remote PC on which the Client software is installed and the **Alarm Host Port** must be the same as the alarm monitoring port configured in the software (default port is 7200). **This option is currently under development.**
 - **Multicast IP:** The multicast option can be configured to view more than the maximum number of cameras through the network. A multicast address spans the Class-D IP range of 224.0.0.0 to 239.255.255.255. It is recommended to use the IP address ranging from 239.252.0.0 to 239.255.255.255. When adding a device to the Client software, the multicast address must be the same as the device’s multicast IP.

- **RTSP Port:** The RTSP (Real Time Streaming Protocol) is a network control protocol designed for use in entertainment and communications systems to control streaming media servers.
Enter the RTSP port in the text field of **RTSP Port**. The default RTSP port is 1240 but you can change it according to different requirements.
- **Server Port and HTTP Port:** Enter the **Server Port** and **HTTP Port** in the text fields. The default Server Port is 8240 and the HTTP Port is 80 but you can change them according to different requirements.
The Server Port should be set to the range of 2000-65535 and it is used for remote client software access. The HTTP port is used for remote IE access.

Alarm Host IP	192.0.0.10
Alarm Host Port	7200
Server Port	8240
HTTP Port	80
Multicast IP	239.252.2.50
RTSP Port	1240

Figure 9.2.6.2 Configure More Settings

4. Click the **Apply** button to save and exit the interface.

9.2.7 Configuring HTTPS Port

Purpose:

HTTPS provides authentication of the web site and associated web server that one is communicating with, which protects against malware attacks. Perform the following steps to set the port number of https.

Example:

If you set the port number as 443 and the IP address is 192.168.0.64, you may access the device by inputting ***https://192.168.0.64:443*** via the web browser.

The HTTPS port can be only configured through the web browser.

Steps:

1. Open web browser, input the IP address of device, and the web server will select the language automatically according to the system language and maximise the web browser.
2. Input the correct user name and password, and click **Login** button to log into the device.
3. Enter the HTTPS settings interface.
Configuration > Remote Configuration > Network Settings > HTTPS
4. Create the self-signed certificate or authorised certificate.

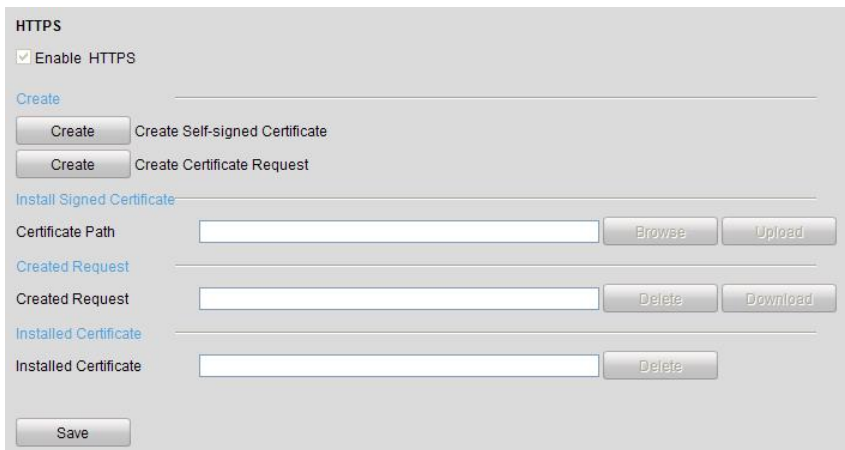

Figure 9.2.7.1 HTTPS Settings

OPTION 1: Create the self-signed certificate

1) Click the **Create** button to create the following dialogue box.

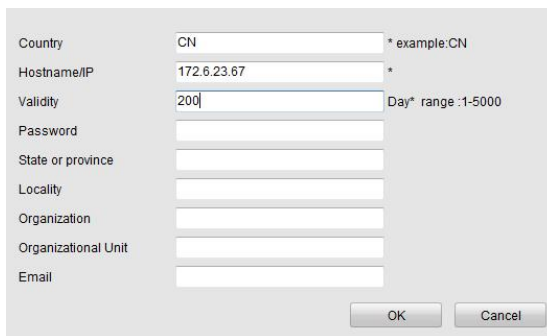

Figure 9.2.7.2 Create Self-signed Certificate

2) Enter the country, host name/IP, validity and other information.

3) Click **OK** to save the settings.

OPTION 2: Create the authorised certificate

1) Click the **Create** button to create the certificate request.

2) Download the certificate request and submit it to the trusted certificate authority for signature.

3) After receiving the signed valid certificate, import the certificate to the device.

5. There will be certificate information after you successfully create and install the certificate.

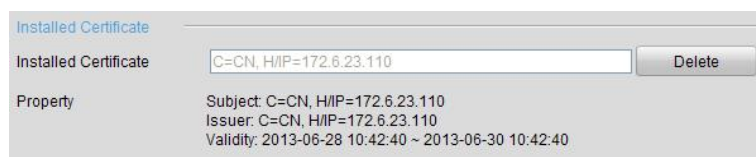

Figure 9.2.7.3 Installed Certificate Property

6. Check the checkbox to enable the HTTPS function.
7. Click the **Save** button to save the settings.

9.2.8 Configuring Email

Purpose:

The system can be configured to send an Email notification to all designated users if an event is detected, e.g. an alarm or motion event is detected, etc.

Before configuring the Email settings, the DVR must be connected to a local area network (LAN) that maintains an SMTP mail server. The network must also be connected to either an intranet or the Internet depending on the location of the e-mail accounts to which you want to send notification. Additionally, the Preferred DNS server must be configured.

Before you start:

Make sure you have configured the IPv4 Address, IPv4 Subnet Mask, IPv4 Gateway and the Preferred DNS Server in the Network Settings menu. Please refer to *Chapter 99.1 Configuring General Settings* for detailed information.

Steps:

1. Enter the Network Settings interface.
Menu > Setup > Network
2. Select the **Email** tab to enter the Email Settings interface

Enable Server Authentic...	<input type="checkbox"/>
User Name	
Password	
SMTP Server	
SMTP Port	25
Enable SSL	<input type="checkbox"/>
Sender	
Sender's Address	
Select Receivers	Receiver 1
Receiver	
Receiver's Address	
Enable Attached Picture	<input type="checkbox"/>
Interval	2s

Figure 9.2.8.1 Email Settings Interface

3. Configure the following Email settings:
 - Enable Server Authentication (optional):** Check the checkbox to enable the server authentication feature.
 - User Name:** The user account of sender's Email for SMTP server authentication.
 - Password:** The password of sender's Email for SMTP server authentication.
 - SMTP Server:** The SMTP Server IP address or host name (e.g., smtp.263xmail.com).

SMTP Port No.: The SMTP port. The default TCP/IP port used for SMTP is 25.

Enable SSL (optional): Click the checkbox to enable SSL if required by the SMTP server.

Sender: The name of sender.

Sender's Address: The Email address of sender.

Select Receivers: Select the receiver. Up to 3 receivers can be configured.

Receiver: The name of the receiver of the Email.

Receiver's Address: The Email address of the receiver.

Enable Attached Pictures: Check the checkbox of **Enable Attached Picture** if you want to send email with attached alarm images. The interval is the time between two captures of the alarm images.

Interval: The interval refers to the time between two actions of sending attached pictures.

E-mail Test: Sends a test message to verify that the SMTP server can be reached.

4. Click the **Apply** button to save the Email settings.
5. You can click the **Test** button to test whether your Email settings work. The corresponding messages are displayed.
6. There are a variety of display messages advising you of possible errors on each field completed when you fail to send an Email. A final message of "Email test succeeded" is displayed that requires a confirmation to proceed. The following is an example:



Figure 9.2.8.2 Email Testing Attention

9.3 Checking Network Traffic

Purpose:

You can check the network traffic to obtain real-time information about the DVR such as linking status, MTU, sending/receiving rate, etc.

Steps:

1. Enter the Network Traffic interface.
Menu > Tools > Net Detect

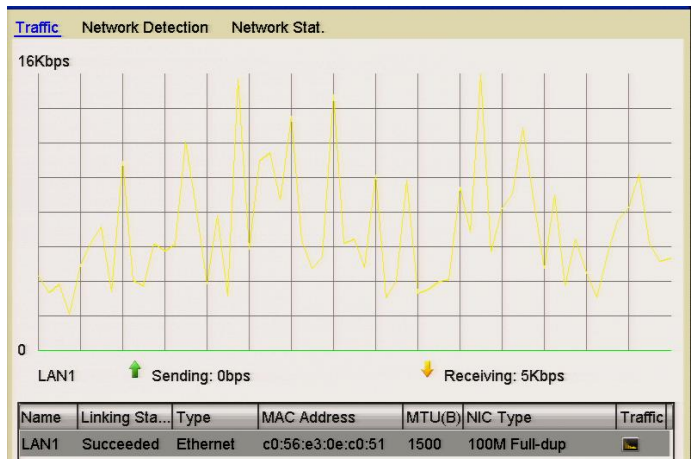

Figure 9.3.1 Network Traffic Interface

2. You can view the transmitting rate and receiving rate information via the interface. The traffic data is refreshed every 1 second.

9.4 Configuring Network Detection

Purpose:

You can obtain the network connection status of DVR through the network detection function, including network delay, packet loss, etc.

9.4.1 Testing Network Delay and Packet Loss

Steps:

1. Enter the Network Traffic interface.
Menu > Tools > Net Detect
2. Click the **Network Detection** tab to enter the Network Detection menu.

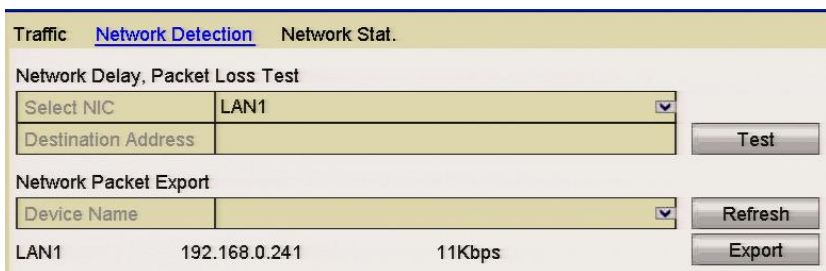

Figure 9.4.1.1 Network Detection Interface

3. Select a NIC to test network delay and packet loss.
4. Enter the destination address in the text field of **Destination Address**.
5. Click the **Test** button to start testing network delay and packet loss.

9.4.2 Exporting Network Packet

Purpose:

By connecting the DVR to a network, the captured network data packet can be exported to USB-flash disk, SATA and other local backup devices.

Steps:

1. Enter the Network Traffic interface.
Menu > Tools > Net Detect
2. Click the **Network Detection** tab to enter the Network Detection interface.
3. Select the backup device from the dropdown list in Device Name.

Click the **Refresh** button if the connected local backup device cannot be displayed. If it fails to detect the backup device, please check whether it is compatible with the DVR. You can format the backup device if the format is incorrect.

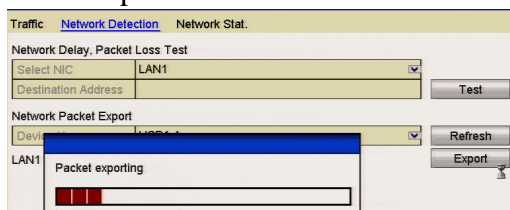

Figure 9.4.2.1 Export Network Packet

4. Click the **Export** button to start exporting.
5. After the exporting is complete, click **OK** to finish the packet export.

Up to 1M data can be exported each time.

9.4.3 Checking Network Status

Purpose:

You can also check the network status and quickly set the network parameters in this interface.

Steps:

Click Status on the right bottom of the page.

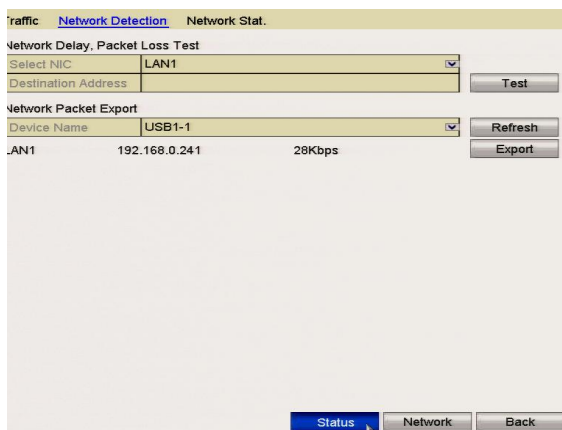

If the network is normal the following message displays.



Figure 9.4.3.2 Network Status Checking Result

If the display provides other information instead of this one, you can click the **Network** button to display the network parameters in the quick settings interface.

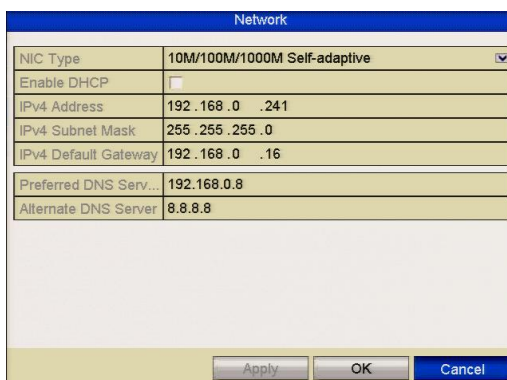

Figure 9.4.3.3 Network Parameters Configuration

9.4.4 Checking Network Statistics

Purpose:

You can check the network statistics to obtain the device real-time information.

Steps:

1. Enter the Network Statistics interface.
Menu > Tools> Net Detect
2. Click the **Network Stat.** tab to enter the Network Statistics menu.

Type	Bandwidth
IP Camera	0bps
Remote Live View	0bps
Remote Playback	0bps
Net Total Idle	200Mbps

Figure 9.4.4.1 Network Stat. Interface

3. View the bandwidth in Remote Live View, bandwidth of Remote Playback and bandwidth in Net Total Idle.
4. Click **Refresh** button to get the latest bandwidth statistics.

9.5 Networking your DVR

The following is a guide for doing the networking on your DVR.

Before you start you will need the following

- (a) **Monitor** connected to the DVR,
- (b) **Patch or LAN cable** connected between the DVR and the router,
- (c) **Windows PC** connected to the router (preferably with a cable connection although WIFI should work)
- (d) **User and Password** to access the router. On a BT router this may be on a plastic insert on the back of the router labelled Admin Password. On other routers the user and password is supplied with the router installation documentation.

Networking is split into several processes

- 1) Setting up the DVR for networking
- 2) Checking to ensure that the PC can see the DVR locally
- 3) Setting up port forwarding
- 5) Setting up a dynamic service
- 6) Checking ports are open
- 7) Setting up CCTV Window for local and remote connection
- 8) Setting up mobile phone for local and remote connection

1. Setting up the DVR for networking

1. Ensure your PC has Internet access via your router. Try accessing Google.
2. Connect a LAN or patch cable from DVR to router. (**NOT THE YELLOW CROSSOVER CABLE**)
3. In the DVR menu, select **Setup** then **Network** and tick **Enable DHCP** box. Press **Apply** and then **Back**.
4. Click on **Tools** and **Network** on the top line and **write down** the **IPv4 Address**, **IPv4 Subnet Mask** and **IPv4 Default Gateway**. If the IPv4 address is **192.0.0.64** then check the cable connection from the DVR to the router. This address means that the DVR cannot communicate with the router. Until this is resolved do not proceed. If the address is different, continue and click on **Back**.
5. Press **Setup** and then **Network** and untick **DHCP** box, then enter **IPv4 Address**, **Subnet Mask** and **Gateway** written down.
6. Click **Apply** and then select **NAT** or **UPnP** (Universal Plug and Play) at the top of the page.
7. NAT/UPnP should automatically do your port forwarding but this depends on router having the facility and enabled. (Also BT routers seem to have an inherent problem and seldom work.)
8. Click on **Enable UPnP** and you will see the three ports
HTTP Ext Port **80** External IP Address **0.0.0.0** Port **80** **Inactive**
RTSP Ext Port **1240** External IP Address **0.0.0.0** Port **1240** **Inactive**
Server Ext Port **8240** External IP Address **0.0.0.0** Port **8240** **Inactive**
HTTPS Ext Port **443** External IP Address **0.0.0.0** Port **443** **Inactive**

Click **Apply** and **Back**.

9. Now Re-enter **Setup, Network** and **NAT/UPnP** and see if the ports are **active** and remain the same, in **both External** and **Port** port columns.

10. If the ports are active, automatic port forwarding has worked. If they are **active** but **not the ports** detailed in step 8 click the **Auto down arrow key** and select **Manual**. Then click on edit signature and change the port numbers to **8240** (Server), **80** (HTTP) and **1240** (RTSP). Then click **Apply** then **Back**.

11. Check **UPnP** ports (**Setup, Network, NAT/UPnP**) are the correct ports and are **all active**. If they are then port forwarding has worked so go to **Process 5**. If not, **untick Enable UPnP, Apply** then **Back** and **Exit** menu completely. You will now need to do manual port forwarding.

2. Checking to ensure that the PC can see the DVR locally

12. Ensure the menu in the DVR is closed and go to the Windows PC keyboard that is connected to the router.

13. Ensure the PC is on the network and press the **Windows button** and the letter **R** to open a Command Run box.

14. In the run box type **CMD** then **enter** or click **OK**.

15. A black MSDOS screen will now be displayed with a flashing cursor.

16. Type **ping <space> <IPv4 Address supplied by DHCP in step 4>** and **Enter**

17. Check **packets sent, packets received** and **packets lost** at bottom of reply.

18. If not **4 packets sent, 4 packets received** and **0 packets lost** you have a problem with communication between the PC sending test data through the router to the DVR and returning to the PC. You can try pinging the router by going to step 13 through 15 and then type **ping <space> <IPv4 Default Gateway Address>** supplied by DHCP in step 4. The IPv4 Default Gateway address is the router local address. If packets are still lost the problem is no/bad connection between PC and router, but if okay then problem is between router and DVR. Do not proceed further until **4 packets sent, 4 packets received** and **0 packets lost** is displayed.

3. Setting up port forwarding

19. If the NAT/UPnP option has not worked, then port forwarding will have to be done manually. The purpose of port forwarding is for the router to allow communication on a predetermined incoming port received on the external side of the router, to be passed through the router firewall to the local address of the DVR. The DVR will process the data and return it to the router using the IPv4 Default Gateway Address which is the router's local address.

As there are hundreds of routers on the market, they will have various options for port forwarding. If you connect to <http://portforward.com> you can view a large range of router makes and models that will indicate how to do port forwarding. You probably will not find the ALIEN range of DVRs listed but you can select a device and apply the ALIEN DVR ports that are detailed in the DVR Menu, Setup, Network and More Settings.

The standard method on many routers is to enter the router menu using the user and password set in the router. Setup **SERVICES** usually giving each service a unique name for example DVR8240, DVR1240 and DVR80 selecting **TCP** and the **start** and **finish** port number (which is usually the same port number for start and end port.

Then go to port forwarding and assign each incoming port to the local address of the DVR which is the IPv4 address set in the Network page of the DVR.

To verify that the ports are open refer to process number **6. Checking ports are open.**

5. Setting up a dynamic service (Only use if router is not on a static service)

20. Enter the Network Settings interface.

Menu > Setup > Network

Change the **Preferred DNS Server** to the same address as the **IPv4 Default Gateway**. Change the **Alternate DNS Server** to **8.8.8.8**

Now click apply.

Select the **DDNS** tab to enter the DDNS Settings interface.

Click the **ENABLE DDNS** checkbox to enable this feature.

If you are using the AlienDDNS service then all you need to do, is to enter a valid Email address in the box, right of Email and press Apply then wait.

When you click in the blank Email box you will see a keyboard displayed. Select the characters to complete the Email address. Special characters such as dot or @ can be selected by clicking on the dot and comma under the letter A.

Subsequent lines of special characters are accessed using right arrow button.

NOTE: The dot is a special character and is number 2 and not number 1.

The @ sign is accessed by clicking on the right arrow key to select the second line of special characters and is under number 5. Press **APPLY** then wait.

The ALIENDDNS service will send a six character password to the Email address and will display **“RECORD CREATED”**.

Write down the password and enter in the Password box then click **Apply** and wait.

When the message **“UPDATE SUCCESSFUL”** is displayed, the DDNS service is ready to use after exiting menu.

You can now use the Device Domain Name <**DVR serial no**>.ippostcode.com

If you wish to use a third party dynamic service then you can chose one of the optional alternatives. Select alternative **DDNS Type**. Four additional DDNS types are selectable: IPServer, DynDNS, PeanutHull or NO-IP. Refer to DDNS instructions earlier for further information.

6. Checking ports are open

21. The easiest method to check that ports are open is to run www.ping.eu and select option 5 Port Check.
22. Enter the public address of the router. This can be found by using a PC connected to the router and firing up Google and entering “**Whats My IP**”
This will return the public address of the router by opening one of the records found. Then enter the port numbers in turn and press **GO**. If port says **OPEN** then port forwarding has worked. If port says **CLOSED** then check DVR is out of the menu and Welcome screen and try again. If still closed then you will need to investigate further or get assistance.
23. To check if the dynamic system is working then instead of using an IP address and port, use the dynamic name and the port. If ports are closed but open when trying the current public address, the problem is not port forwarding but the dynamic service. Go into **DVR Menu, Setup, Network, DDNS** and check that the status of DDNS displays **UPDATE SUCCESSFUL**. If a different display, untick **Enable DDNS, Apply** then **Exit**, reboot DVR and then go back into **DDNS** menu and tick **Enable DDNS, Apply** and wait unit the unit returns **UPDATE SUCCESSFUL**. Exit completely from the menu and service should be running.

7. Setting up CCTVWindow for local and remote connection

Local Connection

24. If using CCTVWindow, launch the client.
25. Enter user **admin** password **666666**
26. Click on Setup.
27. In left hand column using mouse, double click the Alien Icon with eyes, to the left of the DVR name eg: ‘DVR No 1’
28. Modify Device Information window will be displayed
29. Enter the DVR’s IP address in Device IP field.
30. Ensure username and password are the same as that used to access the DVR menu. User is **admin** and Password by default is **555555**.

Port number is **8240**. Set channel number to number of channels on DVR.

31. Click on **Ok** to **Save**
32. Click on the **Preview** tab.
33. Click on the '+' sign to expand the DVR channels, then double click on a channel to display a picture. Alternatively double click the Alien Icon to display all channels. The local connection is now working.

34. Before going to the remote site, you need to find out what the public address of the router is. This can be found by using a PC connected to the router and firing up Google and entering "**Whats My IP.**" This will return the public address of the router by opening one of the records found. Make a note of this address.

Remote Connection

35. Go to the remote site and load the client software to the PC used for the remote connection.

36. Now run CCTVWindow and setup a similar entry to the local setting described above, steps 24 to 32, but instead of entering the local IP address, you need to enter the remote IP address as per step 34. If you are using the AlienDDNS service the dynamic name **<dvr serial no>.ippostcode.com** must be entered in CCTVWindow. This is explained below.

37. Launch CCTVWindow.

38. Enter user **admin** password **666666**

39. Click on Setup.

40. In left hand column using mouse, double click the Alien Icon with eyes, to the left of the DVR name eg: 'DVR No 1'

41. Modify Device Information window will be displayed

42. Change Register Mode from Normal IP to Normal Domain.

43. Enter the dynamic name **<dvr serial no>.ippostcode.com** in Normal Domain.

44. Ensure username and password are the same as that used to access the DVR

menu. User is **admin** and Password by default is **555555**.

Port number is **8240**. Set channel number to number of channels on DVR.

45. Click on the **Preview** tab.

46. Click on the '+' sign to expand the DVR channels, then double click on a channel to display a picture. Alternatively double click the Alien Icon to display all channels.

The remote connection is now working.

47. Note that you must use the local IP address for connecting locally ie: using the network in the building where the DVR is located. Conversely, you use the remote IP address or dynamic name of the router when your PC is remote.

8. Setting up mobile phone for local and remote connection

Local Connection

48. If the mobile phone is an iPhone you will need to load the Mobile App from the App Store. The file will be called ALIEN DVR. If the phone is an Android phone then download the Mobile App from www.aliendvr.com website. Note that phones using the Windows platform are not currently supported.

49. Add a device calling it something to distinguish it from being a remote connection e.g **DVRinternal**. In IP address field set the local IP address e.g **198.168.1.240** (see step 4) of the DVR. Ensure username and password is the same as that used to access the DVR menu. User is **admin** and Password by default is **555555**.

Port number is **8240**.

Remote Connection

50. Add a device calling it something to distinguish it from being a local connection e.g **DVRexternal**. In IP address/domain name field set the remote IP address e.g **80.56.168.221** (see step 34) of the DVR. If you are using the AlienDDNS service the dynamic name **<dvr serial no>.ippostcode.com** must be entered. The admin username, password and port must be entered as per example shown in step 49.

51. For mobile phone access use the local IP address of the DVR on WIFI in the building. Conversely, switch WIFI off to use the remote IP address or dynamic name of the router when your mobile phone is remote using the 3/4G network.

Chapter 10 HDD Management

10.1 Initialising HDDs

Purpose:

A newly installed hard disk drive (HDD) must be initialised before it can be used with your DVR.

Steps:

1. Enter the HDD Information interface.
Menu > Drives>General.



Figure 10.1.1 HDD Information Interface

2. Select HDD to be formatted.
3. Click the **Format** button.

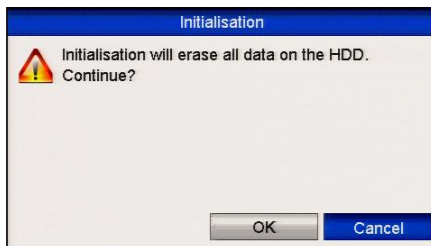

Figure 10.1.2 Confirm Initialisation

4. Select the **OK** button to start initialisation.

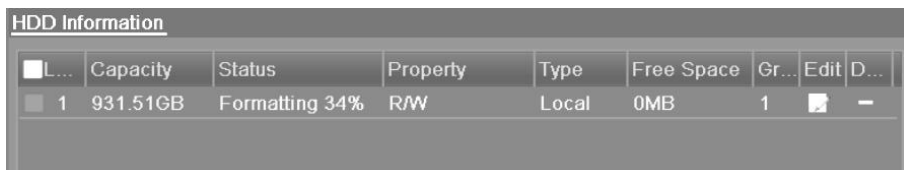

Figure 10.1.3 Start Initialisation

5. After the HDD has been initialised, the status of the HDD will change from *Uninitialised* to *Normal*.



Figure 10.1.4 HDD Status Changes to Normal

Note that initializing/formatting the HDD will erase all data on it.

To decrease the power consumption of the device and extend the life of the HDDs, the HDDs that are not in continuous use, can be put into sleep mode.

Click Menu > Drives > Advanced.



Figure 10.1.5 Enable HDD Sleeping

Click the checkbox to **Enable HDD Sleeping** (by default) and the HDDs that are not in continuous use, will be place in sleeping mode.

Unclick the checkbox for **Enable HDD Sleeping** and the HDDs will work continuously.

10.2 Managing Network HDD

Purpose:

You can add the allocated NAS or IP SAN disk and use it as a network HDD.

Steps:

1. Enter the HDD Information interface.

Menu > Drives>General



Figure 10.2.1 HDD Information Interface

2. Click the **Add** button to enter the Add NetHDD interface, as shown below.

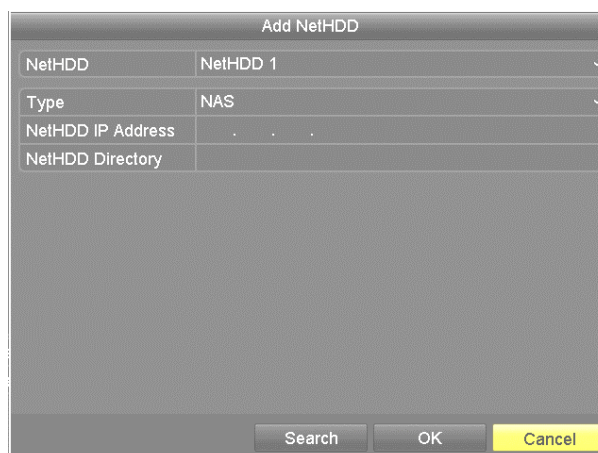
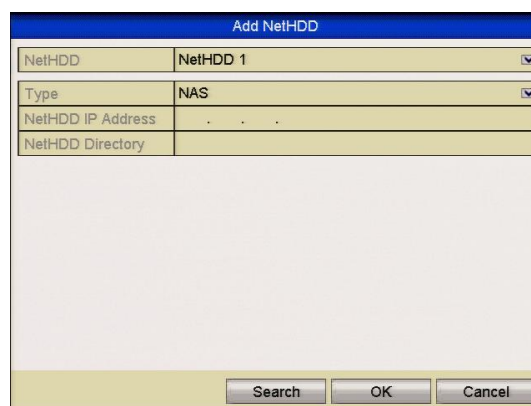

Figure 10.2.2 HDD Information Interface

3. Add the allocated NetHDD.
4. Select the type as NAS or IP SAN.
5. Configure the NAS or IP SAN settings.
 - **Add NAS disk:**
 - 1) Enter the NetHDD IP address in the text field.
 - 2) Click **Search** to search the available NAS disks.
 - 3) Select the NAS disk from the list shown below.
You can manually enter the directory in the text field of NetHDD Directory.
 - 4) Click **OK** to add the configured NAS disk.

Up to 8 NAS disks can be added.



Add NetHDD	
NetHDD	NetHDD 1
Type	NAS
NetHDD IP Address	. . .
NetHDD Directory	

Search OK Cancel

Figure 10.2.3 Add NAS Disk

- **Add IP SAN:**
 - 1) Enter the NetHDD IP address in the text field.
 - 2) Click the **Search** button to the available IP SAN disks.
 - 3) Select the IP SAN disk from the list shown below.
 - 4) Click the **OK** button to add the selected IP SAN disk.

Only one IP SAN disk can be added.



Figure 10.2.4 Add IP SAN Disk

- 5) After having successfully added the NAS or IP SAN disk, return to the HDD Information menu. The added NetHDD will be displayed in the list. If the added NetHDD is uninitialised, please select it and click the **Init** button for initialisation.



Figure 10.2.5 Initialise Added NetHDD

10.3 Managing eSATA

Purpose:

When there is an external eSATA device connected to the DVR, you can configure eSATA for Recording (Record) or Backup (Export) and you can manage the eSATA in the DVR.

Steps:

1. Enter the Advanced Record Settings interface.
Menu >Record>Advanced
2. Select the eSATA type to Export or Record from the dropdown list of **eSATA**.
Export: use the eSATA for backup. Refer to **Backup using eSATA HDDs** in **Chapter 7.1.1 Backing up by Normal Video Search** for operating instructions.
Record: use the eSATA for record. Refer to the following steps for operating instructions.



Figure 10.3.1 Set eSATA Mode

- When the eSATA type is selected to Record, enter the HDD Information interface.

Menu > HDD>General

- Edit the property of the selected eSATA, or initialise it as required.

Two storage modes can be configured for the eSATA when it is used for Record. Please refer to **Managing HDD Group** and **Configuring Quota Mode** for details.

L...	Capacity	Status	Property	Type	Free Space	Gr...	Edit	D...
3	2,794GB	Normal	R/W	Local	2,319GB	1	-	-
25	1,397GB	Normal	R/W	eSATA	1,397GB	1	-	

Figure 10.3.2 Format Added eSATA

10.4 Managing HDD Group

10.4.1 Setting HDD Groups

Purpose:

Multiple HDDs can be managed in groups. Video from specified channels can be recorded onto a particular HDD group through HDD settings.

Steps:

- Enter the Storage Mode interface.
Menu > Drives > Advanced
- Set the **Mode** to Group, as shown below.

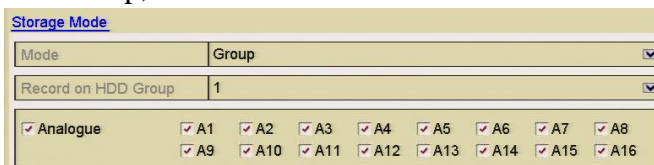

Figure 10.4.1.1 Storage Mode Interface

- Click the **Apply** button and the following will be displayed.

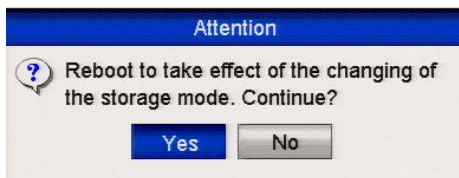

Figure 10.4.1.2 Attention for Reboot

- Click the **Yes** button to reboot the device to activate the changes.
- After the reboot enter the HDD Information interface.
Menu > Drives > General
- Select HDD from the list and click the icon to enter the Local HDD Settings interface.

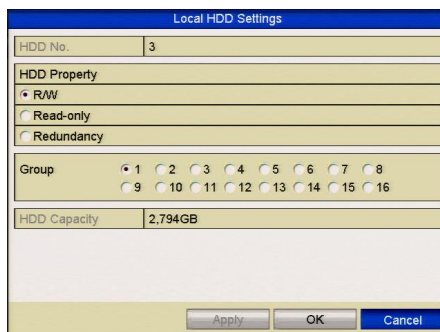

Figure 10.4.1.3 Local HDD Settings Interface

7. Select the Group number for the current HDD.
The default group No. for each HDD is 1.
8. Click the **OK** button to confirm the settings.

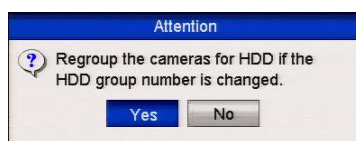

Figure 10.4.1.4 Confirm HDD Group Settings

9. Click the **Yes** button to complete the settings.

10.4.2 Setting HDD Property

Purpose:

The HDD property can be set to redundancy, read-only or read/write (R/W). Before setting the HDD property, please set the storage mode to Group (refer to step1-4 of **Chapter 10.4 Setting HDD Groups**).

An HDD can be set to read-only to prevent important recorded files from being overwritten when the HDD becomes full in overwrite recording mode.

When the HDD property is set to redundancy, the video can be recorded both onto the redundancy HDD and the R/W HDD simultaneously so as to ensure high security and reliability of video data.

Steps:

1. Enter the HDD Information interface.
Menu > Drives> General
2. Select HDD from the list and click the  icon to enter the Local HDD Settings interface.

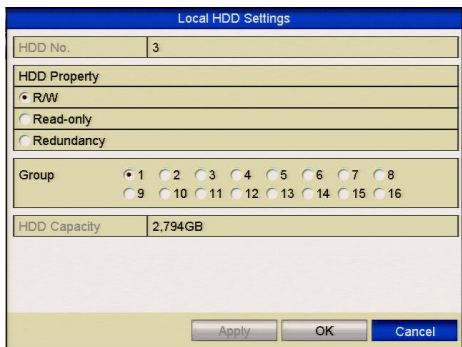

Figure 10.4.2.1 Set HDD Property

3. Set the HDD property to R/W, Read-only or Redundancy.
4. Click the **OK** button to save the settings and exit the interface.
5. In the HDD Information menu, the HDD property will be displayed in the list.

At least 2 hard drives must be added on your DVR when you want to set a HDD to Redundancy when there is one HDD with R/W property.

Configuring Quota Mode

Purpose

Each camera can be configured with allocated quota for the storage of recorded files.

Steps

1. Enter the Storage Mode interface.
Menu > Drives> Advanced
2. Set the **Mode** to Quota.

The DVR must be rebooted to enable the changes to take effect.

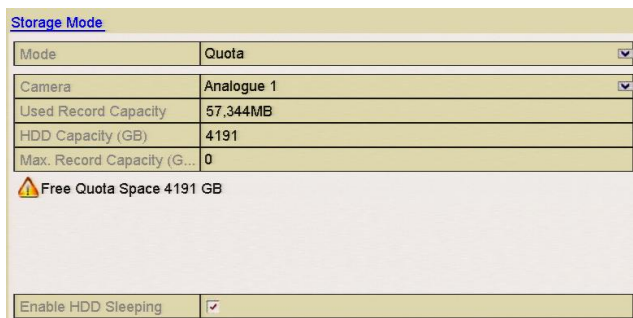

Figure 10.4.2.2 Storage Mode Settings Interface

3. Select a camera for which you want to configure quota.
4. Enter the storage capacity in the text field of **Max. Record Capacity (GB)**.
5. You can copy the quota settings of the current camera to other cameras if required. Click the **Copy** button to enter the Copy Camera interface, as shown below.

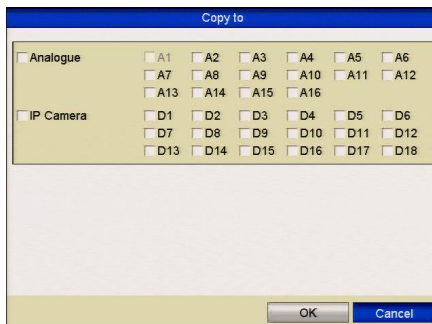

Figure 10.4.2.3 Copy Settings to Other Camera(s)

6. Select the camera (s) to be configured with the same quota settings. You can also click the checkbox of Analog to select all cameras.
7. Click the **OK** button to finish the Copy settings and return to the Storage Mode interface.
8. Click the **Apply** button to apply the settings.

If the quota capacity is set to 0, then all cameras will use the total capacity of HDD for recording.

10.5 Checking HDD Status

Purpose:

You may check the status of the installed HDDs on DVR so as to take immediate check and maintenance in case of HDD failure.

Checking HDD Status in HDD Information Interface

Steps:

1. Enter the HDD Information interface.
Menu > Drives>General
2. Check the status of each HDD which is displayed in the list.

L...	Capacity	Status	Property	Type	Free Space	Gr...	Edit	D...
3	2,794GB	Normal	RAW	Local	2,311GB	1		
25	1,397GB	Normal	RAW	eSATA	1,397GB	1		

Figure 10.5.1 View HDD Status (1)

If the status of HDD is *Normal* or *Sleeping*, it works normally. If the status is *Uninitialized* or *Abnormal*, please initialise the HDD before use. If the HDD initialisation fails, please replace it.

Checking HDD Status in System Information Interface

Steps:

1. Enter the System Information interface.
Menu > Tools > System Info
2. Click the **HDD** tab to view the status of each HDD displayed on the list, as shown below.

Label	Status	Capacity	Free Space	Property	Type	Group
3	Normal	2,794GB	2,311GB	R/W	Local	1
25	Normal	1,397GB	1,397GB	R/W	eSATA	1

Figure 10.5.2 View HDD Status (2)

10.6 Checking S.M.A.R.T Information

Purpose:

The S.M.A.R.T. (Self-Monitoring, Analysis and Reporting Technology) is a monitoring system for HDD to detect and report on various indicators of reliability in the hopes of anticipating failures.

Steps:

1. Enter the HDD Detect interface.
Menu > Tools > HDD Detect
2. Click the S.M.A.R.T. Settings tab to enter the interface.
3. Select the HDD to view its S.M.A.R.T. information list.

If you want to use the HDD even when the S.M.A.R.T. checking has failed, you can click the checkbox left of **Continue to use this disk when self-evaluation is failed.**

The screenshot shows the 'S.M.A.R.T. Settings' interface. At the top, there is a checkbox labeled 'Continue to use this disk when self-evaluation is failed.' Below this, a dropdown menu shows 'HDD' selected. The interface displays several status fields: 'Self-test Status' (Not tested), 'Self-test Type' (Short Test), 'S.M.A.R.T.' (indicated by a red arrow), 'Temperature' (33), 'Power On (days)' (101), 'Self-evaluation' (Pass), and 'All-evaluation' (Functional). Below these fields is a table titled 'S.M.A.R.T. Information' with columns for ID, Attribute Name, Status, Flags, Thresh..., Value, Worst, and Raw Value. The table lists several attributes such as Raw Read Error Rate, Spin Up Time, Start/Stop Count, Reallocated Sector Co..., Seek Error Rate, Power-on Hours Count, and Spin Up Retry Count.

ID	Attribute Name	Status	Flags	Thresh...	Value	Worst	Raw Value
0x1	Raw Read Error Rate	OK	f	6	117	99	152204328
0x3	Spin Up Time	OK	3	0	93	92	0
0x4	Start/Stop Count	OK	32	20	100	100	571
0x5	Reallocated Sector Co...	OK	33	36	100	100	0
0x7	Seek Error Rate	OK	f	30	66	59	120396191048
0x9	Power-on Hours Count	OK	32	0	98	98	2440
0xa	Spin Up Retry Count	OK	13	97	100	100	0

Figure 10.6.1 S.M.A.R.T Settings Interface

10.7 Detecting Bad Sector

Purpose:

You can detect bad sectors on the HDD to check the status of the HDD.

Steps:

1. Enter the HDD Detect interface.
Menu>Tools>HDD Detect

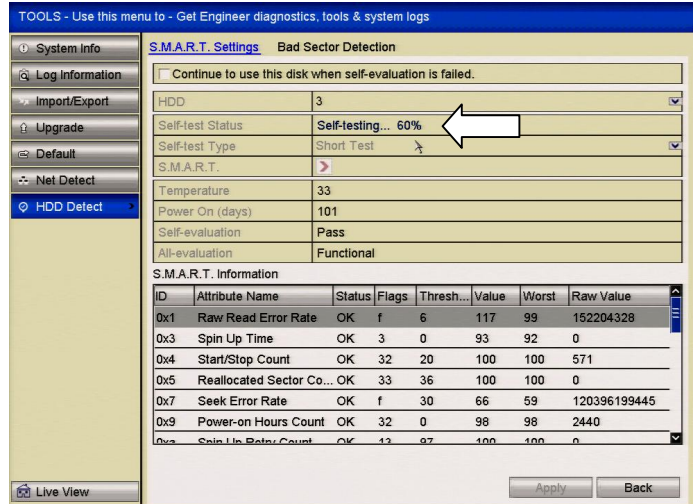

Figure 10.7.1 SMART Test

2. Click the Bad Sector Detection tab to enter the interface.
3. Select a HDD and click the **Detect** button to start detecting.

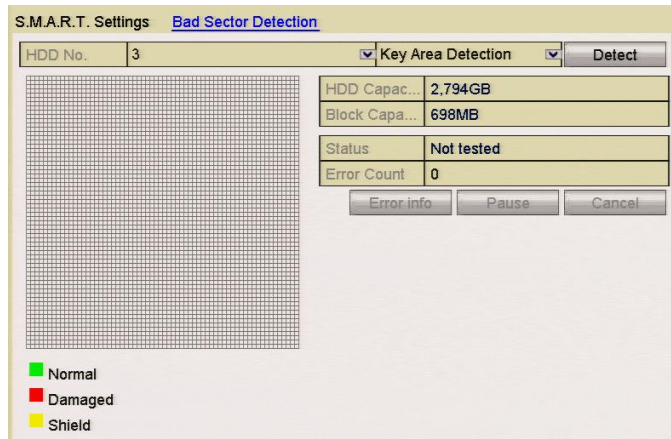

Figure 10.7.2 Bad Sector Detecting

4. You can click the **Pause** button to pause the detection and click the **Resume** button to resume the detection.
5. If there is error information about the HDD, you can click the **Error Info** button to view the information.

10.8 Configuring HDD Error Alarms

Purpose:

You can configure the HDD error alarms when the HDD status is *Uninitialised* or *Abnormal*.

Steps:

1. Enter the Exception interface.
Menu > Setup > Exceptions
2. Select the Exception Type **HDD Error** from the dropdown list.
3. Click the checkbox(s) below to select the linkage action(s) for HDD error.
The linkage actions can be selected from: Audible Warning, Notify Surveillance Center, Send Email and Trigger Alarm Output.
Please refer to *Chapter 8.8 Setting Alarm Response Actions*.

Exception	
Enable Event Hint	<input checked="" type="checkbox"/>
Event Hint Settings	<input type="radio"/>
Exception Type	HDD Error
Audible Warning	<input type="checkbox"/>
Notify Surveillance Center	<input checked="" type="checkbox"/>
Send Email	<input type="checkbox"/>
Trigger Alarm Output	<input checked="" type="checkbox"/>
<input type="checkbox"/> Alarm Output No.	Alarm Name
<input type="checkbox"/> Local->1	
<input type="checkbox"/> Local->2	
<input type="checkbox"/> Local->3	
<input type="checkbox"/> Local->4	

Figure 10.8.1 Configure HDD Error Alarm

4. When the Trigger Alarm Output is selected, you can also select the alarm output to be triggered from the list below. Click the Apply button to save the settings.

10.9 Configuring Privacy Mask

Purpose:

You are allowed to configure four privacy masking zones that cannot be viewed or recorded by the operator.

Steps:

1. Enter the Privacy Mask Settings interface.
Menu > Video > Privacy Mask
2. Select the camera to set privacy mask.
3. Click the **Enable Privacy Mask** checkbox to enable this feature.

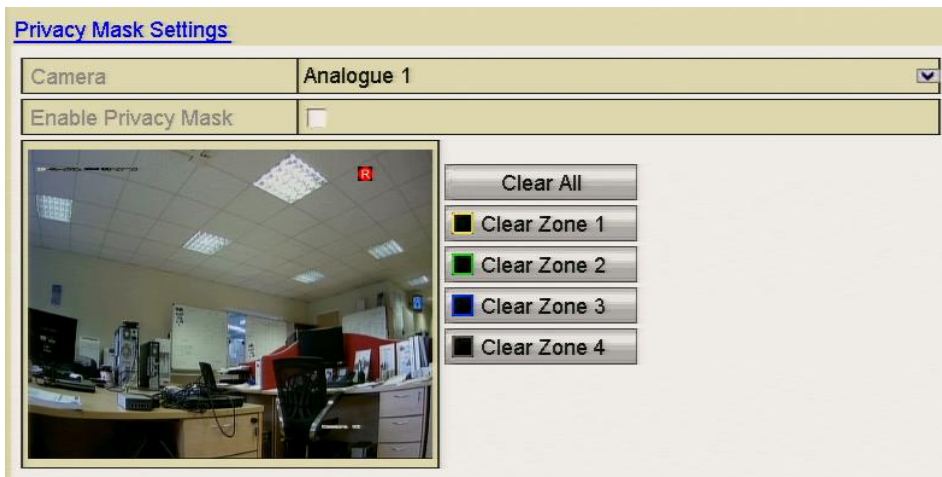

Figure 10.9.1 Privacy Mask Settings Interface

4. Use the mouse to draw a zone on the window. The zones will be marked with different frame colours.
Up to 4 privacy mask zones can be configured, and the size of each area can be adjusted.
5. The configured privacy mask zones on the window can be cleared by clicking the corresponding Clear Zone1-4 icons on the right side of the window or click **Clear All** to clear all zones.

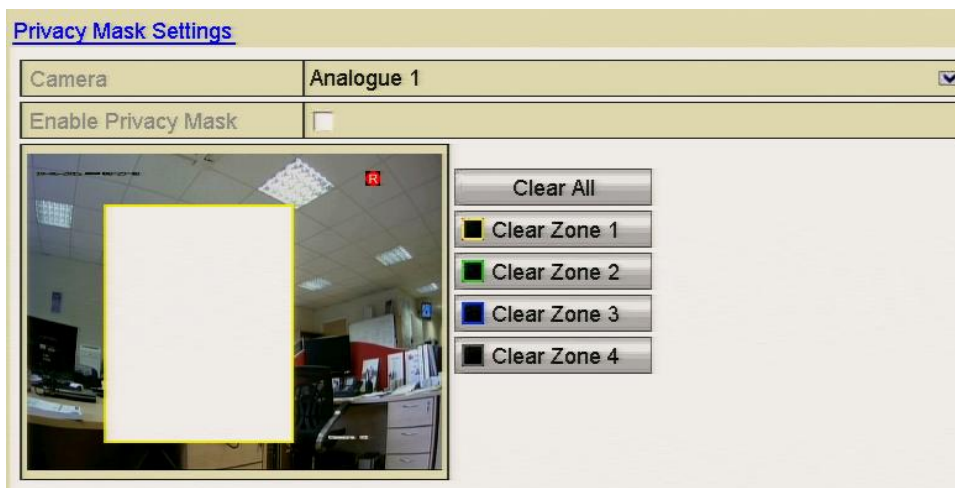

Figure 10.9.2 Set Privacy Mask Area

6. You can click the **Copy** button to copy the privacy mask settings of the current camera to other cameras.
7. Click the **Apply** button to save the settings.

10.10 Configuring Video Parameters

Steps:

1. Enter the Image Settings interface.
Menu > Video > Image

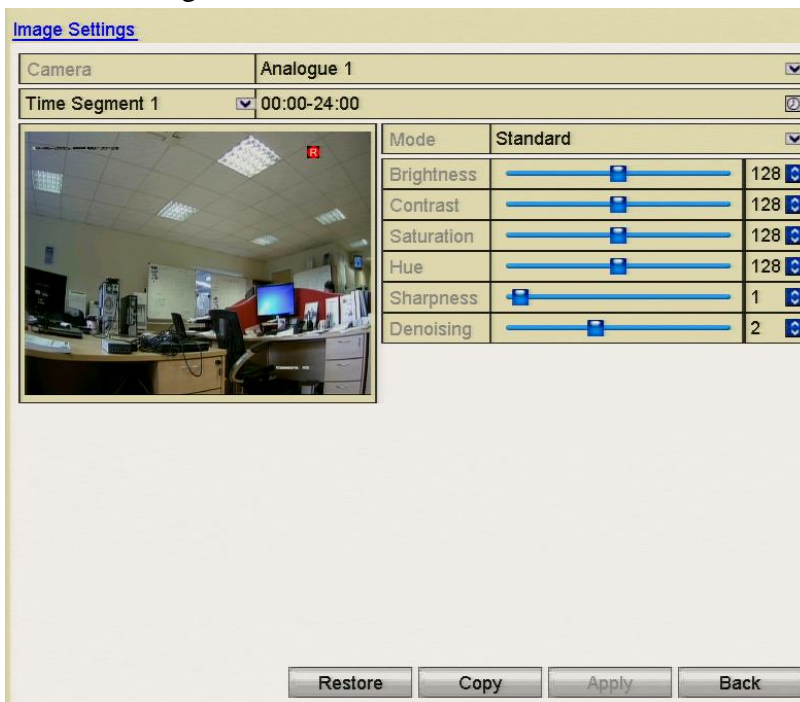

Figure 10.10.1 Image Settings Interface

2. Select the camera to set image parameters.
3. Two periods for different image settings are provided, select the period name in the dropdown list. This allows the setting of time in a 24 hour period and associate this time with brightness, contrast, saturation etc. The time periods cannot overlap each other.
4. Select the mode from the drop-down list of **Modes** which are: Standard, Indoor, Dim Light and Outdoor.
5. Adjust the image parameters according to actual needs. The parameters include Brightness, Contrast, Saturation, Hue, Sharpness and DE noising. You can also click **Restore** to set the parameters to the default settings.
6. You can click **Copy** to copy the image settings of the current camera to other analogue cameras.
7. Click **Apply** to save the settings.

10.11 Configuring OSD Settings

Purpose:

You can configure the OSD (On-screen Display) settings for the camera, including date /time, camera name, etc.

Steps:

1. Enter the OSD Configuration interface.
Menu > Video > OSD
2. Select the camera to configure OSD settings.
3. Edit the Camera Name in the text field.
4. Configure the Display Name, Display Date and Display Week by checking the checkbox.
5. Select the Date Format, Time Format, Display Mode and the OSD font.

OSD Configuration	
Camera	Analogue 1
Camera Name	Camera 01
	Display Name <input checked="" type="checkbox"/>
	Display Date <input checked="" type="checkbox"/>
	Display Week <input checked="" type="checkbox"/>
	Date Format DD-MM-YYYY
	Time Format 24-hour
	Display Mode Non-Transparent & Not Flashing
	OSD font 32x32

Figure 10.11.1 OSD Configuration Interface

6. You can use the mouse to click and drag the text box in the preview window to adjust the OSD position.
7. Copy Camera Settings
 - 1) If you want to copy the OSD settings of the current camera to other cameras, click the **Copy** button to enter the Copy Camera interface.

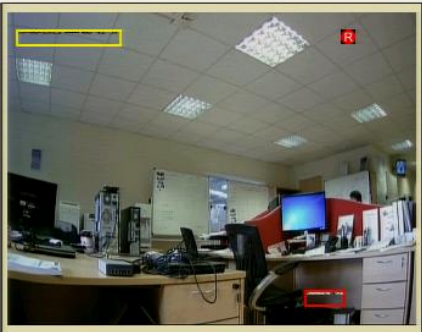
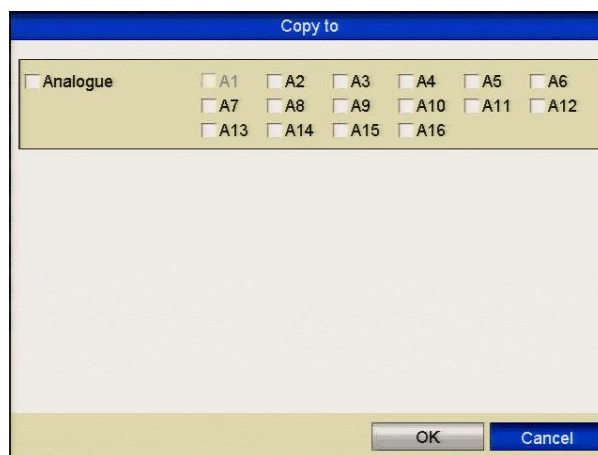

Figure 10.11.2 Copy Settings to Other Cameras

- 2) Select the camera (s) to be configured with the same OSD settings. You can also click the checkbox Analog to select all cameras.
 - 3) Click the **OK** button to finish the Copy settings and return to the OSD Configuration interface.
- 8.** Click the **Apply** button to apply the settings.

Chapter 11 DVR Management and Maintenance

11.1 Viewing System Information

Steps:

1. Enter the System Information interface.
Menu > Maintenance > System Info
2. You can click the **Device Info**, **Camera**, **Record**, **Alarm**, **Network** and **HDD** tabs to view the system information of the device.

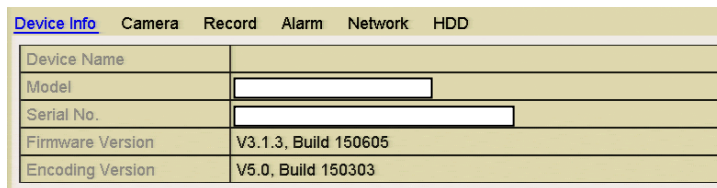

Figure 11.1.1 System Information Interface

11.2 Searching and Exporting Log Files

Purpose:

The operation, alarm, exception and information of the DVR can be stored in log files, which can be viewed and exported at any time.

Steps:

1. Enter the Log Search interface.
Menu > Tools > Log Information

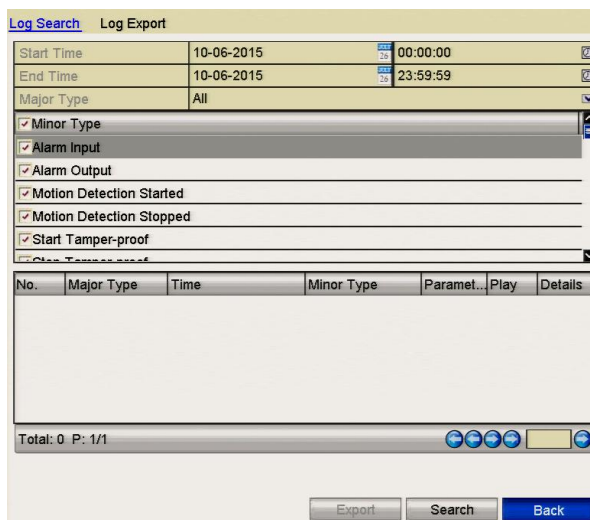

Figure 11.2.1 Log Search Interface

2. Set the log search conditions to refine your search, including the Start Time, End Time, Major Type and Minor Type.

3. Click the **Search** button to start search log files.
4. The matched log files will be displayed on the list shown below.

Up to 2000 log files can be displayed each time.

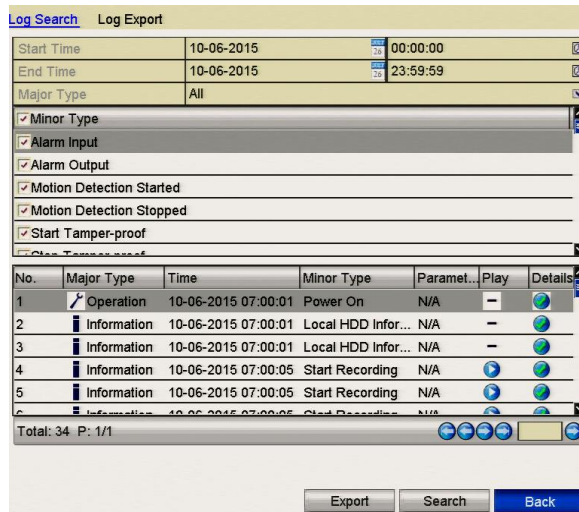

Figure 11.2.2 Log Search Results

5. You can click the button for each log or double-click it to view its detailed information, as shown below. You can also click the button to view the related video files if available.



Figure 11.2.3 Log Details

6. If you want to export the log files, click the **Export** button to enter the Export menu.

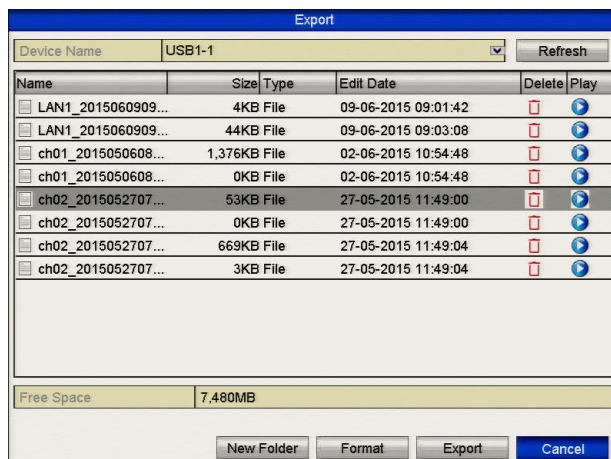

Figure 11.2.4 Export Log Files

7. Select the backup device from the dropdown list in **Device Name**.
8. Click the **Export** to export the log files to the selected backup device.
You can click the **New Folder** button to create a new folder in the backup device, or click the **Format** button to format the backup device before exporting the log.
 - Please connect the backup device to DVR before operating log export.
 - The log files exported to the backup device are named by exporting time, e.g., **20110514124841logBack.txt**.

11.3 Importing/Exporting IP Camera Info

Purpose:

The setup information regarding an IP camera can be copied into an Excel file and exported to a local backup device, including the IP address, port, admin password, etc. The exported file can be edited on your PC, by adding or deleting the content; and copy the settings to other devices by importing the Excel file.

Steps:

1. Enter the camera management interface.
Menu > Video > Camera>IP Camera Import/Export
2. Click the IP Camera Import/Export tab, the content of the detected external device appears.
3. Click the **Export** button to export configuration files to the selected local backup device.
4. To import a configuration file, select the file from the selected backup device and click the **Import** button. After the importing process is complete, you must reboot the DVR.

11.4 Importing/Exporting Configuration Files

Purpose:

The DVR configuration files can be exported to a local device for backup; and the configuration files from one DVR can be imported to multiple DVR devices if they are to be configured with the same parameters.

Steps:

1. Enter the Import/Export Configuration File interface.

Menu > Tools > Import/Export

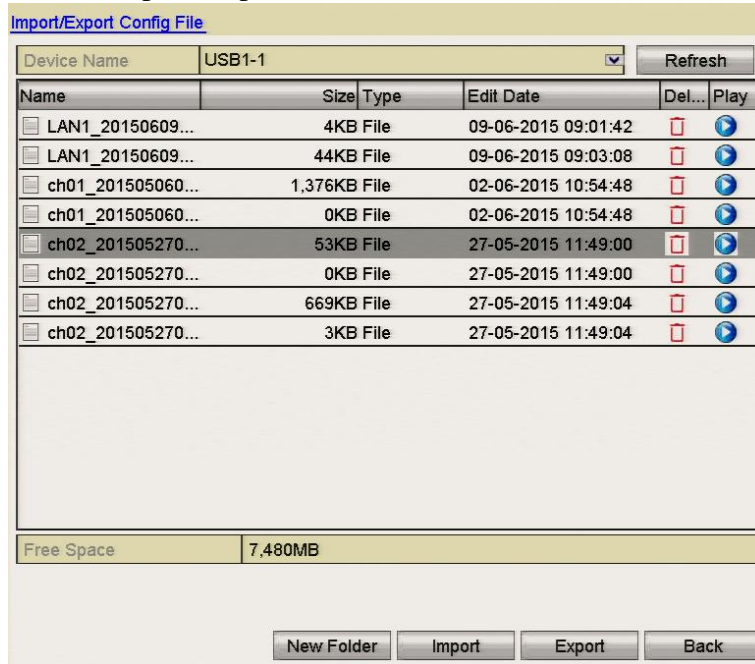

Figure 11.4.1 Import/Export Config File

2. Click the **Export** button to export configuration files to the selected local backup device.
3. To import a configuration file, select the file from the selected backup device and click the **Import** button. After the import process is complete, the DVR must be rebooted. However having finished the import of configuration files, the device will reboot automatically.

11.5 Upgrading Firmware

Purpose:

The firmware on your DVR can be upgraded by local backup device or remote FTP server.

Using incorrect firmware can leave your DVR unusable so never try any firmware upgrade unless you are absolutely sure it is the correct software.

11.5.1 Upgrading by Local Backup Device

Steps:

1. Connect your DVR with a local backup device where the update firmware file is located.
2. Enter the Upgrade interface.
Menu > Tools > Upgrade
3. Click the **Local Upgrade** tab to enter the local upgrade menu.

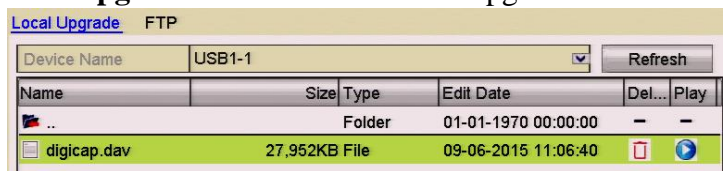

Figure 11.5.1.1 Local Upgrade Interface

4. Select the update file from the backup device.
5. Click the **Upgrade** button to start upgrading.
6. After the upgrading is complete, reboot the DVR to activate the new firmware.

11.5.2 Upgrading by FTP

Before you start:

Configure PC (running FTP server) and DVR in the same Local Area Network. Run the 3rd-party TFTP software on the PC and copy the firmware into the root directory of TFTP.

Steps:

1. Enter the Upgrade interface.
Menu > Maintenance > Upgrade
2. Click the **FTP** tab to enter the local upgrade interface as shown.

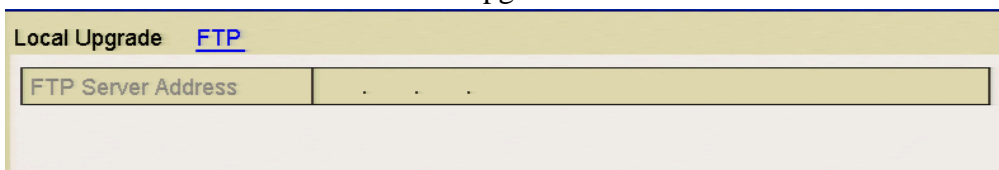

Figure 11.5.2.1 FTP Upgrade Interface

3. Enter the FTP Server Address in the text field.

4. Click the **Upgrade** button to start upgrading.
5. After the upgrading is complete, reboot the DVR to activate the new firmware.

11.6 Restoring Default Settings

Steps:

1. Enter the Default interface.
Menu > Tools > Default

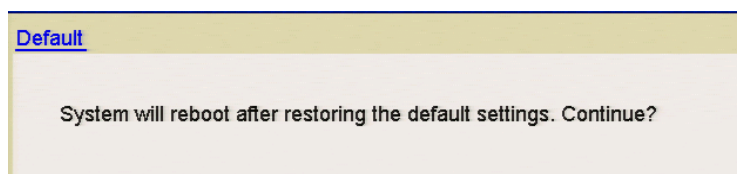

Figure 11.6.1 Restore Factory Default

2. Click the **OK** button to restore the default settings.

Except the network parameters (including IP address, subnet mask, gateway, MTU, default route and server port), all other parameters in the DVR will be restored to factory default settings.

Chapter 12 Others

12.1 Configuring RS-232 Serial Port

Purpose:

The RS-232 port can be used in two ways:

Parameters Configuration: Connect a PC to the device through the PC serial port. Device parameters can be configured by using software such as HyperTerminal. The serial port parameters must be the same as the device's when connecting through the PC serial port.

Transparent Channel: Connect a serial device directly to the device. The serial device will be controlled remotely by the PC through the network.

Steps:

1. Enter the RS-232 Settings interface.
Menu > Setup > RS-232

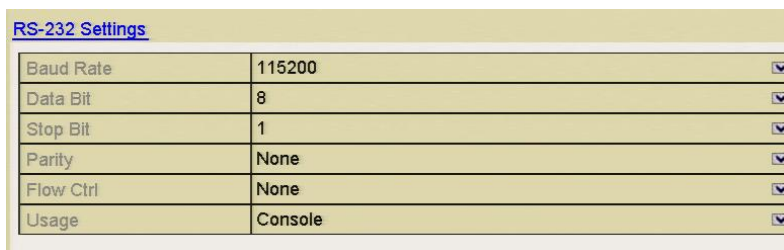

RS-232 Settings	
Baud Rate	115200
Data Bit	8
Stop Bit	1
Parity	None
Flow Ctrl	None
Usage	Console

Figure 12.1.1 RS-232 Settings Interface

2. Configure RS-232 parameters, including baud rate, data bit, stop bit, parity, flow control and usage.
3. Click **Apply** to save the settings.

12.2 Configuring General Settings

Purpose:

You can configure the output resolution, system time, mouse pointer speed, etc.

Steps:

1. Enter the General Settings interface.
Menu > Setup > General
2. Select the **General** tab.

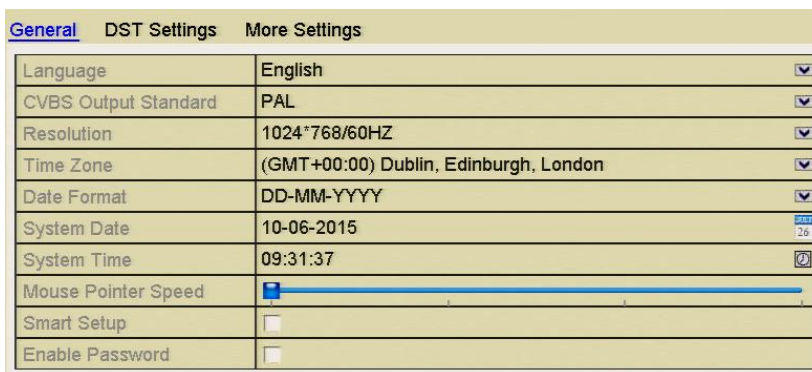

Figure 12.2.1 General Settings Interface

3. Configure the following settings:
 - **Language:** The default language used is *English*.
 - **CVBS Output Standard:** Select the CVBS output standard to NTSC or PAL, which must be the same with the video input standard.

Note that some DVR models provide no CVBS output.

- **Resolution:** Select the output resolution, which must be the same as the resolution of the VGA/HDMI monitor.
 - **Time Zone:** Select the time zone.
 - **Date Format:** Select the date format.
 - **System Date:** Select the system date.
 - **System Time:** Select the system time.
 - **Mouse Pointer Speed:** Set the speed of mouse pointer; 4 levels are configurable.
 - **Enable Wizard:** Enable/disable the Wizard when the device starts up.
 - **Enable ID Authentication:** Enable/disable the use of the login password.
4. Click the **Apply** button to save the settings.

12.3 Configuring DST (Daylight Saving Time)

Steps:

1. Enter the General Settings interface.
Menu >Setup>General
2. Select the **DST Settings** tab.

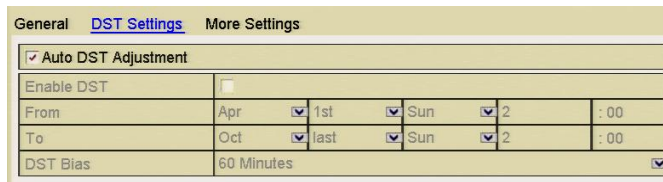

Figure 12.3.1 DST Settings Interface

Click the **Auto DST Adjustment** checkbox.

Alternatively you can manually click the **Enable DST** checkbox to set the date and time of the DST period.

12.4 Configuring More Settings

Steps:

1. Enter the General Settings interface.
Menu > Setup > General
2. Click the **More Settings** tab to enter the More Settings interface.

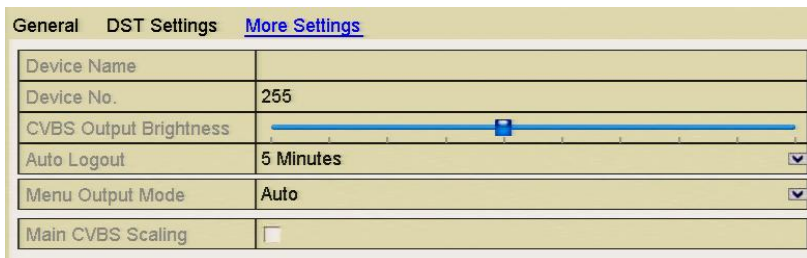

Figure 12.4.1 More Settings Interface

3. Configure the following settings:
 - **Device Name:** Edit the name of DVR.
 - **Device No.** Edit the DVR device number. This can be set in the range of 1~255. The default No. is 255.
 - **CVBS Output Brightness:** Adjust the video output brightness via the CVBS interface. The MEGA204, MEGA208 and MEGA216 provide no CVBS output.
 - **Auto Logout:** Set timeout time for menu inactivity. E.g., when the timeout time is set to *5 Minutes*, then the system will exit from the current operation menu to live view screen after 5 minutes of menu inactivity.
 - **Menu Output Mode:** You can choose the menu display on different video outputs. Setting Auto will allow the DVR to self detect on bootup.
 - **Main CVBS Scaling:** Enable/disable video output scaling for main CVBS video output.
 - Click the **Apply** button to save the settings.

12.5 Managing User Accounts

Purpose:

There is a default account in the DVR: *Administrator*. The *Administrator* user name is ***admin*** and the password is ***555555***. The *Administrator* has the permission to add and delete users and configure user parameters.

12.5.1 Adding a User

Steps:

1. Enter the User Management interface.
Menu > Setup > User

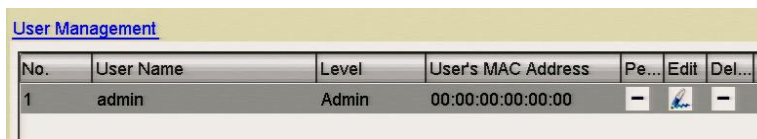

No.	User Name	Level	User's MAC Address	Pe...	Edit	Del...
1	admin	Admin	00:00:00:00:00:00	-		-

Figure 12.5.1.1 User Management Interface

2. Click the **Add** button to enter the Add User interface.

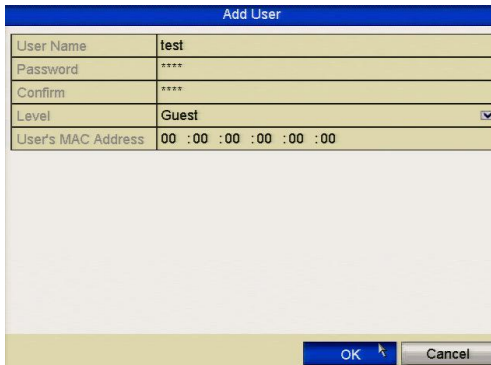

Add User	
User Name	test
Password	****
Confirm	****
Level	Guest
User's MAC Address	00 :00 :00 :00 :00 :00

OK Cancel

Figure 12.5.1.2 Add User Menu

3. Enter the information for new user, including **User Name**, **Password**, **Level** and **User's MAC Address**.
Level: Set the user level to Operator or Guest. Different user levels have different operating permissions.

- **Operator:** The *Operator* user level has permission for Local Log Search in Local Configuration, Remote Log Search and Two-way Audio in Remote Configuration and all operating permissions in Camera Configuration.
- **Guest:** The Guest user has permission for Local Log Search in Local Configuration, Remote Log Search in Remote Configuration and only has the

local/remote playback permission in the Camera Configuration.

User's MAC Address: The MAC address of the remote PC which logs onto the DVR. If it is configured and enabled, it only allows the remote user with this MAC address to access the DVR.

- Click the **OK** button to save the settings and go back to the User Management interface. The added new user will be displayed in the list as shown below.

No.	User Name	Level	User's MAC Address	Pe...	Edit	Del...
1	admin	Admin	00:00:00:00:00:00	-		-
2	test	Guest	00:00:00:00:00:00			

Figure 12.5.1.3 Added User Listed in User Management Interface

- Select the user from the list and then click the button to enter the Permission settings interface.

Figure 12.5.1.4 User Permission Settings Interface

- Set the operating permissions in Local Configuration, Remote Configuration and Camera Configuration for the user.

Local Configuration

- Local Log Search: Searching and viewing logs and system information.
- Local Parameters Settings: Configuring parameters, restoring factory default parameters and importing/exporting configuration files.
- Local Advanced Operation: Operating HDD management (initialising HDD, setting HDD property), upgrading system firmware, clearing I/O alarm output.
- Local Shutdown Reboot: Shutting down or rebooting the DVR.

Remote Configuration

- Remote Log Search: Remotely viewing logs that are saved on the DVR.
- Remote Parameters Settings: Remotely configuring parameters, restoring factory default parameters and importing/exporting configuration files.
- Remote Serial Port Control: Configuring settings for RS-232 and RS-485 ports.
- Remote Video Output Control: Sending remote button control signal.
- Two-way Audio: Two-way audio between the remote client and the DVR.
- Remote Alarm Control: Remotely arming (notify alarm and exception message to the remote client) and controlling the alarm output.
- Remote Advanced Operation: Remotely operating HDD management (initialising HDD, setting HDD property), upgrading system firmware, clearing I/O alarm output.
- Remote Shutdown/Reboot: Remotely shutting down or rebooting the DVR.

Camera Configuration

- Remote Live View: Remotely viewing live video for the selected camera(s).
 - Local Manual Operation: Locally start/stopping manual recording and alarm output of the selected camera(s).
 - Remote Manual Operation: Remotely starting/stopping manual recording and alarm output of the selected camera(s).
 - Local Playback: Locally playing back recorded files of the selected camera(s).
 - Remote Playback: Remotely playing back recorded files of the selected camera(s).
 - Local PTZ Control: Locally controlling PTZ movement of the selected camera(s).
 - Remote PTZ Control: Remotely controlling PTZ movement of the selected camera(s).
 - Local Video Export: Locally exporting recorded files of the selected camera(s).
7. Click the **OK** button to save the settings and exit interface.

Only the *admin* user account has the permission for restoring factory default parameters.

12.5.2 Deleting a User

Steps:

1. Enter the User Management interface.
Menu > Setup > User
2. Select the user to be deleted from the list.

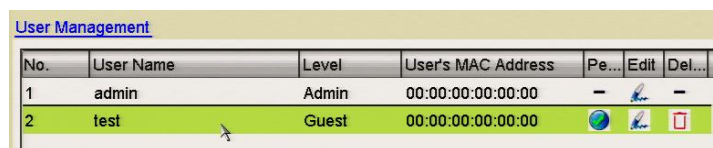

No.	User Name	Level	User's MAC Address	Pe...	Edit	Del...
1	admin	Admin	00:00:00:00:00:00	-		-
2	test	Guest	00:00:00:00:00:00			

Figure 12.5.2.1 Delete a User

3. Click the  icon to delete the selected user.

12.5.3 Editing a User

Steps:

1. Enter the User Management interface.
Menu > Setup > User
2. Select the user to be edited from the list.

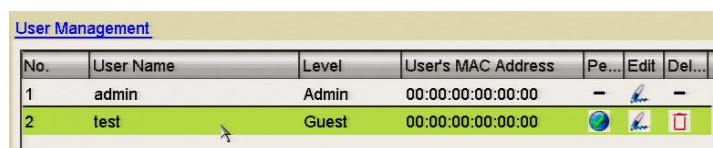





No.	User Name	Level	User's MAC Address	Pe...	Edit	Del...
1	admin	Admin	00:00:00:00:00:00	-		-
2	test	Guest	00:00:00:00:00:00			

Figure 12.5.3.1 Edit a User

3. Click the  icon to enter the Edit User interface.

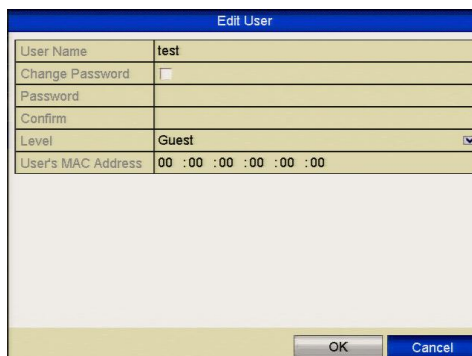

Edit User	
User Name	test
Change Password	<input type="checkbox"/>
Password	
Confirm	
Level	Guest
User's MAC Address	00 :00 :00 :00 :00 :00

Figure 12.5.3.2 Edit User Interface - operator and guest

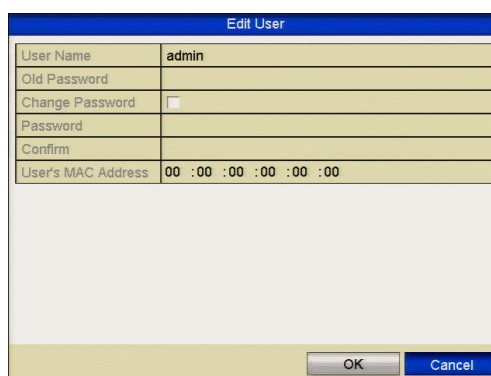

Edit User	
User Name	admin
Old Password	
Change Password	<input type="checkbox"/>
Password	
Confirm	
User's MAC Address	00 :00 :00 :00 :00 :00

Figure 12.5.3.3 Edit User Interface - admin

4. Edit the parameters.

- **Operator and Guest**

You can edit the user information, including user name, password, permission level and MAC address. Click the **Change Password** box if you want to change the password and input the new one in the text field of **Password** and **Confirm**.

- **Admin**

You are only allowed to edit the password and MAC address. Click the **Change Password** box if you want to change the password, input the old password and enter the new one in the **Password** text field and **Confirm**.

5. Click the **OK** button to save the settings and exit the interface.

Chapter 13 Glossary

- **Dual Stream:** Dual stream is a technology used to record high resolution video locally while transmitting a lower resolution stream over the network. The two streams are generated by the DVR, with the main stream having a maximum resolution of 1080P and the sub-stream having a maximum resolution of CIF.
- **DVR:** Acronym for Digital Video Recorder. A DVR is device that is able to accept video signals from analog cameras, compress the signal and store it on its hard drives.
- **HDD:** Acronym for Hard Disk Drive. A storage medium which stores digitally encoded data on platters with magnetic surfaces.
- **DHCP:** Dynamic Host Configuration Protocol (DHCP) is a network application protocol used by devices (DHCP clients) to obtain configuration information for operation in an Internet Protocol network.
- **HTTP:** Acronym for Hypertext Transfer Protocol. A protocol to transfer hypertext request and information between servers and browsers over a network
- **PPPoE:** PPPoE, Point-to-Point Protocol over Ethernet, is a network protocol for encapsulating Point-to-Point Protocol (PPP) frames inside Ethernet frames. It is used mainly with ADSL services where individual users connect to the ADSL transceiver (modem) over Ethernet and in plain Metro Ethernet networks.
- **DDNS:** Dynamic DNS is a method, protocol, or network service that provides the capability for a networked device, such as a router or computer system using the Internet Protocol Suite, to notify a domain name server to change, in real time (ad-hoc) the active DNS configuration of its configured hostnames, addresses or other information stored in DNS.
- **Hybrid DVR:** A hybrid DVR is a combination of a DVR and NVR.
- **NTP:** Acronym for Network Time Protocol. A protocol designed to synchronise the clocks of computers over a network.
- **NTSC:** Acronym for National Television System Committee. NTSC is an analogue television standard used in such countries as the United States and Japan. Each frame of an NTSC signal contains 525 scan lines at 60Hz.
- **NVR:** Acronym for Network Video Recorder. An NVR can be a PC-based or embedded system used for centralised management and storage for IP cameras, IP Domes and other DVRs.
- **PAL:** Acronym for Phase Alternating Line. PAL is also another video standard used in broadcast televisions systems in the UK and large parts of the world. PAL signal contains 625 scan lines at 50Hz.
- **PTZ:** Acronym for Pan, Tilt, Zoom. PTZ cameras are motor driven systems that allow the camera to pan left and right, tilt up and down and zoom in and out.
- **USB:** Acronym for Universal Serial Bus. USB is a plug-and-play serial bus standard to interface devices to a host computer.

Chapter 14 Troubleshooting

- **No image displayed on the monitor after the device boots up normally.**

Possible Reasons:

- a) No VGA or HDMI connections.
- b) Connection cable is damaged.
- c) Input mode of the monitor is incorrect or DVR resolution is set higher than the monitor.

Steps:

1. Verify the device is connected to the monitor via HDMI or VGA cable. A composite output is available on some DVR models. Only connect one video cable. Then reboot the DVR to self detect. (The DVR menu (Setup – General – Menu Output Mode) is set to Auto which is self detect, by default)
2. Verify the connection cable is good.
If there is still no image displayed on the monitor after rebooting, please check the cable, or replace and connect again.
3. Verify Input mode of the monitor is correct.
Please check the input mode of the monitor matches with the output mode of the device (e.g. if the output mode of DVR is HDMI output, then the input mode of monitor must be the HDMI input). If not, please modify the input mode of monitor.

- **There is a beeping sound after a new DVR starts up.**

Possible Reasons:

- a) No HDD is installed in the device.
- b) The installed HDD has not been initialised.
- c) The installed HDD is not compatible with the device or is faulty.

Steps:

1. Verify at least one HDD is installed in the device.
 - 1) If not, please install a compatible HDD.
 - 2) If you do not want to install an HDD, select “Menu>Setup> Exceptions” and unclick the Audible Warning checkbox for “HDD Error”.
2. Verify the HDD is initialised.
 - 1) Select “Menu>Drives>General”.
 - 2) If the status of the HDD is “Uninitialised”, please click the checkbox of corresponding HDD and click the “Format” button.
3. Verify the HDD is detected or is in good condition.
 - 1) Select “Menu>Drives>General”.
 - 2) If the HDD is not detected or the status is “Abnormal”, please replace the dedicated HDD according to the requirement.

- **Live view pictures not fluent**

Possible Reasons:

- a) The frame rate is not set to 25fps real-time frame rate.

Steps:

1. Check the parameters of Main Stream (Normal) and Main Stream (Event).
Select “Menu > Video > Encoding > Record”, and set the resolution of Main Stream (Event) the same as the one of Main Stream (Normal).
2. Verify the frame rate is real-time frame rate.
Select “Menu > Video > Encoding > Record”, and set the Frame rate to Full Frame.

- **When using the device to get the live view audio, there is no sound or there is too much noise, or the volume is too low.**

Possible Reasons:

- a) Cable between the audio device and DVR is not connected correctly, there are impedance mismatches or incompatibilities.
- b) The stream type in the DVR menu is not set to “Video & Audio”.

Steps:

1. Verify the cable between the audio unit and DVR is connected correctly, impedance matches and they are compatible.
2. Verify the setting parameters are correct.
Select “Menu > Video > Encoding > Record” and set the Stream Type as “Audio & Video”.

- **No record file found on the DVR local HDD and the prompt “No record file found” displays when you search for recorded files.**

Possible Reasons:

- a) The time setting is incorrect.
- b) The search condition is incorrect.
- c) The HDD is in error or not detected.

Steps:

1. Verify the system time setting is correct.
Select “Menu > Setup > General ” and verify the “Device Time” is correct.
2. Verify the search condition is correct.
Select “Playback”, and verify the channel and time are correct.
3. Verify the HDD status is normal.
Select “Menu > Drives > General” to view the HDD status, and verify the HDD is detected and can be read and written normally.

Chapter 15 Record Timings

15.1 Record Timings for 4 channels - MEGA204

CIF mode

Frame Rate	HDD 500Gb	HDD 1.0Tb	HDD 2.0Tb	HDD 3.0Tb	HDD 4.0Tb
25	20dy 14hr	41dy 5hr	82dy 10hr	123dy 15hr	164dy 20hr
12	41dy 5hr	82dy 10hr	164dy 20hr	247dy 6hr	329dy 16hr
6	82dy 10hr	164dy 21hr	329dy 18hr	494dy 15hr	659dy 8hr
4	109dy 22hr	219dy 20hr	439dy 17hr	659dy 13hr	879dy 10hr
2	219dy 20hr	439dy 17hr	879dy 10hr	1319dy 3hr	1758dy 20hr
1	439dy 17hr	879dy 10hr	1319dy 3hr	2198dy 13hr	2638dy 6hr

2CIF mode

Frame Rate	HDD 500Gb	HDD 1.0Tb	HDD 2.0Tb	HDD 3.0Tb	HDD 4.0Tb
25	10dy 7hr	20dy 14hr	41dy 5hr	61dy 19hr	82dy 10hr
12	20dy 14hr	41dy 5hr	82dy 10hr	123dy 15hr	164dy 21hr
6	41dy 5hr	82dy 10hr	164dy 21hr	247dy 7hr	329dy 18hr
4	54dy 23hr	109dy 22hr	219dy 20hr	329dy 18hr	439dy 17hr
2	109dy 22hr	219dy 20hr	439dy 17hr	659dy 13hr	879dy 10hr
1	219dy 20hr	439dy 17hr	879dy 10hr	1319dy 3hr	1758dy 20hr

4CIF mode

Frame Rate	HDD 500Gb	HDD 1.0Tb	HDD 2.0Tb	HDD 3.0Tb	HDD 4.0Tb
25	5dy 4hr	10dy 7hr	20dy 14hr	30dy 21hr	41dy 5hr
12	10dy 7hr	20dy 14hr	41dy 5hr	64dy 19hr	82dy 10hr
6	20dy 15hr	41dy 5hr	82dy 10hr	123dy 15hr	164dy 21hr
4	27dy 12hr	54dy 23hr	109dy 22hr	164dy 21hr	219dy 20hr
2	54dy 23hr	109dy 22hr	219dy 20hr	329dy 18hr	439dy 17hr
1	109dy 22hr	219dy 20hr	439dy 17hr	659dy 13hr	879dy 10hr

720P mode

Frame Rate	HDD 500Gb	HDD 1.0Tb	HDD 2.0Tb	HDD 3.0Tb	HDD 4.0Tb
25	2dy 14hr	5dy 4hr	10dy 8hr	15dy 12hr	20dy 16hr
12	5dy 4hr	10dy 8hr	20dy 16hr	31dy	41dy 7hr
6	10dy 8hr	20dy 16hr	41dy 7hr	61dy 23hr	82dy 15hr
4	13dy 18hr	27dy 13hr	55dy 2hr	82dy 15hr	110dy 4hr
2	27dy 13hr	55dy 2hr	110dy 4hr	165dy 5hr	220dy 7hr
1	41dy 7hr	82dy 15hr	165dy 5hr	247dy 20hr	330dy 11hr

1080P mode

Frame Rate	HDD 500Gb	HDD 1.0Tb	HDD 2.0Tb	HDD 3.0Tb	HDD 4.0Tb
25	1dy 1hr	2dy 2hr	4dy 3hr	6dy 5hr	8dy 6hr
12	2dy 2hr	4dy 3hr	8dy 6hr	12dy 9hr	16dy 12hr
6	4dy 3hr	8dy 6hr	16dy 12hr	24dy 19hr	33dy 1hr
4	5dy 12hr	11dy	22dy	33dy 1hr	44dy 1 hr
2	11dy	22dy	44dy 1hr	66dy 2hr	88dy 3hr
1	16dy 12hr	33dy	66dy 2hr	99dy 3hr	132dy 4hr

15.2 Record Timings for 8 channels - MEGA208

CIF mode

Frame Rate	HDD 500Gb	HDD 1.0Tb	HDD 2.0Tb	HDD 3.0Tb	HDD 4.0Tb
25	10dy 7hr	20dy 14hr	41dy 4hr	61dy 18hr	82dy 8hr
12	20dy 14hr	41dy 5hr	82dy 10hr	123dy 15hr	164dy 20hr
6	41dy 5hr	82dy 10hr	164dy 20hr	247dy 6hr	329dy 16hr
4	54dy 23hr	109dy 22hr	219dy 20hr	329dy 20hr	439dy 16hr
2	109dy 22hr	219dy 20hr	439dy 16hr	659dy 12hr	879dy 8hr
1	164dy 21hr	329dy 18hr	659dy 12hr	989dy 6hr	1319dys

2CIF mode

Frame Rate	HDD 500Gb	HDD 1.0Tb	HDD 2.0Tb	HDD 3.0Tb	HDD 4.0Tb
25	5dy 3hr	10dy 7hr	20dy 14hr	30dy 21hr	41dy 4hr
12	10dy 7hr	20dy 14hr	41dy 5hr	61dy 19hr	82dy 10hr
6	20dy 14hr	41dy 5hr	82dy 10hr	123dy 15hr	164dy 20hr
4	27dy 11hr	54dy 23hr	109dy 22hr	164dy 21hr	219dy 20hr
2	54dy 23hr	109dy 22hr	219dy 20hr	329dy 18hr	439dy 16hr
1	82dy 10hr	164dy 21hr	329dy 18hr	494dy 15hr	659dy 12hr

4CIF mode

Frame Rate	HDD 500Gb	HDD 1.0Tb	HDD 2.0Tb	HDD 3.0Tb	HDD 4.0Tb
25	2dy 14hr	5dy 3hr	10dy 7hr	15dy 10hr	20dy 14hr
12	5dy 3hr	10dy 7hr	20dy 14hr	30dy 21hr	41dy 5hr
6	10dy 7hr	20dy 14hr	41dy 5hr	61dy 19hr	82dy 10hr
4	20dy 14hr	27dy 11hr	54dy 23hr	82dy 10hr	109dy 22hr
2	27dy 11hr	54dy 23hr	109dy 22hr	164dy 21hr	219dy 20hr
1	54dy 23hr	82dy 10hr	164dy 21hr	247dy 7hr	329dy 18hr

720P mode

Frame Rate	HDD 500Gb	HDD 1.0Tb	HDD 2.0Tb	HDD 3.0Tb	HDD 4.0Tb
25	1dy 7hr	2dy 14hr	5dy 4hr	7dy 18hr	10dy 8hr
12	2dy 14hr	5dy 4hr	10dy 8hr	15dy 12hr	20dy 16hr
6	5dy 4hr	10dy 8hr	20dy 16hr	30dy 23hr	41hr 8hr
4	6dy 21hr	13dy 18hr	27dy 13hr	41dy 7hr	55dy 2hr
2	13dy 18hr	27dy 13hr	55dy 2hr	82dy 15hr	110dy 4hr
1	20dy 16hr	41dy 7hr	82dy 15hr	123dy 21hr	165dy 5hr

1080P mode

Frame Rate	HDD 500Gb	HDD 1.0Tb	HDD 2.0Tb	HDD 3.0Tb	HDD 4.0Tb
25	12hr	1dy	2dy 2hr	3dy 2hr	4dy 3hr
12	1dy	2dy 2hr	4dy 3hr	6dy 5hr	8dy 6hr
6	2dy 2hr	4dy 3hr	8dy 6hr	12dy 9hr	16dy 12hr
4	2dy 18hr	5dy 12hr	11dy	16dy 12hr	22dy
2	5dy 12hr	11dy	22dy	33dy 1hr	44dy 1hr
1	8dy 6hr	16dy 12hr	33dy 1hr	49dy 14hr	66dy 2hr

15.3 Record Timings for 16 channels - MEGA216/MAX316/416

CIF mode

Frame Rate	HDD 500Gb	HDD 1.0Tb	HDD 2.0Tb	HDD 3.0Tb	HDD 4.0Tb
25	5dy 3hr	10dy 7hr	20dy 14hr	30dy 21hr	41dy 4hr
12	10dy 7hr	20dy 14hr	41dy 5hr	61dy 18hr	82dy 10hr
6	20dy 14hr	41dy 5hr	82dy 10hr	123dy 15hr	164dy 20hr
4	27dy 11hr	54dy 23hr	109dy 22hr	164dy 21hr	219dy 20hr
2	54dy 23hr	109dy 2hr	219dy 20hr	327dy 6hr	439dy 16hr
1	82dy 10hr	164dy 1hr	329dy 18hr	492dy 3hr	759dy 12hr

2CIF mode

Frame Rate	HDD 500Gb	HDD 1.0Tb	HDD 2.0Tb	HDD 3.0Tb	HDD 4.0Tb
25	2dy 14hr	5dy 3hr	10dy 7hr	15dy 11hr	20dy 14hr
12	5dy 3hr	10dy 7hr	20dy 14hr	30dy 22hr	41dy 5hr
6	10dy 7hr	20dy 14hr	41dy 5hr	61dy 20hr	82dy 10hr
4	13dy 16hr	27dy 11hr	54dy 23hr	82dy 10hr	109dy 22hr
2	27dy 11hr	54dy 23hr	109dy 22hr	164dy 21hr	219dy 20hr
1	54dy 23hr	82dy 10hr	164dy 21hr	247dy 8hr	329dy 18hr

4CIF mode

Frame Rate	HDD 500Gb	HDD 1.0Tb	HDD 2.0Tb	HDD 3.0Tb	HDD 4.0Tb
25	1dy 7hr	2dy 14hr	5dy 3hr	7dy 17hr	10dy 6hr
12	2dy 14hr	5dy 3hr	10dy 7hr	15dy 10hr	20dy 14hr
6	5dy 3hr	10dy 7hr	20dy 14hr	30dy 22hr	41dy 5hr
4	6dy 20hr	20dy 14hr	27dy 11hr	41dy 5hr	54dy 23hr
2	13dy 16hr	27dy 11hr	54dy 23hr	82dy 10hr	109dy 22hr
1	27dy 8hr	54dy 23hr	82dy 10hr	123dy 16hr	164dy 21hr

720p mode

Frame Rate	HDD 500Gb	HDD 1.0Tb	HDD 2.0Tb	HDD 3.0Tb	HDD 4.0Tb
25	16hr	1dy 7hr	2dy 14hr	3dy 21hr	5dy 4hr
12	1dy 7hr	2dy 14hr	5dy 4hr	7dy 18hr	10dy 8hr
6	2dy 14hr	5dy 4hr	10dy 8hr	15dy 12hr	20dy 16hr
4	3dy 11hr	6dy 21hr	13dy 18hr	20dy 16hr	27dy 12hr
2	6dy 21hr	13dy 18hr	27dy 13hr	41dy 7hr	55dy 2hr
1	10dy 8hr	20dy 16hr	41dy 7hr	61dy 23hr	82dy 15hr

1080p mode

Frame Rate	HDD 500Gb	HDD 1.0Tb	HDD 2.0Tb	HDD 3.0Tb	HDD 4.0Tb
25	6hr	12hr	1dy	1dy 13hr	2dy 2hr
12	12hr	1dy	2dy 2hr	3dy 2hr	4dy 3hr
6	1dy	2dy 2hr	4dy 3hr	6dy 5hr	8dy 6hr
4	1dy 9hr	2dy 18hr	5dy 12hr	8dy 6hr	11dy
2	2dy 18hr	5dy 12hr	11dy	16dy 12hr	22dy
1	4dy 3hr	8dy 6hr	16dy 12hr	24dy 19hr	33dy 1hr