

Mini Hi-Speed Dome

Installation and Operation Manual

PTZ280

For Internal or External Use



12vDC

Run Tours

Autoscans

Patterns

Plus On Screen Menu

Version 1.0

CONTENTS TABLE

Description	Page No.
Contents	2
Safety Precautions	4
Description of Functions	5
Integrated Multi-Protocol Decoder	5
Integrated Speed – Variable PAN/TILT	5
High Intelligent Settings	5
Modify Dome Address by RS485	6
Setting Protocol and Baud Rate	6
Getting the dome up & running	6
Overview – introduction to fitting PTZ equipment	7
RS485 Wiring methods & Tips	9
Characteristics of RS485	9
Transmission distances of RS485 signals using CAT5	9
RS485 Connection Methods	9
Daisy Chain Connection	9
Star method of connection	10
Overcoming RS485 data loss using an RS485 distributor	11
Setting up the Dome Camera	13
RS485 connection – Connecting the Keypad or DVR to the Dome	14
Connecting the video out of the dome	16
If you are using more than one dome on a site	18
Setting up a unique address in a dome	18
Entering the address in the menu	19
Setup of the Protocol and the Default Baud Rate	19
Using the PTZ730 keypad with the excelPTZ series	20
Presets and other functions	21
PRESETS - How to set up a preset	21
Patrols (Tours) – How to set them up and use them	21
Deleting a preset	22
Setting the Patrol (Tour)	22
Calling the Patrol (Tour)	23
AUTO SCAN – How to set it up	24
Calling the Auto Scan	24
RECORD PATTERN – What is a record pattern	25
RECORD PATTERN – Difference between a patrol	25
RECORD PATTERN – How to set it up	25
Running the Record Pattern	26
Using the Dome’s Advanced Functions	27
Using the Menu System	28
System Setup	29
Display Setup	30
Camera Setup	31

	Motion Setup	33
	Presets	33
	Auto Scan	33
	Patrols	34
	Patterns	35
	Clear	35
Privacy Mask		36
Advance Setup		37
	Home Setup	37
	Password	38
	CAM ID Setup	38
	Fan Control	39
	Language	40
	Set North Position	40
System Reset		40
Controlling one camera then another		41
System Installation		42
Technical Specification		43
Appendix A: General Information		44
Troubleshooting		44

Please read this operation manual carefully
before installing and using this unit !!!!



Please read the following;

1. Please read the operation manual carefully before installing and operating the product.
2. The actual dome requires a **12v DC regulated power supply**. The rated input voltage of the camera is 12V. This gets its power from the dome and does not require a separate PSU. Do not connect 24V AC to the PTZ under any circumstances!!
3. During the course of transportation, storage and installation, the product should be handled with care avoiding vibration and any weight pressure, which may cause damage to the sophisticated optical and electronic equipment inside the machine.
4. Do not attempt to disassemble the camera. In order to prevent electric shock, do not remove screws or covers. There are no user-serviceable parts inside the camera.
5. Always use and stick to current electrical safety standards to install and use the dome. Use a correctly rated power supply. The RS-485 and video signal cables should be kept way from other high voltage equipment such as mains cables and especially fluorescent lights. Using an anti surge protection device is recommended to prevent damage to the domes from lightning and mains surges. Damage to domes by lightning or mains voltage surges is not covered under the dome warranty.
6. Do not operate in areas exceeding the stipulated limitations concerning temperature, humidity and power supply.
7. Do not aim the camera directly towards the sun or an extreme light source whether it is switched on or not. Do not let the camera focus on bright and stationary objects for a long time. Doing either of these may damage the camera.
8. Do not use strong detergents to clean the main body of the camera as these may damage the dome cover or paintwork. Wipe dirt with dry cloth. If needed a *mild* detergent can be used.
9. Operate the dome camera with great care to avoid shock or vibration. If operated incorrectly, the Dome could be damaged.
10. Ensure the dome is not dropped. Never mount the unit on a ceiling that cannot support its weight.
11. If necessary, use a commercial lens cleaning paper to clear the lens windows. Gently wipe the lens window until clean.

Description of Functions

This intelligent dome camera is a hi-tech CCTV product, which incorporates a high-clarity colour camera. It has a panoramic variable speed PAN/TILT movement, a multifunctional decoder, a character generator and an on-board processor for logic handling. The dome is easy to connect, install, maintain and operate, and has many features. The dome is compact and has a strong structure with a modern and appealing appearance.

1. Integrated Multi-Protocol Decoder

- a. The integrated multifunctional decoder can communicate with 16 different protocols. The baud rate can be independently set allowing compatibility with numerous systems with selectable baud rates from 2400 bps to 19200 bps. This dome uses RS485 serial control and can address from 1 to 255 cameras using binary addresses. Note that this camera uses software settings to set the Protocol, Baud Rate and ID.

2. Integrated Speed-Variable PAN/TILT

- a. The dome can turn 360° horizontally and continuously with unlimited positions with an adjustable pan speed 120° per second and turning 0 - 90° vertically with a speed up to 90 rad/s.
- b. The dome can run at low speed, low noise, and does not show any picture shake.
- c. The dome has an automatic 180° flip facility and provides panoramic monitoring without any blind spots.
- d. This dome is a high precision unit and maintains preset positions up to $\pm 0.1^\circ$.

3. High Intelligent Settings

- a. This dome can store up to 128 preset positions in non-volatile memory that are not lost with a power failure. Refer to the section "Presets and other functions."
- b. The dome can scan horizontally between two points and the scan speed can be modified. The dome can scan a range larger or smaller than 180° between any two points with adjustable speed settings. Refer to the section on "Auto Scan."
- c. Six sets of tours (patrols) each with 16 preset positions can be programmed. The dwell times are adjustable. Refer to the section on "Patrols (Tours)."
- d. The dome camera can simulate a route operated by you within a 120 second interval by utilising the Record Pattern facility. Refer to the section on "Record Pattern."
- e. Proportional pan function. The dome travel speed will depend upon the extent of the zoom coverage. In telephoto zoom mode, the pan and tilt speeds will be slower for a given amount of joystick movement than that in wide zoom mode. This keeps the image from moving too fast on the monitor when there is a large amount of zoom coverage. This slowing down does not occur when going to a preset, but does occur in turbo mode when the high speed zoom is selected. The minimum pan and tilt speeds are 0.1 degree per second at full zoom.
- f. Password Function. Allows access to the menu to be password protected.
Default = 111111

- g. Angle Display. Three options for displaying camera angle settings.
- h. Software Modify the Dome Address. Allows dome address to be changed through RS485 software (ID Change in Advance Settings)
- i. Returns to last position. If unit loses power, when re-powered it can be set to return after the self test to the position that it was at, when power was lost.
- j. Temperature Display. Allows the display of dome temperature so that it can be adjusted.

4. **Modify Dome Address by RS485**

The Dome ID address is set in the menu. This address by default is set to 001. If this needs to be changed then access the ADVANCE SETTING menu and select ID CHANGE menu. Input camera serial number and then set the new ID to a three character field.

5. **Setting Protocol and Baud Rate**

This dome has no dipswitches for setting the protocol or baud rate. Changes are made in the menu only. The internal protocol is set to PELCO-P/D (P003) by default and 2400BPS baud rate. If these need changing then access the SYSTEM SETTING menu, then select COMM SETUP to change to Protocol and Baud Rate.

Getting the dome up and running!



You MUST connect up the dome and your control equipment on a workbench or kitchen table before the actual site installation and CHECK YOU KNOW HOW TO INSTALL IT CORRECTLY!!!!!!!!!!!!!!!!!!!!!!.

By doing this you can set-up camera addresses, protocols, baud rate, adjust the camera and learn about how it operates before taking it to site. This will save you hours of time on-site trying to work out why a particular item doesn't function as you expected it to. There is nothing worse than installing something and then having to take it down to see how to get it working!! Do the learning curve in the comfort of your own premises!!!!

SPECIAL NOTE: THIS PTZ HAS NO DIPSWITCHES AND IF YOU NEED TO INSTALL MORE THAN ONE UNIT CONTROLLED BY A KEYPAD OR DVR, YOU MUST CHANGE THE ID NUMBER IN THE MENU. AS BOTH UNITS WILL HAVE IDENTICAL ADDRESSES OF 001, EACH UNIT IS UNIQUELY IDENTIFIED BY THE CAMERA SERIAL NUMBER. IN ORDER TO ACCESS THE CORRECT PTZ AND CHANGE THE ID, YOU MUST FIRST ENTER THE CAMERA SERIAL NUMBER.

**Do you KNOW how to install PTZ equipment that is controlled by RS485 data signals?
If not please read the following introduction to PTZ >>>....**

Overview- introduction to fitting PTZ equipment

Generally speaking, PTZ Domes requires four things;

- 1- They require a power supply and a cable to supply this power to the dome. Often, external domes are 24V A.C **but this mini pan is 12V DC.**
- 2- They require a cable to get the video signal back to the monitor or recording device.
- 3- They require a cable to transmit the “RS485 control signal” from the keypad or DVR to tell the dome to pan, tilt and zoom etc.
- 4- They require something to control them, either a keypad or a DVR.

The following diagram indicates the basic cable requirements for a PTZ system.

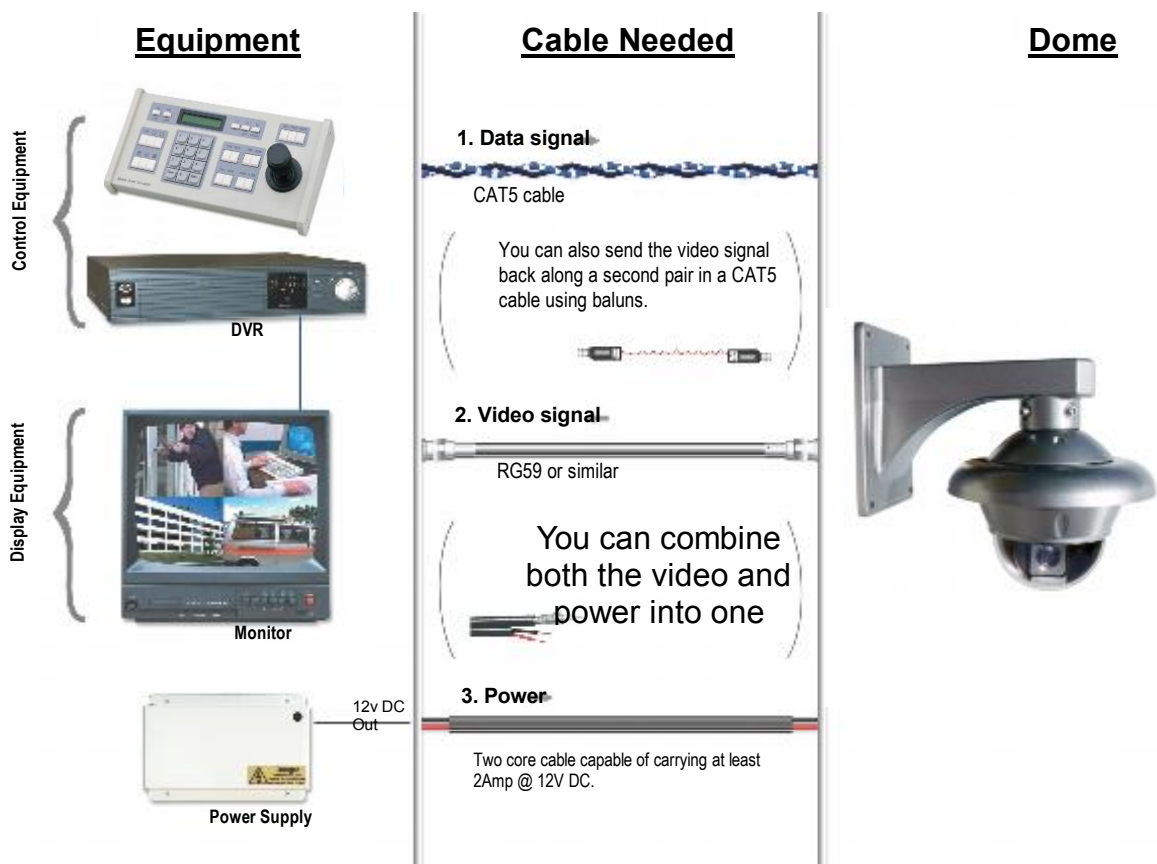

You can get “composite” cables that will carry both the power and the video signals and this has the benefit of combining two of the three cables into one. You may choose to power the dome locally to it, so you may only need to get the video signal back from the dome and the RS485 control signals to it. If this is the case you may choose to use a pair of BALUNS. By using baluns you can send the video signal and control signal down the same CAT5 cable just using different cores for each signal.

The control signal (RS485) is nearly always sent along a “twisted-pair” type cable. The twists in the cable help prevent interference affecting the data signal by “shielding” it. Many

installation companies use a CAT5 type or similar cable to run out to the domes to carry the data signal.

If you are considering using baluns please note - DVR's tend to require very good video signals to function correctly and "passive baluns" can lose some signal strength over the 50 metre mark so try to restrict the use of passive baluns to below 50 metre cable runs when using them with DVRs. Above this distance perhaps consider an active balun. Active baluns require power, passive baluns do not.

You can mix and match how you wire up your PTZ installation and the following general diagram gives you a guideline about how to do it. Remember this is a GUIDE and is not an instruction what to fit!

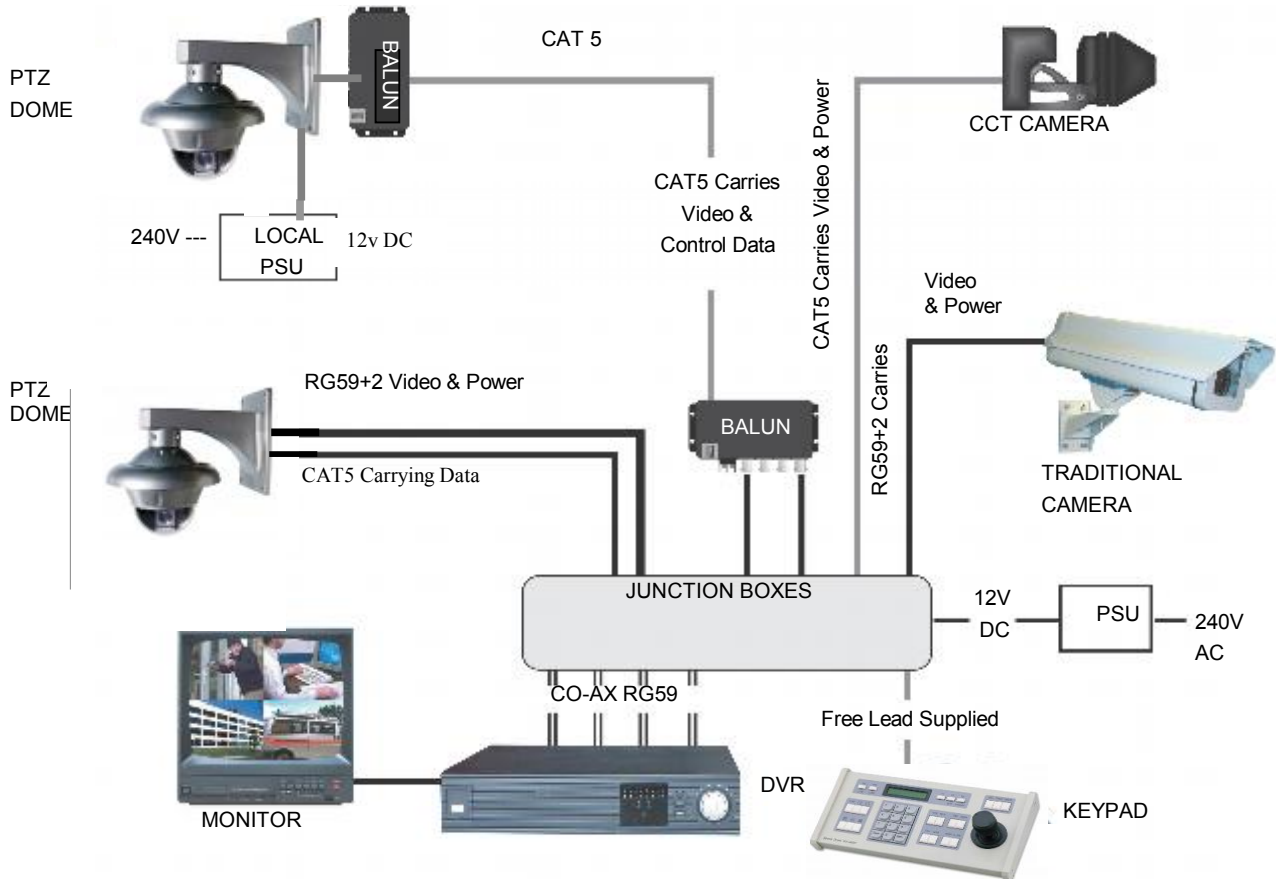

Many installation companies can get the power and video signal correct, but struggle with the control of the dome using the keypad or DVR using the RS485 data.

The key to successfully installing the data cabling to the dome is to get the basics right. Use a quality data cable such as CAT5 (never use just a standard untwisted cable such as alarm cable for the RS485 signal).

Also, you must follow the RS485 wiring convention; the following section explains this.

RS485 Wiring methods & Tips >>>>>

1. Characteristics of RS485

As specified by RS485 standards, RS485 is a half-duplex data transmission type with characteristic impedance of 120Ω . The maximum load capacity is 32 units (domes, keyboards and DVRs).

2. Transmission distances of RS485 Signals using CAT5 or similar cables

Selecting a CAT5 or similar sized twisted pair data transmission cable, the maximum theoretical transmitting distances are as follows:

Baud Rate	<u>Maximum</u> Transmitting Distance
2400 Bps (PELCO-D)	1500m
4800 bps	1000m
9600 bps	600m

PLEASE NOTE - Using inferior cables, or installing the dome in an environment with strong electromagnetic interference, or connecting a lot of PTZ domes to the same cable carrying the RS485 signal will reduce the maximum transmitting distance.

3. RS485 Connection methods

METHOD 1 – DAISY CHAIN CONNECTION.

The general RS485 standard recommends a “daisy chain” connection of equipment that is to be controlled. This means that the control cable is looped out of the one dome to the next dome and so on. The last dome in the line is then fitted with what is known as a “termination resistor”. This has a value of 120Ω .

The resistor is built in the PTZ domes and is activated by moving the appropriate “jumper” in the dome. The keyboard itself generally has a built-in 120Ω resistor. These termination resistors help make the signal more stable and give the system better reliability so the domes function as expected. A common mistake installer’s make is not making sure the 120Ω resistor is switched ON in the LAST dome. Also installers often select the resistor to ON in another dome in the chain, these errors will make control of the dome unpredictable.

A simplified Daisy chain is shown below;

This first diagram shows the cables looping in one dome and out of another;

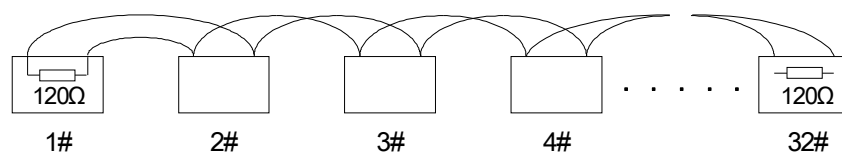

Standard Daisy-Chain connection for the RS485 PTZ control signal

(just the last dome only has the 120Ω resistor set to on, the first device is the keyboard and has the 120Ω built in as default)

This next diagram is a slight variation on the Daisy Chain arrangement. Again it's one cable going out to all the domes but instead of the cable going into each dome then back out to the next one, a junction box is used to "Spur-Off" to each dome. Whilst this can be done THE SPUR LENGTH (D) must be NO MORE THAN 10 metres!!!!!! The overall cable length between the Controller and the last dome is limited to around 300 metres in such an arrangement.

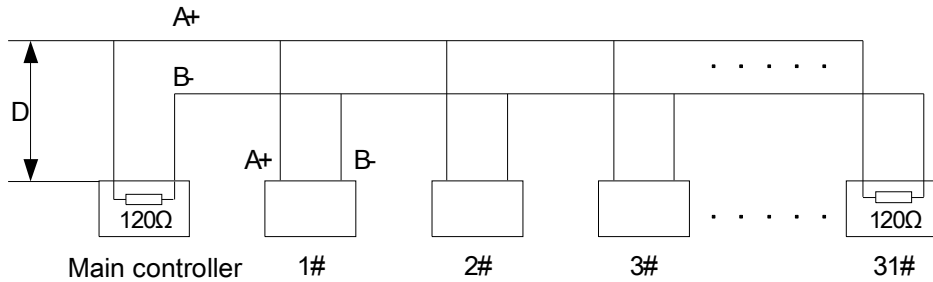

Daisy-Chain connection WITH SHORT SPURS for the RS485 PTZ control signal

(one main radial with very short spurs to each dome off it, keeping the spurs to less than 10 meters)

TIP - The connection of a 120Ω termination resistor: The termination resistor is ready fitted on the domes pcb, all you have to do set it is move the jumper from Pins 2 & 3 to pins 1 & 2.

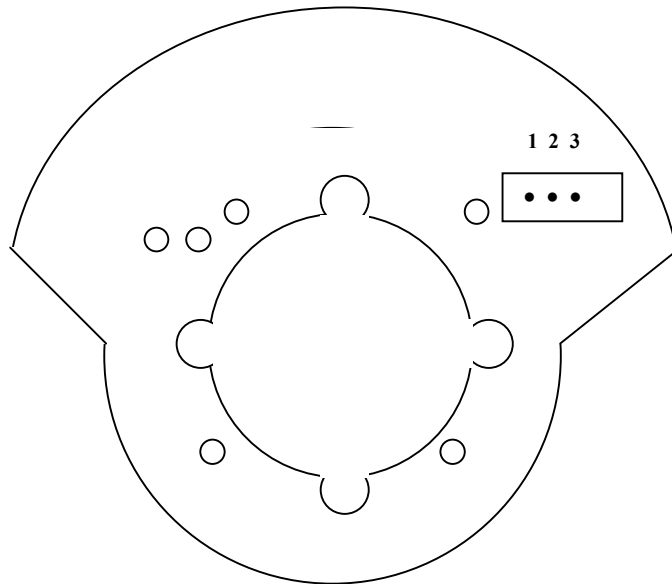

STAR method of connection.

In some circumstances you may need to adopt a star configuration for practical purposes. For instance, all the domes may be so scattered on a large site that running out separate spurs to each dome in a "STAR" array is the only practical solution.

So how do you do this in practice?

The termination resistors must be connected to the two domes that are furthest away from each other, such as domes 3 and 5 in the following “Star diagram”. Note that all the other domes do not have the 120ohm resistor connected. The resistors are already fitted to the domes PCB but by default are not in circuit. To put them in circuit you must move the small “jumper” as previously indicated.

As the star configuration is not in conformity with the requirements of RS485 standards, problems such as signal reflections may arise, especially when there are long cable connections. The results are that control signals are decreased and the dome may not respond to, or just responds intermittently to the controller.

If your STAR circuit is not too extensive with each spur in the region of 20-50 metres you can expect quite good reliable performance using this technique. If you experience any problems though, there is a RS485 distribution box available CODE PT750 to help overcome any problems.

The Star circuit for wiring PTZ's.
 The two furthest domes need the 120ohm resistors enabling, by moving the “Jumper”
In this example it's domes 3 & 5.

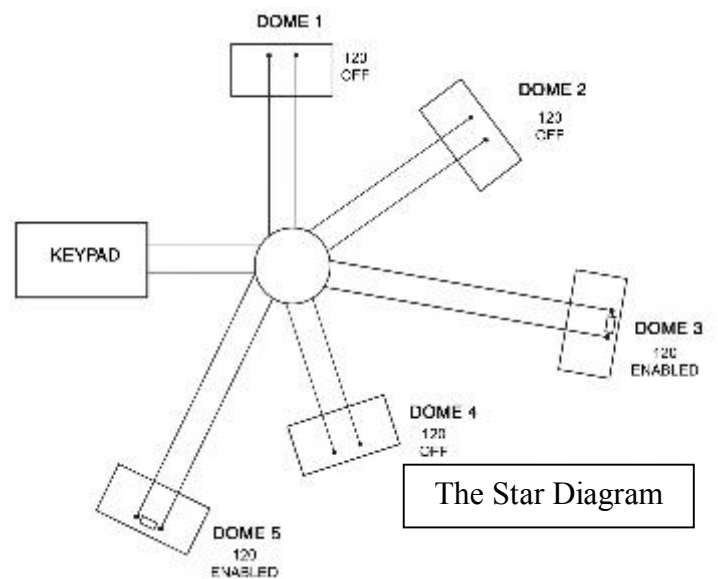

Overcoming RS485 data loss using an RS485 distributor

In the real world not everything always works exactly as it's expected to!

RS485 data signals that control the domes' movements are tiny signals that can get corrupted for many reasons. Poor cable quality, not using a PAIR of cores from a CAT5 but using one core from TWO separate pairs, running the CAT5 cable near mains equipment such as fluorescent lighting all will have a detrimental effect on the signal. These are things that you can correct with good installation practices.

Where you wish to run several separate CAT5 cables out to send the RS485 data signal out to the domes you are in effect correcting the STAR method of RS485 data distribution. As previously mentioned the problem with the Star method is that it is not actually designed for RS485 but generally works okay if you follow the previous notes on getting the 120ohm resistor setting right, as per the previous notes.

One way that takes the guesswork out of installing the Star method is to utilise an RS485 distributor. This has the advantage that the RS485 signal is correctly distributed to the domes so that they behave as expected. You can create up to 4 spurs to the domes and put up to 4 domes on each spur. Just like the Daisy chain method the end dome on each spur needs to have the 120ohm resistor enabled.

Although the RS485 distributor is a small additional expense, it takes some of the guess work out of the installation design and gives a more flexible approach to cabling which itself can save time and money on the installation. Not forgetting you get more predictable results!

The RS485 distributor (PTZ750) amplifies the RS485 control signal and distributes it evenly to 4 separate spurs, each spur can have up to 4 domes. This means that you could theoretically have up to 4 individual spurs of over 1000mtrs each to control up to 16 PTZ domes in total.

Ideally you would put just one dome on each spur from the PTZ750 but up to 4 domes is generally acceptable. The following diagram shows a typical use of the PTZ750 RS485 distributor.

In the following example and diagram, domes 1,4,5 and 7 are at the end of each spur and therefore require the 120ohm resistor enabling by moving the jumper setting within the domes. Domes 2,3 and 6 are all “midway” in each spur and do not need the 120ohm resistor and can be left as default. The PTZ750 itself has four 120ohm resistors built in as shown and you do not have to do anything with the PTZ750 as the resistors are permanently connected within it.

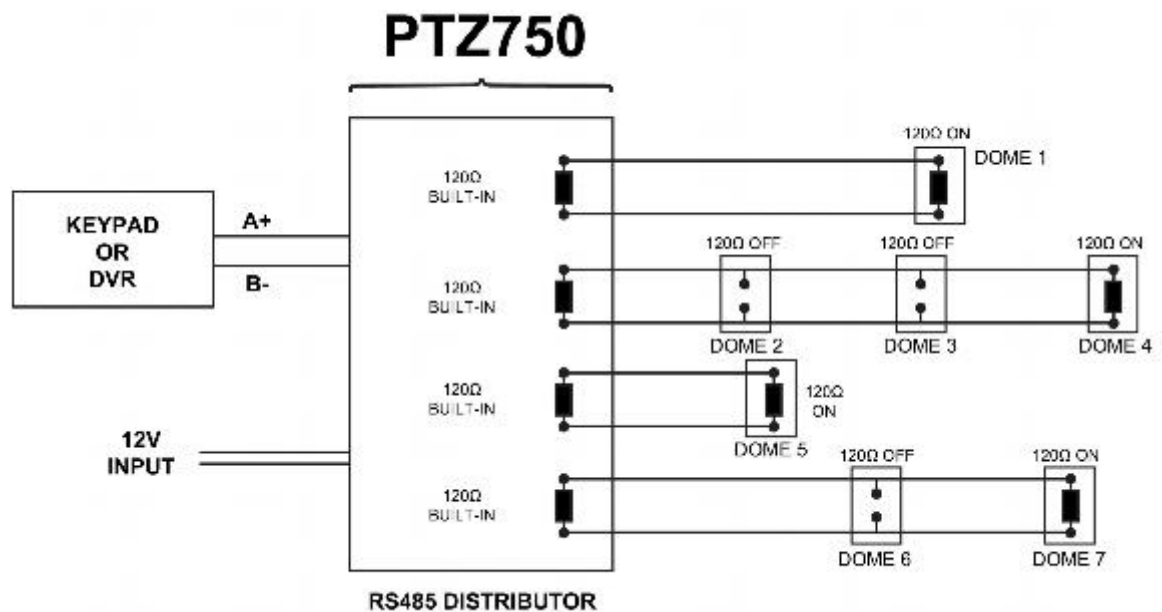

(Diagram showing how to use an RS485 distributor to improve PTZ control reliability)

Please note if you have the PTZ750 located within 5mtrs of the keypad or DVR you can connect up to 3 of them in parallel.



Figure 1.

Powering the domes-

All the domes will need power. For this dome it is a 12v DC regulated power supply. The power supply must be capable of delivering at least 1.7A per dome but it is advisable to allow some headroom so that the psu is not running flat out. **It is therefore recommended to use a 12v DC regulated psu with a minimum rating of 2Amps.**

You can either power each dome with its own PSU locally to it or have the PSU's remotely situated perhaps near the keyboard or DVR.

Please note - The domes heater doesn't come on until it senses the temperature drops below 0 degrees Celsius. Please make sure that you have a sufficient power supply and cable installed to cope with this. Obviously the dome may work okay in the summer but when winter kicks in and the dome's current draw jumps, an inadequate power supply or a cable with too much voltage drop may stop the dome from working properly. When winter comes don't be suddenly caught off guard when your customer rings you to say the dome has suddenly packed in because it's gone cold!!

A popular way to power the domes is using our COMPOSITE VIDEO cable (or shotgun as its also known) as this cable can carry the power to the dome and the video signal back to the monitor or DVR. Alternatively the COMBO cable also provides the RS485 data cable.

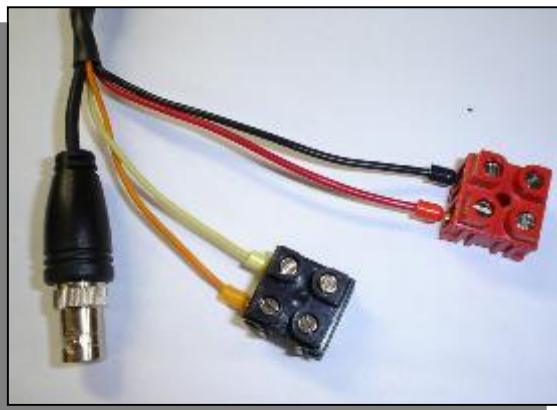

The power connection

The RED & BLACK cable coming out of the dome connected to the RED terminal block are for power. Connect a suitable 12v DC regulated power supply to this pair of cores.

The BNC connector is the "VIDEO-OUT" from the camera and goes to the monitor or "VIDEO-IN" of a DVR camera input.

The Orange and Yellow pair of cores that go in to the BLACK terminal block are the data cables. These are the cores that carry the RS485 control signal to the dome from either the keyboard or the DVR. The next section of the instructions gives more detail on how to connect the RS485 data. Please also read the RS485 WIRING METHODS & TIPS section towards the beginning of these instructions.

The distances for power cables are relatively short due to the high load of the dome when it starts up and using 12v DC. The maximum run would be less than 50 metres and if the voltage of the dome drops below 12v DC at the camera, it may fail to initialise. Obviously you can power the domes locally if you are able, which overcomes this issue.

RS485 connection - *Connecting the Keypad or DVR to the Dome.*



The dome is controlled by an RS485 data signal that is given by either a KEYPAD or a suitable DVR. This data signal tells the dome to pan, tilt, zoom etc. Its important that you read the early section of these instructions to understand the fundamental principle of RS485 cabling techniques so that you get it right.

RS485 has two cores, A and B or sometimes known as RS485 + (A) and RS485 - (B) if you get these two the wrong way around then you will not be able to control the dome. Sometimes installers get the connections right on one dome but not on the other and find only one dome works. They then swap the wires around at the keyboard only to find out one dome has now burst in to life and the other one now failed!! But they don't put 2 + 2 together and realise their mistake that they have wired one dome different to the other. Take great care getting these the right way around and make sure you wire each dome IDENTICALLY so

that if you have to swap the A & B lines over at the keyboard you know all domes are wired the same!!

The PTZ280 series adopts the following RS485 convention:

ORANGE = RS485 + or A
YELLOW = RS485 - or B



You should initially be wiring the dome to the keyboard or DVR on your workshop bench or at least your kitchen table to prove you know how to get everything to work. Once you have done this, it is just a job of extending the cables and physically installing the domes on site. You must obviously take note of the RS485 wiring techniques mentioned at the beginning of these instructions and get the 120ohm resistors correct in the “End of line” domes. Generally speaking you will always be extending the RS485 signal from either the keypad or the dome using a CAT5 or similar cable. **Note that data cables do not need to be connected through baluns.**

The PTZ730 and PTZ700 are two keypads that can be used with the PTZ280 series. On the rear of the keypads you will see the RS485 connections. Ensure they are connected correctly i.e the RS485 + A line and the RS485 - B line. Always connect to the **Transmit** and not the **Receive** connections. Note that both these keypads need to be set to the same protocol as the PTZ dome. Refer to the relevant keypad instruction manuals on the keypad dipswitch settings.



PTZ730



Rear of PTZ730

↑ ↑
RS485 connections



RS485 connections



PTZ700 keypad

Rear of PTZ700

If you use cores from two different pairs in the CAT5 cable you will not get the benefit of the shielding effect of the cable twists and the dome will function erratically. You must always use a core from a PAIR, not two cores from two different pairs!!

Connecting the video out of the dome.

The dome has a short BNC lead attached to it. This is the lead that carries the video signal from the built-in camera. You need to extend this lead to the “VIDEO-IN” of the DVR or monitor. Use a good quality RG59 coax cable or similar to do this.

TIP – If you can’t get a picture at the remote end you could always take your test monitor to your PTZ dome and check the picture quality on its own short BNC lead.

If you’re testing the equipment on a workbench you now have a one dome system.

For setting up the keyboard and testing the dome please read sections on default Dome settings and using the keyboard.

You can use a keyboard or a suitable DVR to control the dome. A suitable DVR would be one with PTZ functionality built into it and preferably Pelco-D protocol. If your DVR has a list of protocols it’s always best to try “Pelco-D” first. In the DVR, with Pelco-D set, you must also make sure you set up the “baud-rate” to 2400.

A typical site installation would look like the following diagram on the next page.

It shows the dome connected to the keypad plus how the dome could also be connected to a DVR instead of the keypad or at the same time. DVR’s that have the capabilities of PTZ control will have a terminal or connection on them somewhere, where the dome’s RS485+ A and RS485- B transmit line can connect to. Please refer to the individual DVR instructions of how to do this.

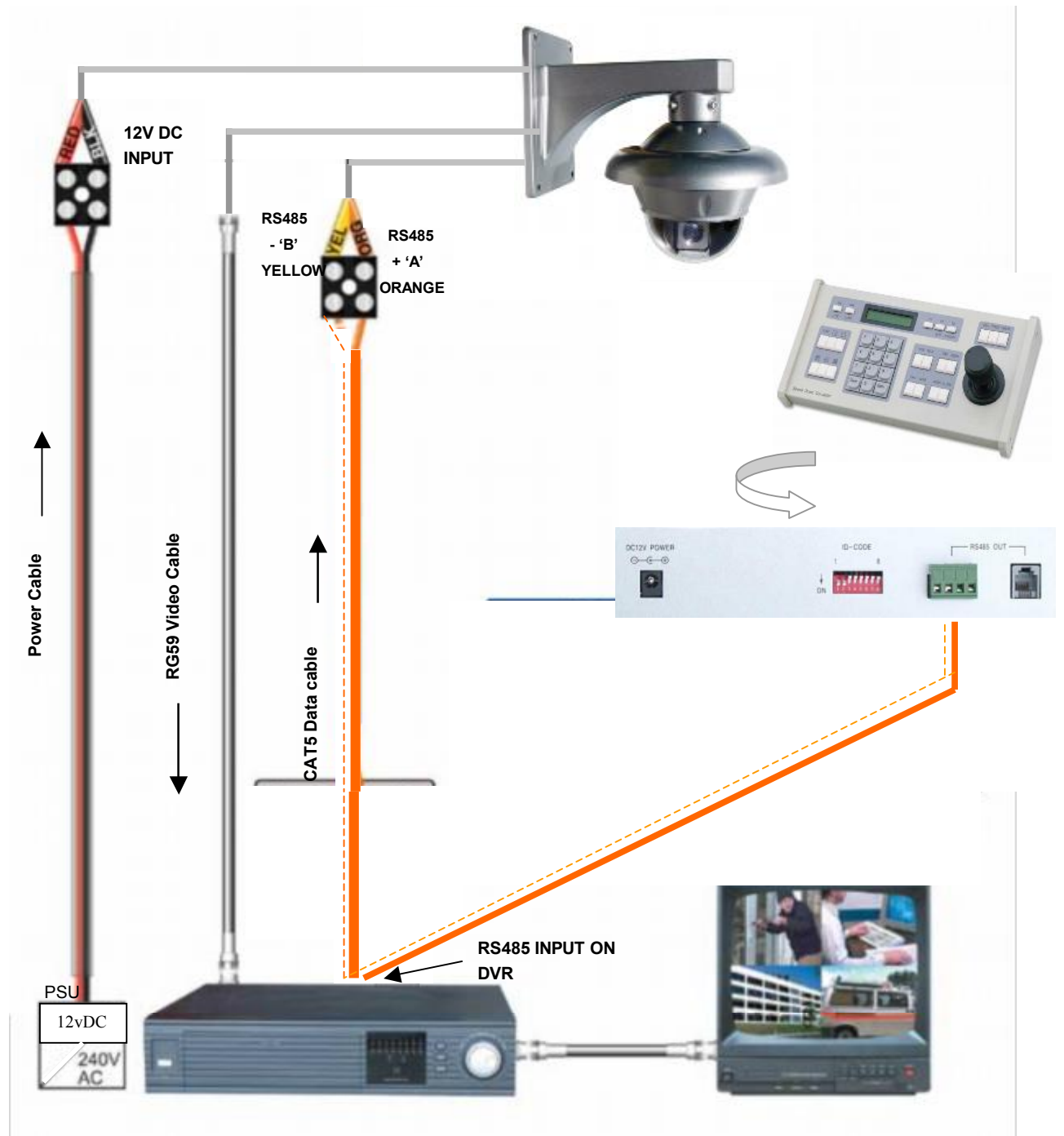

If you're using more than one dome on a site

Each dome has a unique “address” so that if you are using more than one on a site the keyboard “talks” to the right dome when you want it to PTZ. If you only have the one dome on the site then the default “address” of “1” is okay and you have no reason to change the dome from this.

With multiple dome sites you need to set up each dome address separately.

Special Note:

The only physical switch on this PTZ is for setting the termination resistor. There are no dipswitches for setting the address, protocol or baud rate. These are only configurable in the menu.

TIP - The connection of a 120Ω termination resistor: The termination resistor is ready fitted on the domes pcb, all you have to do to set it is to move the jumper from Pins 2 &3 to pins 1 & 2.

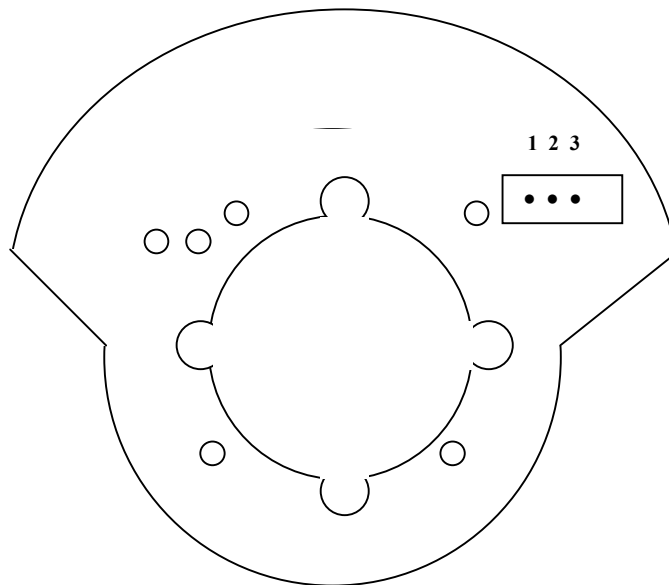

The termination resistor is set to on, in the last PTZ in the daisy chain. In a star RS485 arrangement it is set to on in the longest run for up to three PTZs and in the two longest runs, for more than three PTZs.

Setting up a unique ADDRESS in the dome

This dome does not have any dipswitches for setting the camera address. Changes can only be made via the PTZ menu.

SPECIAL NOTE:

As there are no dipswitches in this PTZ camera to set addresses, if you are installing more than one of these units, you will need to setup the address in each additional unit. As the PTZ cameras are set with address 001 which is not a unique number, to change the address it is necessary to enter the unique camera serial number first.

Entering the address in the menu

To enter the main menu CALL preset 64 or CALL preset 95 or CALL preset 1 twice within 4 seconds using the keypad or DVR with PTZ control.

Enter the **ADVANCE SETTING** menu and select **ID CHANGE**. Check the **CAMERA S/N:** and enter this in **INPUT S/N:** then enter the **NEW ID:** and enter the new ID from 001 – 255. Note that the **OLD ID:** will be set to 001 as set by the manufacturer.

Setup of the Protocol and the Default Baud Rate

The protocol and baud rate can only be changed by menu access. There are no dipswitches in this PTZ allowing protocol or baud rate changes. The default settings are for PELCO-D and BAUD RATE 2400bps.

Enter the main menu and select **SYSTEM SETTING** menu. Now select the **COMM SETUP** menu to change the **PROTOCOL:** to that required.

The following protocols can be selected:

B01	SANTACHI	PELCO-PD	PELCO-MK
PANASON	LC-NEW	HD600	LI-LIN
VICON	MOLYNX	KALATEL	VCL
SAMSUNG	ALEC	ULTRAK	

Enter the main menu and select **SYSTEM SETTING** menu. Now select the **COMM SETUP** menu to change the **BAUD RATE:** to that required.

The following baud rates can be selected:

2400	4800	9600	19200
-------------	-------------	-------------	--------------

Using the PTZ730 keypad with the excelPTZ series



PTZ730 keypad

NOTE 1: For more detailed instructions in setting up the keypad or using one of our other keypads, please refer to the instruction manual supplied with the product.

NOTE 2: The PTZ730 keypad requires you to press the function key first followed by the value e.g <CAM> **01** <Enter> whereas some keypads e.g PTZ700 require the value first, then the function e.g **01** <CAM> <Enter>

When you first take the keyboard out of the box you will need to set it up for the domes that you are using.

The dome you have purchased has the default settings of; PELCO-P/D 2400-BAUD rate Address 1

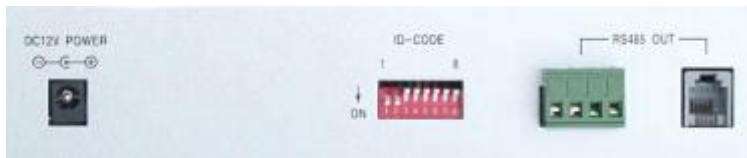

Rear of PTZ730 keypad

First read through the keypad instruction manual supplied. Set the protocol and baud rate in the keypad using the dipswitches on the rear of the unit. Note that all PTZ domes controlled by this keypad must have identical protocol and baud rate settings. The manual supplied with the keypad will show you what these settings should be.

Next connect the RS485 connections from the dome/s ensuring that the A and B lines are connected correctly.

Finally connect the power supply. Both the PTZ730 and PTZ700 keypads require a 12V DC PSU (500mA minimum).

It is recommended to use a POW800 or equivalent for this purpose. Now press the keypad ON button.

Select a PTZ camera by pressing CAM button followed by camera address and Enter*. The LCD display will indicate the camera channel selected. CAM 01 indicates that the keyboard is ready to talk to camera with address 1, if you have another dome set at camera address 2, press CAM button followed by 02 and Enter. This would change the display screen to CAM 02.

If you have multiple domes you will need to change the address of each dome so they are different but PLEASE LEAVE THE DOMES ON PELCO-P/D 2400 BAUD RATE.

* see NOTE 2 above.

PRESETS and other functions.

The dome has up to 128 presets that once programmed with stay in the domes non-volatile memory so they will be retained even after a power cut.

What is a preset? A preset is a particular area or object that the dome was looking at and has been stored into its memory so when the preset is “called-up” the dome will select the area again without the operator using the joystick to do this. Even the zoom at the time is stored into the preset. This means that you could for example store a PRESET of a car-park entrance. When the operator calls up this preset the camera automatically zooms in on this area. By storing more than one preset you can add even more functionality to the dome. By having two presets, you can then get the dome to “SCAN” between the two locations. You can even vary the speed of this scan.

Having 3 or more presets you can get the dome to go on a TOUR (PATROL) of the presets. When you run the patrol the dome goes to one preset, then waits a short period then on to the next preset and so on. The dome continues to cycle around this patrol until you cancel it. The length of time the camera stays at one location and the speed of travel between each preset point can be set in the menu.

PRESETS -How to set up a preset

Aim the dome where you want it to look, zoom in or out to get the correct scene and let the camera auto focus. Now press the following keys on the keypad : <PRESET> + **xx** + <Enter> (where **xx** is the preset number you wish to store). For example <PRESET> **01** <Enter> would store PRESET 01 and the camera would always go to this location when 01 is <CALLED>.

To test if the preset is stored correctly use the joystick to move the camera to point in a new location. Now press <CALL> **01** <Enter> (where **xx** is the preset you wish the camera to go to). In this example if you press <CALL> **01** <Enter> the dome should go straight to the PRESET 01 location.

TIP -You may wish to write down a list of presets that you have stored next to the keypad for the operator.

CALLING a preset

This may be as follows;

PRESET 01 = MAIN GATE (a long zoom shot)

PRESET 02 = ENTRANCE DOOR

PRESET 03 = FIRE ESCAPE

PRESET 04 = EMERGENCY EXIT

PRESET 05 = CAR PARK (zoomed-out wide angle)

PRESET 06 = CAR PARK (zoomed-in narrow angle)

When the operator wishes to quickly zoom in on the MAIN GATE all he has to do is press <CALL> **01**<Enter>. To go to the EMERGENCY EXIT he would press <CALL> **04** <Enter> and so on.

To call up any previously stored preset camera location, simply press <CALL> **xx** <Enter>, where **xx** is the preset number.

Patrols (Tours) – How to set them up and use them

A patrol (tour) is simply a collection of at least three preset camera locations that are run in sequence with the dome stopping at each location for a brief period of time and then moving on to the next preset.

For example, you could use a patrol so that an outside dome camera points at a gate, then at a side doorway, then zooms out to get an overall shot of a car park and finally zooming in on a delivery bay, before repeating the whole cycle again. Patrols can be useful for both outside and internal PTZ's. For a shop they could be used to cover key areas like clothes rails, tills and changing rooms in a sequence.

To set up a patrol you need to set up the individual stop points where the camera will pause. These are called *presets*.

An example four preset mini-tour

Setting the presets using the keypad

STEP 1- Using the keypad joystick, move to where you wish to start the tour and then press **<PRESET> 01 <Enter>**

STEP 2- Now move to the next location and press **<PRESET> 02 <Enter>**

STEP 3- Now move to the third location and press **<PRESET> 03 <Enter>**

STEP 4- Finally move to where you wish to end the tour and press **<PRESET> 04 <Enter>**

Deleting a preset

You may wish to delete a preset.

To do this press **<PRESET> xx <Enter>** holding the preset button down for 3 seconds at the end. (xx = preset number).

For example to delete preset 1, press **<PRESET> 01 <Enter>** (holding the preset button for 3 seconds)

Obviously if you wish to overwrite a preset with a new location, simply aim the camera at the new location and store the preset as normal, this will simply overwrite the old preset.

Setting the Patrol (Tour)

To setup the patrol/tour you need to enter the Advanced Menu System by selecting **<CALL> 95 <Enter>** on the keypad or **<CALL> 64 <Enter>**. (Call varies according module type)

You will see the **Main Menu** displayed on the screen.

Enter the password to enter the menu. The Default is **11111**. See Advance Setup menu to change.

Using the joystick up/down direction movement, select the **MOTION SETUP** menu. Use the joystick pan right movement to enter this menu.

Now use the Joystick up/down direction movement to select **PATROLS**. To the right of this, is the patrol sequence number. By moving the Joystick to the right this number can be increased from 01 to 06 (up to six patrols/tours can be programmed) or decreased using the left direction movement. Start with sequence **01**.

Now select **EDIT PATROL** and press the **OPEN** button to select edit mode. A table will be displayed showing 16 patrol item numbers. Note that the screen is divided into two halves with two patrol positions per line. Only the odd patrol item numbers are identified down the left hand side of the display. In the bottom left hand corner the patrol sequence number is displayed. This can be 01 ~ 06.

In the example we are setting four presets in the first patrol sequence.

To edit a patrol sequence

NO Patrol Item No.
POS No. of Preset Position
TM Dwell time at this position
Time 0 ~ 99 seconds
SEQ:nn The Patrol number. (01 ~ 06)

NO	POS	TM	NO	POS	TM
01	001	01	02	002	01
03	003	01	04	004	01
05	---	--	06	---	--
07	---	--	08	---	--
09	---	--	10	---	--
11	---	--	12	---	--
13	---	--	14	---	--
15	---	--	16	---	--
PATROL:01			CLOSE:EXIT		

Special Note: The patrol item number (**NO**) is an ascending number list of the preset items within this sequence. It may not necessarily reflect the actual preset number. You could for instance have preset item (**NO**) 01 with preset position 004 as the first preset required.

Enter the preset position number (**POS**) and the dwell time (**TM**) for each preset by using the Joystick up/down movement. Move the Joystick to the right to move to the next field.

After including all the presets required in this patrol/tour, press the Keypad **CLOSE** button to exit. If you add extra presets later and wish to incorporate into a patrol/tour already created, you must add the additional preset positions in the necessary EDIT PATROL table sequence.

Now exit the menu by moving the Joystick down, selecting **EXIT** and then moving the Joystick to the right to return to the Main Menu. Again use the Joystick to select **EXIT** and exit the Advanced Menu System by selecting the right pan movement.

Calling the Patrol (Tour)

There are two methods of initiating the patrol or tour. If you enter **<CALL> 91 <Enter>** via the keypad you can initiate patrol/tour sequence 1 only.

You may also initiate a patrol or tour through the Advanced Menu System.

Enter **<CALL> 95 <Enter>** or **<CALL> 64 <Enter>** on the keypad. Enter the password to enter the menu.

The Default password is **11111**. See Advance Setup menu to change.

You will then see the **Main Menu** displayed on the screen.

Using the joystick up/down direction movement, select the **MOTION SETUP** menu. Use the joystick pan right movement to enter this menu.

Now use the Joystick up/down direction movement to select **PATROLS**. To the right of this, is the patrol sequence number (**xx**). By moving the Joystick to the right this number can be increased from 1 ~ 6 (up to six patrols/tours can be programmed) or decreased using the left direction movement. Now select **RUN PATROL** button to initiate the patrol/tour sequence number.

Special Note: If you notice that some expected presets are not being incorporated in a patrol/tour, check that the PATROL table has been setup correctly and shows all presets for the required sequence. A full explanation of the values to be set can be found in the previous section *Setting the Patrol (Tour)*.

TIP - To stop the PATROL just move the joystick slightly.

AUTO SCAN- How to set it up

Auto-scan scans between two points. These are not presets as per the patrol(tour) facility but auto scan selection points. You may program up to 3 auto scans.

STEP 1 – Select the required camera by pressing the <CAM> button and then entering <camera address> on the keypad.

To setup the Auto Scan you need to enter the Menu System by selecting <CALL> 95 <Enter> or <CALL> 64 <Enter> on the keypad.

Enter the password to enter the menu.

The Default password is **11111**. See Advance Setup menu to change.

You will see the **Main Menu** displayed on the screen.

Using the joystick up/down direction movement, select the **MOTION SETUP** menu. Use the joystick pan right movement to enter this menu.

In the **AUTO SCAN** menu select the scan number (maximum 3), then the speed. Now position the camera where you wish to start scanning from. Using the joystick select **SET START LIMIT**. Then press the **CLOSE** button to save the start position.

Now aim the camera where you wish to end the scanning point. Now select the **SET END LIMIT** followed by **CLOSE** button to save.

Calling the Auto Scan

First you must set the start and end positions of the auto scan as above. This runs the auto scan function between these two points. There are two methods of initiating the auto scan. If you enter

< CALL> 97 <Enter> via the keypad you can initiate the auto scan. Note that the CALL 97 will run at the speed set in the **AUTO SCAN** table.

You may also initiate the auto scan through the Advanced Menu System. Enter the Main Menu by selecting <CALL> 95 <Enter> or <CALL> 64 <Enter> on the keypad.

Enter the password to enter the menu.

The Default password is **11111**. See Advance Setup menu to change.

You will see the **Main Menu** displayed on the screen.

Using the joystick up/down direction movement, select the **MOTION SETUP** menu. Use the joystick pan right movement to enter this menu.

In the **AUTO SCAN** menu select **RUN SCAN**. If the start position is the same as the end position it will do a 360° scan. Now press the **CLOSE** button to save and initiate the Auto Scan.

TIP - To stop the scan just move the joystick slightly.

RECORD PATTERN- What is a record pattern

This dome has an option to store a record pattern. A record pattern consists of a continuous sequence of standard pan and tilt movements or lens commands recorded within a 200 second interval. A record pattern does not use presets. You can limit movement at a required position and pan and tilt within the 200 second time restriction. Once the recording is complete, i.e you have closed the recording or the record time has expired, you may use an option in the Motion Setup Menu to replay the recorded pattern. Once this recorded pattern is initiated, the dome will run the record pattern continuously until a keypad movement is detected or an alarm is activated.

RECORD PATTERN- What is the difference between a pattern & a patrol (tour)

A patrol (tour) uses presets and when initiated, the dome will move to a maximum of 16 preset positions using the dwell times as set in the Patrol Table. The speed of dome movement between any two presets is a constant speed and not a variable speed. A patrol (tour) can run for an extensive length of time with a dwell time of a maximum of 99 seconds at each of sixteen preset positions. In addition up to six different patrols (tours) can be stored each with different preset parameters whereas only three record patterns can be recorded. When a preset is stored the dome stores not only the preset position but also zoom and camera attributes. A record pattern does not record zoom attributes.

A record pattern does not use presets. It however allows the user to record a continuous sequence of standard pan and tilt movements or lens commands but does not allow presets, flip, digital zoom, proportional pan or turbo speed. The record pattern sequence can be recorded using the keypad pan and tilt joystick but will only record up to a 200 second interval. A record pattern allows the user a continuous view rather than selected preset positions and is similar to an auto scan except that an auto scan only allows a selected movement speed whereas the record pattern reflects the user movements made during the recording of the record pattern.

RECORD PATTERN- How to set it up

Record Pattern allows a pattern to be recorded which consists of any standard pan and tilt or lens command within a 200 second interval. A pattern is automatically closed when the 200 second interval is exceeded or by pressing the CLOSE button. Note that the following are not allowed in a pattern: presets, flip, digital zoom, proportional pan and turbo.

STEP 1 – Select the required camera by pressing the **CAM** button and entering <camera address> followed by <Enter> on the keypad.

Position the camera where you wish to start the record pattern sequence. Enter the Main Menu System by selecting <CALL> **95** <Enter> or <CALL> **64** <Enter> on the keypad.

Enter the password to enter the menu.

The Default password is **11111**. See Advance Setup menu to change.

You will see the **Main Menu** displayed on the screen.

Using the joystick up/down direction movement, select the **MOTION SETUP** menu. Use the joystick pan right movement to enter this menu.

STEP 1 - In the **PATTERNS** menu select **PATTERN NUMBER** and enter number from 1 ~3 .

Now select **RECORD PATTERN**.

STEP 2 – Now move the camera using the keypad joystick to record up to a 200 second sequence and follow this by pressing the **CLOSE** button to save. The record pattern will be stored for future replay.

Running the Record Pattern

First you must have recorded a record pattern as detailed above. This runs a record pattern of up to 200 seconds duration. You can run the Record Pattern through the Main Menu. Enter the Main Menu by selecting <CALL> **95** <Enter> or <CALL> **64** <Enter> on the keypad.

Enter the password to enter the menu.

The Default password is **11111**. See Advance Setup menu to change.

You will see the **Main Menu** displayed on the screen.

Using the joystick up/down direction movement, select the **MOTION SETUP** menu. Use the joystick pan right movement to enter this menu.

In the **PATTERNS** menu select **RUN PATTERN**. Now press the **CLOSE** button to save and initiate the Pattern sequence. This will run continuously.

TIP - To stop the record pattern just move the joystick slightly.

USING THE DOME'S ADVANCED FUNCTIONS-

On Screen Graphics (OSD) –

The PTZ605 series boasts six patrol (tour) options, an auto scan option and a record pattern option. All these can be configured using the OSD.

To bring up the camera menu press **<CALL> 95 <Enter>** or **<CALL> 64 <Enter>** (varies with module type).

Note that entering Preset 01 twice within 4 seconds will also open the menu.

Enter the password to enter the menu.

The Default password is **11111**. See Advance Setup menu to change.

The OSD is then displayed on the screen. You can navigate between the various options using the Joystick control – up to increase and down to decrease – right pan to enter and left pan to exit. You can also use the OPEN button to enter and the CLOSE button to save and exit.

THE MENU SYSTEM

Using the Menu System.

This menu system allows the user to alter the dome menu instruction options and settings using a control keypad. This first page shows the initial main menu page and only describes the general functions. The following pages show the main menu option selected on the left hand side of the page and a breakdown of that menu page on the right hand side of the page.

MAIN MENU

To enter the main menu system press **CALL 95 <Enter>**
or **<CALL> 64 <Enter>**
on the Keypad. Enter the password to enter the menu.
The Default password is **111111**. See Advance Setup to change.

Use the Joystick control pan up or pan down to increase or decrease a value and pan left or pan right to enter a selection.

The OPEN button can also be used to enter a selection and the CLOSE button to exit.

To leave the main menu press EXIT in Main Menu.

- | |
|---|
| <p style="text-align: center;">MAIN MENU</p> <ol style="list-style-type: none">1. SYSTEM SETUP2. DISPLAY SETUP3. CAMERA SETUP4. MOTION SETUP5. PRIVACY MASK6. ADVANCE SETUP7. SYSTEM RESET8. EXIT |
|---|

DESCRIPTION OF MENU OPTIONS

SYSTEM SETUP: Displays System Information – switches auto flip on or off – sets proportional pan speed - selects alarm function on or off – sets action after alarm.

DISPLAY SETUP: Switches camera name display - angle display – preset label display – dome label display - positions of each display.

CAMERA SETUP: D-Zoom on or off – Camera info display – Focus mode - Auto/day/night – BLC on or off – Line Sync – Slow shutter – Automatic exposure – White balance mode – WDR – Exposure compensation.

MOTION SETUP: Set presets – Auto Scan – Patrols – Patterns – Clear options.

PRIVACY MASK: Set Privacy Mask areas and Mask colour.

ADVANCE SETUP: Sets the Home option – Password – Camera ID setup – Fan control temperature – Language Set North position.

SYSTEM RESET: To select camera default settings.

EXIT: To exit menu.

To access System Setup press the OPEN button on keypad or move the Joystick to the right. The menu

MAIN MENU

- 1. SYSTEM SETUP**
- 2. DISPLAY SETUP**
- 3. CAMERA SETUP**
- 4. MOTION SETUP**
- 5. PRIVACY MASK**
- 6. ADVANCE SETUP**
- 7. SYSTEM RESET**
- 8. EXIT**

below will be displayed.



SYSTEM SETUP

- 1. SYSTEM INFORMATION**
- 2. AUTO FLIP OFF**
- 3. PROP PAN SPD OFF**
- 4. <COMM SETUP><see below>**
- 5. RETURN**

1. SYSTEM INFORMATION

This displays system information.

2. AUTO FLIP ON / OFF

When this is set to ON the PTZ will automatically flip at 180°.

3. PROP PAN SPD ON / OFF

Proportional Pan Speed function allows speed control dependent on current speed ratio.

4. <COMM SETUP>

Allows the setting of the protocol or baud rate.

SYSTEM INFORMATION

CAMERA S/N: nnnnnnn
CAMERA ID : 001
PROTOCOL : PELCO-PD
BAUD RATE : 2400BPS
MODEL : A100P
VERSION : V1.30MG

COMM SETUP

- 1. PROTOCOL: PELCO-PD**
- 2. BAUD RATE: 2400**
- 3. SAVE&RETURN**
- 4. CANCEL&RETURN**

PROTOCOL:

Select the required protocol from the following list:

B01	SANTACHI	PELCO-PD	PELCO-MK
PANASON	LC-NEW	HD600	LI-LIN
VICON	MOLYNX	KALATEL	VCL
SAMSUNG	ALEC	ULTRAK	

BAUD RATE:

Select the required baud rate.

2400 4800 9600 19200

SAVE&RETURN

Save the changes and return to main menu.

CANCEL&RETURN

Cancels changes and returns to main menu.

Move the Joystick down to select Display Setup and press the OPEN button or move the Joystick to the right. The menu below will be displayed.



- MAIN MENU**
1. SYSTEM SETUP
 - 2. DISPLAY SETUP**
 3. CAMERA SETUP
 4. MOTION SETUP
 5. PRIVACY MASK
 6. ADVANCE SETUP
 7. SYSTEM RESET
 8. EXIT

- DISPLAY SETUP**
1. <CAMERA ID> <see 1 below>
 2. <ANGLE DISPLAY><see 2 below>
 3. <PRESET LABEL> <see 3 below>
 4. <DOME LABEL> <see 4 below>
 5. RETURN

- CAMERA ID (1)**
1. DISPLAY ON
 2. POSITION TOP-R
 3. RETURN

DISPLAY

When set to ON the camera ID will be displayed.

POSITION TOP-L, TOP-R, BOTT-R, BOTT-L

Positions the camera ID on the screen. Choose from TOP-L (top left corner), TOP-R (top right corner), BOTT-R (bottom right) & BOTT-L (bottom left)

- ANGLE DISPLAY (2)**
- DISPLAY ON
 - POSITION TOP-R
 - RETURN

DISPLAY

When set to ON the angle will be displayed. ONEPUSH displays for 4 seconds only.

POSITION TOP-L, TOP-R, BOTT-R, BOTT-L

Positions the angle display on the screen. Choose from TOP-L (top left corner), TOP-R (top right corner), BOTT-R (bottom right) & BOTT-L (bottom left).

- PRESET LABEL (3)**
DOME LABEL (4)
- DISPLAY ON
 - POSITION TOP-R
 - RETURN

DISPLAY

When set to ON the PRESET No. or DOME No. will be displayed.

POSITION TOP-L, TOP-R, BOTT-R, BOTT-L

Positions the angle display on the screen. Choose from TOP-L (top left corner), TOP-R (top right corner), BOTT-R (bottom right) & BOTT-L (bottom left).

Move the Joystick down to select Camera Setup and press the OPEN button or move the Joystick to the right. The menu below will be displayed.



MAIN MENU	
1.	SYSTEM SETUP
2.	DISPLAY SETUP
3.	CAMERA SETUP
4.	MOTION SETUP
5.	PRIVACY MASK
6.	ADVANCE SETUP
7.	SYSTEM RESET
8.	EXIT

CAMERA SETUP	
1. D-ZOOM	OFF
2. DISPLAY	N/A
3. FOCUS MODE	AF AUTO
4. ICR	AUTO
5. BLC	OFF
6. RESERVED	N/A
7. SLOWSHUTTER	N/A
8. <WB/AE SETUP>	
RETURN	

NOTE: The following camera setup options depend on the camera type installed.

1. D-ZOOM ON / OFF

The digital zoom can be set by switching this to ON.

2. DISPLAY ON / OFF / N/A

The camera information is displayed if this option set to ON. Note that if camera setting is displayed as N/A it means the camera does not support this feature.

3. FOCUS MODE MANUAL / A-AUTO / F-AUTO / AF-AUTO

- MANUAL NON – manual iris and focus
- A-AUTO - auto iris
- F-AUTO - auto focus
- AF-AUTO - auto iris and focus

4. ICR AUTO / DAY / NIGHT

This option selects AUTO for colour in day and b/w at night
 DAY stays in colour mode
 NIGHT stays in b/w mode

5. BLC ON / OFF

This switches on backlight compensation

8. <WB/AE SETUP>

White Balance Mode/Automatic Exposure.

WB/AE SETUP	
1. AE MODE	AUTO
SHUTTER	N/A
2. WB MODE	ATW
R GAIN	N/A
B GAIN	N/A
3. WDR MODE	N/A
4. <EXPCOMP SETUP>	N/A
5. RETURN	

1. AE MODE Automatic Exposure **AUTO / MANU / SHUTTER**
Normally set to AUTO.

SHUTTER
Only available if AE MODE is set to SHUTTER
Select from **1/50, 1/100, 1/250, 1/500, 1/700, 1/1000, 1/1600, 1/2500, 1/5000.**

2. WB MODE **ATW / MANUAL**
This option is set to ATW. (Auto Tracking White Balance – suitable for changing colour)

5. RETURN
Return to WB/AE SETUP menu.

Move the Joystick down to select Motion Setup and press the OPEN button or move the Joystick to the right. The menu below will be displayed.



<p>MAIN MENU</p> <ol style="list-style-type: none"> 1. SYSTEM SETUP 2. DISPLAY SETUP 3. CAMERA SETUP 4. MOTION SETUP 5. PRIVACY MASK 6. ADVANCE SETUP 7. SYSTEM RESET 8. EXIT
--

<p>MOTION SETUP</p> <ol style="list-style-type: none"> 1. <PRESETS> 2. <AUTO SCAN> 3. <PATROLS> 4. <PATTERN> 5. <CLEAR> 6. EDIT DOME LABEL 7. RETURN

<PRESETS>

Enter the preset menu.

1. PRESET NO 01 ~ 128

2. EDIT LABEL

This option allows editing of the preset label. The edit label refers to the preset number selected. The PANLEFT/RIGHT can move the cursor and TILT UP/DOWN can modify the number. Press the CLOSE to save and exit. Up to 10 characters can be specified including 0 ~ 9, A ~ Z and special characters including < = > ? , @ \ + - . /]

The first character must be either 0 ~ 9 or A ~ Z. When testing the preset display it will only show NO.XXX and not the label name.

<p>PRESETS</p> <ol style="list-style-type: none"> 1. PRESET NO. 01 2. EDIT LABEL 3. CLR LABEL 4. RETURN
--

<p>PRESET NO: 01 LABEL: NO LABEL</p> <p style="margin-top: 20px;">CLOSE:EXIT</p>

<AUTO SCAN>

This option allows the setting and the running of the Auto Scan.

1. SCAN NO.

Sets the scanning number. Maximum is 03.

2. SPEED

Set the speed 1 ~ 7.

3. SET START LIMIT

To set the start position enter this menu item and then move the joystick to position the camera at the starting position and then press CLOSE to save the start position. (IRIS – can be used on the Alien DVR)

4. SET END LIMIT

To set the end position select this menu item and then move the joystick to position the camera at the end position and then press CLOSE to save the end position. (IRIS – can be used on the Alien DVR)

<p>AUTO SCAN</p> <ol style="list-style-type: none"> 1. SCAN NO. 001 2. SPEED 001 3. SET START LIMIT 4. SET END LIMIT 5. RUN SCAN 6. CLEAR SCAN 7. RETURN

5. RUN SCAN

To run a scan first set the start and end position. Note that if the start and end position are the same the dome will scan 360 degrees. Press CLOSE to exit.

6. CLEAR SCAN

If you wish to clear the auto scan select this item and then press CLOSE to exit.

<PATROLS>

Enter this menu to set a patrol.
(Also known as tours or sequences)

1. PATROL NO 1 ~ 6

Set the patrol (tour) number

2. EDIT PATROL

This option allows editing .

NO Preset point number
POS Preset number
TM Time stopping in seconds

SPECIAL NOTE

Two patrol presets are displayed per line.
--- means no preset set

PATROL NO 1 ~ 6

Relates to patrol number. Maximum 6.
Press Pan LEFT/RIGHT to move cursor
and Tilt UP/DOWN to change data. Then
press CLOSE to save and exit.

PATROLS		
1. PATROL NO.	001	
2. EDIT PATROL		
3. RUN PATROL		
4. CLEAR PATROL		
5. RETURN		

NO	POS	TM	NO	POS	TM
01	001	01	02	002	01
03	003	01	04	004	01
05	005	01	06	003	01
07	---	--	08	---	--
09	---	--	10	---	--
11	---	--	12	---	--
13	---	--	14	---	--
15	---	--	16	---	--
PATROL: 01			CLOSE : EXIT		

3. RUN PATROL

Click on this menu item and then press CLOSE to start patrol.

4. CLEAR PATROL

Click to clear a patrol.

5. RETURN

Returns to MOTION SETUP menu.

<PATTERNS>

1. PATTERN NO.

Allows recording of a pattern for up to 200 seconds.
Up to 3 patterns can be recorded.

2. RECORD PATTERN

Click on this menu item to start pattern recording
and when complete press CLOSE to save.

3. RUN PATTERN

Start the run of a pattern and exit from the
menu. Any movement of the joystick will stop this function.

4. CLEAR PATTERN

Click on this to clear the pattern.

5. RETURN

Click on this to return to the MOTION SETUP menu.

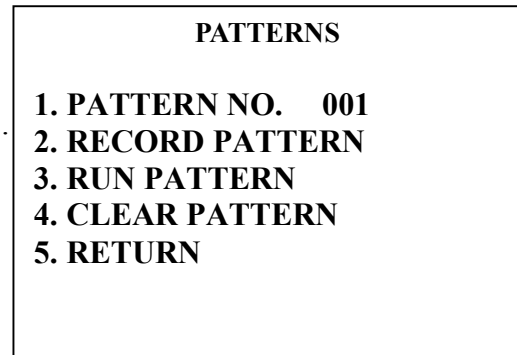

<CLEAR> This option clears all options.

1. CLEAR ALL PRELABELS Clears all presets.

2. CLEAR ALL SCANS Clears all scans.

3. CLEAR ALL PATROLS Clears all patrols.

4. CLEAR ALL PATTERNS Clears all patterns.

5. RETURN Returns to MOTION SETUP menu.

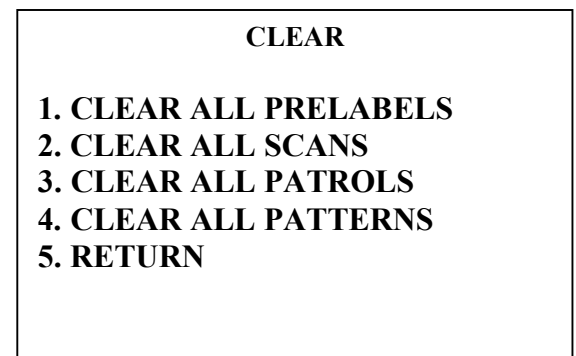

EDIT DOME LABEL This options allows editing of Dome Label. Refer to EDIT LABEL in PRESETS menu for details. The label is made up of 10 characters.

RETURN Return to main menu.

Move the Joystick down to select Motion Setup and press the OPEN button or move the Joystick to the right. The menu below will be displayed.



MAIN MENU	
1.	SYSTEM SETUP
2.	DISPLAY SETUP
3.	CAMERA SETUP
4.	MOTION SETUP
5.	PRIVACY MASK
6.	ADVANCE SETUP
7.	SYSTEM RESET
8.	EXIT

PRIVACY MASK	
1. PRIVACY MASK	01
2. MASK SHADE	WHITE
3. DISPLAY	ON
4. EDIT MASK	
5. RETURN	

1. PRIVACY MASK 01 ~ 04

Up to 4 privacy mask areas to be set according to camera options available.
Note that the mask area moves with the PTZ location.

2. MASK SHADE

This allows the colour of the mask area to be set.

3. DISPLAY ON / OFF

This option can switch on or off the privacy mask function

4. EDIT MASK

This option allows editing of the mask area.

Allows the size of the mask area to be set.

(Use the Zoom and Focus controls on the Alien DVR)

5. RETURN

Click to return to main menu.

Move the Joystick down to select Motion Setup and press the OPEN button or move the Joystick to the right. The menu below will be displayed.



- MAIN MENU**
1. SYSTEM SETUP
 2. DISPLAY SETUP
 3. CAMERA SETUP
 4. MOTION SETUP
 5. PRIVACY MASK
 - 6. ADVANCE SETUP**
 7. SYSTEM RESET
 8. EXIT

- ADVANCE SETUP**
- 1. <HOME SETUP>**
 2. <PASSWORD>
 3. <CAM ID SETUP>
 4. <FAN CONTROL>
 5. LANGUAGE: ENGLISH
 6. SET NORTH POSITION
 7. RETURN

<HOME SETUP>

This option must not be confused with the Alarm function that can be set with different timing settings.

1. AUTO HOME ON / OFF

If the AUTO HOME is set to ON the dome camera will revert to the home position without any action in the PARK TIME.

- HOME SETUP**
- 1. AUTO HOME OFF**
 - 2. HOME ACTION PATROL1**
 - 3. PARK TIME 04 MIN**
 - 4. PWR RESUME OFF**
 - 5. RETURN**

2. HOME ACTION PATROL n / SCAN n / PATTERN n / 01 ~ 50 (preset no.) / RESUME

This is used to set the auto home action. For example this option will restart a patrol, auto scan, pattern or move to a specific preset point if the current action is interrupted e.g manual movement of the joystick, reboot etc. Resume returns to the position prior to manual intervention.

3. PARK TIME nn

This sets the wait time duration for the dome. The time can be set from 01 ~ 99 minutes.

4. PWR RESUME ON / OFF

If this is set to ON the dome camera will resume the operation that it was handling prior to loss of power.

5. RETURN

This returns to the Advance Setup menu.

- MAIN MENU**
1. SYSTEM SETUP
 2. DISPLAY SETUP
 3. CAMERA SETUP
 4. MOTION SETUP
 5. PRIVACY MASK
 - 6. ADVANCE SETUP**
 7. SYSTEM RESET
 8. EXIT

- ADVANCE SETUP**
1. <HOME SETUP>
 - 2. <PASSWORD>**
 3. <CAM ID SETUP>
 4. <FAN CONTROL>
 5. LANGUAGE: ENGLISH
 6. SET NORTH POSITION
 7. RETURN

PASSWORD

This option allows password protection.

1. PASSWORD ON / OFF

If this is set to ON password protection is Initiated. The default password is **11111**

2. MODIFY KEY nnnnnn

This is for entering a new password. 6 character numeric field.

3. CONFIRM KEY nnnnnn

This is to confirm the new password.

4. RETURN

This returns to the ADVANCE SETUP menu.

- PASSWORD**
- 1. PASSWORD ON**
 - 2. MODIFY KEY * * * * ***
 - 3. CONFIRM KEY * * * * ***
 - 4. RETURN**

- MAIN MENU**
1. SYSTEM SETUP
 2. DISPLAY SETUP
 3. CAMERA SETUP
 4. MOTION SETUP
 5. PRIVACY MASK
 - 6. ADVANCE SETUP**
 7. SYSTEM RESET
 8. EXIT

- ADVANCE SETUP**
1. <HOME SETUP>
 2. <PASSWORD>
 - 3. <CAM ID SETUP>**
 4. <FAN CONTROL>
 5. LANGUAGE: ENGLISH
 6. SET NORTH POSITION
 7. RETURN

CAM ID SETUP

This enters the software ID settings menu

1. CAMERA S/N:

Displays the dome series number

2. INPUT S/N:

Inputs the dome series number.

3. OLD ID:

Displays the old dome address.

4. NEW ID: *

Displays the new dome address.

Input the series number before inputting the new ID.

5. SAVE & RETURN

To save and return to the ADVANCE SETUP menu.

6. CANCEL & RETURN

To cancel and return to the ADVANCE SETUP menu.

*NEW ID CHANGE

This is the dome ID address setting. The Camera serial number is a 7 bit non-modifiable Serial number. Set the Input Serial number to the same as the Camera serial number using the joystick or DVR. In the Alien DVR PTZ menu you can change the number using the up and down direction keys. The OLD ID displays the old dome address and is non-modifiable. The NEW ID is the new dome address.

Note that if the INPUT S/N is not correctly entered in advance of this entry, an error "S/N ERROR!" will be displayed at bottom of display screen. Also the dome ID address range allows 1 ~ 999 to be addressed but different protocols may limit the software addressable range. The PELCO protocol allows the 1 ~ 255 address range to be allocated. Save & Return saves the new setting and returns to the previous menu or Cancel & Return does not save the setting and returns to the previous menu.

CAM ID SETUP	
1. CAMERA S/N:	9999999
2. INPUT S/N:	0000000
3. OLD ID:	001
4. NEW ID	002
5. SAVE & RETURN	
6. CANCEL & RETURN	

MAIN MENU
1. SYSTEM SETUP
2. DISPLAY SETUP
3. CAMERA SETUP
4. MOTION SETUP
5. PRIVACY MASK
6. ADVANCE SETUP
7. SYSTEM RESET
8. EXIT

ADVANCE SETUP
1. <HOME SETUP>
2. <PASSWORD>
3. <CAM ID SETUP>
4. <FAN CONTROL>
5. LANGUAGE: ENGLISH
6. SET NORTH POSITION
7. RETURN

FAN CONTROL)

To set the fan control menu settings.

1. FAN ON / OFF / AUTO

The fan working conditions can be set.

Setting to ON will set fan running and OFF will switch fan off.

If set to AUTO the working temperature of the fan can be set in OPEN TEMP.

2. OPEN TEMP: nn (nn = 28 ~ 50)

Allows the working temperature of the fan to be set if FAN option is set to AUTO.

3. TEMP DISPLAY ON / OFF

If set to ON the temperature of dome will be displayed.

4. RETURN

Return to ADVANCE MENU setup.

5. LANGUAGE

Allows text to be displayed in various languages.

6. SET NORTH POSITION

Allows north position to be set.

RETURN

Exits main menu

FAN CONTROL

1. FAN ON
2. OPEN TEMP: 39
3. TEMP DISPLAY ON
4. RETURN

ADVANCE SETUP

1. <HOME SETUP>
2. <PASSWORD>
3. <CAM ID SETUP>
4. <FAN CONTROL>
5. LANGUAGE: ENGLISH
6. SET NORTH POSITION
7. RETURN

MAIN MENU

1. SYSTEM SETUP
2. DISPLAY SETUP
3. CAMERA SETUP
4. MOTION SETUP
5. PRIVACY MASK
6. ADVANCE SETUP
7. SYSTEM RESET
8. EXIT

7. SYSTEM RESET

Selecting this option resets the PTZ menu.

The dome will undertake a self test after it undertakes the reset. The following functions are reset: Auto Flip on, PTZ SPD Rate on, ID Display on, Angle Display Off, Dome Label Display Off, D-Zoom Off, PT Interlock – AF Auto, BLC Off, Auto Home Off, Park Time 4 mins, Fan Auto, Temp Display Off.

8. EXIT

Exit the main menu.

Controlling one camera then another.

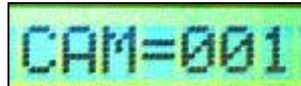

If you look at the image of the LCD display on the keypad you can see the CAM=001 indicates that the keyboard is ready to talk to camera with address 1. In the dome the address 1 is set as default in the factory. You need to alter the internal ID address to 002, 003 etc if you have multiple domes on the same site.

Refer to the previous instructions on how to set the internal ID number. If you have another dome set at camera address 2, press CAM followed by 2. This would change the screen to CAM=002. And so on.

Note that on this camera there are no dipswitches, so changes to the camera ID must be made via the software.

System Installation

Outdoor Wall Installation

Unpack the carton and carefully remove the dome camera and attachments.

Fit the flange on the outdoor sunshade with three M4 x 8 inner hexagon screws.

Fit the flat bottom plate to the sunshade with three M3 x 6 pan head screws.

Remove the dome and connect three fast fix screws into the flat plate of the dome and connect it to the sunshade by turning the dome clockwise to tighten it. Finally fit the camera bottom pedestal board to the camera connection board with an M3 screw.

Now drill holes in the wall for fitting the bracket, feed the connecting cables through the bracket arm and secure the bracket to the wall.

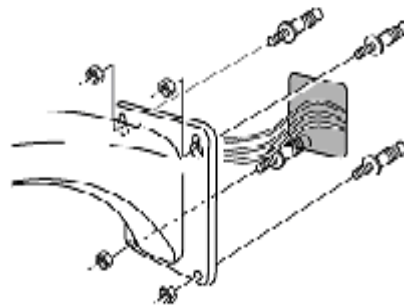

Connect the cables from the dome to these cables and pull the cables back through the bracket arm. Now secure dome to bracket using the four connection screws.

Indoor Ceiling Installation

Unpack the carton and carefully remove the dome camera and attachments.

Fit the bottom flat plate to the ceiling and connect three fast fix screws into the plate.

Now attach the dome by turning clockwise to tighten it. Finally lock unit with an M3 screw.

Indoor Wall Installation

Unpack the carton and carefully remove the dome camera and attachments.

Using the indoor wall angle bracket, attach this to the wall using four M6 screws.

Fit the three fast fix screws to the base of the dome and secure to the indoor angle bracket by turning clockwise and secure with an M3 screw.

Technical Specification

Power Supply	12v DC 2A regulated power supply
Synchronisation	Internal
Preset positions	128
No. of Tours / Patrols	6
Pattern record time	3 patterns for up to 120 seconds per pattern
Privacy zone masking	4 areas that move when PTZ moves
Zoom rotation interaction	The dome will automatically adjust manual control speed
Auto overturning	The camera rotates 180° when vertical position reached
Pan scanning	360° programmable
Pan speed	0° ~ 300° per second
Pan range	360° continuously
Tilt range	0° ~ 90°
Tilt speed	0° ~ 120° per second
Communication	RS485
Baud Rate	2400/4800/9600/19200
Fan / Heater	Auto (outdoor use only)
Relative humidity	10 ~ 75%
Working Temperature	Indoor: 0°C ~ +40°C Outdoor -35°C ~ +55°C

Appendix A: General Information

The Cleaning of Clear Dome Cover

To obtain constant clear images, the user should clean the dome cover periodically.

- Be very careful when cleaning. Hold the dome cover ring only to avoid touching the acrylic dome cover. The acid from fingerprints will corrode the coating and any scratches on the dome cover may cause distorted or poor images.
- Use a soft dry cloth or a similar to clean the inner and outer surfaces.
- For more stubborn contamination, use a neutral detergent. Any cleanser for high-grade furniture is applicable.

Troubleshooting

1. To avoid problems and to ensure the PTZ has been correctly setup it is always advisable to test the equipment in your workshop before you go on-site. If workshop setup is successful, any problems experienced on-site will be greatly minimised.
2. Always read these instructions before you connect the equipment to any power supply and check that you are using the correct rated power supply and voltage. Never connect non-regulated power supplies.

If you are having problems with no video, power the PTZ and plug the video cable direct into your monitor. If still no video then check if PTZ is running the initial self test. If not check power to the PTZ, cables and connections. Remember that every PTZ is tested before despatch to you so it will be very unlikely to be a faulty PTZ unit. Note that video loss can occur on a long cable run, or loss of signal strength resulting in no video, poor quality video or even video in black and white mode. Ensure the termination jumper is correctly set in the PTZ dome head. This is accurately detailed in this manual.

3. If video is okay but the telemetry is not working then check the software settings in the dome agree with the settings in the control unit i.e keypad or DVR. The software sets the protocol, baud rate and PTZ address. Ensure that the RS485 cable connecting the PTZ to the control unit is connected the right way around.



This symbol on the products and/or accompanying documents means that used electronic equipment must not be mixed with general household waste. For treatment, recovery and recycling please return this unit to your trade supplier or local designated collection point as defined by your local council.

All specifications are approximate. Kovert.com reserves the right to change any product specification or features without notice. Whilst every effort is made to ensure that these instructions are complete and accurate, kovert.com cannot be held responsible in any way for any losses, no matter how they arise, from errors or omissions in these instructions, or the performance or non-performance of the camera or other equipment that these instructions refer.