



# Instruction Manual

RoboPlate

xROBOPCZ22 & xROBOPMZ50



# Table of Contents

<b>Part 1 Introduction</b>	<b>1</b>
1 Key Features .....	1
2 Essential Tools and WildKat Manager .....	1
3 Additional modules available at extra cost .....	2
ANPR Command Centre (SOFT1045) .....	2
RoboPlate FTP Server .....	3
RoboPlate RegWatch Widget (SOFT1046) .....	4
<b>Part 2 Connections</b>	<b>5</b>
<b>Part 3 Mounting</b>	<b>5</b>
1 ROBOPCZ22 .....	5
2 ROBOPMZ50 .....	6
<b>Part 4 Setup Options</b>	<b>7</b>
<b>Part 5 Camera Positioning</b>	<b>9</b>
1 Lighting .....	9
2 Field of View and Lens Positioning .....	9
3 Angle of View .....	9
<b>Part 6 Pre-Configuration</b>	<b>11</b>
1 SD Card .....	11
2 Finding and Assigning an IP address .....	11
3 Make a note of the IP Camera address .....	17
<b>Part 7 Camera Configuration</b>	<b>18</b>
1 Download WildKat Manager .....	18
2 Configuring the IP address using WildKat .....	19
3 Device Activation is via the web interface .....	22
4 Device Name and Number .....	23
5 Date and Time (DST and NTP) .....	24
6 Auto Reboot .....	25
7 Zoom Controls .....	25
8 Network .....	26
9 Port .....	27
10 Storage (FTP) .....	28
11 ANPR - Basic Settings .....	30
12 ANPR - Schedule .....	31
13 ANPR - Action .....	33
Audio - File Triggering .....	35
14 ANPR - Realtime Detection & Search .....	36



15 ANPR - B&W List .....	37
16 I/O Alarm .....	39
<b>Part 8 Tip - Adding to a ZIP NVR / DVR on a LAN</b>	<b>40</b>
<b>Part 9 Frequently Asked Questions</b>	<b>44</b>
1 Does it capture in rain, fog or snow? .....	44
2 Can non-standard characters be recognised? .....	44
3 Why do I get unexpected results? .....	44
4 What speed can vehicles travel? .....	44
5 Where do I get support? .....	44
<b>Part 10 Specification</b>	<b>45</b>
1 ROBOPCZ22 .....	45
2 ROBOPMZ50 .....	46
<b>Index</b>	<b>48</b>



## Introduction

The ROBOPCZ22 is eyeball style camera and the ROBOPMZ50 is a bullet style camera, which have real-time number plate detection and capture.

### 1.1 Key Features

- Captures Number Plates
- Extracts Number Plate data
- Black-White-Grey List
- Eyeball 6-22mm Lens, Bullet 5mm – 50mm
- Alarm Output
- Sends Emails
- Triggers Relays
- ONVIF Protocol
- Built In Mic\*
- IP66
- IR Illuminator
- RS485 Output
- Audio Out

\*Eyeball style camera only

### 1.2 Essential Tools and WildKat Manager

To install this product you will need:

- Laptop / Windows PC
- Screwdriver
- Drill
- 3mm hex key (Allen key - *Supplied*)
- PoE Switch / 12V DC power supply
- Ethernet CAT5/5e/6 Cable

#### WildKat - Camera Configuration Tool for Windows



In order to login & use a RoboPlate IP camera it will need setting to the same IP range as the network, available to download on Windows via this link below:-

<https://softcctv.com/store/Item/SOFT1709>



## 1.3 Additional modules available at extra cost

### 1.3.1 ANPR Command Centre (SOFT1045)

The software makes it easy to have more than just black and white lists, you can have multiple lists or groups, for example: VIP list, customer list, staff list and so on.

It is intended for slow moving traffic in gateways, driveways and entrances or stationary vehicles on a weigh bridge.

The maximum recommended vehicle speed is 5 mph so some speed control measure may be needed. Key features include ..

- Number plates captured as plain text
- Local image storage
- User definable actions

What happens when a number plate is accepted is determined by RoboPlate's Actions

An Action may perform any, or all, of the following tasks :

- Email
- Popup warnings with audio
- Trigger network connected VoiceOFF™ units
- Trigger network connected relay(s)



See [roboplate.com](http://roboplate.com) for more info.



### 1.3.2 RoboPlate FTP Server

RoboPlate ANPR Cameras stores captured number plates on a local SD card, however the software also facilitates an FTP function to save your data on a PC using this software.

Images are received from the RoboPlate Camera and the software stores them as .jpg files.

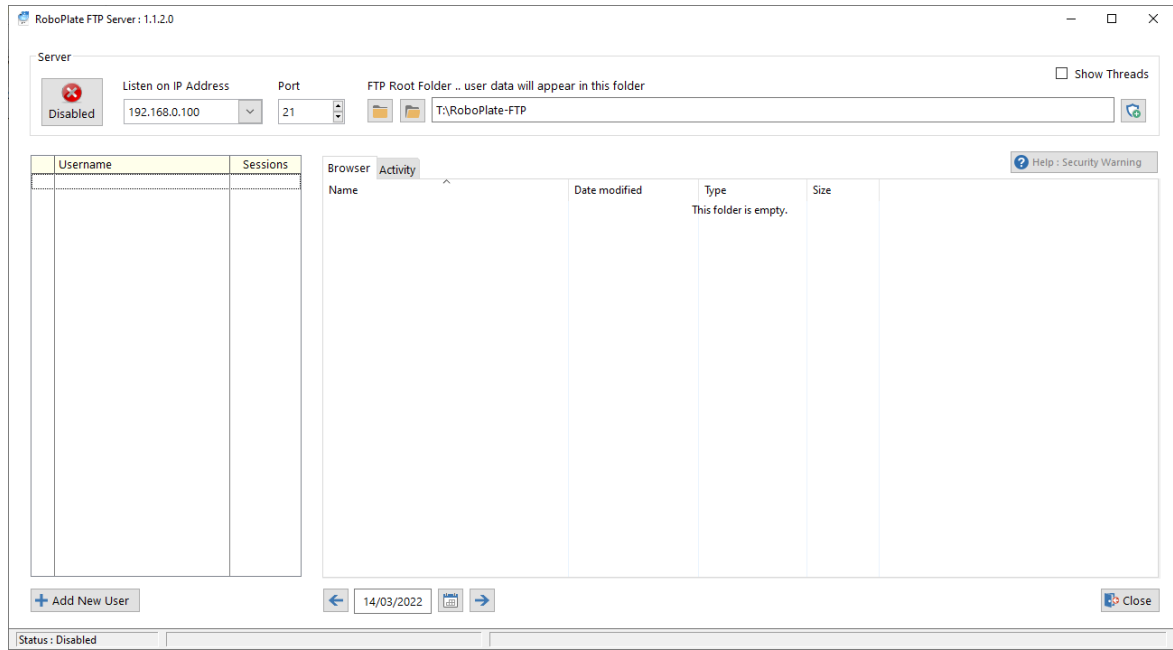

See [roboplate.com](http://roboplate.com) for more info.

### 1.3.3 RoboPlate RegWatch Widget (SOFT1046)

The software can display the live image and a pop up message from the camera when a notification is received from the camera.



See [roboplate.com](http://roboplate.com) for more info.



## Connections

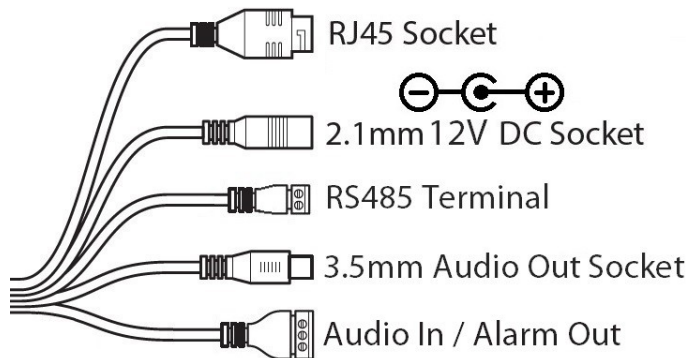

### Powering the camera

**Option 1** - Power the camera from 12V DC (via the 2.1mm DC Socket), the current consumption is 500mA (with IRs on)

The camera is polarity sensitive so connections must be correctly made.

**Option 2** - Power the camera using a PoE 48V RJ45 Socket

## Mounting

### 3.1 ROBOPCZ22

1. Using the Allen key supplied, loosen the two locking screws on the side of the camera. Rotate the collar and eyeball can then be removed.
2. Mount the base using the screws and wall plugs provided.
3. Position eyeball and the collar into position, and then secure the camera using the two locking screws.

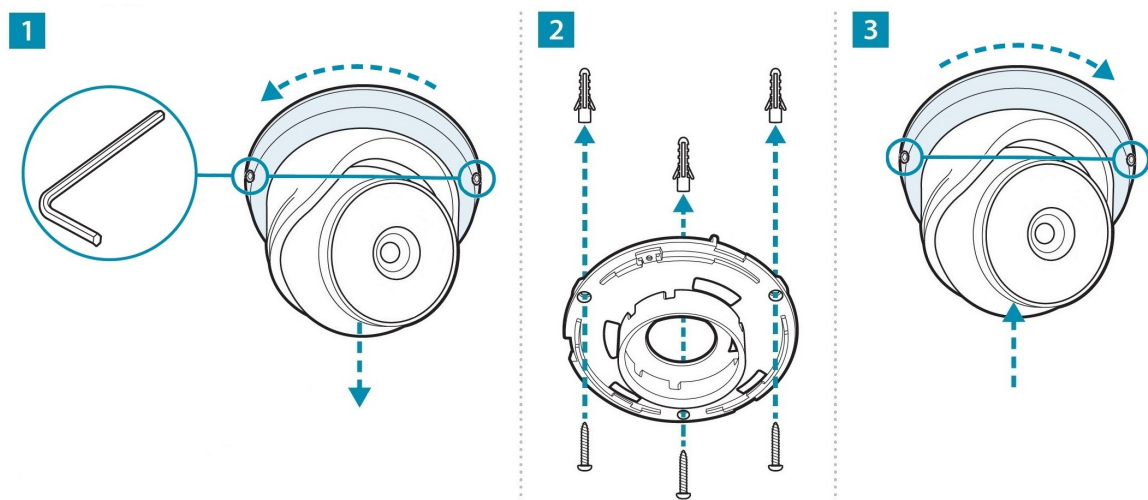





### 3.2 ROBOPMZ50

1. Mount the base using the screws and wall plugs provided.
2. Using the hex key supplied, loosen the locking screws. Position as required, tighten the locking screws to secure the camera.

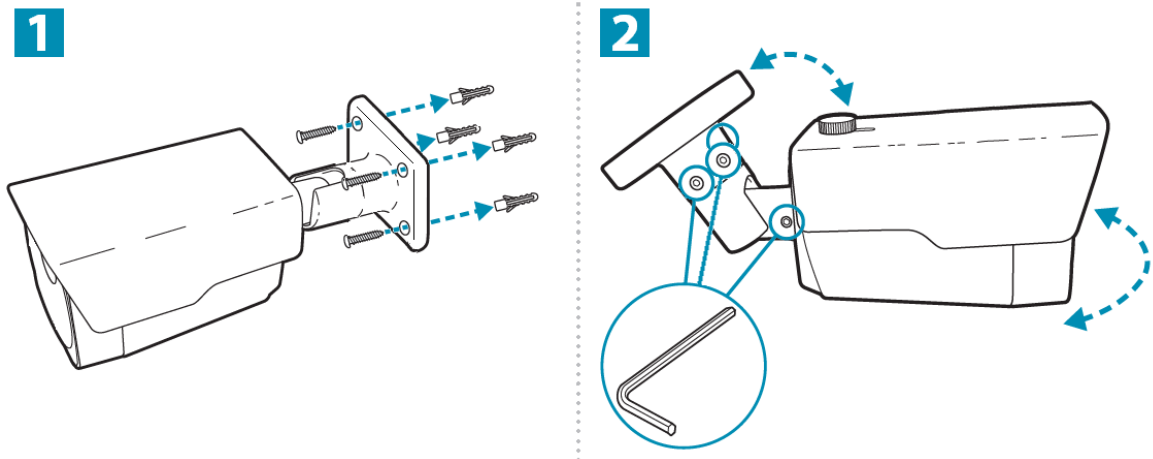



## Setup Options

IP Camera direct to a PC / Computer and powered via a 12V DC power supply

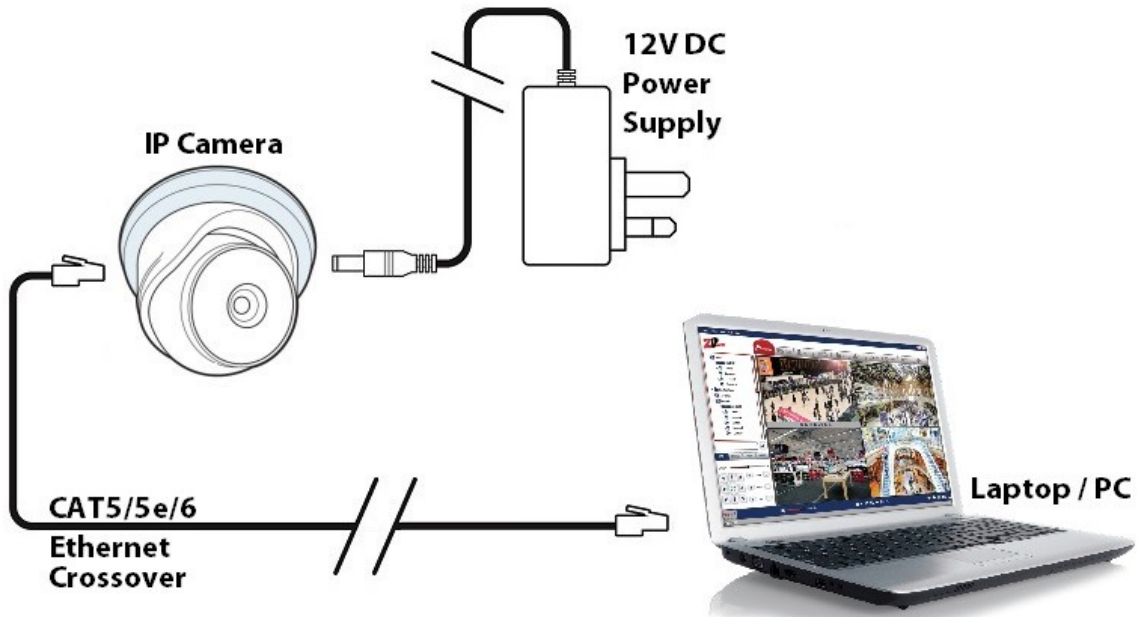

IP Camera connected to a network PoE Switch

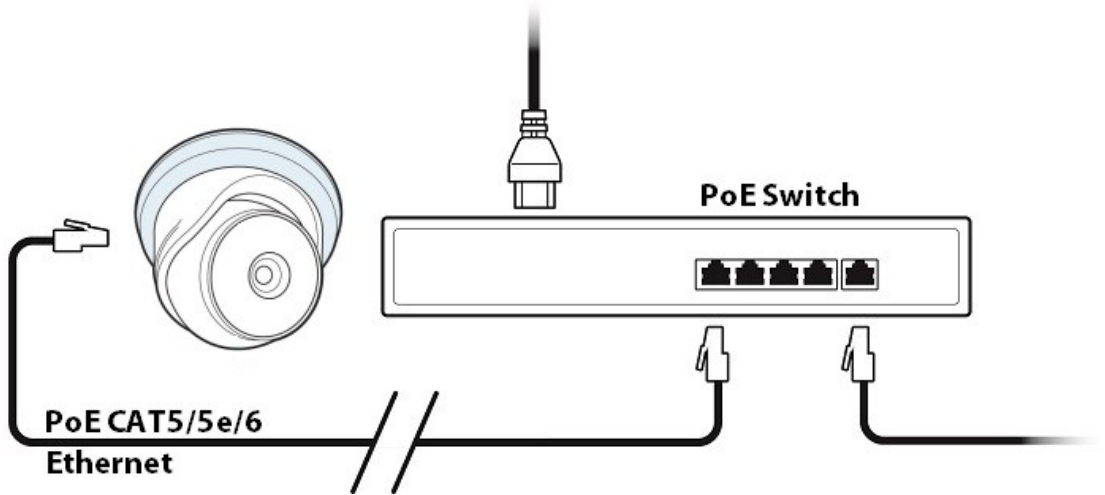



**IP Camera connected to a network non-PoE switch and powered via a 12V DC power supply**

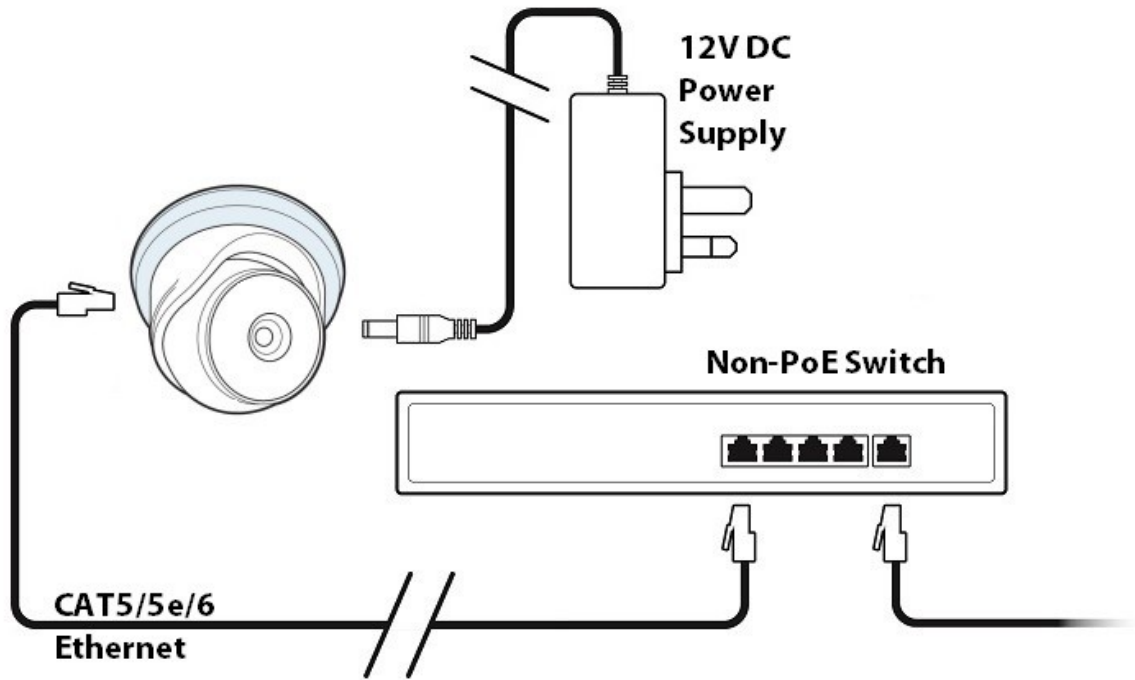



## Camera Positioning

This section describes some important information with regards to camera positioning, the field of view as determined by lens choice and angle of view. Some guidance follows advising how to improve performance.

### 5.1 Lighting

As ambient lighting is not sufficient for number plate recognition at dawn, dusk or night-time, the camera is equipped with built in Infra-Red (IR) LEDs.

Modern number plates are designed to be highly reflective so the IR light can take advantage of this fact at these times.

### 5.2 Field of View and Lens Positioning

A lens should be selected that results in a well cropped image eliminating unnecessary areas either side of the target vehicle, this will result in a larger more detailed view of the vehicle.

See [Zoom Controls](#)  for more information.

### 5.3 Angle of View

Camera positioning is very important, and where-ever possible the camera should be positioned in front of a vehicle so that the vehicle 'approaches' the camera, it can be slightly above or to one side.

It is important to achieve an angle of view whereby the target vehicle stays in the Area of Interest for as long as possible such that a number of consecutive, identical results can be obtained, this is not likely to happen with a high angle of incidence to the vehicle whereby the vehicle 'passes by'.



The diagram below shows typical positioning of the camera at which good results can be expected, as the angle of incidence increases, results will become less accurate.

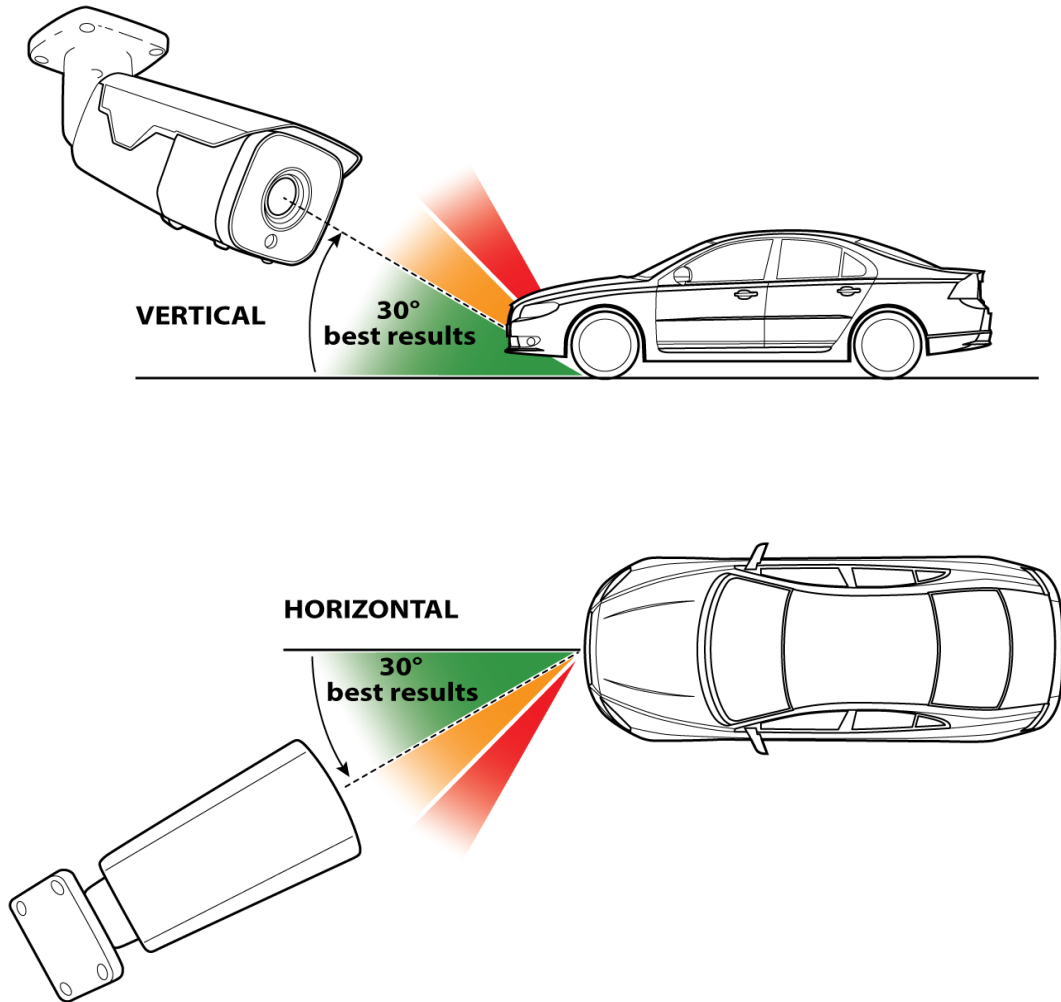



## Pre-Configuration

A windows based PC is required in order to follow these steps fully and setup the camera with an IP address using the WildKat Manager software.

### \*\*\* IMPORTANT \*\*\*

Some of the options seen in the browser (web interface) of the camera may not be compatible with this camera, the menu interface is designed to cover a range of different cameras so some features may not be supported.

## 6.1 SD Card

### \*\*\* IMPORTANT \*\*\*

Do not remove or format the SD Card, as the licence plate registration files and database are required in order for the camera to perform ANPR function.

Please contact your supplier / installer if the files on the SD Card are deleted or corrupt.

Recovery of the files may be provided on a chargeable basis and may also require the camera to be returned to the manufacturer.

## 6.2 Finding and Assigning an IP address

The best option for networking an IP camera is to assign the camera with a "static" IP address. There are multiple reasons why you would do this:

- The IP address is known and it will stay the same, making logging into the camera's web interface simpler and reliable.
- The IP address is known, therefore it is easier if the camera is to be added to a DVR or other device (or software).
- If the router is rebooted (or the DHCP server) it could assign a different IP address to the devices on the network, therefore making a static IP address preferred.

There are a few options to find and assign an IP address to your IP camera.

- **Option A.** Ask the on site IT department or network administrator for guidance on the IP address information to assign to the IP camera. Go to [Make a note of the IP Camera address](#) <sup>17</sup> onwards.

- **Option B.** Find a free IP address yourself using the instructions below on a best endeavours basis if option A is unavailable. (See Option B on next page for instructions)



**Option B - This section describes how to obtain a computers IP address, then using it find an available address to assign to a camera.**

1. Identify the network adaptor
2. Identify if the PC has a static IP or automatically assigned address
3. Identify the PCs current address
4. Using CMD find an available address for the camera

**1. Identify the network adaptor the PC is currently using.**

Close all programs currently in use.

Using the PCs search tool type *Network Connections*.

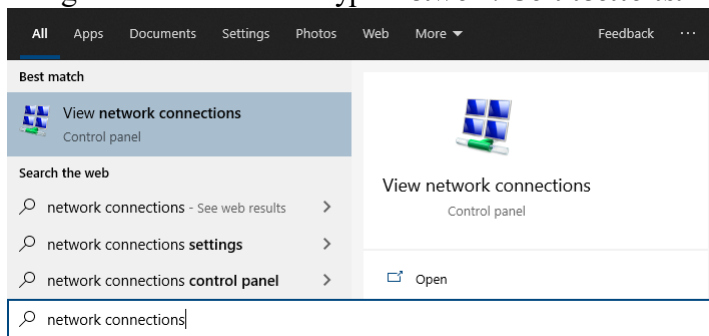

- If the hardware connection (Ethernet) is already connected, watch the icon change to indicate "unplugged" by simply unplugging the cable.

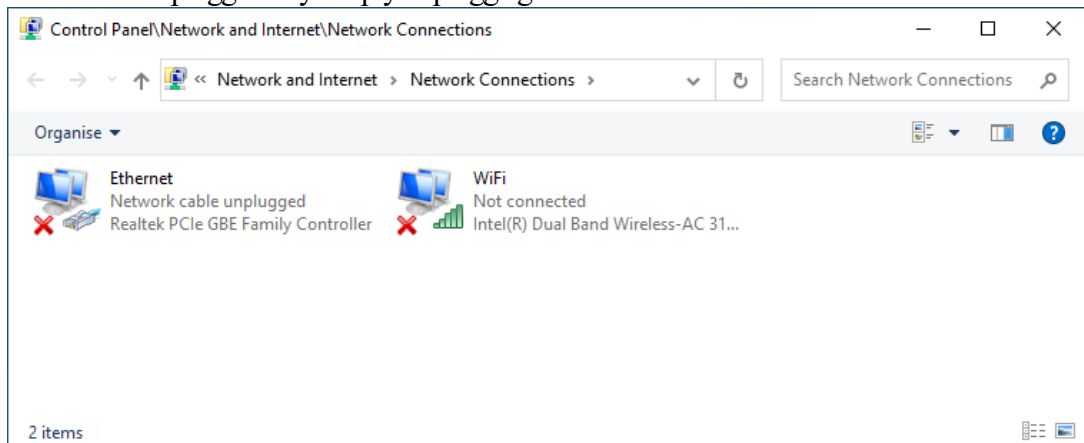

If you have multiple cabled adaptors, you can distinguish between them by connecting/disconnecting the cable, the status should change.



- And plug back in to determine if that adaptor is being used, below shows the adaptor ***Ethernet*** being used.

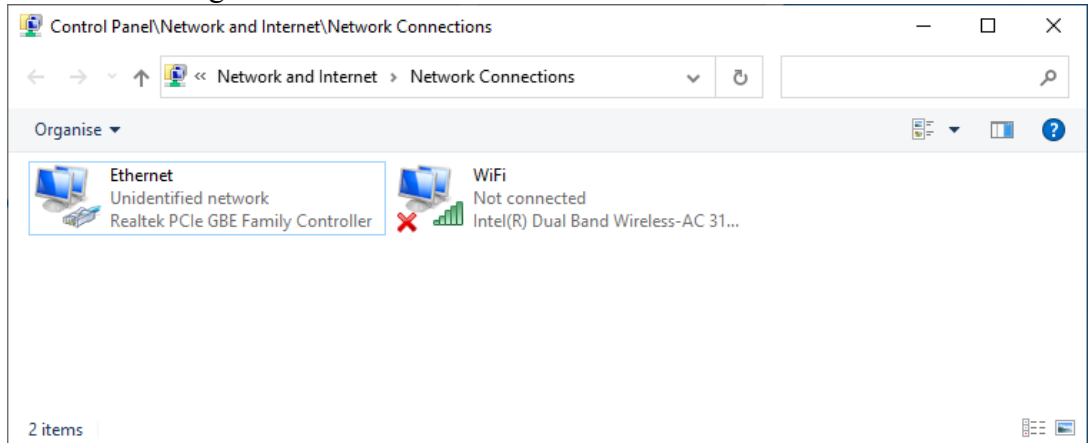

- If using WiFi then ensure all other adaptors are unplugged and disabled (right click, then select disable).

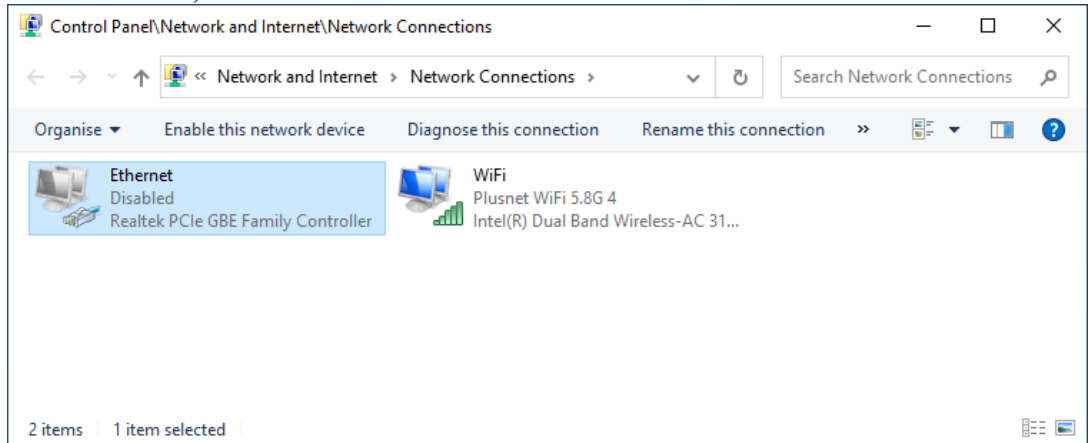

Make a note of the current "Connections:" type by name : \_\_\_\_\_

For example **Ethernet**





## 2. Identify if the PC is using a manually assigned static address or if the PC has obtained the address automatically using "DHCP".

Right-click on the connection type, select *Properties*.

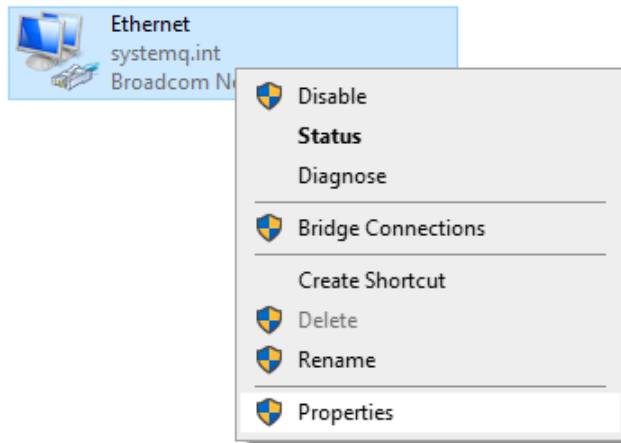

Double click on *Internet Protocol Version 4 (TCP/IPv4)*.

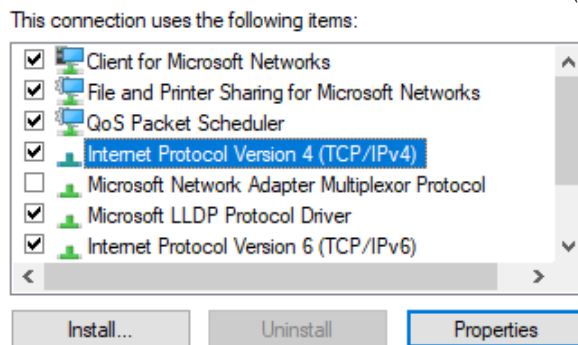

- If *Obtain an IP address automatically* is selected then proceed to step 3.

Obtain an IP address automatically

Use the following IP address:

IP address:	<input type="text" value="."/> <input type="text" value="."/> <input type="text" value="."/> <input type="text" value="."/>
Subnet mask:	<input type="text" value="."/> <input type="text" value="."/> <input type="text" value="."/> <input type="text" value="."/>
Default gateway:	<input type="text" value="."/> <input type="text" value="."/> <input type="text" value="."/> <input type="text" value="."/>

- If *Use the following IP address* is selected then proceed to step 4.

Obtain an IP address automatically

Use the following IP address:

IP address:	<input type="text" value="192"/> <input type="text" value="."/> <input type="text" value="168"/> <input type="text" value="."/> <input type="text" value="1"/> <input type="text" value="."/> <input type="text" value="10"/>
Subnet mask:	<input type="text" value="255"/> <input type="text" value="."/> <input type="text" value="255"/> <input type="text" value="."/> <input type="text" value="255"/> <input type="text" value="."/> <input type="text" value="0"/>
Default gateway:	<input type="text" value="192"/> <input type="text" value="."/> <input type="text" value="168"/> <input type="text" value="."/> <input type="text" value="1"/> <input type="text" value="."/> <input type="text" value="254"/>



### 3. Find the PC's current IP address.

Using the PC's search tool type *CMD* then click enter to launch command prompt.

Type in *IPCONFIG* and click enter.

Look for the adaptor name identified in step 1, for example *Ethernet adaptor*. Scroll up or down if necessary

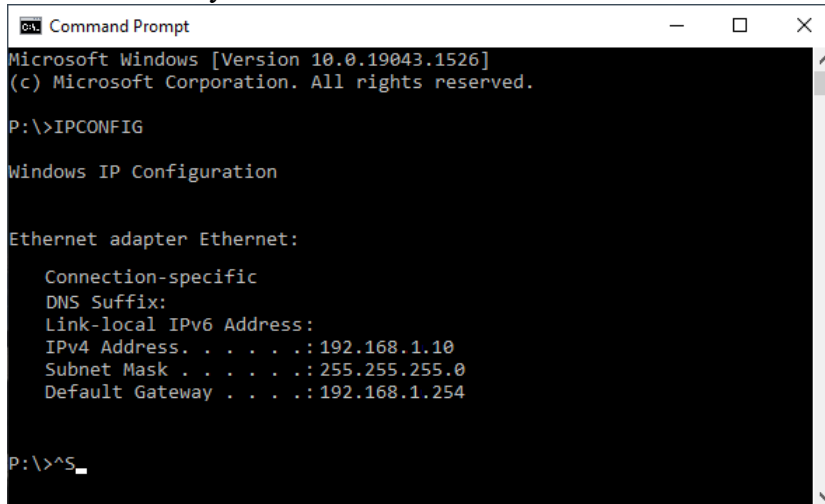

```

Command Prompt
Microsoft Windows [Version 10.0.19043.1526]
(c) Microsoft Corporation. All rights reserved.

P:\>IPCONFIG

Windows IP Configuration

Ethernet adapter Ethernet:

    Connection-specific DNS Suffix:
    Link-local IPv6 Address . . . . .:
    IPv4 Address. . . . .:192.168.1.10
    Subnet Mask . . . . .:255.255.255.0
    Default Gateway . . . . .:192.168.1.254

P:\>^S_
    
```

### 4. Make a note of this adaptors address settings here:

**IP Address:** \_\_\_\_\_

**Subnet Mask:** \_\_\_\_\_

**Gateway:** \_\_\_\_\_

## 5. Next try find an available IP address to assign to the camera using the ping command tool.

Use CMD (Command prompt) type in *ping*, space and then using the first three segments of the IP address of the PC, substituting the last segment with 250 at the end, then select enter.

For example: *ping 192.168.1.250*

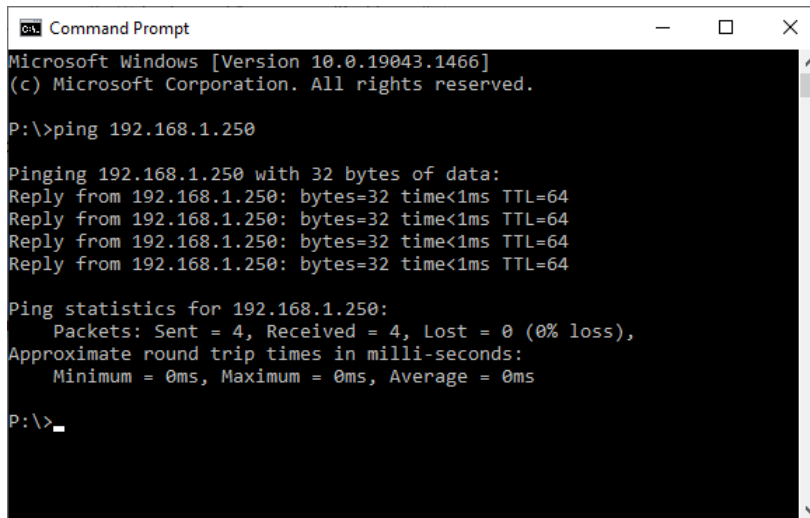

```
Command Prompt
Microsoft Windows [Version 10.0.19043.1466]
(c) Microsoft Corporation. All rights reserved.

P:\>ping 192.168.1.250

Pinging 192.168.1.250 with 32 bytes of data:
Reply from 192.168.1.250: bytes=32 time<1ms TTL=64
Reply from 192.168.1.250: bytes=32 time<1ms TTL=64
Reply from 192.168.1.250: bytes=32 time<1ms TTL=64
Reply from 192.168.1.250: bytes=32 time<1ms TTL=64

Ping statistics for 192.168.1.250:
    Packets: Sent = 4, Received = 4, Lost = 0 (0% loss),
    Approximate round trip times in milli-seconds:
        Minimum = 0ms, Maximum = 0ms, Average = 0ms

P:\>
```

- If the reply is *Reply from 192.168.1.250....* then the address is already taken on the network.

Simply search again but minus 1 from the last number.

For example: *ping 192.168.1.249* until *Destination host unreachable* is the reply.

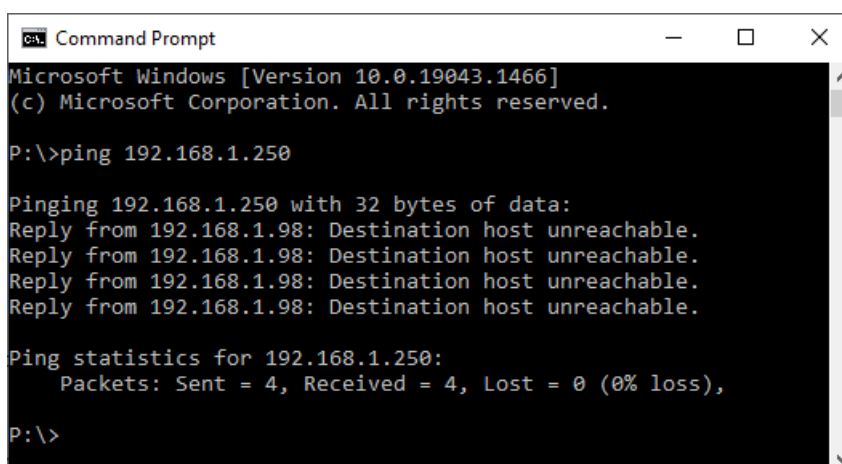

```
Command Prompt
Microsoft Windows [Version 10.0.19043.1466]
(c) Microsoft Corporation. All rights reserved.

P:\>ping 192.168.1.250

Pinging 192.168.1.250 with 32 bytes of data:
Reply from 192.168.1.98: Destination host unreachable.
Reply from 192.168.1.98: Destination host unreachable.
Reply from 192.168.1.98: Destination host unreachable.
Reply from 192.168.1.98: Destination host unreachable.

Ping statistics for 192.168.1.250:
    Packets: Sent = 4, Received = 4, Lost = 0 (0% loss),

P:\>
```

- If the message *Destination host unreachable* displays then this address is free to use for the IP camera.

Proceed to [Make a note of the IP Camera address](#) <sup>17</sup>



### 6.3 Make a note of the IP Camera address

**IP Address:** \_\_\_\_\_

**Subnet Mask:** \_\_\_\_\_

**Gateway:** \_\_\_\_\_

## Camera Configuration

**This section describes how to set the cameras IP address using WildKat Manager**

1. Search for the camera
2. Set the cameras IP address

### **Then setup the camera browser interface**

1. Activate the IP camera with a new password
2. Set the cameras device name and number
3. Setup Date and Time, Network, Port & ANPR features

Power the camera and connect the network or PoE (the camera takes approximately 1 minute to boot).

## **7.1 Download WildKat Manager**

**WildKat - Camera Configuration Tool for Windows**



Download the WildKat Manager from:

<https://softcctv.com/store/Item/SOFT1709>



## 7.2 Configuring the IP address using WildKat

1. Launch the WildKat Manager, then select *Search*.

2. Select *Refresh List*.

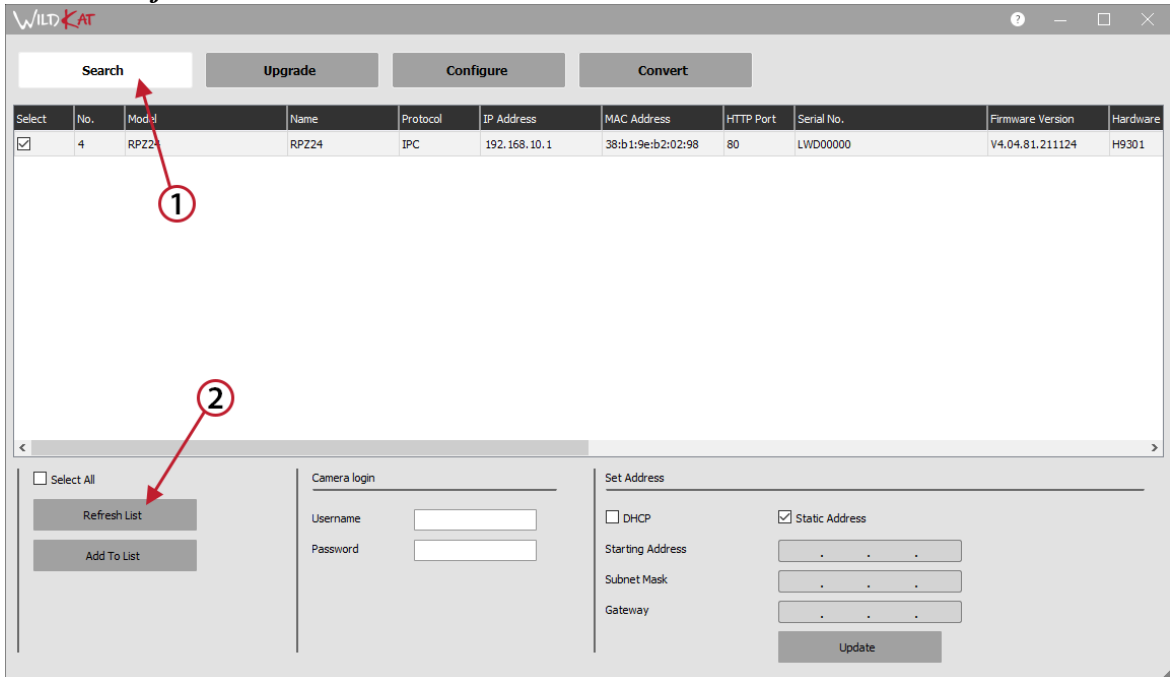

The screenshot shows the WildKat Manager interface. At the top, there are buttons for 'Search', 'Upgrade', 'Configure', and 'Convert'. Below these is a table with the following data:

Select	No.	Model	Name	Protocol	IP Address	MAC Address	HTTP Port	Serial No.	Firmware Version	Hardware
<input checked="" type="checkbox"/>	4	RPZ22	RPZ24	IPC	192.168.10.1	38:b1:9e:b2:02:98	80	LWD00000	V4.04.81.211124	H9301

Below the table, there are three main sections: 'Select All' with 'Refresh List' and 'Add To List' buttons; 'Camera login' with 'Username' and 'Password' fields; and 'Set Address' with 'DHCP' and 'Static Address' options, 'Starting Address', 'Subnet Mask', and 'Gateway' fields, and an 'Update' button. Red arrows and circles highlight the 'Search' button (1) and the 'Refresh List' button (2).



3. Tick the camera found in the list.
4. Enter the pre-activation *Username and Password* for the camera.

Default login details are:-

Default IP	<b>192.168.10.1</b>
User Name	<b>admin</b>
Password	<b>777777</b>

5. Tick *Static Address*
6. Enter the new IP address information into *Starting Address, Subnet Mask* and *Gateway*.
7. Select *Update*.

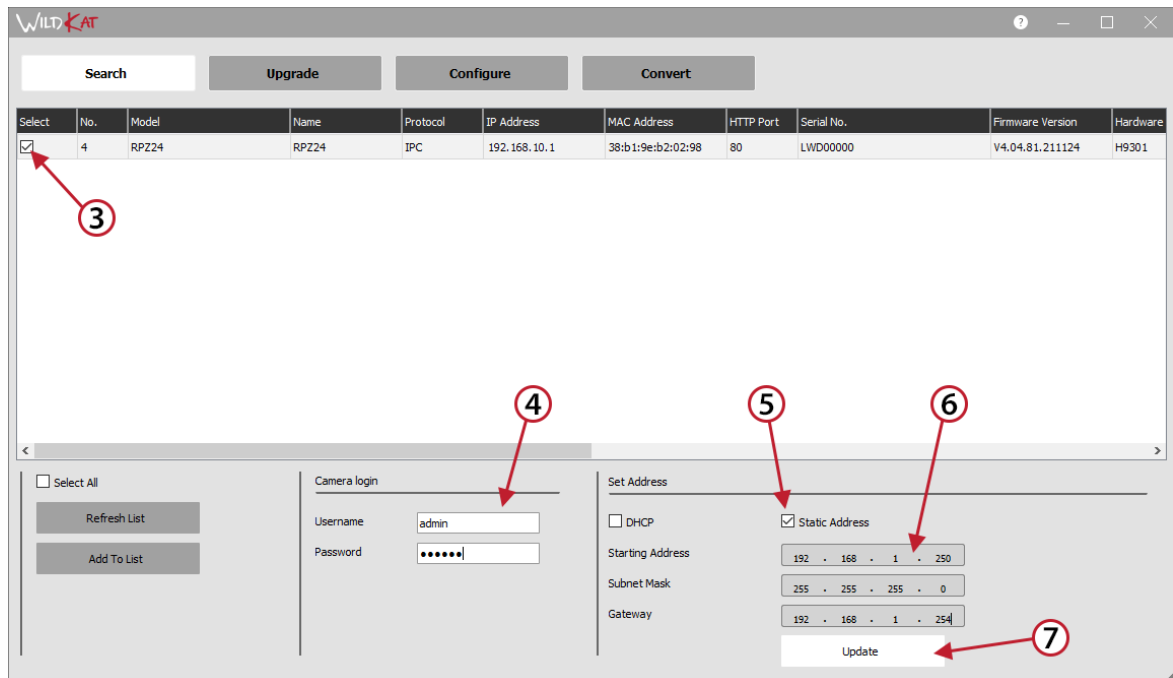

The screenshot shows the WILD KAT web interface. At the top, there are buttons for 'Search', 'Upgrade', 'Configure', and 'Convert'. Below is a table with columns: Select, No., Model, Name, Protocol, IP Address, MAC Address, HTTP Port, Serial No., Firmware Version, and Hardware. The first row is selected, with a red arrow and circled number 3 pointing to the 'Select' checkbox. Below the table, there are three main sections: 'Camera login' with fields for 'Username' (admin) and 'Password' (777777), a red arrow and circled number 4 pointing to the password field; 'Set Address' with a 'DHCP' checkbox (unchecked) and a 'Static Address' checkbox (checked), a red arrow and circled number 5 pointing to the 'Static Address' checkbox; and three input fields for 'Starting Address' (192.168.1.250), 'Subnet Mask' (255.255.255.0), and 'Gateway' (192.168.1.254), with red arrows and circled numbers 6 and 7 pointing to the 'Starting Address' and 'Update' button respectively. An 'Update' button is located at the bottom right of the 'Set Address' section.



8. Read the message carefully, check for '**1 set successfully**', if the message displays '**0 set successfully**' then the details entered in the previous steps were incorrect or the camera is no longer connected. Go back to step 2.

The screenshot shows the WILD KAT web interface. At the top, there are buttons for 'Search', 'Upgrade', 'Configure', and 'Convert'. Below these is a table with columns: Select, No., Model, Name, Protocol, IP Address, MAC Address, HTTP Port, Serial No., Firmware Version, and Hardware. The table contains one entry: No. 4, Model RPZ24, Name RPZ24, Protocol IPC, IP Address 192.168.10.1, MAC Address 38:b1:9e:b2:02:98, HTTP Port 80, Serial No. LWD00000, Firmware Version V4.04.81.211124, and Hardware H9301. A modal dialog box titled 'WILD KAT Batch Set IP' is open in the center, displaying a blue progress bar and the text: 'IP setting completed. 1 camera(s) selected, 1 set successfully.' A red circle with the number 8 and an arrow points to this message. Below the dialog, there are sections for 'Camera login' (Username: admin, Password: masked) and 'Set Address' (DHCP: unchecked, Static Address: checked, Starting Address: 192.168.1.250, Subnet Mask: 255.255.255.0, Gateway: 192.168.1.254). There is an 'Update' button at the bottom right.

9. Select **Refresh List** to confirm the cameras IP address has updated.

This screenshot shows the same WILD KAT web interface as the previous one, but the 'Batch Set IP' dialog box is closed. A red circle with the number 9 and an arrow points to the 'Refresh List' button in the bottom left corner of the interface. The table and other settings remain the same as in the previous screenshot.





## 7.3 Device Activation is via the web interface

1. Right-click and select *Open Browser*.

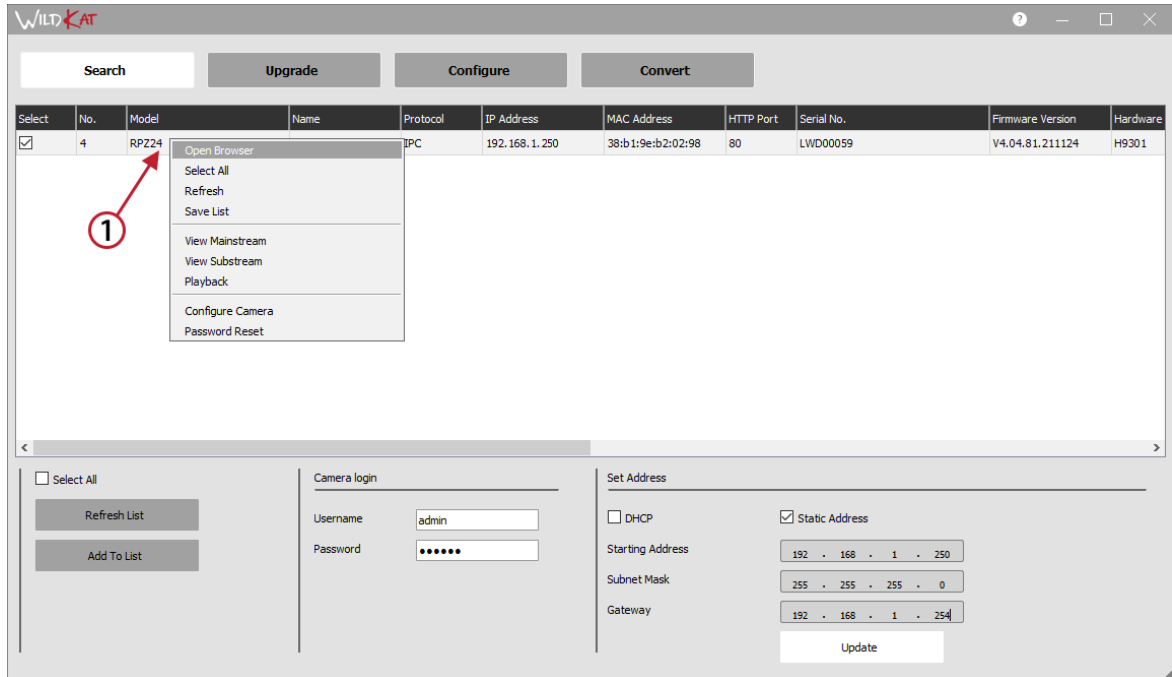

2. Enter a new password into the activation page, select *Confirm*.

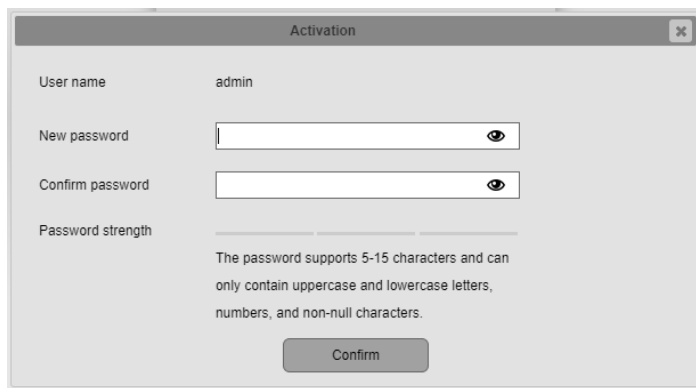

3. Enter the user name and new password and login to the camera.



## 7.4 Device Name and Number

Before configuring any settings the camera requires a device name and device number.

This ensures that each camera is individual and when multiple cameras are used on one site then each camera can be easily identified.

Navigate to: *Configuration > System > General*

The example below shows the Device name set as **Office** and the Device/Camera number as **01**.

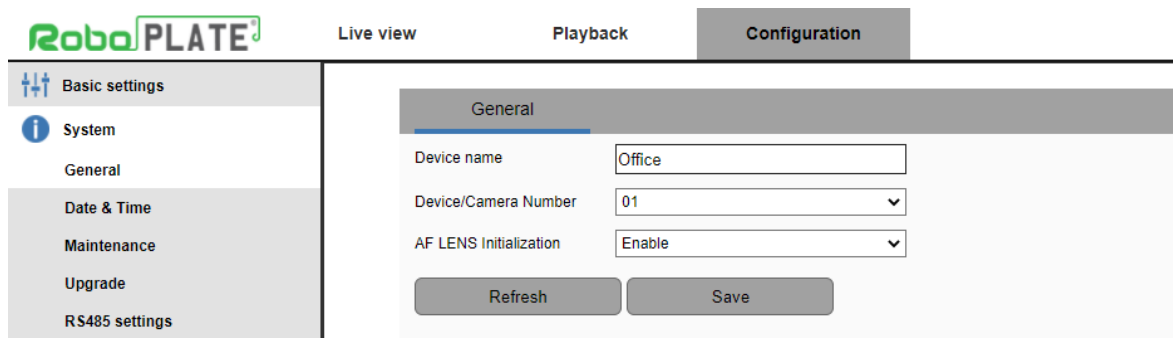

Field Name	Description
Device Name	Enter a short name here to identify the camera.
Device/Camera Number	If using multiple similarly named cameras, identify the second and subsequent cameras from the drop down list.  When changing the device number a popup appears asking if FTP and Alarm host defaults should be initialised, select allow.
Click <b>Save</b> after making any changes	

The camera will then reboot (takes approximately 1 minute to reboot) and apply the name and number to the FTP folder structure.

This is also used to initialize the alarm server i.e the port number will be set to 5000 plus the device number. So the port for device number 01 is 5001, the second 5002 and so on.





## 7.5 Date and Time (DST and NTP)

The camera does not have an internal battery to power its real time clock so it is very important that an external time source is configured to sync against both during its power-up sequence and to maintain accuracy.

Navigate to: **Configuration > System > Date & Time**

Ensure the camera has internet access if using an online time source.

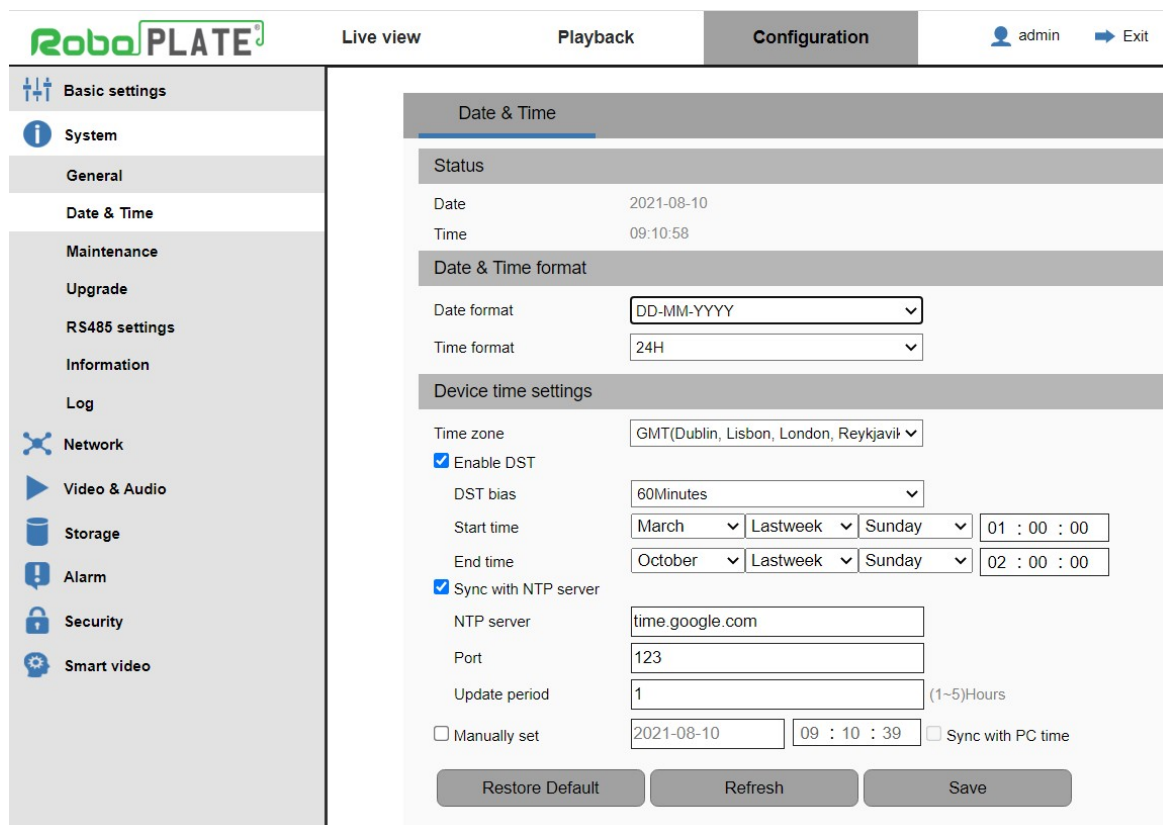

Field Name	Description
Time Zone	Ensure GMT is selected for use in the UK
Enable DST	Ensure DST is enabled with the appropriate start and end dates.
Sync with NTP Server	Ensure Sync with NTP server is enabled.  If the camera will be allowed Internet access then you may accept the default <i>time.google.com</i> as a time source, otherwise you should make arrangements to provide an alternative PC based time source on your network.
Manually Set	This option is not recommended for long term deployment. If there is a power cut, the camera will not be able to initialise its date/time after boot-up.
Click <b>Save</b> after making any changes	



## 7.6 Auto Reboot

It is important to ensure the camera performs an "auto reboot" daily. This helps maintain and provide consistent ANPR results.

Navigate to: **Configuration > System > Maintenance**

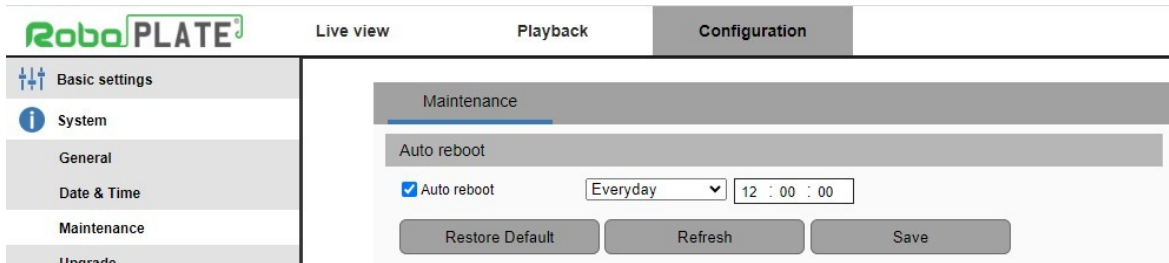

## 7.7 Zoom Controls

The RoboPlate Cameras have built-in motorised zoom and focus controls.

To adjust the zoom Navigate to **Live View**

Then select the Zoom + or - to adjust the zoom. The camera will automatically focus once the button is de-pressed.

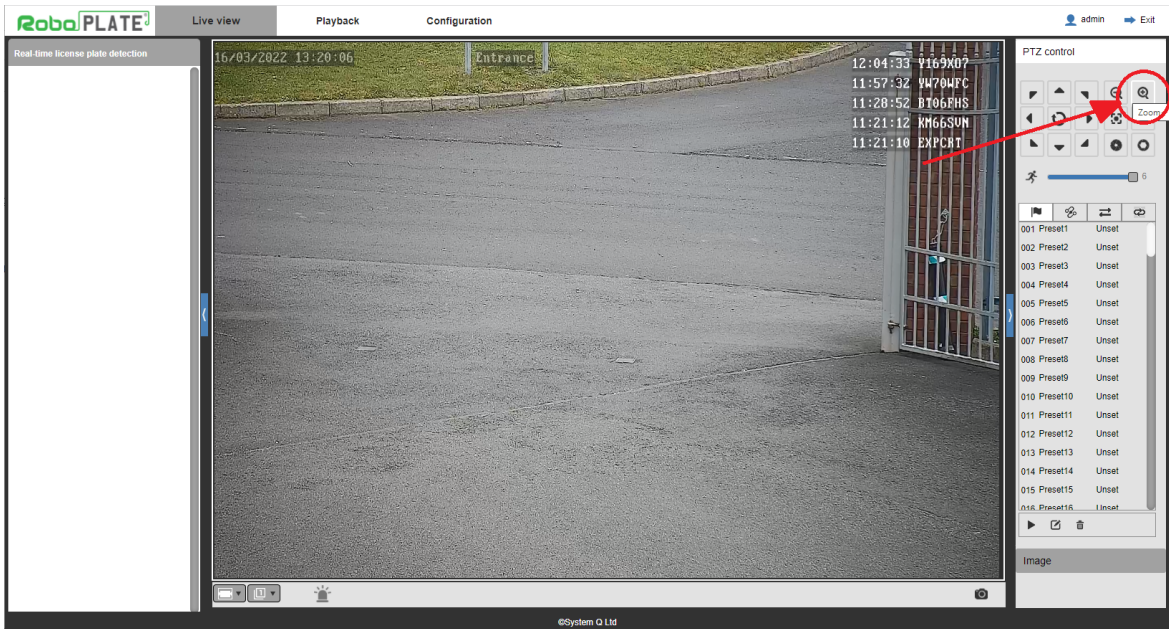



## 7.8 Network

If not set already, an IP address, subnet mask and gateway is required to be set for full network access to the camera.

When using an alphabetical NTP server such as time.google.com, then you must also specify a DNS server.

Navigate to: **Configuration > Network > TCP/IP**

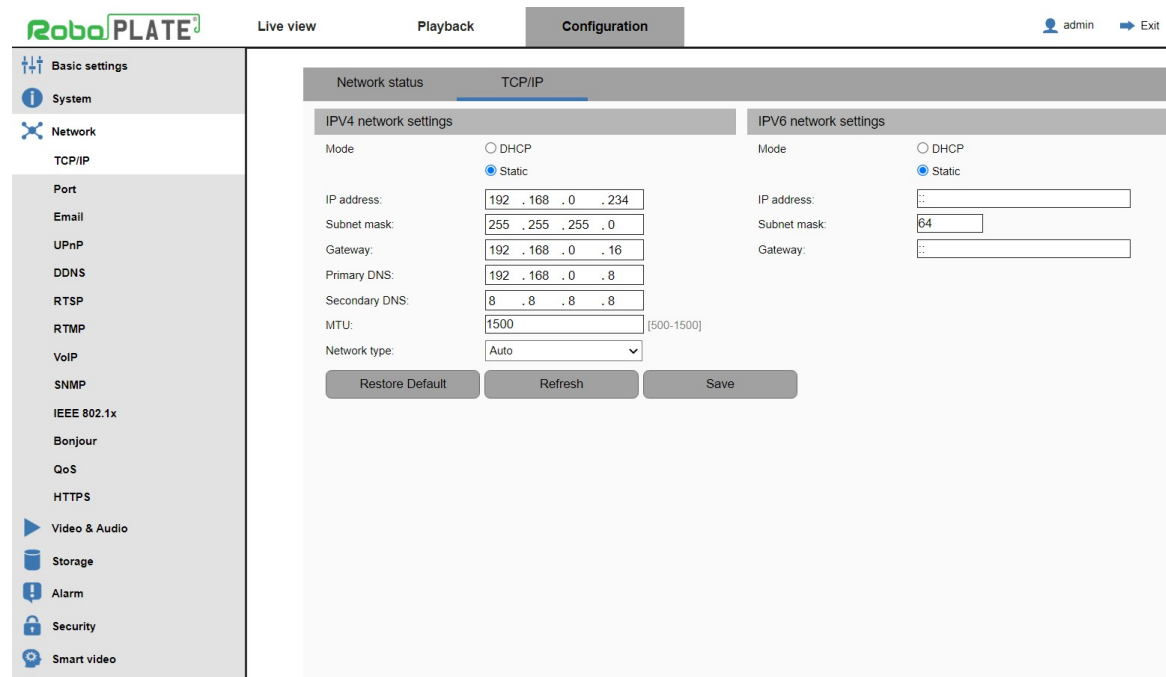

Field Name	Description
<b>IPv4 Settings</b>	
DHCP or Static	The best option for networking an IP camera is to assign the camera with a "static" IP address (ie: fixed) IP address for use on your network in preference to using DHCP. This ensures the camera powers up on the same address every time.
IP Address	When static : Specify the actual address you want the camera to use.
Subnet mask	When static : Specify the subnet mask you want the camera to use.
Gateway	When static : Specify the gateway address you want the camera to use.
Primary DNS	When static : Specify the primary DNS server by address that you want the camera to use. This is very important when using specifying an alphabetical NTP time source such as time.google.com
Click Save after making any changes	



## 7.9 Port

Field Name	Description
<b>Port settings</b>	
HTTP port	(Port 80 as default) the commonly used internet communication protocol for the web interface.
HTTPS port	(Port 443 as default) standard protected web browser port which encrypted .
RTSP port	(Port 1240 as default) stands for real time streaming protocol, used for localised streaming of IP cameras or media.
Service port	(Port 8240 as default) used for the connection by proprietary software.
Hikvision port	(Port 8000 as default) is the standard port used by Hikvision software and hardware for the main connection to the product. This port is also used for the RoboPlate Command Centre Software.
RTMP port	(Port 1935 as default) is a streaming protocol typically used for broadcasting video and audio over the Internet.
<b>Protocol settings</b>	
ONVIF	Enable to connect using the industry open standard (ONVIF) for IP (Typically uses the HTTP port)
HIK	Enable to connect via the HikVision Port. This port is required by the RoboPlate add-on software.
Click <b>Save</b> after making any changes	



## 7.10 Storage (FTP)

Navigate to: *Configuration > Storage > FTP*

The camera is able to send images captured during the recognition process to an FTP server.

Images are named in this manner: List-Date-Time-Plate.jpg  
 Where List = BWG, date = yyyyymmdd and time = hhmmss.

Example:-

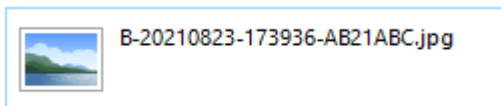

A RoboPlate branded FTP server package is available - [RoboPlate FTP Server](#)

When using an alphabetical FTP server such as time.google.com, then you must also specify a DNS server.

Field Name	Description
Server Address	Enter the IP address of the FTP server. Notes: 1. Populating this field enables FTP 2. Clear this field to disable FTP
Port	The standard port = 21 Use the port as specified by the FTP server.



xROBOPCZ22 & xROBOPMZ50

Username	Enter a username as specified by the FTP server.
Password	Enter the password for the username as specified by the FTP server.
Remote Path	<p>Leave this field blank.</p> <p>Management of the folder structure on the FTP server should be handled by the server and not specified here.</p>
Click <i>Save</i> after making any changes	





## 7.11 ANPR - Basic Settings

Navigate to: *Configuration > Smart Video > ANPR > Basic Settings*

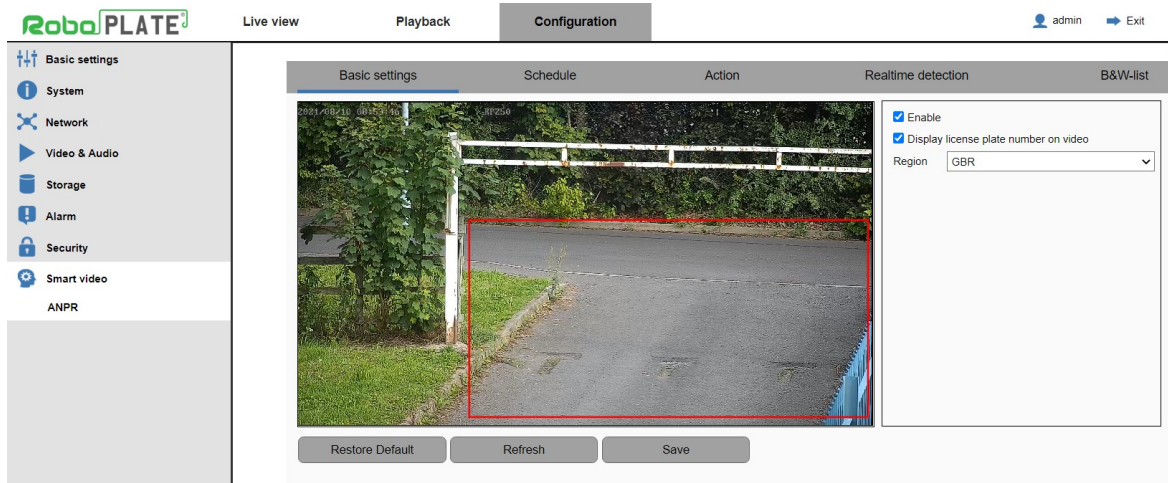

The red box indicates the area of interest.

Click and drag with the mouse to draw this from top left down to bottom right, a registration plate must be visible in the box for detection.

Careful positioning of the box can help eliminate unwanted results by restricting the area of interest.

Field Name	Description
Enable	Check to enable Ensure this box is checked to enable ANPR processing.
Display plate on the video	If enabled, 5 x lines of plate information are overlaid in the top right hand corner of the live video indicating the most recent results.
Region	Selecting the geographical region identifies a bias that the ANPR engine can apply to the plate detection logic, it <b>does not</b> specify or limit the results to one country.
Click <b>Save</b> after making any changes	



## 7.12 ANPR - Schedule

Navigate to: *Configuration > Smart Video > ANPR > Schedule*

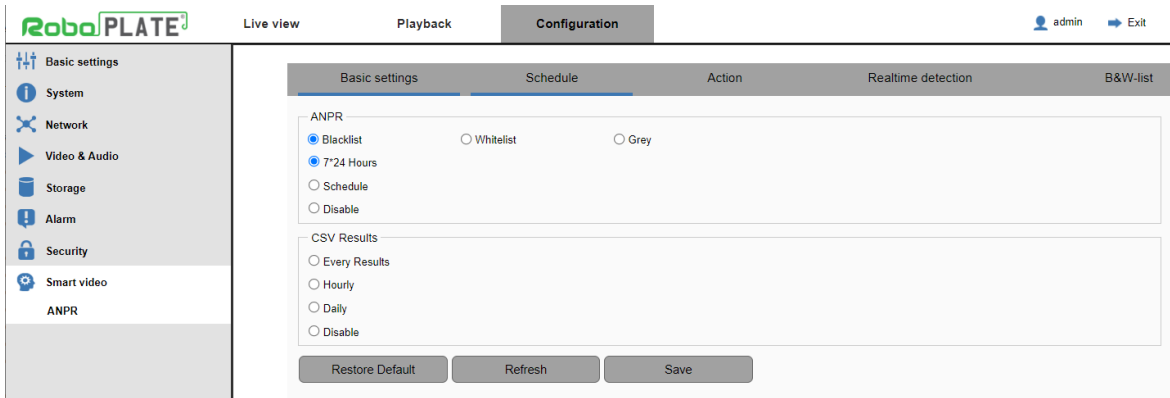

Schedule page will have the schedule selected on Blacklist, so ensure before making any changes to the schedule the right list option is selected.

As default the cameras ANPR schedule is set to trigger 7\*24 Hours, meaning it will constantly detect number plates all day, every day.

For a custom ANPR schedule, see the example below where the camera is set to record ANPR results during opening times 8am - 5pm, Monday to Friday.

1. Click **Setup** on the right, then tick the days required to trigger the camera.
2. Enter the start and end time in Period 1, then select **Save**.

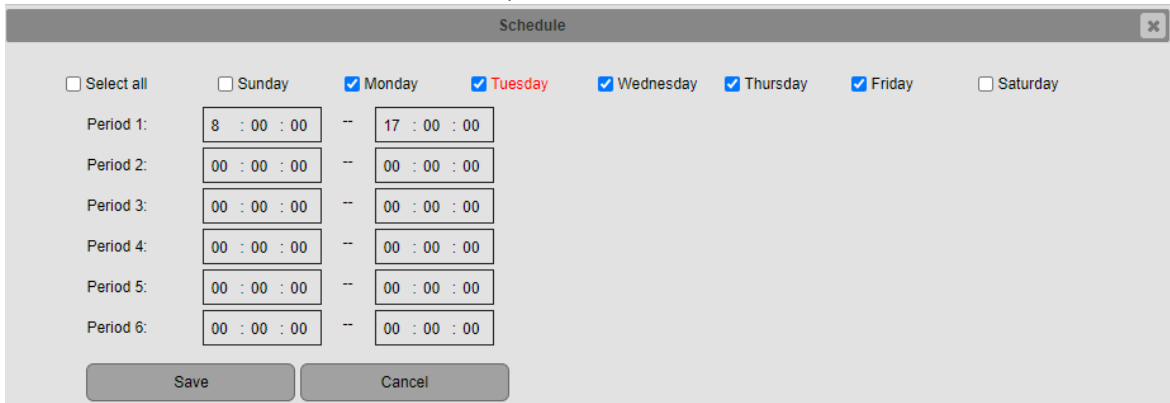



3. The enabled times for the schedule will show blue, Click **Save** at the bottom to apply the Schedule.

Field Name	Description
<b>ANPR</b>	
7*24 Hours	As default the cameras ANPR schedule is set to trigger 7*24 Hours, meaning it will constantly detect number plates all day, every day.
Schedule	A custom ANPR schedule can be configured.
Disable	Disable the ANPR schedule completely, registered ANPR number plates will not be recorded.
<b>CSV Results*</b>	
Every Results	Exports the file after every result.
Hourly	Exports the file each hour.
Daily	Exports the file just after midnight.
Disable	Turns off the CSV export.
Click <b>Save</b> after making any changes	

\*For the CSV files to be sent this requires [Storage \(FTP\)](#) to be setup. The CSV file is for use with other software or an external program like excel.



## 7.13 ANPR - Action

Navigate to: *Configuration > Smart Video > ANPR > Action*

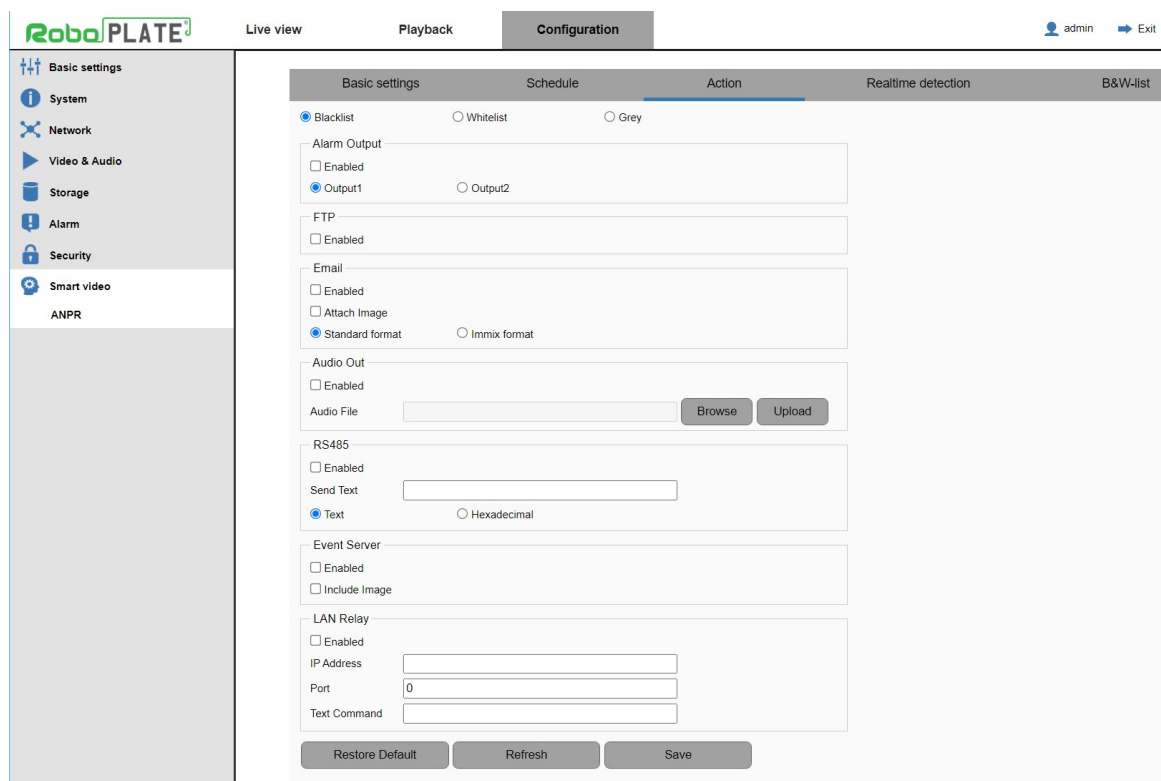

To add number plates to the Blacklist, Whitelist, navigate to [ANPR - B&W List](#)<sup>37</sup>

The camera can be set to trigger a specified action when a number plate is recognised either on the **Blacklist**, **Whitelist** or is **Grey**\*

\***Grey** means the camera has detected an unrecognised numberplate (not currently entered into the B&W-list).

For example:

- The camera can be setup to trigger an alarm output 1 to open a gate when a whitelist numberplate is recognised.
- Or setup so when a blacklist numberplate is detected it can trigger an audio message to play a warning.
- When a grey number plate is detected it could send an email and trigger alarm output 2 to warn gatehouse staff.

Field Name	Description
<b>Blacklist</b>	Select to configure the action handling for when a <b>Blacklist</b> numberplate is detected.
<b>Whitelist</b>	Select to configure the action handling for when a <b>Whitelist</b> numberplate is detected.



<b>Grey</b>	Select to configure the action handling for when a <i>Grey</i> (unrecognised) numberplate is detected.
<b>Alarm Output</b>	
Enabled	Ensure this box is checked to enable the Alarm Output.
Output1	Select alarm output 1 (alarm output 2 not used on this model).
<b>FTP</b>	
Enabled	Ensure this box is checked to enable the FTP trigger. Setup the FTP settings in order to trigger, see <a href="#">Storage (FTP)</a> <sup>28</sup> .
<b>Email</b>	
Enabled	Check to enable email Clear the box to disable. Email must be configured beforehand.
Attach Image	Check to enable image attachment
Standard format	Produces generic email text that includes the plate and black/white/grey list identifier
Immix format	Produces email text capable of being interpreted by <i>Immix</i> monitoring software
<b>Audio Out</b>	
Enabled	Ensure this box is checked to enable Audio Output trigger.
Audio File	Select to search and upload audio file.  <b>Note - The audio file format required is PCM 8Kbps MONO.</b>  For more information see <a href="#">Audio - File Triggering</a> <sup>35</sup>
<b>RS485</b>	
Enabled	Ensure this box is checked to enable the RS485 trigger. The RS485 output can trigger products such as the VoiceOFF, or 3rd party products that can interpret RS485 data, such as a PTZ with Hexadecimal data.
Send Text	Enter in text or hexadecimal to this field.
Text	Select this box to trigger text out from the RS485.
Hexadecimal	Select this box to trigger hexadecimal out from the RS485.
<b>Event Server</b>	
Enabled	Ensure this box is checked to enable the Event Server trigger.
Include Image	Ensure this box is checked for the number plate image to send to the event server.
<b>LAN Relay</b>	
Enabled	Ensure this box is checked to enable the LAN Relay trigger. This can be used with a 3rd Party LAN Relay which can



	receive text or used with the RegWATCH (SOFT1046) software. See <a href="#">Additional modules available at extra cost</a> 
IP Address	Enter the IP address of LAN device or receiver.
Port	Enter the port number of the LAN device or receiver.
Text Command	Enter the text to be sent to the LAN relay. This is a free text field. Content is interpreted as ASCII, there is no HEX/binary conversion.
<p>The LAN relay should act as a TCP/IP server.                  Whilst this functionality was originally intended for use with a network attached relay (to trigger a gate release), this may be any device or software capable of accepting an inbound connection on a specified port.                  Authentication, ie: use of a username and password is not expected.</p>	
Click <b>Save</b> after making any changes	

**Note:**

When configuring these actions, make changes on a per-list basis and **Save** those changes before moving onto the next list.

- ie:     change the blacklist actions, then Save
- change the whitelist actions, then Save
- change the grey list actions, then Save

### 7.13.1 Audio - File Triggering

The camera can play an audio out via its 3.5mm audio socket, each time a number plate is recognised.

If a number plate is still in view this will cause the action to trigger again after a cool down period of 10 seconds.

This means any message uploaded to the the RoboPlate camera will play again after 10 seconds of initially being triggered.

If the message is required to not play again even if the number plate is still in the region of interest, then extend the actual audio file to a required period of time.

This can be edited and exported via an audio sound editing software, for example - *Audacity*<sup>®</sup>. Then make a custom file with blank audio after it to simulate a cool down period after the audio message. (If other actions are set, for example; an alarm output, this will still trigger again after 10 seconds if the number plate is still in the region of interest).

Note - The audio file format required is PCM 8Kbps MONO.



## 7.14 ANPR - Realtime Detection & Search

Navigate to: *Configuration > Smart Video > ANPR > Realtime Detection*

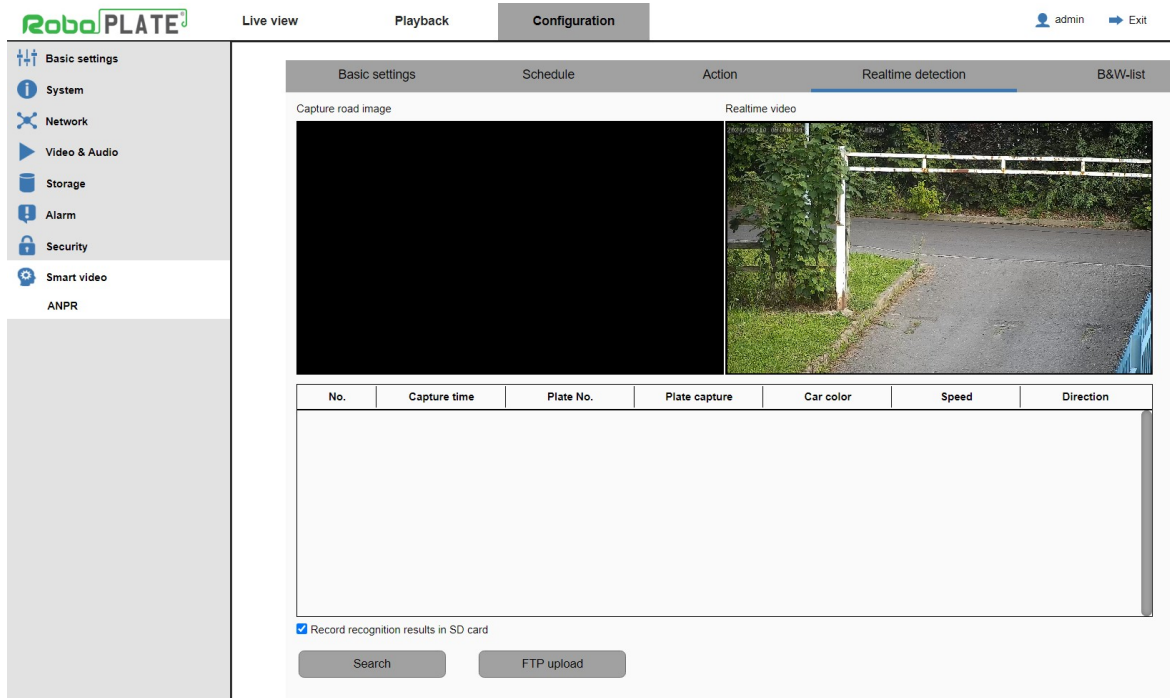

Realtime Detection shows a snapshot of the last number plate captured and allows for a basic search tool for searching through previously captured number plates.

To search for number plates click - Search, this displays the search tool for the ANPR database built into the camera.

For easier database searching and management, consider exporting the files (.CSV) to view in a 3rd party software or use the [ANPR Command Centre \(SOFT1045\)](#)<sup>2</sup>.

Field Name	Description
Capture Road Image	Shows the previous captured number plate as a still snapshot.
Realtime video	Shows a realtime stream of the video.
Search	Click to enter the tool for searching through the database of number plates captured.
FTP Upload	FTP upload the .CSV file to a selected FTP server . Setup the FTP settings in order to upload, see <a href="#">Storage (FTP)</a> <sup>28</sup> .



## 7.15 ANPR - B&W List

The camera supports a black and white list of up to 200 vehicle records.

Navigate to: *Configuration > Smart Video > ANPR > B&W List*

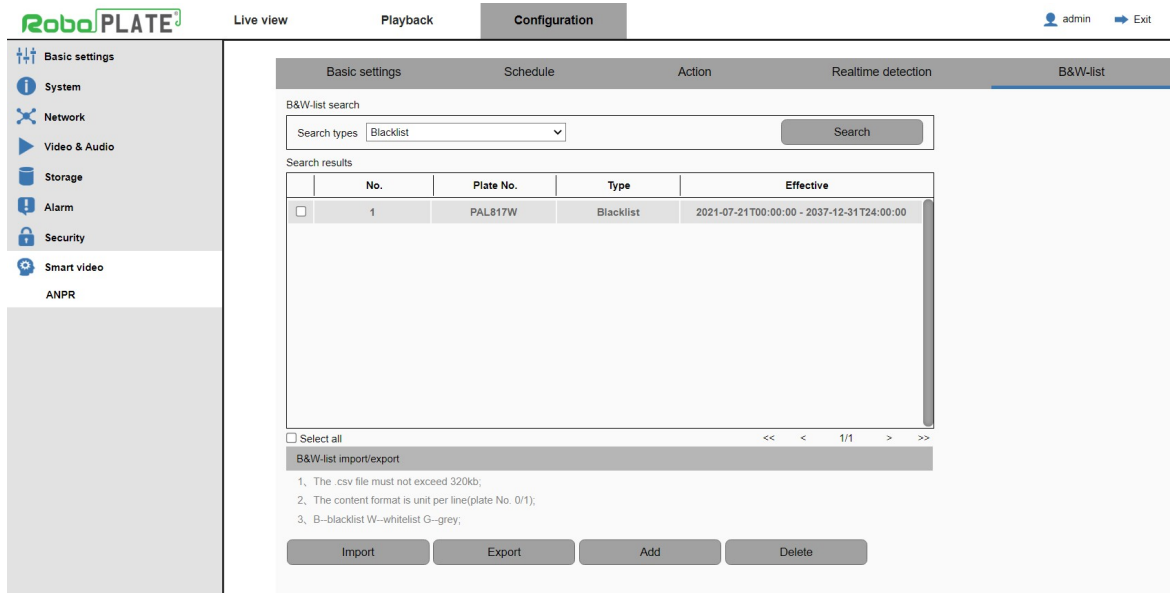

Vehicle records can be:

- Added manually via this web interface
- Imported via .csv
- Uploaded via the RoboPlate software

### Manually Adding Vehicle Records

Add black and white list ✕

Plate No.	<input type="text"/>	Type	<input type="text" value="Blacklist"/>
Effective date	<input type="text" value="2021-08-10"/>	Effective time	<input type="text" value="00 : 00 : 00"/>
Expire date	<input type="text" value="2021-08-10"/>	Expiration time	<input type="text" value="24 : 00 : 00"/>

Vehicle Field Name	Description
Plate No	The actual registration plate of the vehicle. <i>Note: Do not include spaces</i>
Type	Select black or white list membership
Effective date and time	The start date and time with regards to actions
Expiry date and time	The expiry date and time with regards to actions. Maximum expiry date = 31/12/2037





Click **Confirm** after making /any changes

### Importing Vehicle Records via .CSV

The camera expects a comma separated .csv file with the following format:

- Plate
- List indicator B or W
- Start date yyyy-mm-dd
- Start time : hh:mm:ss
- Expiry date: yyyy-mm-dd
- Expiry time: hh:mm:ss

Example:

```
PAL817W,B,2021-07-21,00:00:00,2037-12-31,24:00:00
```

Notes:

1. Fields should not be wrapped in double quotes
2. There should be no spaces in any field
3. Records should end with a CRLF
4. There should be no blank lines in the data.

### Upload Vehicle Records via RoboPlate ANPR Command Centre

Please refer to the *RoboPlate ANPR Command Centre* guide for information relating to vehicle record maintenance and upload to the camera.



## 7.16 I/O Alarm

### \*\*\* IMPORTANT \*\*\*

The alarm output of the camera is a 3.3V TTL output relay, this means the alarm output with either be in a low state (0V) or high state (3.3V).

Ensure an appropriate OPTO isolator relay is used to isolate the camera voltage to the triggering device.

For example the HRM100 - Handy Rascal OPTO Isolating Relay

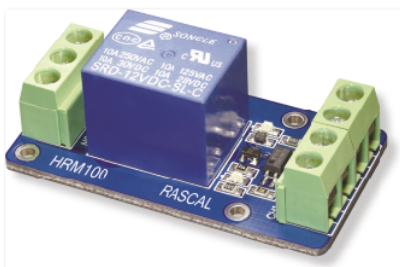

<https://systemq.com/store/Item/GP-HRM100>

Navigate to: *Configuration > Alarm > I/O alarm*

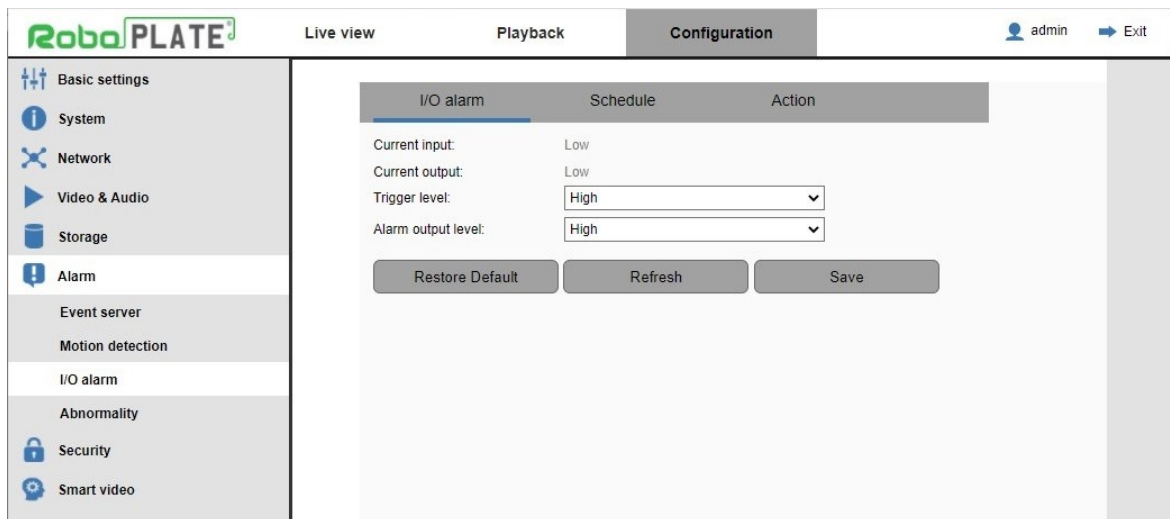

The alarm output of the camera can be configured either low state (0V) or high state (3.3V) when triggered.

When set to high, the alarm output will constantly be on low (0V) until the alarm output is triggered, it will then increase the voltage to high (3.3V) until the trigger is removed. The opposite will be configured when set to low.

For the wiring setup below, set the camera to Alarm output level = **High**

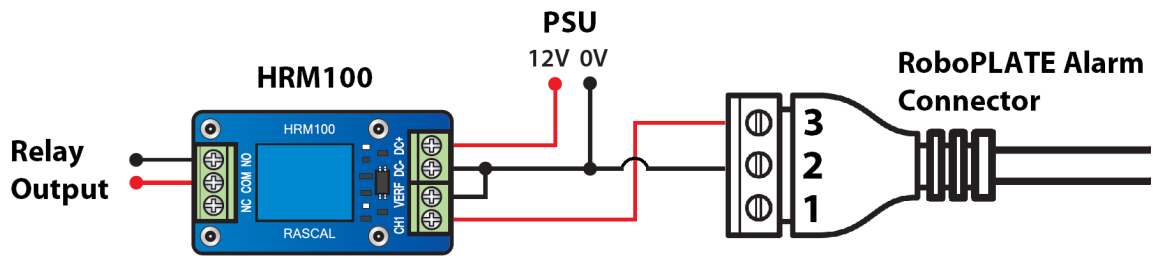

## Tip - Adding to a ZIP NVR / DVR on a LAN

1. In the menu of the Recorder, go to **Video > Video > IP Channels**

No.	Edit	IP Address/Domain	Port	Manufacturer	Device Type	MAC Address	Software Version
PoE IP Cam1	Auto Mode	Auto					
PoE IP Cam2	Auto Mode	Auto					
PoE IP Cam3	Auto Mode	Auto					
PoE IP Cam4	Auto Mode	Auto					
PoE IP Cam5	Auto Mode	Auto					
PoE IP Cam6	Auto Mode	Auto					

Auto Assign IP to Camera(s) Delete Camera Default Password

Total Band Width: 128Mbps, Used Band Width: 0bps



### 2. Set Switch Mode to **Manual**. (Ignore this step if using a non-PoE NVR or DVR)

<input type="checkbox"/>	No.	Edit	IP Address/Domain	Port	Manufacturer	Device Type	MAC Address	Software Version					
<input type="text" value="Search"/> <input type="button" value="Add"/> <input type="button" value="Add All"/>													
<input type="checkbox"/>	Camera	Switch Mode	PoE Mode	Edit	State	IP Address/Domain	Subnet Mask	Port	Manufacturer	Device Type	Protocol	MAC Address	Software Version
PoE	IP Cam1	Auto Mode	Auto Mode										
PoE	IP Cam2	Auto Mode	Manual Mode										
PoE	IP Cam3	Auto Mode	Auto										
PoE	IP Cam4	Auto Mode	Auto										
PoE	IP Cam5	Auto Mode	Auto										
PoE	IP Cam6	Auto Mode	Auto										

### 3. Then click **Search**

<input type="checkbox"/>	No.	Edit	IP Address/Domain	Port	Manufacturer	Device Type	MAC Address	Software Version					
<input type="button" value="Search"/> <input type="button" value="Add"/> <input type="button" value="Add All"/>													
<input type="checkbox"/>	Camera	Switch Mode	PoE Mode	Edit	State	IP Address/Domain	Subnet Mask	Port	Manufacturer	Device Type	Protocol	MAC Address	Software Version
	IP Cam1	Manual Mode	Auto										
	IP Cam2	Manual Mode	Auto										
	IP Cam3	Manual Mode	Auto										
	IP Cam4	Manual Mode	Auto										
	IP Cam5	Manual Mode	Auto										
	IP Cam6	Manual Mode	Auto										



4. Tick the camera in the search, then select Add.

<input checked="" type="checkbox"/>	o	Edit	IP Address/Domain ^	Port	Manufacturer	Device Type	MAC Address	Software Version
<input checked="" type="checkbox"/>	1		192.168.0.200	80		IP CAMERA		

Search **Add** Add All

<input type="checkbox"/>	Camera	Switch Mode v	PoE Mode v		Edit	State	IP Address/Domain	Subnet Mask	Port	Manufacturer	Device Type	Protocol	MAC Address	Software Version
	IP Cam1	Manual Mode	Auto	+										
	IP Cam2	Manual Mode	Auto	+										
	IP Cam3	Manual Mode	Auto	+										
	IP Cam4	Manual Mode	Auto	+										
	IP Cam5	Manual Mode	Auto	+										
	IP Cam6	Manual Mode	Auto	+										

Auto Assign IP to Camera(s) Delete Camera Default Password

Total Band Width: 128Mbps, Used Band Width: 0bps

5. Enter the port as **80**  
 Select the Protocol as **Onvif\_standard**  
 Enter the username and password of the camera.

Select **OK**

IP Address/Domain: 192.168.0.200

Camera Name: IP Cam1

Port: 80

Protocol: Onvif\_standard v

Username: admin

Password: ●●●●●● |  Show Password

Bind channel: IP Cam1 v

Search Default Password Add Cancel



6. The camera should appear with the IP Address in the bottom table with a green Camera symbol after a few seconds

Search Add Add All

<input type="checkbox"/>	Camera	Switch Mode ▾	PoE Mode ▾		Edit	Start	IP Address/Domain	Subnet Mask	Port	M
<input type="checkbox"/>	IP Cam1	Manual Mode	Auto				192.168.0.200	255.255.255.0	80	
	IP Cam2	Manual Mode	Auto							
	IP Cam3	Manual Mode	Auto							
	IP Cam4	Manual Mode	Auto							
	IP Cam5	Manual Mode	Auto							
	IP Cam6	Manual Mode	Auto							

Auto Assign IP to Camera(s) Delete Camera Default Password

## Frequently Asked Questions

### 9.1 Does it capture in rain, fog or snow?

Anything that prevents a clear view of a vehicle registration plate will hinder the program's ability to obtain a successful result. This includes rain, fog, snow and other obstructions.

### 9.2 Can non-standard characters be recognised?

The camera does not look for or match to specific fonts. We expect characters to be regular upright shapes rather than fancy/italic style.

### 9.3 Why do I get unexpected results?

Many factors affect recognition : partially obscured or background objects within an image can appear to be legitimate characters detectable, anything that appears to be a character or impacts on a character or it's outline can produce a result.

Some owners of 'private plates' in the UK re-position mounting screws or deliberately change a character's shape to make their plate more desirable, in doing so, they make recognition harder.

### 9.4 What speed can vehicles travel?

The camera frame rate and shutter speed a major determining factor on the speed of the car and if the camera can detect a number plate.

This can be adjusted in the camera settings to suit, however as default it is intended for slow moving traffic that stays in the field of view for a reasonable amount of time to achieve this.

### 9.5 Where do I get support?

Customers buying via a reseller should contact that reseller/supplier in the first instance. All resellers have agreed to provide end user customer support as part of their contract with us.

For customers buying online, free email support is available via a ticketing system at [softcctv.com](mailto:softcctv.com) ... please quote your software key in any request you create, without this, support cannot be provided.



## Specification

### 10.1 ROBOPCZ22

Image Sensor	1/2.8 Progressive CMOS
Resolution	2MP (1920x1080)
Lens Type	5mm – 50mm Motorised Lens
Shutter	1/2 ~ 1/50000s
Day/Night	Mechanical (True Day-Night)
Video Compression	H.264 / H.265
Alarm	3.3V TTL Output (Terminal)
Audio In	Mic (Built-In)
Audio Out	1 Output (3.5mm Audio Socket)
RS485	1 Output (Terminal)
Connection	RJ45 10M / 100M Ethernet PoE
Protocols	TCP/IP, HTTP, DHCP, DNS, RTSP, SMTP, NTP, UpnP, FTP
User Logins	Max 5 Simultaneous User Logins
Backlight Control	BLC / D-WDR / HLC
Use	IP66 For External Use
Input Voltage	PoE (48V) / 12V DC
Consumption	500mA (with IRs on)
System Compatibility	ONVIF Protocol
Dimensions	Ø 120mm x H 110mm





## 10.2 ROBOPMZ50

Image Sensor	1/2.8 Progressive CMOS
Resolution	2MP (1920x1080)
Lens Type	5mm – 50mm Motorised Lens
Shutter	1/2 ~ 1/50000s
Day/Night	Mechanical (True Day-Night)
Video Compression	H.264 / H.265
Alarm	3.3V TTL Output (Terminal)
Audio Out	1 Output (3.5mm Audio Socket)
RS485	1 Output (Terminal)
Connection	RJ45 10M / 100M Ethernet PoE
Protocols	TCP/IP, HTTP, DHCP, DNS, RTSP, SMTP, NTP, UpnP, FTP
User Logins	Max 5 Simultaneous User Logins
Backlight Control	BLC / D-WDR / HLC
Use	IP66 For External Use
Input Voltage	PoE (48V) / 12V DC
Consumption	500mA (with IRs on)
System Compatibility	ONVIF Protocol
Dimensions	L 288mm x W 98mm x H 83mm





# Index

## - A -

- Adding vehicle records 37
- Additional Software and Modules 2
- Alarm input and output setting 39
- Angle for best performance 9
- Angle of view 9
- ANPR Command Centre Software 2
- ANPR Database 36
- Area of Interest 30
- Assigning an IP address 11
- Attaching and Mounting the Camera 5

## - B -

- Basic ANPR settings 30
- Black and whitelist 37
- Browser ports 27

## - C -

- Camera Configuration 18
- Capturing with rain, fog or snow 44
- Configuring using WildKat 19
- Connecting direct to a PC 7
- Connecting to a Non-POE Switch 7
- Connecting to a POE switch 7
- Connections and terminals 5
- Corrupt SD card files 11

## - D -

- Date and time setting 24
- Daylight saving time 24
- Device Activation 22
- Download WildKat Manager 18

## - E -

- Essential Tools 1

## - F -

- Field of View 30
- Field of View and Lens Positioning 9

- Finding an available IP address 11
- Finding an IP address to use 11
- Finding the PC's IP address 11
- FTP storage settings 28

## - I -

- Identifying the network adaptor 11
- Importing vehicle records 37

## - K -

- Key Features 1

## - L -

- Lighting and Infra-Red LEDs 9

## - N -

- Network TCP / IP 26
- Non-standard characters 44
- NTP server 24

## - O -

- Options for connecting the Camera 7
- OPTO isolator relay 39

## - P -

- Port settings 27
- Positioning the camera 9
- Powering the camera 5
- Protocol setting 27

## - R -

- Realtime Detection 36
- RegWATCH Software 4
- Requesting support 44
- RoboPlate FTP Server Software 3

## - S -

- Schedule ANPR CSV data 31
- SD card information 11
- Setting ANPR alarm action 33

**xROBOPCZ22 & xROBOPMZ50**

Setting ANPR capture schedule	31
Setting the Camera Number	23
Setting the Device Name	23
Setting the IP address	19
Setting the zoom	9, 25

**- T -**

Traffic speed	44
---------------	----

**- U -**

Unexpected ANPR results	44
-------------------------	----

**- W -**

Wildkat Manager Software	1
--------------------------	---