



Instruction Manual

SEE895

Table of Contents

Part 1 Introduction	1
1 SEE895	1
Part 2 Tools & Handy Extras	1
Part 3 Connections & Dipswitches	2
Part 4 Dipswitch 4-In-1 Technology	2
Part 5 Mounting	3
1 Eyeball	3
Part 6 Motorised Lens	4
Part 7 OSD Menu	5
1 5MP OSD Menu Motorised	6
2 Key Menu Settings	8
Part 8 Troubleshooting	9
1 Camera Rebooting / Turning Off	9
2 Poor Quality Images	9
3 Image is Black & White	9
4 NCD / No Image Displayed on Recorder	9
Part 9 General Maintenance	10
Part 10 Specification	11
1 SEE895	11
Part 11 Conditions	12
1 General Company Disclaimer	12
2 WEEE Declaration	12
3 Copyright	12
Index	13

Introduction

1.1 SEE895

The SEE895 has a motorised lens so that you can set the zoom and focus from the DVR. With 4-in-1 technology design means you can set the output signal to either TVI, CVI, AHD or CVBS.

Built in twin IR arrays provide 40m of night time vision to get 24/7 performance on these new eyeballs.

This 5MP model is a perfect match for higher spec DVRs such as the new Zip Supa DVR that can record in 5MP quality. Pick this model for finer detailing if your business relies on its CCTV to protect employees or stock.

Tools & Handy Extras

- Screwdriver
- Drill
- 12V DC PSU
- Drill bits
- BNC Crimp Tool & BNCs
- RG59 Coax Cable
- Digital Multi-Meter
- LCD400K - CCTV Test monitor

Connections & Dipswitches

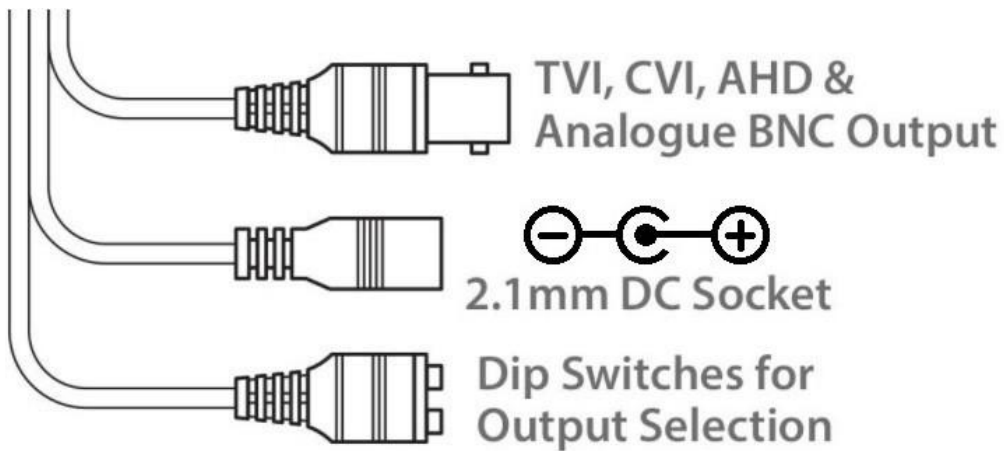

The camera has a 2.1mm socket which requires 12V DC, use a regulated power supply rated above the current draw of the camera.

The camera is polarity sensitive so connections must be correctly made.

The camera has a standard BNC connector for the 4-in-1 video output, the output can be changed to AHD, CVI or CVBS if required.

Dipswitch 4-In-1 Technology

Selectable HD-TVI, HD-CVI, AHD and CVBS (Analogue) Output. As default the camera is set to HD-TVI, however the output can be changed to AHD, CVI or CVBS if required.

This output can be changed with the dip switches on the fly-lead of the camera. Please note the “Output Mode” in the menu of the DVR won’t change the format, as the dip switch overrides the output.

The dip switch configuration can be found below:-

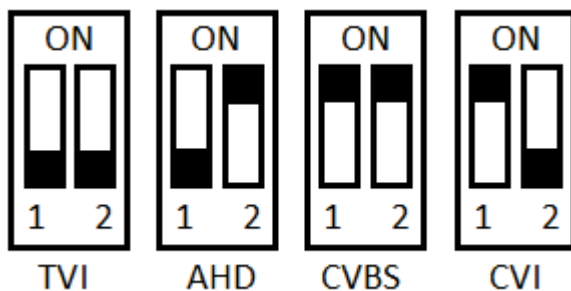

Mounting

5.1 Eyeball

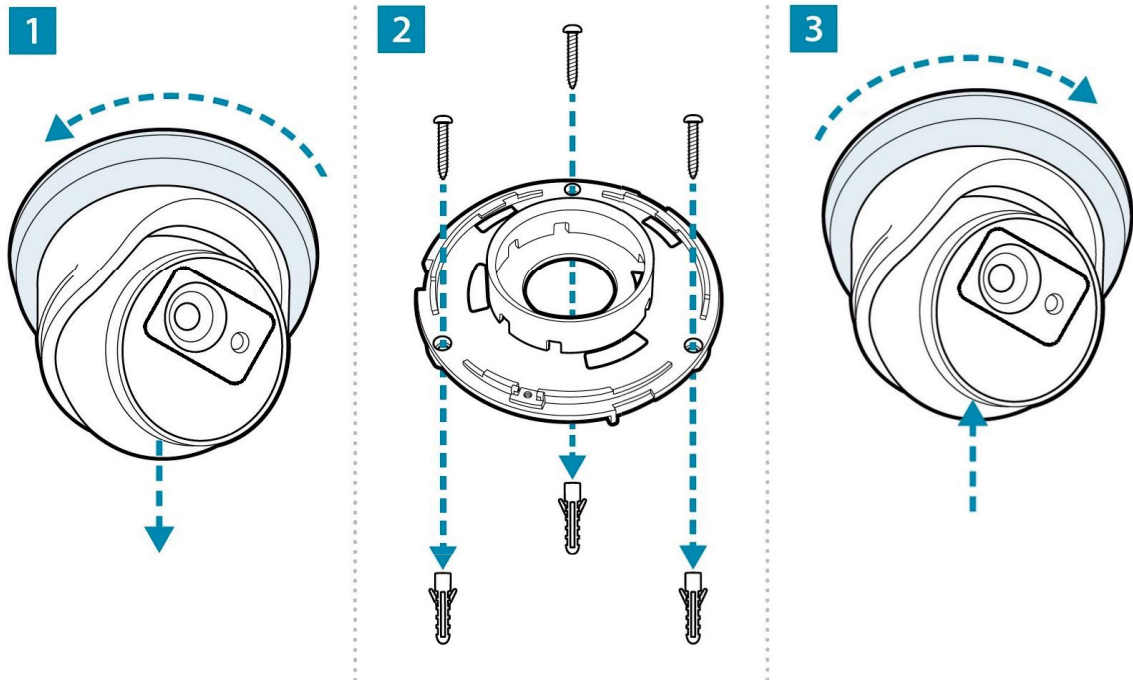

A template is provided in the box for marking the hole positions for the fixing screws.

Motorised Lens

To access the Motorised Lens via coaxitron:-



1. Click on the image in Live view
2. Click on the PTZ button at the bottom of the screen
3. Use Zoom + and - to zoom in and out, the camera should automatically focus when Zoom +/- is released

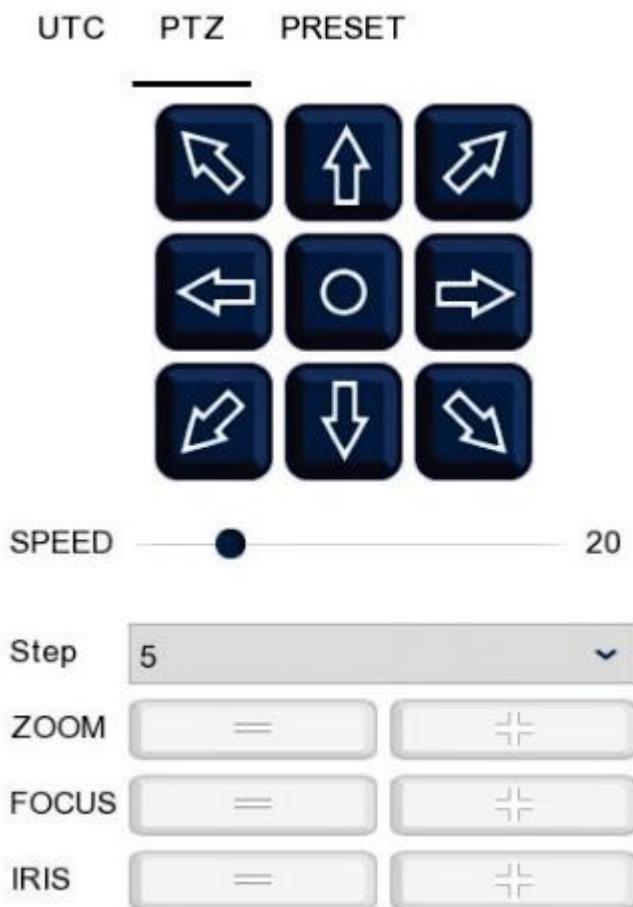

OSD Menu

Access to the camera menu is by Coaxitron. *For the ZIP DVRs, ZIP Coaxitron is set as default.*

To access the Cameras Menu via coaxitron:-



1. Click on the image in Live view
2. Click on the PTZ button at the bottom of the screen
3. Click on the IRIS + / centre button to display the menu

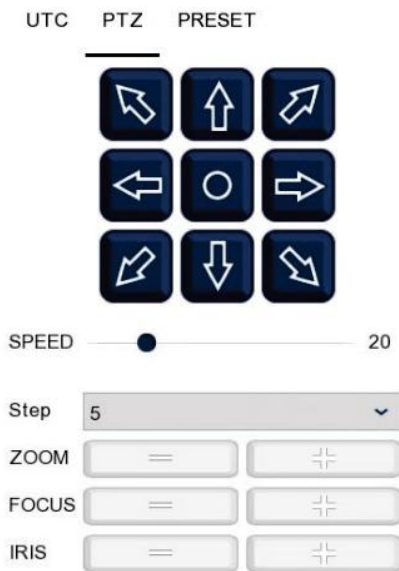

Use the directional arrows to move up and down through the menu.

Use the directional arrows left and right to change the option.

Use IRIS + to select & enter that menu option.

7.1 5MP OSD Menu Motorised

AE	BRIGHTNESS	0 ~ 100 (Default 34)
	EXPOSURE MODE	GLOBAL /
		BLC 0 ~ 7 (Default 4)
	RETURN	
AF	AF MODE	SEMI / AUTO / MANUAL
	ZOOM	- / +
	FOCUS	- / +
	BOOT MODE	SAVE POS / WIDE END / TELE END /
	TDN AD	OPEN / CLOSE
	FOCUS TRIGGER	SELECT (IRIS +)
	LENS INIT	SELECT (IRIS +)
	RETURN	
AWB	MODE	PRO / GREY WORLD
	RGAIN	0 ~ 100 (Default 50)
	BGAIN	0 ~ 100 (Default 50)
DAY / NIGHT	MODE	EXT / COLOR / B/W
	RETURN	
IMAGE ENHANCE	CONTRAST	AUTO /
		MANUAL
		0 ~ 20 (Default 5)
	SHARPNESS	AUTO /
		MANUAL
		0 ~ 20 (Default 3)
	SATURATE	AUTO /
		MANUAL
		0 ~ 20 (Default 10)
	3DNR	AUTO /
		MANUAL
		0 ~ 20 (Default 13)

	2DNR	AUTO / MANUAL 0 ~ 20 (Default 19)	
	RETURN		
VIDEO SETTING	HD	NO ADJUSTMENT SEE 4-IN-1 SWITCH	
	STANDARD	5MP 20 / 4MP 25 / 4MP 30 / 1080P 25 / 1080P 30 /	
	REBOOT & APPLY		
	RETURN		
LANGUAGE	ENGLISH / SIMPLIFIED CHINESE / TRADITIONAL CHINESE / RUSSIAN / SPANISH / FRENCH / POLISH / ITALIAN / PORTUGUESE		
WDR	OFF / ON		
FUNC	PRIVACY	MODE	OFF / ON
		AREA 0	CUSTOMISE
		AREA 1	CUSTOMISE
		AREA 2	CUSTOMISE
		AREA 3	CUSTOMISE
		COLOR	RED / GREEN / BLUE
		TRANSPARENCY	OFF / ON
		RETURN	
	RETURN		
RESET			
SAVE – EXIT			
EXIT			

7.2 Key Menu Settings

Exposure Mode - AUTO / GLOBE / GLOBAL sets the required shutter speed for the current light level. The shutter speed will automatically detect the required length of time to keep the digital sensor exposed to light. FLK option sets the shutter speed to stop synchronisation with lighting so that pulsing effect is minimised.

White Balance - Colour adjustment of the camera to be set up so objects appear a natural colour. ATW / PRO (Automatic tracking white balance) continually tracks and adjusts the white balance, making it suitable for use in cameras in which the image content and lighting are subject to changes.

Day & Night - The camera can be set to colour or B&W mode or have it automatically switch. External is set as default, the switch between colour and black & white is controlled by an external trigger. In this a light dependent resistor.

DNR (Noise Reduction) - Noise Reduction is the process of removing noise from the video signal by applying a digital filter. 2D noise reduction reduces noise in the foreground of the image where as 3D noise reduction reduces noise in both the foreground and the background of the image.

D-WDR - Digitally adjusts the exposure in areas of the frame to maintain optimum levels in both the dark and bright areas of an image.

NOTE - Some models may not have D-WDR function.

Reset - Defaults the camera to factory settings. This setting helps when fault finding issues with the camera to ensure all settings are defaulted.

Troubleshooting

8.1 Camera Rebooting / Turning Off

- A. Check the voltage to the camera (under load) using a digital multi-meter, if below 10.8V then move the power supply closer to the camera.
- B. For 12V DC cameras, only use regulated power supply rated above the current consumption, so that the camera is always receiving the correct supply which is rated above the current consumption.
- C. Use thicker gauge copper cabling to reduce the voltage drop to the camera, using thicker cable will reduce the resistance between the camera and the power supply and therefore reduce the voltage dropped along the cable.

8.2 Poor Quality Images

- A. Check the video format the DVR (digital video recorder), then set the camera to the relevant video format – see the 4-In-1 Technology
- B. If set to CVBS, then this is a low quality video output for legacy systems (analogue - CVBS), when using a 2 MegaPixel DVR or above then use another video format, like HD-TVI.
- C. Reset the camera menu via Zip Coaxitron – [OSD Menu](#) 
- D. Check if the DVR (digital video recorder) supports the resolution of the camera.

8.3 Image is Black & White

- A. Check the video format your DVR supports, then set the camera to the relevant video format – see the 4-In-1 Technology
- B. Reset the camera menu via Zip Coaxitron [OSD Menu](#) 
- D. Check if the DVR (digital video recorder) supports the resolution of the camera.

8.4 NCD / No Image Displayed on Recorder

- A. Check the voltage to the camera (under load) using a digital multi-meter, if below 10.8V then move the power supply closer to the camera.
- B. For 12V DC cameras, only use regulated power supply rated above the current consumption, so that the camera is always receiving the correct supply which is rated above the current consumption.

C. Use thicker gauge copper cabling to reduce the voltage drop to the camera, using thicker cable will reduce the resistance between the camera and the power supply and therefore reduce the voltage dropped along the cable.

D. Ensure that the BNC – BNC lead that is connected between the camera and DVR has no shorts between the ground and the centre core (positive) or open circuits along the centre core (positive) or open circuits along the ground.

General Maintenance

- Routinely clean the camera to prevent dust build up as this can effect the performance of the camera. It is recommended to use a damp non-abrasive microfibre cloth.
- Routinely check the connections for power and data to ensure no water ingress and corrosion.
- Check that the cameras are firmly attached to the wall or mounting bracket.
- Check playback in the recorder to ensure the camera is recording and triggering properly.

Specification

10.1 SEE895

Resolution	5MP
Lens Type	2.8-12mm Motorised
Image Output	1 Volt Peak-Peak 75 ohm
Min. Illumination	0 Lux IR On
Day/Night	Mechanical (True Day-Night)
IR Range	40m
Input Voltage	12V DC
Current Consumption	500mA (IR On)
IP Rating	IP66
Video Connection	BNC Socket
Power Connection	2.1mm DC Socket
WDR	Yes
Finish	White/ Grey
Build	Metal
Dimensions	135mm (Diameter) x127mm (Height)

Conditions

11.1 General Company Disclaimer

All specifications are approximate. System Q Ltd reserves the right to change any product specifications or features without notice. Whilst every effort is made to ensure that these instructions are complete and accurate, System Q Ltd cannot be held responsible in any way for any losses, no matter how they arise, from errors or omissions in these instructions, or the performance or non-performance of the equipment that these instructions refer to.

11.2 WEEE Declaration



This symbol on the products and/or accompanying documents means that used electronic equipment must not be mixed with general household waste. For treatment, recovery and recycling please return this unit to your trade supplier or local designated WEE/CG0783SS collection point as defined by your local council.

11.3 Copyright

© Copyright 2022

Zip is a registered trademark of System Q Ltd, Chesterfield. Derbyshire. S40 2WB

Index

- 2 -

2.1mm DC Socket 2

- 4 -

4-In-1 Technology 2

- A -

Adjustment 5
AHD 2

- B -

BNC 2

- C -

Cleaning 10
Connections 2, 10
Copyright 12
CVBS 2
CVI 2

- D -

Declaration 12
Dimensions 11
Dip-Switches 2
Disclaimer 12

- F -

Format 2

- G -

General Disclaimer 12

- H -

Handy Extras 1

- M -

Maintenance 10
Motorised Lens 4
Mounting 3

- O -

OSD Menu 5
Output 2

- P -

Power 2

- S -

Settings 5
Specification 11

- T -

Tools 1
Troubleshooting 9
TVI 2

- V -

Video 2
Video Loss 9
Voltage drop 9

- W -

WEEE Declaration 12