



• Professional Door Entry Systems •

# Introduction

The DoorKnox range of high spec video door entry equipment can be combined to create a comprehensive door entry system for any environment. From a small residential project with a single camera and a modest 4" monitor to multiple cameras with key code and key fob entry displayed on multiple 10.1" monitors for a large commercial site.

Each external door camera has its own distinctive style to suit the taste of the customer and the environment it is being installed into. They all feature a high resolution 800TVL camera, two way audio and IR LEDs so you can still see who's calling on the darkest of nights.

Our touch button monitors provide you with full control of your door entry system and are available in a choice of three sizes; 4", 7" and 10.1". Two door cameras and two door locks can be connected to the monitor as well as two analogue CCTV cameras with alarms for intruder detection.

For added security and peace of mind all of our monitors have a clever feature which captures a snapshot whenever the door camera is pressed and saves it into the built in internal storage. The storage capacity can be extended with the 32GB memory card supplied with the monitor. There's also video output for connecting to a DVR for a fully integrated security system.

With the feature packed DoorKnox range you can create a complete, versatile video door entry solution which out performs any other.



# Contents



<b>VDP101</b>	<i>Specification</i>	<b>04</b>
	<i>Features &amp; Connections</i>	<b>04</b>
	<i>Mounting</i>	<b>05</b>
<b>VDP102</b>	<i>Specification</i>	<b>06</b>
	<i>Features &amp; Connections</i>	<b>06</b>
	<i>Mounting</i>	<b>07</b>
<b>VDP103</b>	<i>Specification</i>	<b>08</b>
	<i>Features &amp; Connections</i>	<b>08</b>
	<i>Mounting</i>	<b>09</b>
	<i>Programming &amp; Using</i>	<b>10</b>
<b>Monitors</b>	<i>Specifications</i>	<b>12</b>
	<i>Features</i>	<b>13</b>
	<i>Connections</i>	<b>16</b>
	<i>Mounting</i>	<b>16</b>
<b>Wiring A System</b>		<b>17</b>
<b>Using The Menu System</b>		<b>21</b>
<b>Using Your Door Entry System</b>		<b>30</b>
<b>Fault Finding</b>		<b>32</b>
<b>Other Products To Consider</b>		<b>33</b>

# VDP101 - External Door Entry Camera



The stone effect and classic design of the VDP101 makes it a firm favourite for installs on more traditional properties.

The camera is supplied with an optional sun/rain shield and angled bracket to help you capture the best possible images.

There's also a matching recessed mount bracket available for a smarter looking finish. **Order code VDP101-BASE.**

Image Sensor	1/3" CMOS
Resolution	800TVL
Lens Type	3.7mm Pinhole / 68° Viewing Angle
Power	12V DC / ≤200mA
Build	Rust-proof aluminium alloy
Dimensions	(H) 123.5 x (W) 44.5 x (D) 50mm (Including Shield)

## Features & Connections

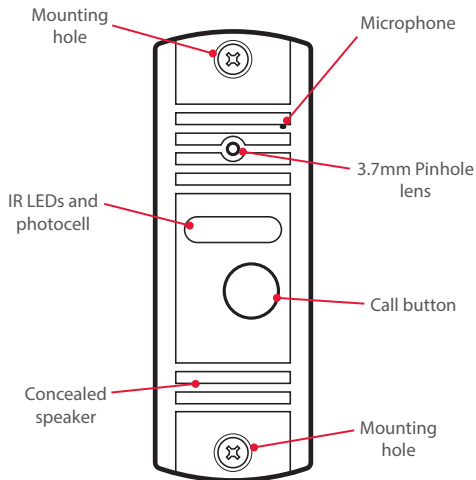

# VDP101 - External Door Entry Camera

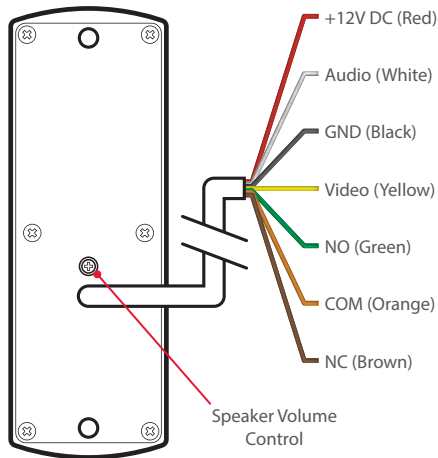

For more information on wiring a system see pages 16-20.

## Mounting

When mounting the door entry camera we recommend that it is installed between 150 to 160cm above the floor (About 5 feet) and where it will not be in direct sunlight.



### Surface Mounting

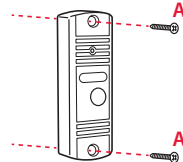

### Angle Mounting

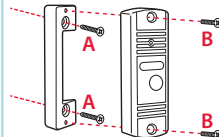

### Recessed Mounting

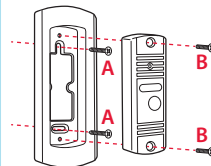

# VDP102 - External Wide Angle Door Entry Camera



With its sleek and contemporary design the VDP102 looks great on modern residential, retail and commercial installs.

The wide angle 2.4mm lens allows you to see more giving you a better idea as to who's calling.

The VDP102 features a built-in sun/rain shield and is supplied with an optional angled bracket so that you can attain the perfect image.

Image Sensor	1/3" CMOS
Resolution	800TVL
Lens Type	2.4mm Wide Angle Pinhole / 110° Viewing Angle
Power	12V DC / ≤200mA
Build	Rust-proof aluminium alloy
Dimensions	(H) 128 x (W) 49 x (D) 41mm

## Features & Connections

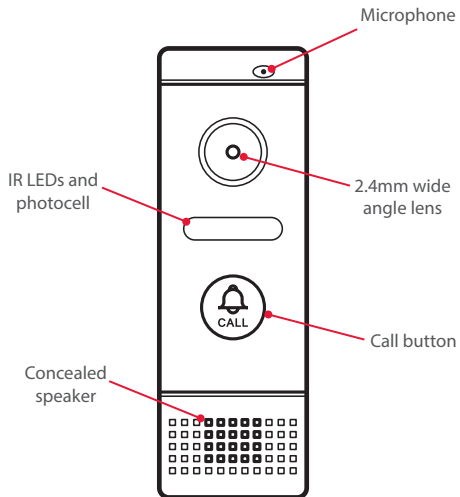

# VDP102 - External Wide Angle Door Entry Camera

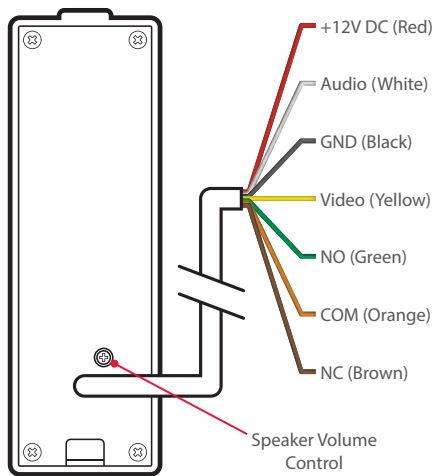

For more information on wiring a system see pages 16-20.

## Mounting

When mounting the door entry camera we recommend that it is installed between 150 to 160cm above the floor (About 5 feet) and where it will not be in direct sunlight.

### Surface Mounting

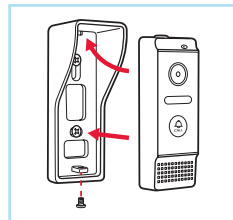
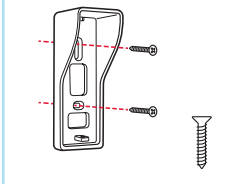

### Angle Mounting

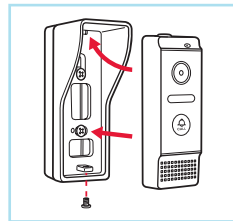
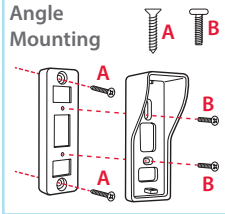

# VDP103 - Door Entry Camera With Secure Access



With a stylish brushed aluminium finish and quality build the VDP103 is ideal for retail and commercial projects.

As well as functioning as a standard door entry camera, trusted users can also activate the door release and enter the building using the VDP103 with either a programmable key code or key fob (2 key fobs supplied, additional key fobs available. **Order Code VDP103-FOB**).

Image Sensor	1/3" CMOS
Resolution	800TVL
Lens Type	3.6mm Board / 85° Viewing Angle
Power	12V DC / ≤300mA
Build	Rust-proof aluminium alloy
Dimensions	(H) 210 x (W) 105 x (D) 32mm

## Features & Connections

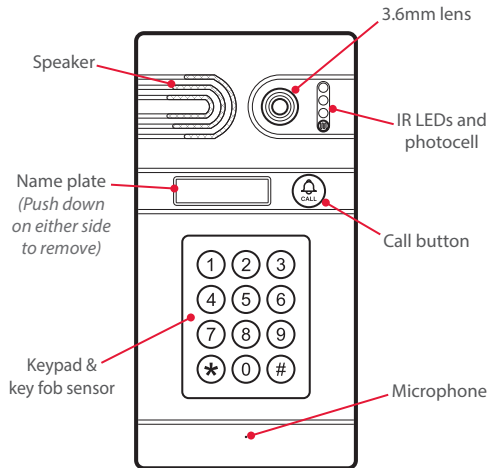



# VDP103 - Door Entry Camera With Secure Access

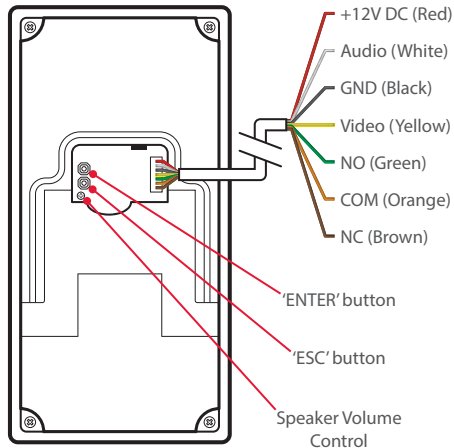

## Mounting

When mounting the door entry camera we recommend that it is installed between 150 to 160cm above the floor (About 5 feet) and where it will not be in direct sunlight.

If you choose to recess mount the camera you will need to create a recess of 200mm (h) x 96mm (w) x 29mm (d). It is important that the recess created is no more than 30mm deep as you will not be able to secure the camera.

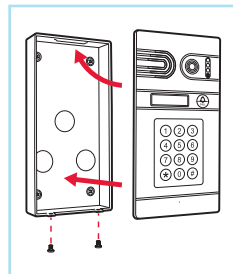
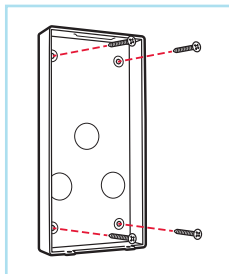

For more information on wiring a system see pages 16-20.

# VDP103 - Door Entry Camera With Secure Access

## Creating New Key Codes

Up to 40 key codes can be saved to each VDP103 door camera. Creating new key codes is easy as described in the steps below:

- 1 Press 'ENTER' on the rear of the camera and you will hear a beep.
- 2 Enter your new key code followed by the '#' key. You will hear a long beep confirming the new key code has been created.

**Note** Key codes must be between 4 and 8 characters long and can not include the '\*' or '#' key.

*If the maximum 8 characters are entered you will hear a long beep confirming the key code has been created so you don't need to press the '#' key.*

## Pairing Key Fobs

A maximum of 40 key fobs can be paired to a single VDP103. Each key fob however can be paired to multiple door cameras so the same key fob can be used to open multiple doors.

You will need to pair the key fob to each door entry unit separately. To pair a key fob to a VDP103 just follow the simple steps below:

- 1 Press 'ENTER' on the rear of the camera and you will hear a beep.
- 2 Swipe the key fob across the keypad. You will hear a long beep confirming the key fob had been paired successfully.



# VDP103 - Door Entry Camera With Secure Access

## Deleting Users

To improve security from time to time you may wish to change key codes and unpair key fobs.

To restore the VDP103 back to factory default deleting all users just follow the steps below:

- 1 Press and hold the 'ENTER' and 'ESC' buttons on the rear of the camera at the same time for 10 seconds.
- 2 After 10 seconds you will hear a long beep confirming all users have been erased. You can now follow the easy steps on the previous page to create new key codes and pair required key fobs.

## Using The VDP103 Door Camera

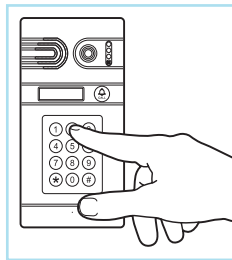

### Entering Key codes

To release an electronic door using a key code simply enter the key code followed by the '#' key (No need to press '#' for 8 digit key codes). You will hear a long beep if the key code is correct. If incorrect you will hear two short beeps.

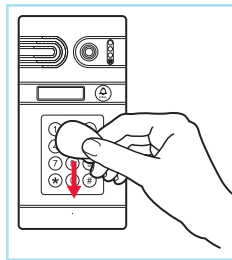

### Using A Key fob

To release an electronic door with a paired key fob just swipe the key fob across the keypad and you will hear a long beep. Two short beeps indicate the key fob is not paired with the door camera.

# Monitors - Specifications

Each of our quality touch button door monitors can be connected to two door cameras plus two auxiliary cameras. Up to four door monitors can be connected together and there's even a TV monitor output so your door entry system can be fully integrated into your CCTV system.



	VDP204	VDP207	VDP210
Screen Size	4"	7"	10.1"
Resolution	320 x 240	800 x 600	1024 x 600
Camera Inputs	2x Door Cameras / 2x Auxiliary Cameras	2x Door Cameras / 2x Auxiliary Cameras	2x Door Cameras / 2x Auxiliary Cameras
Door Monitor Inputs	1	1	1
Door Monitor Outputs	1 (3 Slaves Max)	1 (3 Slaves Max)	1 (3 Slaves Max)
TV Monitor Outputs	1 (720 x 576)	1 (720 x 576)	1 (720 x 576)
Memory Card Slot	Micro SD / 32GB Max / Class 10 Min (Supplied)	Micro SD / 32GB Max / Class 10 Min (Supplied)	SD / 32GB Max / Class 10 Min (Supplied)
Power / Consumption	12V DC / 300mA (1A PSU Supplied)	12V DC / 400mA (1A PSU Supplied)	12V DC / 500mA (1A PSU Supplied)
12V DC Output	400mA Max Across All Outputs	400mA Max Across All Outputs	400mA Max Across All Outputs
Build	Plastic (Brushed Aluminium Effect)	Brushed Aluminium & Plastic	Brushed Aluminium & Plastic
Dimensions	(H) 169 x (W) 119 x (D) 21mm	(H) 165 x (W) 245 x (D) 23mm	(H) 210 x (W) 334 x (D) 27mm

# Monitors - VDP204 Features

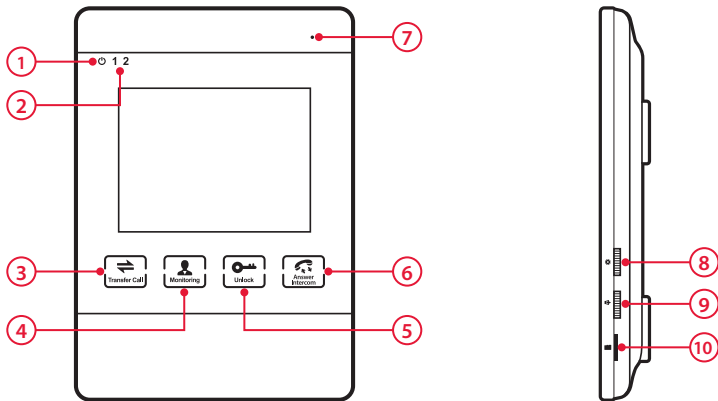

1	Power Indicator
2	Door camera indicator shows which camera is being displayed
3	Transfer - Send call to other monitor(s) / Intercom
4	Monitoring - Switch between camera inputs
5	Unlock - Unlock door connected to camera being displayed
6	Answer Intercom - Answer call / End call / Return in menu system

7	Microphone
8	Settings - Press to enter menu system / Flick up and down to navigate menu system / Press again to make selection
9	Volume control
10	Micro SD card slot

# Monitors - VDP207 Features

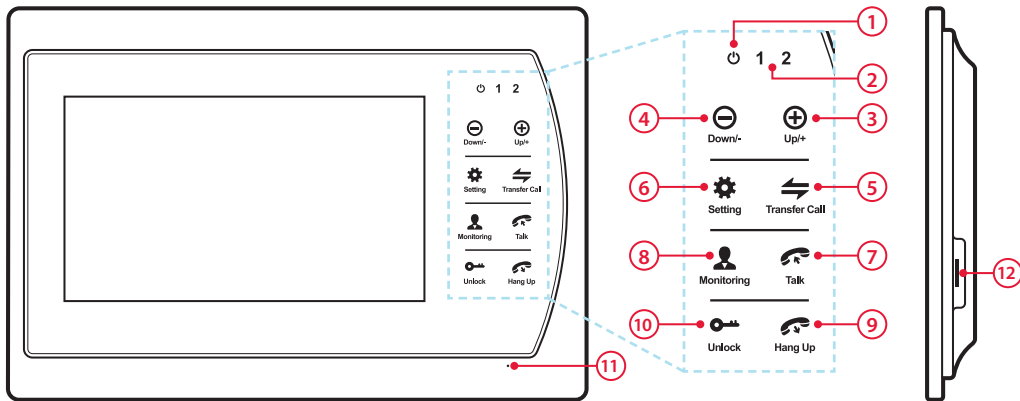

1	Power Indicator
2	Door camera indicator shows which camera is being displayed
3	Up - Volume up / Move up in menu system
4	Down - Volume down / Move down in menu system
5	Transfer - Send call to other monitor(s) / Intercom
6	Settings - Enter menu system / Press again to make selection

7	Talk - Answer call
8	Monitoring - Switch between camera inputs
9	Hang Up - End call / Return to previous screen / Cancel
10	Unlock - Unlock door connected to camera being displayed
11	Microphone
12	Micro SD card slot

# Monitors - VDP210 Features

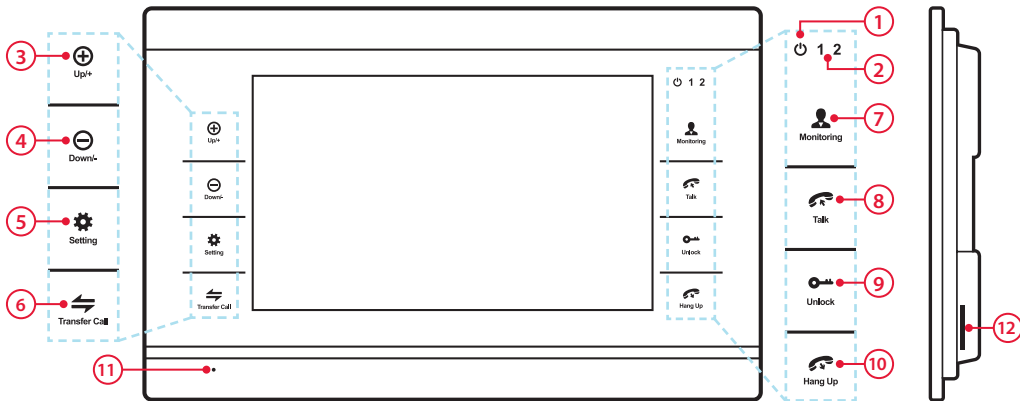

1	Power Indicator
2	Door camera indicator shows which camera is being displayed
3	Up - Volume up / Move up in menu system
4	Down - Volume down / Move down in menu system
5	Settings - Enter menu system / Press again to make selection
6	Transfer - Send call to other monitor(s) / Intercom

7	Monitoring - Switch between camera inputs
8	Talk - Answer call
9	Unlock - Unlock door connected to camera being displayed
10	Hang Up - End call / Return to previous screen / Cancel
11	Microphone
12	SD card slot

# Monitors - Mounting & Connections

## Mounting

The principles are the same for mounting each monitor. The mounting plate is secured to the mounting surface and then the monitor simply slots on to it. There is a large hole in the centre of the mounting plate to allow the cables to pass through.

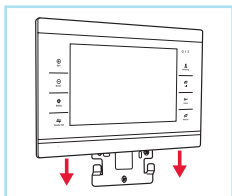
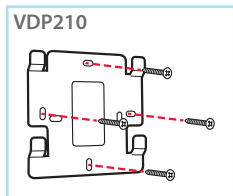
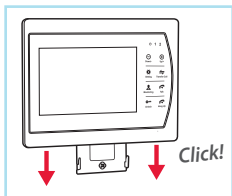
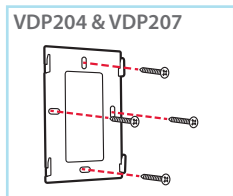

## Connections

To make life easier all three monitors feature the exact same connection layout as shown below.

### TV Out



### Power



### Door Cam 1



### Auxiliary Cam 1

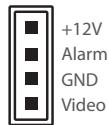

### Monitor In

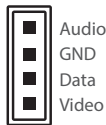

### Door Cam 2



### Auxiliary Cam 2

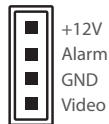

### Monitor Out





# Wiring A System - Connections

## Cameras

All of our door cameras have connection cables terminated into the same 7 colour coordinated wires. 4 wires are used to connect to the monitor and then 2 of the 3 remaining wires are used to connect to an electronic door lock. The common (COM) wire is always used along with either the normally open (NO) or normally closed (NC) wire depending on the lock type.

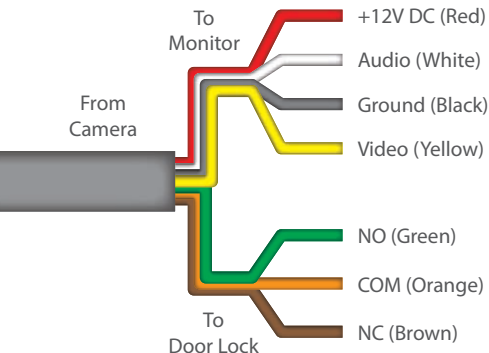

## Monitors

Every monitor is supplied with 5x 4 wire fly-leads and 1x 2 wire fly-lead.

The 4 wire fly-leads are terminated into 4 pin plugs which are simply inserted into the sockets on the rear of the monitor. These are used for connecting door cameras, auxiliary cameras and additional door monitors as shown on the previous page. To make installation easier the 4 wires are colour co-ordinated to match the 4 wires from the door camera.

The two wire fly-lead is terminated with a 2 pin plug and is used as the TV out for connecting the door monitor to a TV monitor or DVR.

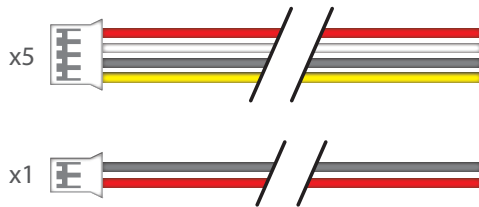

# Wiring A System - Powering & Cabling

## Powering Cameras

Door cameras and auxiliary cameras can be powered in two ways, either locally or via the door monitor.

The DoorKnox monitors can supply a 12V DC output to any of the four cameras but can only supply a maximum of 400mA across all outputs. To power a camera using a door monitor simply connect the wires as shown on the opposite page.

To power a camera locally only connect the Audio (white) and Video (Yellow) wires to the door monitor. The 12V DC (red) and Ground (black) wires from the camera can then be connected to a local power source.

## Powering Monitors

Door monitors are supplied with a 12V DC 1A plug-in PSU that terminates into a 2 pin plug which slots into the rear of the monitor. See page 16.



## Cable Runs

The maximum achievable cable run is limited by the voltage drop in the chosen cable. Resistance differs depending on the cable used and the higher the resistance the more dramatic the voltage drop.

We recommend that you use one of three types of cable, PTZ combo cable sometimes known as RG59+4, CAT5+2 cable or 4 core cable with 0.3mm<sup>2</sup> cores.

The table below shows the maximum recommended cable run for each cable type. Cable runs exceeding the stated maximum run are at risk of issues caused by voltage drop and non performance of equipment.

Cable Type	Max Cable Run
PTZ Combo Cable (RG59+4)	Up To 150m
CAT5+2	Up To 100m
4 Core Cable (0.3mm <sup>2</sup> )	Up To 50m

**Note** Distances stated are based on a monitor powering two door cameras and no auxiliary cameras.

# Wiring A System - Cabling

## PTZ Combo Cable (RG59+4) - Up To 150m

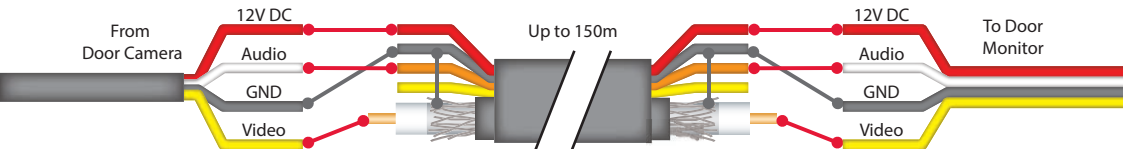

## CAT5+2 - Up To 100m

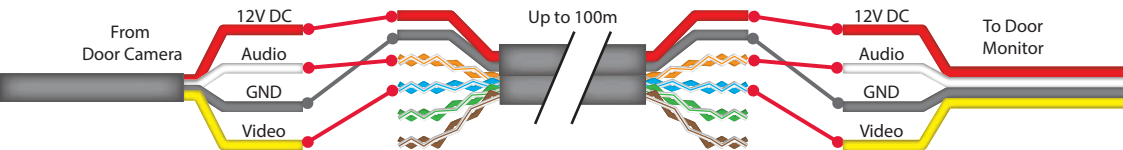

## 4 Core Cable (0.3mm<sup>2</sup>) - Up To 50m

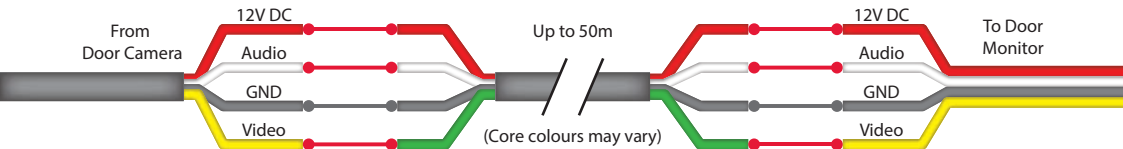

# Wiring A System - Wiring Diagram

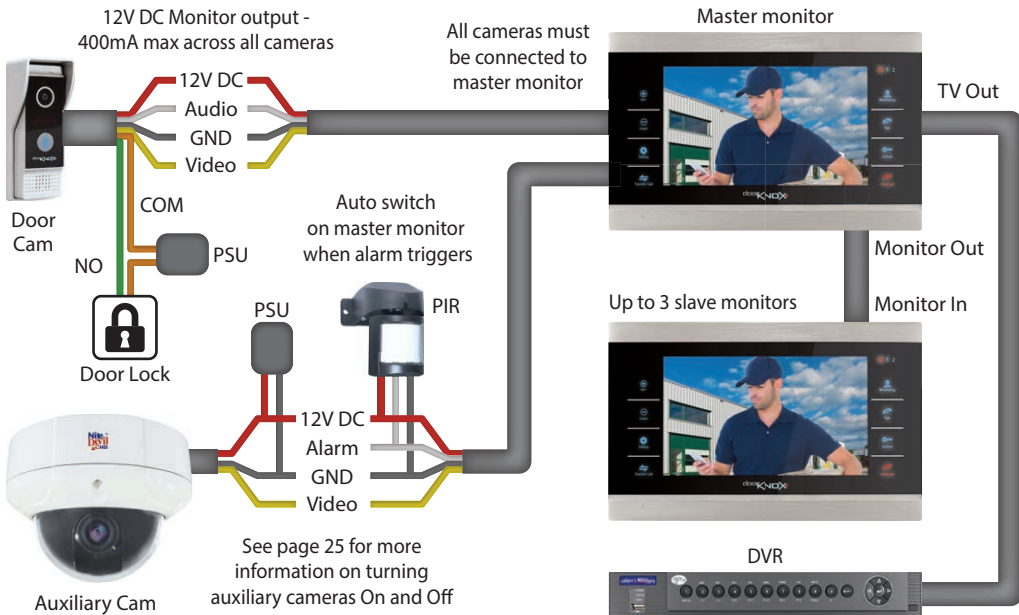

# Using The Menu System

Our door monitors all use the same easy to use menu system. Here you can configure each monitor to meet your requirements. From simple tasks like setting the time and date to setting door release times, ringtones or back up images and recordings.

For information on menu controls see pages 13-15.

## Main Menu

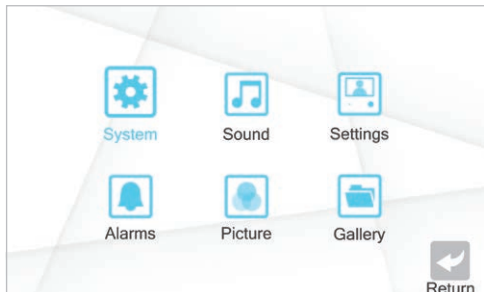

To enter the main menu press the **Settings** button (⚙️) and the main menu will be displayed as shown

above. From the main menu you can access the **System, Sound, Settings, Alarms, Picture** and **Gallery** sub menus.

## System Menu

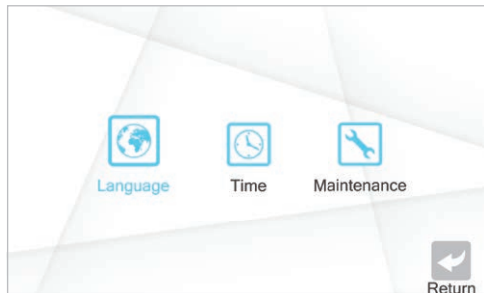

As the name suggests the System menu allows you to configure key system settings. There are three submenus available, **Language, Time** and **Maintenance**.

# Using The Menu System

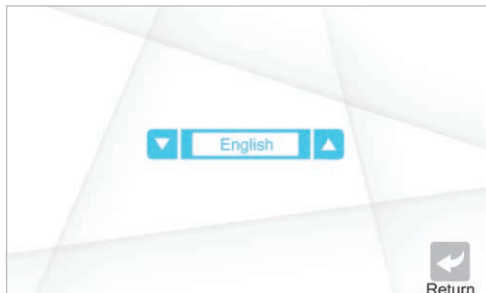

The **Language** submenu allows you to specify the system menu. You can choose from English, Russian or simplified Chinese.



In the **Time** submenu you can set the time, date and date format to determine how the date is displayed. There are three date formats available DD/MM/YY, MM/DD/YY and YY/MM/DD.

# Using The Menu System

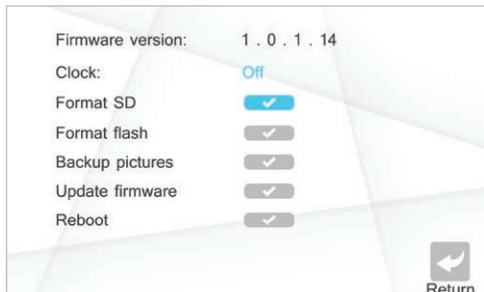

The last option in the System menu is the **Maintenance** screen. The following information and actions can be found here:

**Firmware Version** - Shows the firmware currently installed on the monitor.

**Release Date** - Shows when the currently installed firmware was released.

**Clock** - Tells the monitor what action to take after 2 minutes of inactivity. With Clock turned **Off** the screen

will turn off and the monitor will go into standby. With Clock turned **On** when the monitor goes into standby it will display a digital clock showing the time and date.

**Format SD** - Format the SD card inserted in the monitor erasing all data. You will need to format all SD cards when inserted for the very first time.

**Backup Pictures** - Only available when an SD card has been inserted, this option allows you to backup snapshots from the monitor's internal memory on to the SD card.

**Update Firmware** - This function allows you to update the monitor's firmware from an SD card. The update file needs to be saved directly onto the SD card from a PC and must be saved in the root directory, not within a folder.

After the firmware has been updated the monitor will automatically reboot, the firmware is deleted off the SD card and the DoorKnox folder structure is created.

**Reboot** - Allows you to reboot the monitor if needed returning all settings back to default.

# Using The Menu System

## Sound Menu

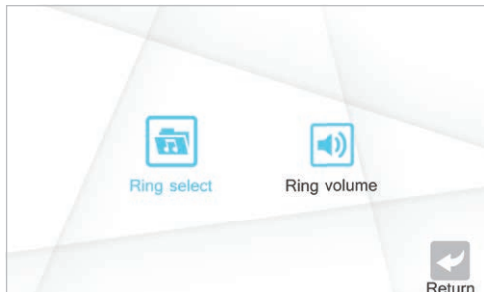

The Sound menu consists of the **Ring Select** and **Ring Volume** sub menus which allow you to adjust all aspects of the audio alerts heard when the door cameras are activated.



In the **Ring Select** menu you can set the ringtone used when the door camera's call button is pressed. There are 12 ringtones to choose from and each door camera can be assigned a unique tone.

Having a different tone for each door is a great way to quickly distinguish which entrance visitors have chosen to use.



# Using The Menu System

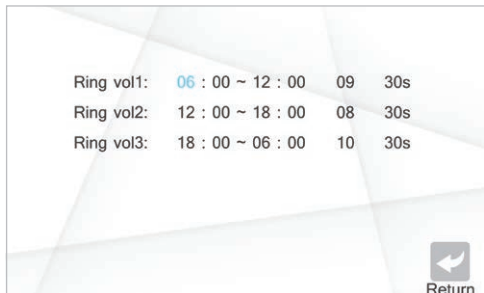

In the **Ring Volume** menu you can create a bespoke schedule to manage ring volume and duration during three different periods of the day.

You first set the time period you wish the new configuration to cover e.g. 06:00~12:00.

Once the time has been set you then set the ring volume for this period. The volume can be set between 1 to 10 with 1 being the quietest and 10 being the loudest. You can also set the ring volume to silent by selecting 0.

Finally you set the ring duration choosing anywhere between 10 and 45 seconds.

## Settings Menu

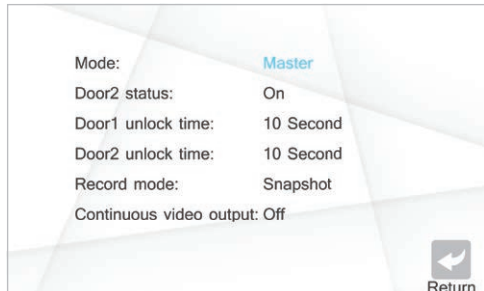

The **Settings** menu allows you to configure key attributes of the door entry system:

**Mode** - Lets you set the monitor as a **Master** or **Slave**. The main monitor which all the cameras are connected to needs to be set as the master (see page 20).

*continued overleaf*

# Using The Menu System

Up to 3 additional monitors can be added to the system however these need to be set as slaves.

**Door2 Status** - Allows you to turn the second door camera **On** or **Off**. When turned off the second door camera can not be used and pressing the call button will have no effect. This feature is also useful on single camera systems as when turned off Door2 will no longer appear when cycling through inputs.

**Door1 Unlock Time** - Controls how long the electronic door lock connected to door camera 1 is released for when unlocked by a door monitor. The unlock time can be set between 2 and 10 seconds.

**Door2 Unlock Time** - Controls how long the electronic door lock connected to door camera 2 is released for when unlocked by a door monitor. The unlock time can be set between 2 and 10 seconds.

**Record Mode** - Determines what is captured when a door camera's call button is pressed. **Snapshot** will capture a single image where as **Record** will capture a video recording up to 2 minutes long. Images are saved into the internal memory as JPEGs

unless an SD card is present in which case they will be automatically saved to the card. Recordings are saved onto the SD card as AVI files. Record can only be chosen when an SD card has been inserted. Additional snapshots and recordings can be captured during a call or when monitoring cameras as explained on **page 31**.

**Continuous Video Output** - Enable or disable the continuous video output to a DVR or TV from the master monitor. The continuous video output will show whichever camera input is being viewed on the master monitor. For more information on connecting to a DVR **see page 31**.

# Using The Menu System

## Alarms Menu

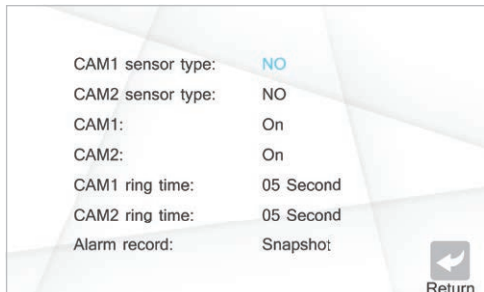

In the **Alarms** menu you can configure everything related to the auxiliary cameras and alarms used for intruder detection.

**CAM1 Sensor Type** - Set the alarm type for the trigger connected to camera 1. You can set it to NO (Normally Open), NC (Normally Closed) or disable it if there is no alarm connected.

**CAM2 Sensor Type** - Set the alarm type for the trigger

connected to camera 2. You can set it to **NO** (Normally Open), **NC** (Normally Closed) or disable it if there is no alarm connected.

**CAM1** - Enable or disable auxiliary camera 1. When disabled the camera output can be activated by an alarm and CAM1 will not show when cycling through available inputs.

**CAM2** - Enable or disable auxiliary camera 2. When disabled the camera output can be activated by an alarm and CAM2 will not show when cycling through available inputs.

**CAM1 Ring Time** - Choose the duration of time the alarm tone will be played for on an alarm trigger for camera 1. The ring time can be set between 0 and 30 seconds.

**CAM2 Ring Time** - Choose the duration of time the alarm tone will be played for on an alarm trigger for camera 2. The ring time can be set between 0 and 30 seconds.

**Alarm Record** - Determines what is captured when an alarm is triggered. **Snapshot** will capture a single image where as **Record** will capture a video recording up to 2 minutes long.

# Using The Menu system

## Picture Menu

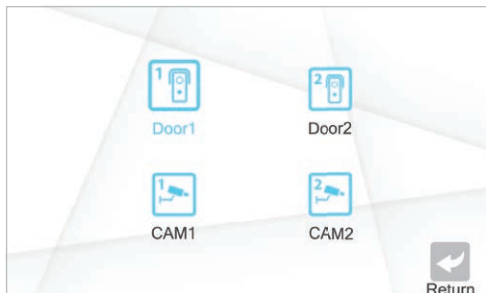

In the **Picture** menu you can set the brightness, contrast and saturation for each camera independently. Configuring each camera's picture settings individually ensures the best results as each camera is usually installed into a slightly different environment.

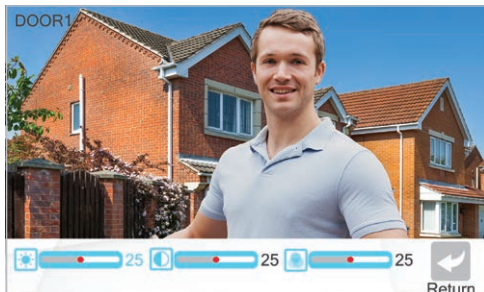

In the **Picture Settings** screen the following three parameters can be adjusted:



**Brightness** - from 0 to 50.



**Contrast** - from 0 to 50.



**Saturation** - from 0 to 50.

# Using The Menu system

## Gallery

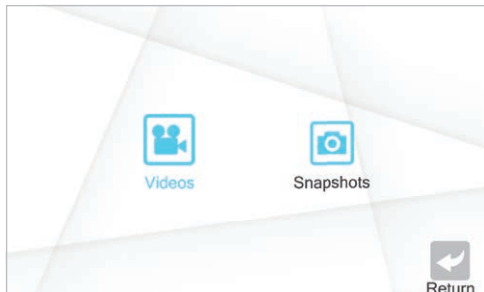

The **Gallery** is where all of the automatically and manually captured snapshots and recordings can be found. The captured files are organised into **Videos** and **Snapshots**.

Snapshots are saved as JPEGs on to the monitor's internal storage or SD memory card. Recordings are saved as 2 CIF quality AVI files on to the SD memory card. To backup the snapshots on to the memory card **see page 23**.

Inside the **Videos** and **Snapshots** folders you will see

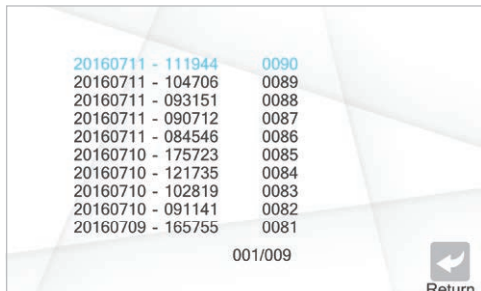

a list of all captured files of that nature. The files are named with the date and time on which they were captured and are formatted as YYYYMMDD - HHMMSS.





When selecting a file you will have the option to play or view the captured file, delete the currently selected file or delete all files in the folder.

When viewing a file you can use the **Up** and **Down** buttons/switch to move on to the next or previous file.

**Note:** After 20 snapshots are captured all snapshots are automatically transferred to the SD card.

# Using The Door Entry System



## Visitor Calls

- 1 When a visitor presses the call button on a door camera the ringtone will be played and their image will be displayed on all door monitors.
- 2 To answer the call press the **Talk** button .
- 3 You now have three options available:
  - A. **Transfer** the call to another door monitor by pressing the **Transfer** button . The call can then be picked up on another monitor using the **Talk** button .
  - B. **Hang Up** when you have finished talking to the visitor. To end the call and return the monitor to standby press the **Hang Up** button .

- C. **Unlock** the door and allow the visitor into the building using the **Unlock** button . The camera's image will be displayed for a further 20 seconds so you can be sure the visitor has entered the building after which the display will turn off automatically. An appropriate electronic door release will need to have been fitted to successfully use this feature.

All calls will be automatically terminated after 2 minutes. This feature is designed to free up the door monitor if the operator forgets to end the call.



## Intercom (Internal Calls)

- 1 To start an internal call (audio only) between monitors press the **Transfer** button .
- 2 To answer the call press the **Talk** button  on any other connected monitor.
- 3 To end the call press the **Hang Up** button .

# Using The Door Entry System

## Monitoring Cameras

You can monitor any camera at anytime by pressing the **Monitor** button  to cycle through camera inputs.

If you are monitoring a door camera you can open two way audio by pressing the **Talk** button  or open the door by pressing the **Unlock** button .

When monitoring cameras the door monitor will return to standby after 60 seconds of inactivity.

## Manually Capture Snapshots & Videos

You can manually capture snapshots or start and stop video recordings during a call or when monitoring cameras by pressing the **Settings** button .

Pressing the Settings button will only capture a snapshot or a recording depending on which is set as the **Record Mode** in the **Settings** menu on page 27.



## Connecting To A DVR

When connecting a door monitor to a DVR the settings used depend on the intended function of the camera.

If you intend yo use the door camera as a 24/7 CCTV camera looking over a forecourt for example, you need to enable **Constant Video Output** in the **Settings** menu on the door monitor. See page 26.

If you only want the DVR to record when a visitor calls you will need to disable **Constant Video Output**. The monitor will then only output an image when the monitor's screen is active (not in standby or clock). The DVR is then set to record only on **motion detection** for the channel the door monitor is connected to. This way the DVR will only record when the door monitor is outputting an image and not hours of no signal.

## Monitor Volume Control

To set the monitor's volume simply press the Monitor button  to display a camera and then use the Up  and Down  buttons/switch to adjust the volume.

# Fault Finding

Each DoorKnox system is tested at our production facility to ensure a quality product is delivered to you and works straight out of the box. From time to time an issue may arise with your installation that can often be rectified on site by making the following checks:

## Poor Connections

A poor lead connection may cause signal loss or interference so check that each component is firmly plugged in and any joints (soldered or otherwise) have been well made off with no shorts or crossed wires.

## Lack Of Power

Again this may cause a lack of picture or other intermittent results. Check your equipment works on a short lead to rule out unsuitable cable runs. Ensure that each add-on item such as cameras, PIRs etc. have their own adequate power supply source. Finally try powering the unit locally with a suitably rated power supply unit. See each individual product specification for help on this.

## Long Cable Runs Causing Signal Loss

A long cable run may result in poor or complete signal loss.

Firstly check if this is the cause by testing the camera and screen on a short test cable. If the problem disappears then both units are working correctly. Next check you are using an appropriate cable for the run as shown on **page 18**. If your cable is below specification then it will need replacing with a more suitable heavier duty cable. If this is impossible as a last resort you may try powering the DoorKnox camera locally to see if this eradicates the problem.

**All above checks should be carried out in any situation where one unit does not appear to be receiving a signal whether video, audio or data from another unit.**

## Key fob Not Working

If you hear 2 short beeps when swiping the key fob it means the key fob has not been successfully paired. Each door entry panel used must be paired with each key fob used. Refer to **page 10** for programming steps.

## Passcode Not Working

If you hear 2 short beeps when the passcode is entered it means it has not been successfully stored. Remember each door entry panel used must be programmed with each code used. Refer to **page 10** for programming steps.



# Other Products To Consider

## 11 Reasons the alien MEGA Hero™ is great value for money



1. **An Easy Upgrade Path** - HD-TVI uses standard RG59 75 ohm CO-AX cable so no need to re-cable for an upgrade.
2. **No Network Configuration or Modification is Required** - less call backs to a network that you didn't install.
3. **Standalone so Immune to Network Interruptions** - only needs connection to the customer's router.
4. **Near Zero Latency (Video Delay)** - so no dreaded buffering effect on your recordings.
5. **High Resolution Images** - HD-TVI offers 20x the picture quality of a basic analogue (CIF quality) recorder.
6. **Global Non-proprietary System** - so more equipment choice and the prices aren't held artificially.
7. **Reliable** - by choosing good quality RG59 cable, the camera's HD signal does not need compressing like an IP camera.
8. **TVI has a High Resistance to EM Interference** - so much longer cabling runs (up to 500m).
9. **Plug and Play** - Co-ax cable and BNCs make installation simple for installers, no network knowledge is required.
10. **Future-proof Triple Technology** - triple technology allows analogue, IP and HD-TVI to be used in the same unit.
11. **TVI 2.0 Technology** - makes HD cameras and DVRs even more affordable & reliable.

# Other Products To Consider

## Programmable Audio Alarm Unit



- Trigger Up To 9999 Sounds
- 20 Alarm Inputs Trigger 20 Recordable Warnings
- Removable SD Card
- Talkback Function
- RS232 Connection
- Weatherproof
- Activate Remotely Over The Internet
- Additional Sound Files Can Be Downloaded at [www.voiceoff.com](http://www.voiceoff.com)

The VoiceOff is an alarm activated voice or sound warning unit that has 20 separate alarm inputs, to trigger up to 20 different recorded sound files. RS232 inputs trigger up to 9999 sounds! Over 1000 pre-recorded sounds and messages are available for use at [voiceoff.com](http://voiceoff.com).

Warning messages can be downloaded or recorded in MP3 format and stored on the removable SD card. These sounds can be used to welcome visitors, deter intruders, warn or inform people as they enter certain areas.

Order Code: **VOX200**

# Other Products To Consider

## Covert 1080p HD-TVI Keyswitch Camera

- Dual HD-TVI & Analogue
- 3.7mm Fixed Module Inside
- Ideal For Entrances

This cleverly designed keyswitch camera hides a small 1080p HD-TVI module with a fixed 3.7mm lens. Available in four designs to blend into any environment.



- A. Isolator: [SEE486](#)  
B. Isolator Alt: [SEE486B](#)  
C. Aircon Boost: [SEE486C](#)  
D. Solar Control: [SEE486D](#)



## Pre-Printed CCTV Warning Signs



- Unique sign ID & QR Code
- Pre-drilled Mounting Holes
- Anti Glare Plastic
- Rounded Corners
- AntiFade Ink
- Weatherproof
- Data Compliant Ready
- Free Scheme Registration

A4 Sign: [SIG550](#)

A3 Sign: [SIG650](#)

## Installer details:

*All specifications are approximate. We reserve the right to change any product specifications or features without notice. Whilst every effort is made to ensure that these instructions are complete and accurate, TVision cannot be held responsible in any way for any losses, no matter how they arise, from errors or omissions in these instructions, or the performance or non-performance of the equipment that these instructions refer to.*



WEE/CG0783SS

This symbol on the products and/or accompanying documents means that used electronic equipment must not be mixed with general household waste. For treatment, recovery and recycling please return this unit to your trade supplier or local designated collection point as defined by your local council.