

Add more **ZIP**® to your CCTV!



## Instruction Manual

Zip NVR Manual

# Table of Contents

<b>Part 1 Overview</b>	<b>1</b>
1 Introduction .....	1
2 Specification .....	3
3 Installation Guidelines .....	4
<b>Part 2 Models</b>	<b>4</b>
1 Zip Non-PoE NVR .....	5
ZIP104 - Rear Panel .....	6
ZIP104 - Front Panel .....	7
ZIP108 - Rear Panel .....	8
ZIP108 - Front Panel .....	9
ZIP116 - Rear Panel .....	10
ZIP116 - Front Panel .....	11
2 Zip PoE NVR .....	12
ZIP204 - Rear Panel .....	13
ZIP204 - Front Panel .....	14
ZIP208 - Rear Panel .....	15
ZIP208 - Front Panel .....	16
ZIP216 - Rear Panel .....	17
ZIP216 - Front Panel .....	18
ZIP226 - Rear Panel .....	19
ZIP226 - Front Panel .....	20
<b>Part 3 Setup</b>	<b>22</b>
1 Setup - Admin Setup .....	22
2 Setup - Hard Drive Installation .....	25
3 Setup - Powering .....	26
<b>Part 4 Operation</b>	<b>27</b>
1 Operation - IR Remote Control .....	28
2 Operation - USB Mouse Control .....	30
3 Operation - Virtual Keyboard .....	31
4 Operation - Live View Menu .....	32
Operation - Live View Menu - Manual Mode .....	34
Operation - Live View Menu - Info Screen .....	35
5 Operation - Live View Toolbar .....	39
Operation - Live View Toolbar - PTZ Controls .....	40
Operation - Live View Toolbar - PTZ Controls - PTZ .....	41
Operation - Live View Toolbar - PTZ Controls - Preset .....	43
Operation - Live View Toolbar - Digital Zoom .....	46
Operation - Live View Toolbar - Colour Settings .....	47
Operation - Live View Toolbar - Add Customised Tag .....	48
<b>Part 5 Smart Setup</b>	<b>49</b>
1 Smart Setup - Network .....	50
2 Smart Setup - Date & Time .....	53

3 Smart Setup - Disk Drives .....	55
4 Smart Setup - Resolution .....	56
5 Smart Setup - Mobile Settings .....	56
6 Smart Setup - P2P .....	58
<b>Part 6 Live View</b>	<b>59</b>
1 Live View - Screen Display .....	59
2 Live View - Status .....	61
3 Live View - Camera Position .....	62
4 Live View - Camera Overlays .....	63
<b>Part 7 Playback</b>	<b>64</b>
1 Playback Toolbar Explained .....	65
Playback Toolbar - Digital Zoom .....	68
Playback Toolbar - Snipping Tool .....	69
Playback Toolbar - Tags .....	71
2 Playback - General .....	72
3 Playback - Backup .....	75
Playback - Backup Preview .....	81
4 Playback - Sub-periods .....	83
5 Playback - Instant Detective .....	86
Playback - Instant Detective - Detecion Area .....	90
6 Playback - Tag .....	93
Playback - Tag - Playback .....	96
7 Playback - External File .....	99
8 Playback - Picture .....	101
Playback - Picture - Preview .....	105
9 Playback - Slice .....	107
Playback - Slice - Playback .....	110
<b>Part 8 Main Menu</b>	<b>112</b>
<b>Part 9 Video Menu</b>	<b>113</b>
1 Video Menu - Video .....	114
Video Menu - Video - USB Wireless .....	115
Video Menu - Video - IP Channels .....	118
Video Menu - Video - IP Channels - Connecting IP Cameras To An NVR .....	119
Video Menu - Video - IP Channels - Adding Zip IP Cameras .....	123
Video Menu - Video - IP Channels - Searching For Cameras .....	125
Video Menu - Video - IP Channels - IP Camera Settings .....	127
Video Menu - Video - IP Channels - Default Passw ords .....	129
Video Menu - Video - IP Channels - Adding Single IP Cameras .....	131
Video Menu - Video - IP Channels - Adding Multiple IP Cameras .....	133
Video Menu - Video - IP Channels - Adding Cameras From A Zip Recorder .....	135
Video Menu - Video - IP Channels - Adding Multiple Cameras From A Zip Recorder .....	138
Video Menu - Video - IP Channels - Adding Cameras From An Alien DVR .....	140
Video Menu - Video - IP Channels - Managing IP Cameras .....	142
Video Menu - Video - Protocol Manage .....	145
2 Video Menu - Live .....	147

Video Menu - Live - Setup .....	149
<b>3 Video Menu - Image Control .....</b>	<b>151</b>
<b>4 Video Menu - PTZ .....</b>	<b>155</b>
<b>5 Video Menu - Video Cover .....</b>	<b>157</b>
<b>6 Video Menu - Motion .....</b>	<b>159</b>
Video Menu - Motion - Setup .....	160
<b>7 Video Menu - Smart .....</b>	<b>163</b>
Video Menu - Smart - PID .....	163
Video Menu - Smart - PID Setup .....	164
Video Menu - Smart - LCD .....	167
Video Menu - Smart - LCD Setup .....	168
Video Menu - Smart - SOD .....	171
Video Menu - Smart - SOD Setup .....	172
Video Menu - Smart - PD .....	175
Video Menu - Smart - PD Setup .....	176
Video Menu - Smart - FD .....	180
Video Menu - Smart - FD Setup .....	181
Video Menu - Smart - CC .....	186
Video Menu - Smart - CC - Setup .....	187
Video Menu - Smart - Sound Detection .....	190
Video Menu - Smart - Sound Detection - Schedule .....	191
Video Menu - Smart - Lens Covered .....	193
Video Menu - Smart - Schedule .....	195
Video Menu - Smart - Intelligent Analysis .....	197

**Part 10 Record Menu 198**

<b>1 Record - Encode .....</b>	<b>199</b>
Record - Encode - Mainstream .....	199
Record - Encode - Substream .....	203
Record - Encode - Mobilestream .....	206
<b>2 Record - Record .....</b>	<b>209</b>
Record - Record Schedule .....	211
<b>3 Record - Capture .....</b>	<b>213</b>
Record - Capture Schedule .....	216

**Part 11 Alarm Menu 218**

<b>1 Alarm Menu - Motion .....</b>	<b>220</b>
<b>2 Alarm Menu - I/O .....</b>	<b>223</b>
<b>3 Alarm Menu - Smart .....</b>	<b>226</b>
<b>4 Alarm Menu - PTZ Linkage .....</b>	<b>230</b>
<b>5 Alarm Menu - Exception .....</b>	<b>233</b>
Alarm Menu - Exception - Disk Error .....	237
<b>6 Alarm Menu - Alarm Schedule .....</b>	<b>239</b>

**Part 12 Network Menu 241**

<b>1 Network Menu - General .....</b>	<b>243</b>
Network Menu - General - PPPoE .....	245
Network Menu - General - Port Configuration .....	247
<b>2 Network Menu - DDNS .....</b>	<b>250</b>
<b>3 Network Menu - Email .....</b>	<b>252</b>



Network Menu - Email - Email Schedule .....	255
<b>4 Network Menu - FTP .....</b>	<b>257</b>
Network Menu - FTP Shcedule .....	260
<b>5 Network Menu - IP Filter .....</b>	<b>262</b>
<b>6 Network Menu - Voice Assistant .....</b>	<b>264</b>
<b>Part 13 Storage Menu .....</b>	<b>265</b>
1 Storage Menu - Disk .....	266
2 Storage Menu - Disk - S.M.A.R.T .....	268
3 Storage Menu - Cloud .....	270
<b>Part 14 System Menu .....</b>	<b>273</b>
1 System Menu - General .....	275
System Menu - General - ZIP Channel .....	277
System Menu - General - Date And Time .....	279
System Menu - General - Ouput Configuration .....	282
System Menu - General - Output Configuration - Live Out .....	283
System Menu - General - Output Configuration - Spot Out .....	285
2 System Menu - Multi-User .....	288
System Menu - Multi-User - User Edit .....	290
System Menu - Multi-User - Permission .....	293
3 System Menu - RS485 .....	295
4 System Menu - Maintenance .....	297
System Menu - Maintenance - Log .....	297
System Menu - Maintenance - Load Default .....	300
System Menu - Maintenance - Upgrade .....	301
System Menu - Maintenance - Settings Save/Load .....	302
System Menu - Maintenance - Auto Reboot .....	303
5 System Menu - IP Camera Maintenance .....	304
System Menu - IP Camera Maintenance - Upgrade .....	305
System Menu - IP Camera Maintenance - Load Default .....	306
System Menu - IP Camera Maintenance - Reboot IPC .....	307
System Menu - IP Camera Maintenance - Settings Save/Load .....	308
6 System Menu - Information .....	310
System Menu - Information - Channel Information .....	312
System Menu - Information - Record Information .....	314
System Menu - Information - Network State .....	316
<b>Part 15 Common Interfaces .....</b>	<b>317</b>
1 Backup .....	317
2 Parameter Copy .....	319
<b>Part 16 Shutdown .....</b>	<b>321</b>
<b>Part 17 How To .....</b>	<b>322</b>
1 Setup Email .....	323
Setup Em ail - Gm ail .....	323
Setup Em ail - Yahoo .....	326
2 Recover Forgotton Password .....	329

<b>Part 18 Useful Links</b>	<b>330</b>
<b>Part 19 Software &amp; Apps</b>	<b>331</b>
<b>Part 20 Troubleshooting</b>	<b>333</b>
<b>Part 21 Conditions</b>	<b>337</b>
<b>Index</b>	<b>339</b>

## Overview

Add more **ZIP®** to your CCTV!



### 1.1 Introduction

The new Zip range of IP cameras and NVRs has been designed with the CCTV installer and end-user in mind; it's simple to fit and very easy to use. Picture quality is superb with the Zip NVR range being able to record up to 4K.

#### Easy Fit CCTV

If you are looking to fit an IP CCTV system that really is about as easy as it can get the ZIP IP system is for you. If you buy the ZIP IP cameras and ZIP PoE NVR, the NVR will power the cameras down the CAT5/6 cable saving you the need or inconvenience of a separate PSU for the cameras. This makes for an easy, rapid installation that both looks neat and is effortless.

#### Types of NVR

There are two types of Zip NVR, a Power over Ethernet model "PoE" that powers your IP cameras directly and a lower cost non-PoE model.

Typically you would use the non-PoE model where you cannot directly connect your Zip IP cameras to the Zip NVR e.g on a large existing corporate network that you are piggybacking onto. In this case, because the PoE will not go through an existing network to power the Zip camera, the PoE switch becomes redundant so the non-PoE model saves you money.

Not only does the Zip PoE NVR power your cameras it will autodetect Zip IP PoE cameras and auto-configures them for you. So you do not have the issue of having to individually set new IP settings to match those of the router. Of course you can still do this manually if you switch off this autodetect (Switch) function or if you are not adding Zip PoE cameras. If you have a mixture of both Zip PoE cameras and other IP cameras, you can set the autodetect (Switch) option first and

connect the Zip PoE cameras automatically, then switch the option off and add the remaining IP cameras manually.

## 1.2 Specification

	Non-PoE NVRs			PoE NVRs			
Channels	4	8	16	4	8	16	32
ONVIF Version	2.6			2.6			
Compression	H265 / H264			H265 / H264			
PoE Cameras	-			Yes - 4 Max	Yes - 8 Max	Yes - 16 Max	Yes - 16 Max
Network Cameras	4 Max	8 Max	16 Max	4 Max	8 Max	16 Max	32 Max
Camera Connections	1x LAN	1x LAN	1x LAN	1x LAN / 4x RJ45 (PoE)	1x LAN / 8x RJ45 (PoE)	1x LAN / 16x RJ45 (PoE)	1x LAN / 16x RJ45 (PoE)
Network Interface	100Mbps	1000Mbps	1000Mbps	100Mbps	1000Mbps	1000Mbps	1000Mbps
Recording Bandwidth	40Mbps <i>Max Per Channel</i>	100Mbps <i>Max Per Channel</i>	320Mbps <i>Max Per Channel</i>	40Mbps <i>Max Per Channel</i>	100Mbps <i>Max Per Channel</i>	320Mbps <i>Max Per Channel</i>	320Mbps <i>Max Per Channel</i>
Max Recording Resolution	4K <i>Every Channel</i>			4K <i>Every Channel</i>			
Recording Resolution	8MP(4K) / 5MP / 3MP / 2MP(1080P) / 1.3MP(960P) / 1MP(720P)			8MP(4K) / 5MP / 3MP / 2MP(1080P) / 1.3MP(960P) / 1MP(720P)			
Video Outputs	1x HDMI / 1x VGA			1x HDMI / 1x VGA			
Output Resolution	HDMI - 4K (Max) / VGA - 1080p (Max)			HDMI - 4K (Max) / VGA - 1080p (Max)			
Audio Inputs	1x Phono			1x Phono			
Audio Outputs	1x Phono			1x Phono			
Alarm Inputs	4x Hardwired	8x Hardwired	16x Hardwired	4x Hardwired	8x Hardwired	16x Hardwired	16x Hardwired
Alarm Outputs	1x Hardwired			1x Hardwired	1x Hardwired	1x Hardwired	4x Hardwired
Hard Drive*	6TB Max (1x 6TB)	12TB Max (2x 6TB)	24TB Max (4x 6TB)	12TB Max (2x 6TB)	6TB Max (1x 6TB)	24TB Max (4x 6TB)	48TB Max (8x 6TB)
eSATA	No	Yes - 40TB Max	Yes - 40TB Max	No	Yes - 40TB Max	Yes - 40TB Max	Yes - 40TB Max
Communication	RS232 / RS485			RS232 / RS485			
Power	12V DC / 2A	12V DC / 5A	12V DC / 5A	48V DC / 1.2A	48V DC / 2A	52V DC / 2.5A <i>(Built-in)</i>	52V DC / 2.5A 12V DC / 5A <i>(Built-in)</i>
Dimensions	300 x 217 x 53mm	378 x 330 x 50mm	378 x 325.8 x 70mm	378 x 325.8 x 50mm	378 x 325.8 x 50mm	378 x 325.8 x 70mm	440 x 450 x 98mm

\*Our NVRs take the latest 8 and 10TB sizes but we've based our table on a maximum capacity drive size of 6TB as they currently represent the best value for money.

## 1.3 Installation Guidelines

1. Never operate the equipment using an unspecified power supply.
2. Do not install the equipment in a dusty or damp area. Avoid a humid environment.
3. Keep the surface of the equipment clean and dry. Use soft damp cloth to clean the outer case of recorder (do not use liquid aerosol cleaners.)
4. If the system clock fails to work, power down the recorder, remove the top of the case and replace the standard 3V lithium battery on the main board.
5. Always install the recorder in a place with good ventilation ensuring that the ventilation slots are not covered and that there is a good flow of air around the recorder. Due to the heat produced especially by the Hard Drive/s, reducing ventilation can reduce life of the recorder components and the Hard Drive/s.
6. The power adaptor on the recorder must only be used to power one recorder because connecting additional equipment can cause the recorder to reboot due to insufficient power.

## Models

Zip recorders are available in the following models:

### DVR

- Lite 2MP (1080P) up to 16 channels
- Supa 5MP up to 16 channels
- Xtreme 4K (8MP) up to 16 channels

### NVR

- Non-PoE 4K (8MP) up to 16 channels
- PoE 4K (8MP) up to 32 channels

## 2.1 Zip Non-PoE NVR



The Zip Non-PoE NVR is available as 4 channel, 8 channel and 16 channel unit.

### Rear Panel Connections Diagram

- [ZIP104](#) <sup>6</sup> - 4Ch
- [ZIP108](#) <sup>8</sup> - 8Ch
- [ZIP116](#) <sup>10</sup> - 16Ch

### Front Panel Controls

- [ZIP104](#) <sup>7</sup> - 4Ch
- [ZIP108](#) <sup>9</sup> - 8Ch
- [ZIP116](#) <sup>11</sup> - 16Ch

### 2.1.1 ZIP104 - Rear Panel

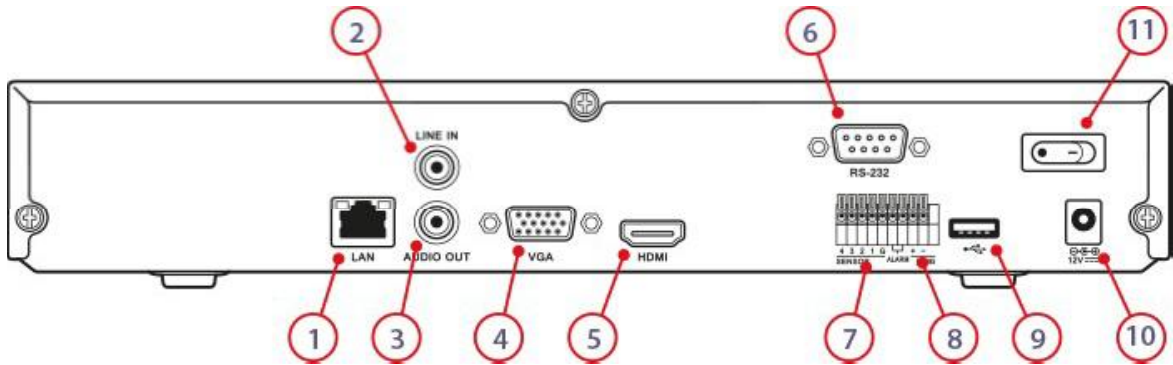

No.	Name	Function
1	LAN Interface	Connector for LAN (Local Area Network). Also used for connecting up to 4 IP cameras.
2	Audio In	RCA/Phono connector for audio input
3	Audio Out	RCA/Phono connector for audio output
4	VGA	DB15 connector for VGA output. Display local video output and menu
5	HDMI	HDMI video and audio output
6	RS232	Connector for RS232 devices such as the VoiceOff
7	Alarm In/Out	Connection for 4 alarm inputs and 1 alarm output
8	RS485 Interface	External keyboard control allows the NVR to be locked away securely
9	USB Interface	USB port for connecting a USB mouse or USB flash memory devices
10	Power	12V DC operation
11	Power Switch	Turn device power On/Off



### 2.1.2 ZIP104 - Front Panel

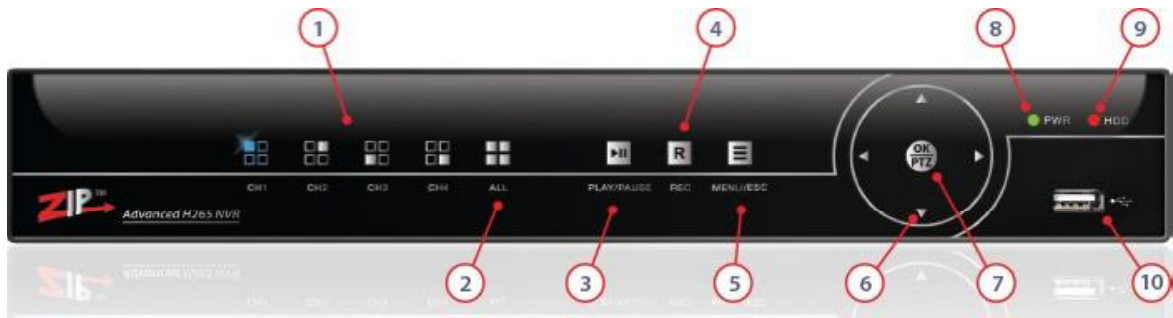

No.	Name	Function
1	CH1 ~ CH4	Display a full screen image for the selected channel
2	ALL	Press to cycle through camera layouts
3	PLAY/PAUSE	View the Playback screen and play/pause playback. A full description of the playback settings are detailed in the <a href="#">Playback Screen</a> <sup>64</sup> section.
4	REC	Switches on continuous recording on the selected channels and overrides the schedule
5	MENU/ESC	Enters the Menu or Escapes the current operation
6	Arrows	Used for navigating menus
7	OK/PTZ	Used for confirming selections and entering sub-menus. When pressed during live it will display the PTZ control buttons
8	PWR	LED lights when power is detected by the DVR
9	HDD	LED lights when the HDD is operational
10	USB	USB2 connection for mouse control or USB backup

### 2.1.3 ZIP108 - Rear Panel

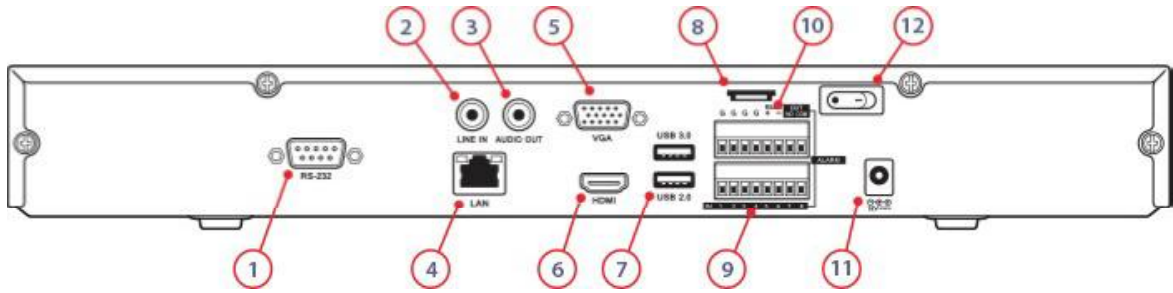

No.	Name	Function
1	RS232	Connector for RS232 devices such as the VoiceOff
2	Audio In	RCA/Phono connector for audio input
3	Audio Out	RCA/Phono connector for audio output
4	LAN Interface	Connector for LAN (Local Area Network). Also used for connecting up to 8 IP cameras.
5	VGA	DB15 connector for VGA output. Display local video output and menu
6	HDMI	HDMI video and audio output
7	USB Interface	1x USB 3.0 and 1x USB 2.0 port for connecting a USB mouse or USB flash memory device
8	e-SATA Interface	e-SATA for added external HDD connections
9	Alarm In/Out	Connection for 8 alarm inputs and 1 alarm output
10	RS485 Interface	External keyboard control allows the NVR to be locked away securely
11	Power	12V DC operation
12	Power Switch	Turn device power On/Off

### 2.1.4 ZIP108 - Front Panel

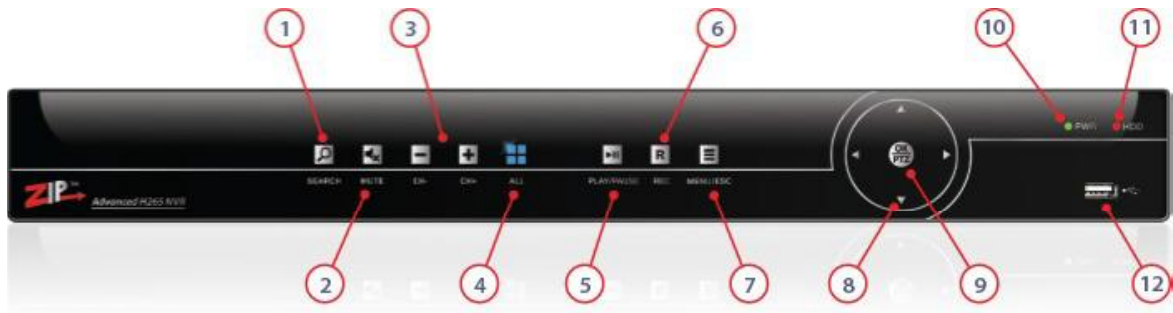

No.	Name	Function
1	SEARCH	View the Playback screen
2	MUTE	Mute and un-mute live audio
3	CH-/CH+	Cycle through channels 1 ~ 8 and display a full screen image for the selected channel
4	ALL	Press to cycle though camera layouts
5	PLAY/PAUSE	View the Playback screen and play/pause playback. A full description of the playback settings are detailed in the <a href="#">Playback Screen</a> <sup>(64)</sup> section.
6	REC	Switches on continuous recording on the selected channels and overrides the schedule
7	MENU/ESC	Enters the Menu or Escapes the current operation
8	Arrows	Used for navigating menus
9	OK/PTZ	Used for confirming selections and entering sub-menus. When pressed during live it will display the PTZ control buttons
10	PWR	LED lights when power is detected by the DVR
11	HDD	LED lights when the HDD is operational
12	USB	USB2 connection for mouse control or USB backup

### 2.1.5 ZIP116 - Rear Panel

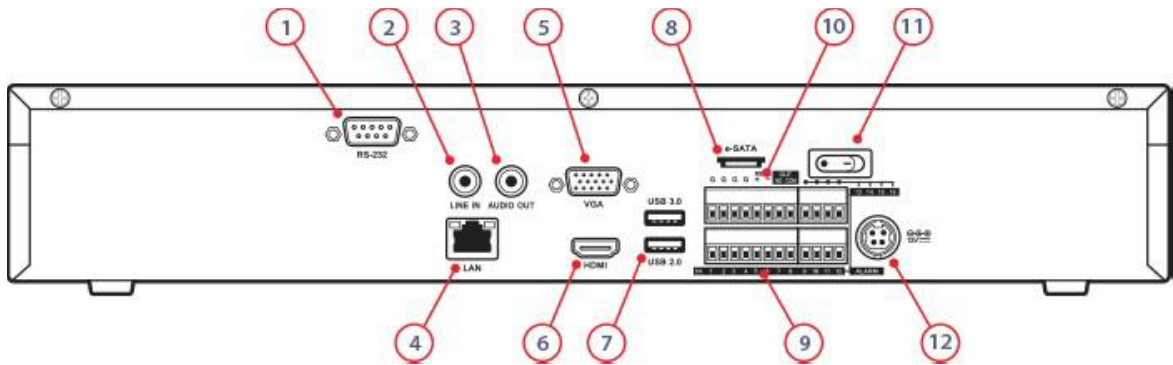

No.	Name	Function
1	RS232	Connector for RS232 devices such as the VoiceOff
2	Audio In	RCA/Phono connector for audio input
3	Audio Out	RCA/Phono connector for audio output
4	LAN Interface	Connector for LAN (Local Area Network). Also used for connecting up to 8 IP cameras.
5	VGA	DB15 connector for VGA output. Display local video output and menu
6	HDMI	HDMI video and audio output
7	USB Interface	1x USB 3.0 and 1x USB 2.0 port for connecting a USB mouse or USB flash memory device
8	e-SATA Interface	e-SATA for added external HDD connections
9	Alarm In/Out	Connection for 16 alarm inputs and 1 alarm output
10	RS485 Interface	External keyboard control allows the NVR to be locked away securely
11	Power Switch	Turn device power On/Off
12	Power	12V DC operation

### 2.1.6 ZIP116 - Front Panel

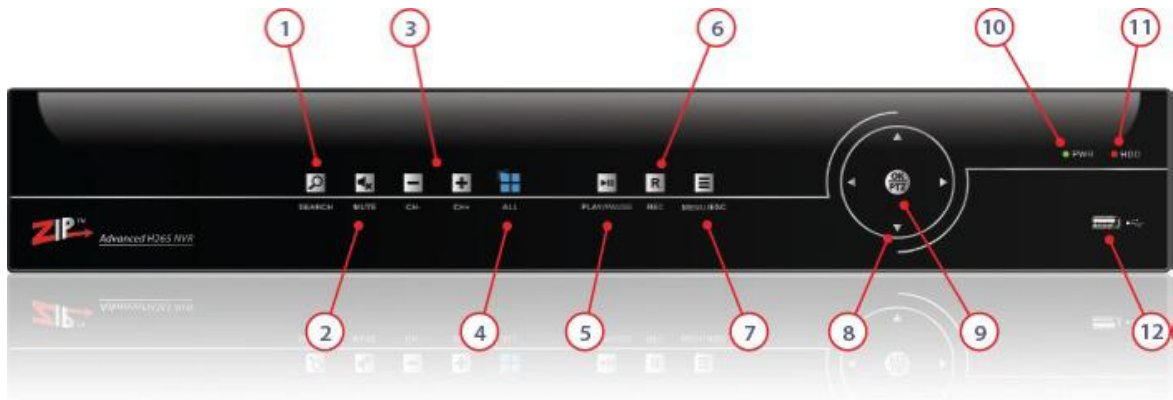

No.	Name	Function
1	SEARCH	View the Playback screen
2	MUTE	Mute and un-mute live audio
3	CH-/CH+	Cycle through channels 1 ~ 8 and display a full screen image for the selected channel
4	ALL	Press to cycle though camera layouts
5	PLAY/PAUSE	View the Playback screen and play/pause playback. A full description of the playback settings are detailed in the <a href="#">Playback Screen</a> <sup>(64)</sup> section.
6	REC	Switches on continuous recording on the selected channels and overrides the schedule
7	MENU/ESC	Enters the Menu or Escapes the current operation
8	Arrows	Used for navigating menus
9	OK/PTZ	Used for confirming selections and entering sub-menus. When pressed during live it will display the PTZ control buttons
10	PWR	LED lights when power is detected by the DVR
11	HDD	LED lights when the HDD is operational
12	USB	USB2 connection for mouse control or USB backup

## 2.2 Zip PoE NVR



The Zip PoE NVR is available as 4 channel, 8 channel, 16 channel and 32 channel unit.

### Rear Panel Connections Diagram

- [ZIP204](#)<sup>13</sup> - 4Ch
- [ZIP208](#)<sup>15</sup> - 8Ch
- [ZIP216](#)<sup>17</sup> - 16Ch
- [ZIP226](#)<sup>19</sup> - 32Ch

### Front Panel Controls

- [ZIP204](#)<sup>14</sup> - 4Ch
- [ZIP208](#)<sup>16</sup> - 8Ch
- [ZIP216](#)<sup>18</sup> - 16Ch
- [ZIP226](#)<sup>20</sup> - 32Ch

### 2.2.1 ZIP204 - Rear Panel

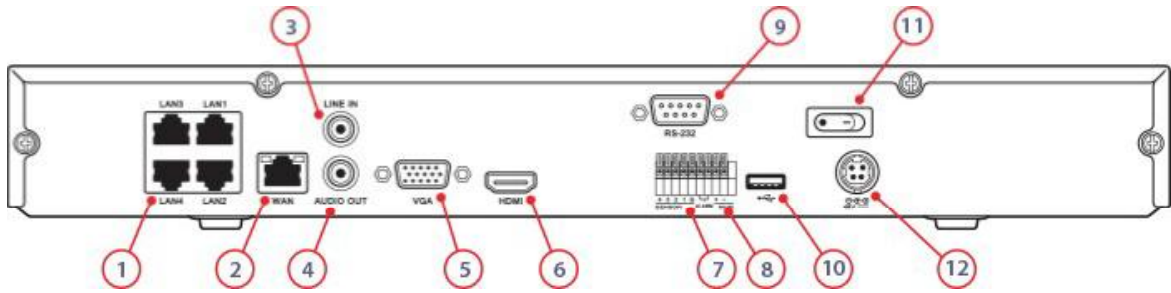

No.	Name	Function
1	VIDEO IN (PoE)	4x RJ45 sockets for video input and PoE output for up to 4 cameras.
2	LAN/WAN Interface	Connector for LAN (Local Area Network) or WAN (Wider Area Network). Also used for connecting up to 4 IP cameras.
3	Audio In	RCA/Phono connector for audio input
4	Audio Out	RCA/Phono connector for audio output
5	VGA	DB15 connector for VGA output. Display local video output and menu
6	HDMI	HDMI video and audio output
7	Alarm In/Out	Connection for 4 alarm inputs and 1 alarm output
8	RS485 Interface	External keyboard control allows the NVR to be locked away securely
9	RS232	Connector for RS232 devices such as the VoiceOff
10	USB Interface	USB port for connecting a USB mouse or USB flash memory devices
11	Power Switch	Turn device power On/Off
12	Power	48V DC operation

### 2.2.2 ZIP204 - Front Panel

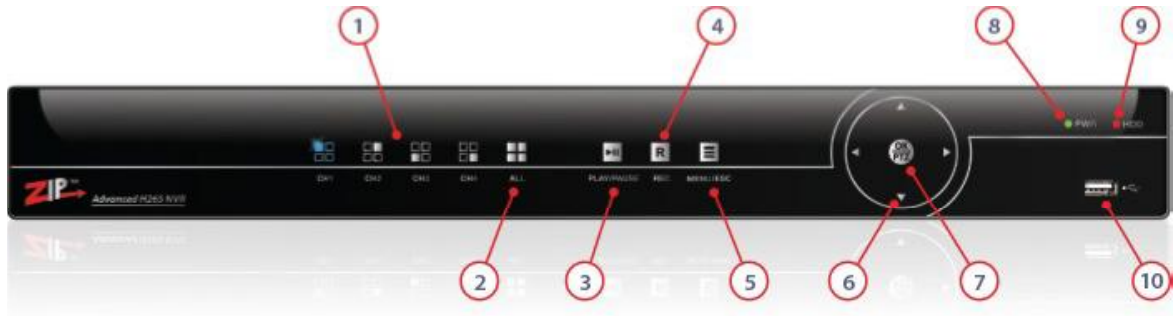

No.	Name	Function
1	CH1 ~ CH4	Display a full screen image for the selected channel
2	ALL	Press to cycle though camera layouts
3	PLAY/PAUSE	View the Playback screen and play/pause playback. A full description of the playback settings are detailed in the <a href="#">Playback Screen</a> <sup>64</sup> section.
4	REC	Switches on continuous recording on the selected channels and overrides the schedule
5	MENU/ESC	Enters the Menu or Escapes the current operation
6	Arrows	Used for navigating menus
7	OK/PTZ	Used for confirming selections and entering sub-menus. When pressed during live it will display the PTZ control buttons
8	PWR	LED lights when power is detected by the DVR
9	HDD	LED lights when the HDD is operational
10	USB	USB2 connection for mouse control or USB backup



### 2.2.3 ZIP208 - Rear Panel

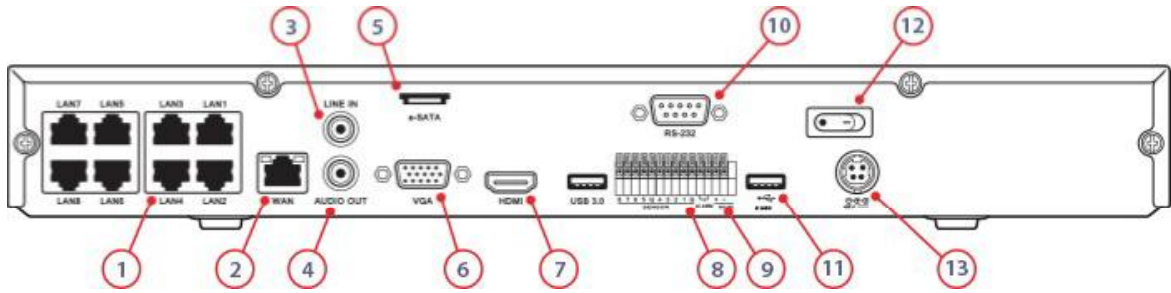

No.	Name	Function
1	VIDEO IN (PoE)	8x RJ45 sockets for video input and PoE output for up to 8 cameras.
2	LAN/WAN Interface	Connector for LAN (Local Area Network) or WAN (Wider Area Network). Also used for connecting up to 32 IP cameras.
3	Audio In	RCA/Phono connector for audio input
4	Audio Out	RCA/Phono connector for audio output
5	e-SATA Interface	e-SATA for added external HDD connections
6	VGA	DB15 connector for VGA output. Display local video output and menu
7	HDMI	HDMI video and audio output
8	Alarm In/Out	Connection for 8 alarm inputs and 1 alarm output
9	RS485 Interface	External keyboard control allows the DVR to be locked away securely
10	RS232	Connector for RS232 devices such as the VoiceOff
11	USB Interface	USB port for connecting a USB mouse or USB flash memory devices
12	Power Switch	Turn device power On/Off
13	Power	48V DC operation

### 2.2.4 ZIP208 - Front Panel

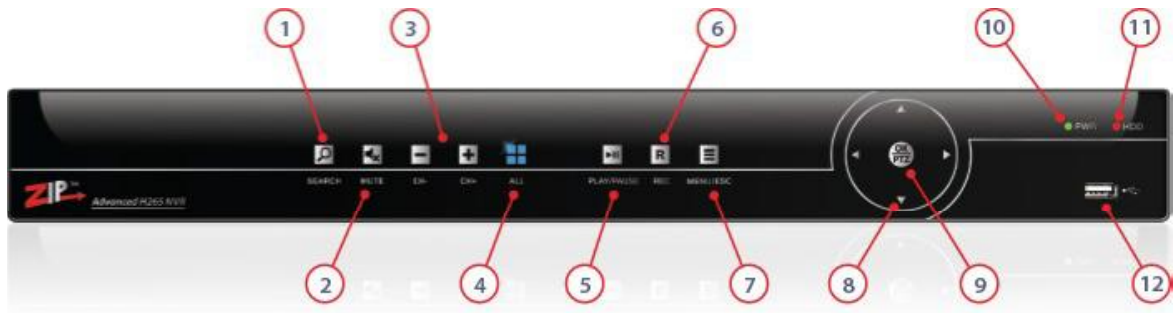

No.	Name	Function
1	SEARCH	View the Playback screen
2	MUTE	Mute and un-mute live audio
3	CH-/CH+	Cycle through channels 1 ~ 8 and display a full screen image for the selected channel
4	ALL	Press to cycle though camera layouts
5	PLAY/PAUSE	View the Playback screen and play/pause playback. A full description of the playback settings are detailed in the <a href="#">Playback Screen</a> <sup>(64)</sup> section.
6	REC	Switches on continuous recording on the selected channels and overrides the schedule
7	MENU/ESC	Enters the Menu or Escapes the current operation
8	Arrows	Used for navigating menus
9	OK/PTZ	Used for confirming selections and entering sub-menus. When pressed during live it will display the PTZ control buttons
10	PWR	LED lights when power is detected by the DVR
11	HDD	LED lights when the HDD is operational
12	USB	USB2 connection for mouse control or USB backup

### 2.2.5 ZIP216 - Rear Panel

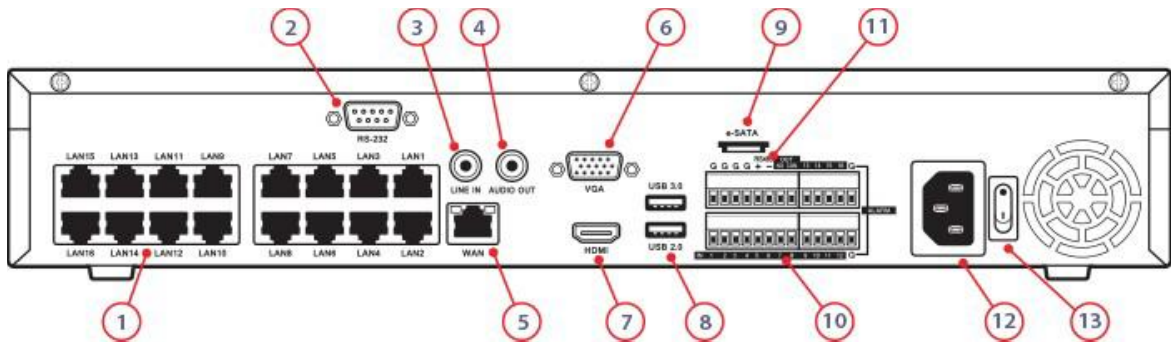

No.	Name	Function
1	VIDEO IN (PoE)	16x RJ45 sockets for video input and PoE output for up to 16 cameras.
2	RS232	Connector for RS232 devices such as the VoiceOff
3	Audio In	RCA/Phono connector for audio input
4	Audio Out	RCA/Phono connector for audio output
5	LAN/WAN Interface	Connector for LAN (Local Area Network) or WAN (Wider Area Network). Also used for connecting up to 16 IP cameras.
6	VGA	DB15 connector for VGA output. Display local video output and menu
7	HDMI	HDMI video and audio output
8	USB Interface	1x USB 3.0 and 1x USB 2.0 port for connecting a USB mouse or USB flash memory device
9	e-SATA Interface	e-SATA for added external HDD connections
10	Alarm In/Out	Connection for 16 alarm inputs and 1 alarm output
11	RS485 Interface	External keyboard control allows the DVR to be locked away securely
12	Power	240V AC operation
13	Power Switch	Turn device power On/Off

### 2.2.6 ZIP216 - Front Panel

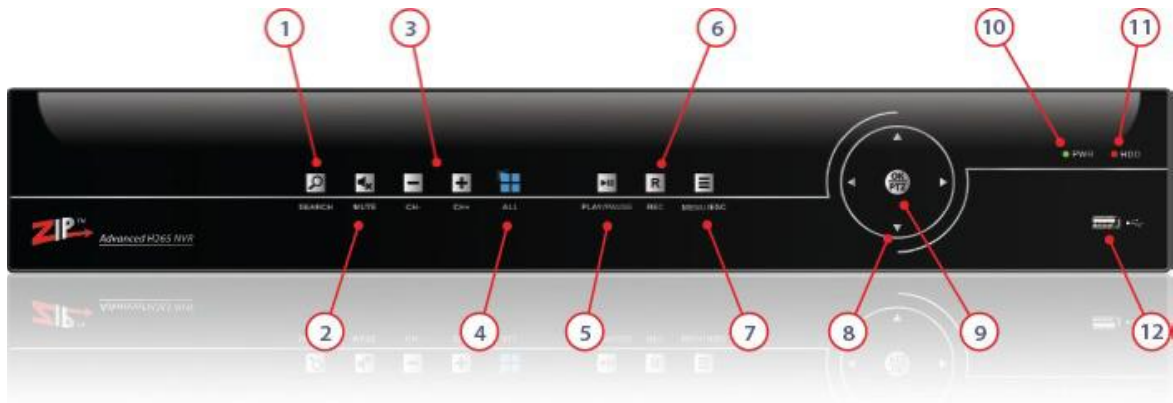

No.	Name	Function
1	SEARCH	View the Playback screen
2	MUTE	Mute and un-mute live audio
3	CH-/CH+	Cycle through channels 1 ~ 8 and display a full screen image for the selected channel
4	ALL	Press to cycle though camera layouts
5	PLAY/PAUSE	View the Playback screen and play/pause playback. A full description of the playback settings are detailed in the <a href="#">Playback Screen</a> <sup>(64)</sup> section.
6	REC	Switches on continuous recording on the selected channels and overrides the schedule
7	MENU/ESC	Enters the Menu or Escapes the current operation
8	Arrows	Used for navigating menus
9	OK/PTZ	Used for confirming selections and entering sub-menus. When pressed during live it will display the PTZ control buttons
10	PWR	LED lights when power is detected by the DVR
11	HDD	LED lights when the HDD is operational
12	USB	USB2 connection for mouse control or USB backup

### 2.2.7 ZIP226 - Rear Panel

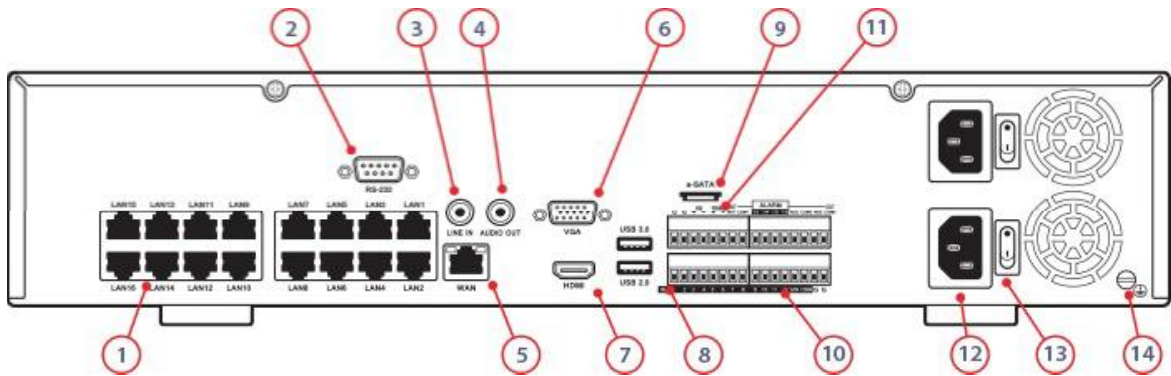

No.	Name	Function
1	VIDEO IN (PoE)	16x RJ45 sockets for video input and PoE output for up to 16 cameras.
2	RS232	Connector for RS232 devices such as the VoiceOff
3	Audio In	RCA/Phono connector for audio input
4	Audio Out	RCA/Phono connector for audio output
5	LAN/WAN Interface	Connector for LAN (Local Area Network) or WAN (Wider Area Network). Also used for connecting up to 32 IP cameras.
6	VGA	DB15 connector for VGA output. Display local video output and menu
7	HDMI	HDMI video and audio output
8	USB Interface	1x USB 3.0 and 1x USB 2.0 port for connecting a USB mouse or USB flash memory device
9	e-SATA Interface	e-SATA for added external HDD connections
10	Alarm In/Out	Connection for 16 alarm inputs and 4 alarm outputs
11	RS485 Interface	External keyboard control allows the DVR to be locked away securely
12	Power	2x 240V AC operation for device and switch
13	Power Switch	Turn device/switch power On/Off

### 2.2.8 ZIP226 - Front Panel

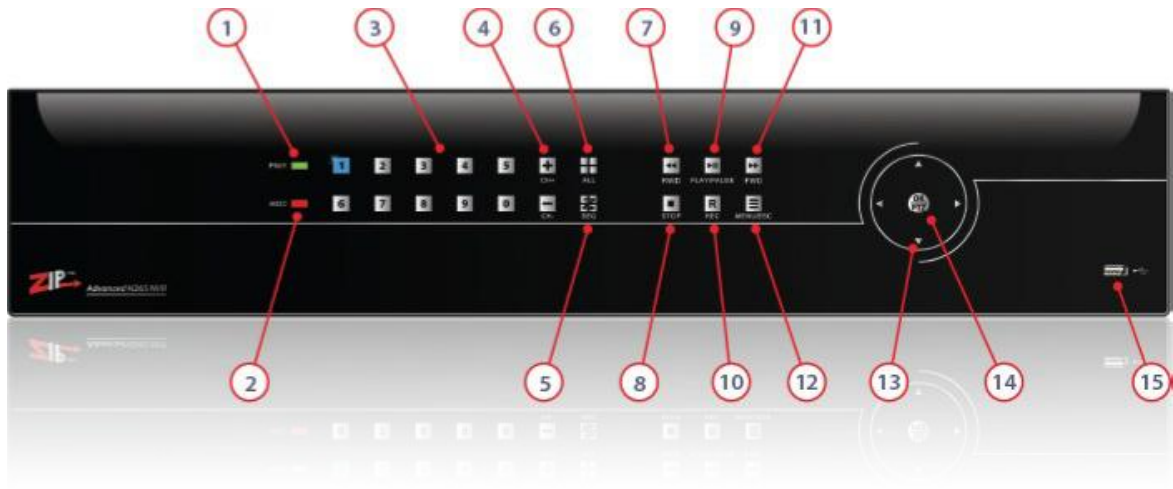

No.	Name	Function
1	SEARCH	View the Playback screen
2	MUTE	Mute and un-mute live audio
3		
4	CH+/CH-	Cycle through channels 1 ~ 32 and display a full screen image for the selected channel
5	PWR	LED lights when power is detected by the DVR
6	HDD	LED lights when the HDD is operational
7	ALL	Press to cycle though camera layouts
8	STOP	Stops playbacl
9	PLAY/PAUSE	View the Playback screen and play/pause playback. A full description of the playback settings are detailed in the <a href="#">Playback Screen</a> <sup>64</sup> section.
10	REC	Switches on continuous recording on the selected channels and overrides the schedule
11	FWD	Fast forward playback
12	MENU/ESC	Enters the Menu or Escapes the current operation
13	Arrows	Used for navigating menus
14	OK/PTZ	Used for confirming selections and entering sub-menus. When pressed during live it will display the PTZ control buttons
15	USB	USB2 connection for mouse control or USB backup

The front panel has touch buttons for **CH-** & **CH+** for selecting Channels 1 – 32 and display a full screen image for the selected channel. Selecting the **ALL** buttons displays a 32 channel screen view followed by a single screen view when touched again. The buttons illuminate in blue when selected.

The **SEQ** button switches sequencing on/off

the **RWD** button fast reverse playback, the **PLAY/PAUSE** button selects the Playback screen, the **FWD** button select fast forward playback and the **STOP** button stops playback. A full description of the playback settings are detailed in the [Playback Screen](#)<sup>64</sup> section.

The **REC** button switches on continuous recording on the selected channels and overrides the schedule.

The **MENU/ESC** enters the Menu or Escapes the current operation.

The **OK/PTZ** button is used for confirming selections and entering sub-menus. When pressed during live it will display the PTZ control buttons.

The **Arrow** buttons are used for navigation.

The **PWR** (Power) LED lights when power is detected by the DVR and the **HDD** LED lights when the HDD is operational.

The front **USB** is a USB2 connection for mouse control or USB backup.

## Setup

The Setup section will guide you through some basic steps required when using the recorder for the first time.

### 3.1 Setup - Admin Setup

When you run the recorder for the first time you are required to set your password immediately in order to protect your privacy.

The screenshot shows a web interface titled "Login" with the following fields and options:

- New Admin Name:** A text input field containing the text "admin".
- Password Strength:** A progress bar indicator showing the strength of the password.
- Admin Default Password:** A text input field with a "Show Password" checkbox to its right.
- New Admin Password:** A text input field with a "Show Password" checkbox to its right.
- Confirm Password:** A text input field with a "Show Password" checkbox to its right.
- Unlock Pattern Enable:** A dropdown menu currently set to "Disable".

An "Apply" button is located at the bottom center of the form.

#### Changing The Admin Username

You can change the admin username if you wish to something more personal in the **New Admin Name** field. This will also boost security as the username is no longer the obvious default username of admin.

#### Setting A Password

As all recorders ship with the same default admin password you will be asked to create a new password for added security. Before you create your new password you will be asked to enter the **Admin Default Password** which is **555555**.

To set a new password enter the desired password into the **New Admin Password** field. You will then need to re-enter the new password into the **Confirm Password** field. This New Admin Password field and the Confirm Password field will be checked against each other to ensure that they match and you haven't accidentally entered the new password incorrectly.



The **Password Strength** bar gives you an indication as to how secure your password is. A low strength password may be easy for somebody to guess where as a high strength password would keep you more secure. Ideally you would aim for as strong of a password as possible by using at least 8 characters and a combination of letters and number.

**Note:** Do not use something obvious like **12345** if the recorder is on a network as this is too weak and easily accessed by malware.

### Password Recovery

We strongly recommend networking your recorder which can be done during [Smart Setup](#)<sup>(50)</sup> or in the [Network](#)<sup>(241)</sup> menu. Once your recorder has been networked you can point the recorder to an email address as shown in the [Network Menu - Email](#)<sup>(252)</sup> section. When emails have been setup, if you ever forget your password in the future, you can simply click the **Forgot Password** button to email a new super password.

### Unlock Pattern

You can also set an Unlock Pattern similar to the ones used on mobile phones. When a pattern has been set you can use this to unlock the recorder rather than the password. To setup an Unlock Pattern choose Enable from the drop down list then click the pencil icon next to Draw.

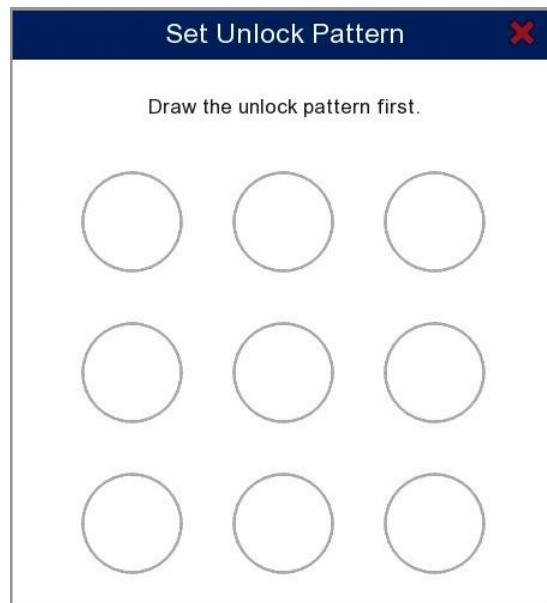

To set a new unlock pattern follow the steps below:

1. Left click and hold on the circle where you want your pattern to start.
2. Keeping the left mouse button pressed, draw your desired pattern through the other circles. Be aware, you can only select each circle once.
3. When finished release the left mouse button.
4. You will be asked to draw the same pattern again to confirm it. The window will close when successful.

To unlock the recorder using an unlock pattern simply re-draw the pattern in the same way.

If you ever forget your unlock pattern you can unlock the recorder using the admin password by clicking the **Password** button.

Once you have filled in all the required fields click **Apply** so save and exit.

## 3.2 Setup - Hard Drive Installation

If you are installing your own hard drives you will need to follow the steps below:

1. Power down the recorder and disconnect it from the power source.
2. Remove the screws holding the top cover to the rear panel and then remove the top cover.
3. Connect a SATA cable and hard drive power cable to the main board.
4. Secure the hard drive into place and then connect the SATA cable and hard drive power cable.
5. Replace the top cover, reconnect the power supply and start up the recorder.
6. Go into [Storage Menu - Disk](#)<sup>266</sup> sub-menu.
7. Tick the check box next to the new hard drive and then click the **Format HDD** button.



**Note:** For the best performance it is strongly recommended that you use a surveillance grade HDD from a reputable manufacturer.

### 3.3 Setup - Powering

Each Zip NVR is supplied with the relevant power supply. If you plan to power the NVR via another source the following table describes the power source required for each Zip NVR model:

Model	Connection	Voltage	Consumption
ZIP104	2.1mm DC Plug	12V DC	2A
ZIP108	2.1mm DC Plug	12V DC	5A
ZIP116	4 Pin Din Plug	12V DC	5A
ZIP204	4 Pin Din Plug	48V DC	1.2A
ZIP208	4 Pin Din Plug	48V DC	2A
ZIP216	IEC C13	240V AC	-
ZIP226	2x IEC C13	240V AC	-

**Warning:** *Using the wrong power supply may damage the equipment. We recommend that you use the PSU supplied with the NVR.*

## Operation

The Operation section shows how you can interact with the recorder using the IR remote control, USB mouse, on-screen keyboard and Live View menu.

### 4.1 Operation - IR Remote Control

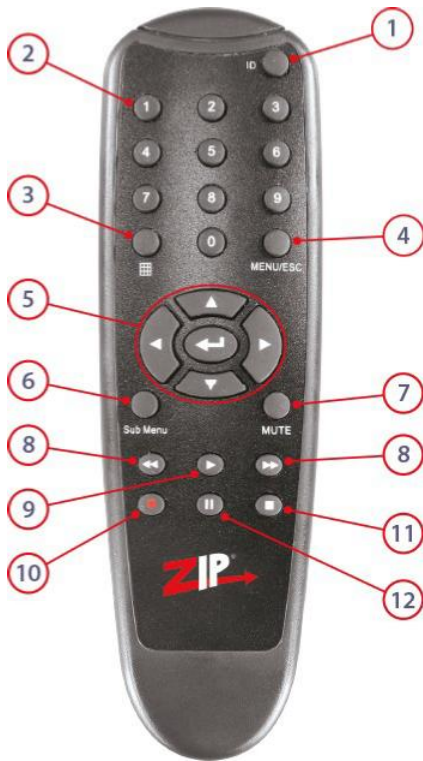

No.	Button	Name	Function / Description
1		ID	Control a specific recorder. Press 'ID' then 'Device ID' e.g.1 then 'Enter' <i>(Only used when multiple recorders are present)</i>
2		Numeric Buttons	Display selected channel full screen / Numeric input in a text field
3		Display Mode	Cycle to next display mode with each press. Single channel full screen / 2x2 / 3x3 / 4x4 / 5x5 / All channels <i>(Available display modes depends on recorder model)</i>
4		Menu / Escape	Display Main Menu / Exit current menu, screen or selection
5		Navigation / Enter	Directional keys for navigating through the recorder's menu system Enter - Confirms selection / Display Live View menu
6		sub-menu	Display Live View menu / Display Quick Setting toolbar
7		Mute	Mute / un-mute audio during live view and playback
8		Rewind / Fast Forward	Fast Forward / Rewind during playback
9		Play	Display playback screen / Resume video when paused
10		Record	Start recording of selected channel
11		Stop	Stop video playback / Stop recording on selected channel
12		Pause	Pause video during playback

## Controlling Multiple Recorders

If you are going to be controlling multiple recorders using the IR remote control you will need to set a different **Device ID** for each recorder so that you can choose the recorder you wish to control. If all recorders are set to the default ID of 1, when you press a button on the IR remote it will control every recorder within range at the same time.

To set the ID of the recorder go to the [System - General](#)<sup>(275)</sup> screen from the main menu and edit the **Device ID**.

With unique IDs set the IR remote can control a single recorder using the **ID** button. You must be in range of the recorder you want to control when you select the ID and any recorders with a different ID will now ignore the IR commands.

To choose which recorder you want to control press the **ID** button followed by the Device ID of the recorder (this can be a single digit e.g. 1) then press the **Enter** button. E.g. **ID > 1 > Enter** will control the recorder with Device ID of 1 and lock all others.

***Note:** Recorders with the Device ID set to 0 will never ignore IR commands even when you select a specific Device ID.*

## 4.2 Operation - USB Mouse Control



Name	Action	Function / Description
Left-Click	Single Click	Live view: display Quick Setting toolbar
		Menu: select and enter
	Click & Drag	Live view: drag channel
		Privacy Masking and Motion Detection: select target area
Right-Click	Single Click	Digital zoom-in: zoom in to target area
		Live view: show menu
Scroll-Wheel	Scrolling	Menu: exit current menu to upper level menu
		Scroll up / down through highlighted field / drop down list

You can change the mouse cursor speed and the cursor display timeout as explained in the [Output Configuration](#) <sup>(282)</sup> section.



### 4.3 Operation - Virtual Keyboard

You will see the virtual keyboard automatically on the screen anytime you need to enter data.



Key	Function / Description
	Delete character to left of the cursor
	Confirm input
	Switch keyboard to upper case letters and symbols
	Insert a space
	Move courser left / right

## 4.4 Operation - Live View Menu

The Live View menu, also called the Right Click Menu, gives you quick access to the Main Menu of the recorder, useful functions and realtime display settings.

In Live View mode, right click the mouse button on any channel to see the Live View Menu. The options available are listed below:



### Menu

Displays the main, easy to use "**Disc**" menu of the recorder. This is the main menu of the recorder. You can find out more in the [Disc Menu](#)<sup>(112)</sup> section.

### Single Screen

Switch to the single full screen by choosing a channel number from the break-out list.

### Multi Screen

Adjust the screen layout by choosing from one of the available camera configurations in the break-out list. The configurations available differ by recorder depending on the maximum number of cameras the recorder can accommodate.

## Auto Switch

Start and stop automatic switching between the camera images. You can set the auto switch layout and the amount of time the recorder displays each camera in the [General - Output Configuration](#) <sup>(282)</sup> section.

## Volume

Adjust the output audio volume of the recorder.

## Stream Switch

Switch between Main and Substream. Dropping the quality can be useful on slower networks.

## Realtime

Switch display performance to best suit your network. On slower networks you can drop the frame rate for more fluid viewing. You can choose Realtime (for fast networks), Balanced (for slower networks with slight lag) and Smooth (for slow networks with major lag).

## Playback

Enter the Playback interface. For more information on features and controls see the [Playback](#) <sup>(64)</sup> section.

## Shutdown

Allows you to shutdown the recorder, reboot the recorder or lock the screen to prevent unauthorised access.

## Manual Mode

Manually control camera recordings and alarm triggers as explained in the [Manual Mode](#) <sup>(32)</sup> section.

## Info

The Info screens a quick reference which display all of the important information for the recorder, camera channels and networks. The is explained in more detail in the [Info](#) <sup>(35)</sup> Section.

### 4.4.1 Operation - Live View Menu - Manual Mode

The **Manual Mode** screen allows you to manually trigger recording for individual channels and manually trigger alarm the alarm relay as described below.

#### Manual Record

This screen shows you which cameras are currently recording and allows you to manually start camera's recording.

Manual Record		Manual Alarm	
Channel Name	Manual Record	Record State	
Cam1		ON	
IP Cam1		ON	

**Channel Name:** Shows all channels with a camera connected.

**Manual Record:** Shows if the camera channel has been set to record manually or not. By default it will show a grey cross indicating that the is not currently recording from a manual trigger. To manually record a camera channel click the grey cross. The cross will turn to a blue tick to indicate that channel is now recording. To stop a channel manually recording simply click the blue tick again.

**Record State:** This tells you if the channel is currently recording automatically from a schedule or pre-set trigger such as an alarm or motion. **ON** lets you know that the channel is recording at this moment in time whereas **OFF** tells you that the channel is not currently recording footage.

#### Manual Alarm

As a handy automation solution you can manually open and close the alarm relay(s) on the recorder.

Manual Record		Manual Alarm	
Alarm Out	Manual Alarm		
Local->1			

**Alarm Out:** Indicates the alarm output on the recorder.

**Manual Alarm:** Allows you to open or close the relay for the alarm output.

### 4.4.2 Operation - Live View Menu - Info Screen

The Info screen can be used as a quick reference to hardware, software, camera and networking configurations. It's the fastest way to check settings or identify problems without having to log in to the recorder.

#### Information

The information screen shows all the key details of the recorder from model and serial number to firmware version and P2P ID.

Information	Channel Information	Record Info	Network State
Device ID	000001		
Device Name	ZDVR-S16		
Model No.	ZDVR-S16		
Serial ID	JPV00000		
Hardware Version	DM-404		
Software Version	V8.1.0-20200418		
IE Client Version	V2.0.0.409		
Video Format	PAL		
HDD Volume	2794GB		
IP Address	192.168.1.240		
IPv6 Address	fe80::3ab1:9eff:feb0:396 / 1		
Web	80,80		
Client	8240,8240		
MAC Address	38-B1-9E-B0-03-96		
Network State	connect fail		
P2P ID	ZIPA03773.JPV00000		

#### Channel Information

This screen shows the parameters and capabilities of each camera on the recorder.

You can see the Camera Number and Camera Name. The State tells you if the channel is enabled or disabled on the recorder. You can also see the Mainstream settings, Substream settings, Mobilestream settings plus Motion Detection and Privacy Zone abilities.

Information Channel Information Record Info Network State						
Camera	Camera Name	State	Mainstream	Substream	Mob	
Cam1	CH1	Enable	1280x1944, 14Fps, 2Mbps	704x 480, 5Fps, 512Kbps	No	
Cam2	CH2	Enable	1920x1080, 13Fps, 2Mbps	704x 576, 5Fps, 512Kbps	No	
Cam3	CH3	Enable	1280x1944, 14Fps, 2Mbps	704x 576, 5Fps, 512Kbps	No	
Cam4	CH4	Enable	1920x1080, 13Fps, 2Mbps	704x 576, 5Fps, 512Kbps	No	
Cam5	CH5	Enable	960x 576, 25Fps, 2Mbps	704x 576, 5Fps, 512Kbps	No	
Cam6	CH6	Enable	1920x1080, 13Fps, 2Mbps	704x 576, 5Fps, 512Kbps	No	
Cam7	CH7	Enable	960x 576, 25Fps, 2Mbps	704x 576, 5Fps, 512Kbps	No	
Cam8	CH8	Enable	1920x1080, 13Fps, 2Mbps	704x 576, 5Fps, 512Kbps	No	
Cam9	CH9	Enable	1920x1080, 13Fps, 2Mbps	704x 576, 5Fps, 512Kbps	No	
Cam10	CH10	Enable	1920x1080, 13Fps, 2Mbps	704x 576, 5Fps, 512Kbps	No	
Cam11	CH11	Enable	1920x1080, 13Fps, 2Mbps	704x 576, 5Fps, 512Kbps	No	
Cam12	CH12	Enable	1920x1080, 13Fps, 2Mbps	704x 576, 5Fps, 512Kbps	No	
Cam13	CH13	Enable	1920x1080, 13Fps, 2Mbps	704x 576, 5Fps, 512Kbps	No	
Cam14	CH14	Enable	1920x1080, 13Fps, 2Mbps	704x 576, 5Fps, 512Kbps	No	

### Record Info

A nice concise screen which shows the recording settings for each camera. A fast way to check what's recording and at what quality.

You can see information on the Record State to check if the channel is currently recording, the Record Switch which shows if the channel has permission to record, the Stream Type, Resolution, FPS and Bitrate.

Information Channel Information Record Info Network State <span style="float: right;">✖</span>						
Camera	Record State	Record Switch	Stream Type	Resolution	FPS	Bitrate
Cam1	ON	Enable	DualStream	1280x1944   704x480	14Fps   5Fps	2Mbps   51
Cam2	ON	Enable	DualStream	1280x1944   704x480	14Fps   5Fps	2Mbps   51
Cam3	ON	Enable	DualStream	1280x1944   704x480	14Fps   5Fps	2Mbps   51
Cam4	ON	Enable	DualStream	1280x1944   704x480	14Fps   5Fps	2Mbps   51
Cam5	ON	Enable	DualStream	1280x1944   704x480	14Fps   5Fps	2Mbps   51
Cam6	ON	Enable	DualStream	1280x1944   704x480	14Fps   5Fps	2Mbps   51
Cam7	ON	Enable	DualStream	1280x1944   704x480	14Fps   5Fps	2Mbps   51
Cam8	ON	Enable	DualStream	1280x1944   704x480	14Fps   5Fps	2Mbps   51
Cam9	ON	Enable	DualStream	1280x1944   704x480	14Fps   5Fps	2Mbps   51
Cam10	ON	Enable	DualStream	1280x1944   704x480	14Fps   5Fps	2Mbps   51
Cam11	ON	Enable	DualStream	1280x1944   704x480	14Fps   5Fps	2Mbps   51
Cam12	ON	Enable	DualStream	1280x1944   704x480	14Fps   5Fps	2Mbps   51
Cam13	ON	Enable	DualStream	1280x1944   704x480	14Fps   5Fps	2Mbps   51
Cam14	ON	Enable	DualStream	1280x1944   704x480	14Fps   5Fps	2Mbps   51

### Network State

A useful screen for networked recorders as it has all your network settings in one place. Great for troubleshooting as you can quickly check if all your ports and addresses are correct.

Information Channel Information Record Info Network State <span style="float: right;">✖</span>		
Attribute	Value	
WAN		
IP Address	192.168.1.240	
Subnet Mask	255.255.255.0	
Gateway	192.168.1.254	
MAC Address	38-B1-9E-B0-03-96	
IPv6 Address	fe80::3ab1:9eff:feb0:396 / 1	
IPv6 Gateway	ff00::/8	
DHCP	Disable	
DNS1	192.168.1.254	
DNS2	8.8.8.8	
PPPoE	Disable	
UPNP	Disable	
Port		
Web	80,80,Inactive,Disable	
Client	8240,8240,Inactive,Disable	
RTSP	1240,1240,Inactive,Disable	
Https	443,443,Inactive,Disable	
Total Band Width:	32Mbps	
Used Band Width:	5Mbps	



## 4.5 Operation - Live View Toolbar

The Live View Tool Bar is displayed by clicking the left mouse button when the mouse pointer is over the camera image of the channel you wish to control. The tool bar is displayed in the near the bottom of the screen during single channel view and directly above or below the selected camera's image during multi channel view.



Icon	Function
	<b>Manual Record</b> - Click to start manually recording the channel. Recording can then be viewed in Playback.
	<b>Manual Capture</b> - Click to take a snapshot of the cameras image. Captured images can then be viewed in Playback - Capture.
	<b>Instant Playback</b> - Plays recordings from the last 5 minutes.
	<b>PTZ Controls</b> - Displays the PTZ and UTC controls. For more information see the <a href="#">PTZ Controls</a> <sup>(40)</sup> section.
	<b>Digital Zoom</b> - Click to activate digital zoom. For more information see the <a href="#">Digital Zoom</a> <sup>(46)</sup> section.
	<b>Colour Settings</b> - Opens the colour settings window. For more information see the <a href="#">Colour Settings</a> <sup>(47)</sup> section.
	<b>Add Customised Tag</b> - Click to add a custom tag to the recorded footage. For more information see the <a href="#">Add Customised Tag</a> <sup>(48)</sup> section.
	<b>Handle</b> - Click and drag to move the Tool Bar around the screen.

### **4.5.1 Operation - Live View Toolbar - PTZ Controls**

The PTZ Control screen allows you to adjust the zoom, focus and menu settings of compatible cameras from the recorder.

You can also control the movement of PTZ cameras, call presets or create new ones.

#### 4.5.1.1 Operation - Live View Toolbar - PTZ Controls - PTZ

In the PTZ control screen you can dictate the movement, zoom, focus and iris of compatible PTZ cameras.



#### Camera Selection

You can select which camera you want to control from the **Camera** drop down list.

### PTZ Controls Explained

The buttons in the left hand panel are used to control the camera's movement and configuring the camera's menu settings as explained below. The options available will vary depending on the capabilities of the camera itself.

Icon/Control	Name	Function
	<b>Directions</b>	The direction buttons are used to control the left/right and up/down movement of the PTZ camera. The direction buttons are also used for navigating the camera's menu system.
	<b>Menu / Confirm</b>	On compatible cameras the Centre button is used to display the camera's menu system and to confirm selections once in the menu system. <i>Note: On some PTZs you may have to call a certain preset to display the menu system. For more information see the <a href="#">Preset</a><sup>(43)</sup> section.</i>
	<b>Speed</b>	The Speed slider dictates how fast the camera moves around when you are using the Direction buttons. You can set the speed anywhere from 1 to 100 with 100 being the fastest.
	<b>Step</b>	The Step number determines how much of an affect the Focus buttons have. A step number of 1 will only make minute adjustments allowing for fine tuning where as a step number of 20 will make larger more noticeable adjustments.
	<b>Zoom</b>	The Zoom buttons allow you to manually adjust the camera's zoom in and out.
	<b>Focus</b>	With the Focus buttons you can manually adjust the camera's focus.
	<b>Iris</b>	Iris + and - allow you to open or close the camera's iris so you can control the amount of light hitting the image sensor making the image brighter or darker.
	<b>Auto Focus</b>	The Auto Focus button will automatically focus the camera's image.
	<b>Restore</b>	Clicking the Restore button will adjust the zoom back to the previous focal length. The camera's image can then be re-focused using the Auto Focus button.

#### 4.5.1.2 Operation - Live View Toolbar - PTZ Controls - Preset

The Preset screen is where you can create presets, call presets and manage cruises.



#### Camera Selection

You can select which camera you want to control from the **Camera** drop down list.

### Preset Controls Explained

The buttons in the left hand panel are used to position the camera when saving preset locations, creating presets, calling presets, removing presets and starting/stopping cruises. The options available and functions may vary depending on the capabilities of the PTZ itself.







Icon/Control	Name	Function
	<b>Directions</b>	The direction buttons are used to control the left/right and up/down movement of the PTZ camera when creating a preset position.
	<b>Auto Cruise</b>	Clicking the centre button will start the the PTZ rotating continuously until stopped. To stop the rotation either click the centre button again or click on of the direction buttons.
No. <input type="text" value="001"/>	<b>Preset Number</b>	This is where you can enter a preset number you want to call or the number you want to assign to a new preset for the current camera position.
Time <input type="text" value="003"/>	<b>Dwell Time</b>	When creating a new preset position the Dwell Time determines how long the PTZ will stay in that position during a cruise.
	<b>Set Preset</b>	When you have positioned the camera, assigned a Preset Number and set the Dwell Time you can click the Set Preset button. This will create a preset in the Preset List for this configuration.
	<b>Clear Preset</b>	After setting a preset the number in the Preset Number field will increase by 1. Clicking the Clear Preset button once will reduce the Preset Number to the last used.  Each further click of the Clear Preset button will delete the last preset from the Preset List.
	<b>Go To</b>	Clicking the Go To button will action the preset number currently showing in the Preset Number field. This can be a pre-defined preset specific to the camera or a preset from the Preset List.
<input type="button" value="Start Cruise"/> <input type="button" value="Stop Cruise"/>	<b>Start Cruise / Stop Cruise</b>	The Start Cruise button will start to cycle through the saved preset positions in the Preset List. The PTZ will stay in each position for the defined Dwell Time then move on to the next position. The cruise will repeat until you click Stop Cruise.
<input type="button" value="Save"/>	<b>Save</b>	Click Save to save the current Preset List. Any new presets you create will be lost when you exit the PTZ Controls screen if you haven't clicked Save.

### Total Presets

The Total number shows the total number of presets currently in Preset List.

## Preset List

The Preset List displays all of the previously set and saved presets in numeric order.

No.	Time	Clear	GO TO
1	10		
2	15		
3	15		

**No.:** This column shows the Preset Number assigned to the previously saved camera position.

**Time:** The Time column shows how long the camera will stay in the preset position before moving on to the next position during a cruise.

**Clear:** The Clear button allows you to delete the a preset from the Preset List.

**Go To:** Clicking the arrow icon in the Go To column will move the camera to the previously saved position.



## 4.5.2 Operation - Live View Toolbar - Digital Zoom

When you click the digital zoom icon you will notice a small window appears in the bottom right corner of the screen repeating the camera's image. If you are viewing a multi-channel layout the selected channel will be displayed full screen. As you zoom in and move around the main image, this smaller window retains the full camera image. A rectangle will appear inside the smaller window to show what portion of the main image you are currently viewing.



**Zooming:** Use the scroll wheel on the mouse to zoom in and out of the main camera image.

**Moving Around:** To move around the camera's image when zoomed in you can either click and drag the main image or click and drag the rectangle inside the smaller image.

**Reposition Smaller Image:** To reposition the smaller image just click (outside the rectangle) and drag it where you wish.

**Exit Digital Zoom:** To return to Live View click the right mouse button.



### 4.5.3 Operation - Live View Toolbar - Colour Settings

When you click the Colour Settings icon the following window will be displayed.

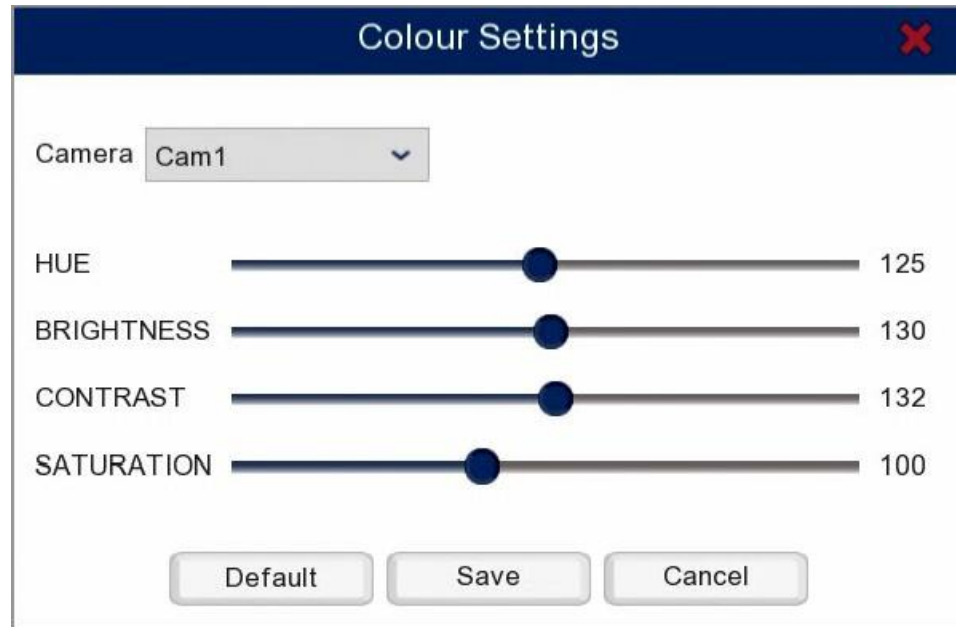

**Camera:** The camera drop down list allows you to choose which camera you want to configure the colour setting for. You can have different settings for each camera to get the best image possible on every channel. By default it will open on the camera you had selected when you chose Colour Settings.

**Sliders:** You can click and drag the sliders to adjust the Hue, Brightness, Contrast and Saturation for the selected camera.

**Default:** Allows you to restore the default colour settings to the selected camera.

**Save:** Click Save to confirm and store any changes.

**Cancel:** Click Cancel to exit the Colour Settings screen without saving changes.

**Exit Colour Settings:** To return to Live View click the right mouse button.

#### 4.5.4 Operation - Live View Toolbar - Add Customised Tag

When you see an incident happen in real time during Live View, you can click Add Customised Tag to flag the incident in the recorded footage and then quickly find it again at a later stage as shown in the [Playback - Tag section](#)<sup>(93)</sup>. The tag is added to the selected camera's recorded footage pointing back to the time it was created. When you click Add Customised Tag you will see the following window.



Camera	Cam1
Tag Time	2020/11/13 11:58:58
Tag Name	<input type="text" value="Tag"/>

Save Cancel

**Camera:** States which camera's footage the tag will be added to.

**Tag Time:** States the time and date at which the tag will be created.

**Tag Name:** This is the name of the incident which will appear in the tag list in the playback screen so call it something useful such as "Theft". Click inside the field to edit the name of the tag. The name can be up to 20 characters long and can include alpha numeric and special characters.

**Save:** Click save to confirm and store your tag.

**Cancel:** Click Cancel to exit the Add Tag screen without saving changes.

## Smart Setup

When the recorder boots up the Smart Setup wizard will be displayed. This easy to use wizard guides you through the configuration of the important settings on the recorder to get you up and running. From the wizard you can Configure Network Settings, Time and Date, Disk Drives, Display Resolution and the Zip Vision Mobile Apps.



To disable the Smart Setup Wizard so that it does not show during startup, check the box that says "**Don't show this window next time**" on the **Summary** screen.

## 5.1 Smart Setup - Network

Setting your recorder up on a network will allow you to remotely monitor the recorder from a PC, tablet or mobile phone once either [P2P setup](#)<sup>(58)</sup> or [port forwarding](#)<sup>(247)</sup> has been configured. You can also connect to IP cameras on the same network.

Your recorder should be plugged in to a network or router before you make changes in this section. The smart setup wizard allows you to configure a local connection, DNS, ports, PPPoE and 3G dongles. These settings can be set at a later stage as explained in the [Network Menu - Genreal](#)<sup>(243)</sup> section.

### Local Connection Settings

Local Connection	
DHCP	<input checked="" type="checkbox"/>
IP Address	192.168.001.100
Subnet Mask	255.255.255.000
Gateway	192.168.001.001
IPv6 Address	2000:0:0:0:0:0:1 / 128
IPv6 Gateway	2000:0:0:0:0:0:1

Selecting **DHCP** the easiest way to complete this section as it will allow the network to automatically set the IP address, subnet mask, gateway, IPv6 address and IPv6 gateway.

Once the network parameters have been set, deselect DHCP to lock in the credentials and to prevent the network re-assigning them in the future. These credentials are what the software and apps use when looking for the recorder over the internet so if they change the software wont be able to find the recorder.

If you know what credentials you wish to use, such as a static IP address, you can de-select DHCP and enter them manually.

### DNS Settings

DNS	
DNS1	192.168.001.254
DNS2	008.008.008.008

Selecting **DHCP** under **Local Connection** will automatically assign the DNS addresses from the router. This is usually the service provider's DNS address. DNS2 is automatically assigned as 8.8.8.8 which is Google's primary DNS address.

If you wish to set the DNS addresses manually you can de-select DHCP under Local Connection.

## Port Settings

Port							
	Service	Protocol	Internal Port	External Port	UPNP Status	Mapping Strategy	UPNP
1	Web	TCP	00080	00080	Inactive	Auto	<input type="checkbox"/>
2	Client	TCP	08240	08240	Inactive	Auto	<input type="checkbox"/>
3	RTSP	TCP	01240	01240	Inactive	Auto	<input type="checkbox"/>
4	Https	TCP	00443	00443	Inactive	Auto	<input type="checkbox"/>

The easiest way to set up a recorder for remote viewing is to use the P2P feature where you scan a QR using the mobile app and the recorder's settings are configured for you. You can find out more about this in the [P2P section](#)<sup>58</sup>.

Port forwarding, to access your Zip recorder over the internet, requires setting up your router. This can be done by accessing your router's web interface via a browser and setting the port forwarding or, for those routers that support it, using UPnP (universal plug and play) which sets the router automatically. Just select UPNP on each row and the router will assign the ports for you. If you need to set the ports manually the default ports are listed below:

- **Web (HTTP)** = 00080
- **Client** = 08240
- **RTSP** = 01240
- **HTTPS** = 00544

## PPPoE Settings

PPPoE	
Enable PPPoE	<input type="checkbox"/>
User	<input type="text"/>
Password	<input type="password"/> <input type="checkbox"/> Show Password

If you have a dedicated line for the recorder you can bypass the router and connect direct to you service provider using the the username and password they have assigned to you.

### 3G Settings

3G	
Enable 3G	<input type="checkbox"/>
APN	3gnet
Dial Code	*99#
User	card
Password	•••• <input type="checkbox"/> Show Password

For use on future firmware.

## 5.2 Smart Setup - Date & Time

It's important to set the time and date correctly for multiple reasons. As the time and date is overlaid onto recorded footage, having the wrong time and date set would mean you couldn't accurately say when an event took place. Schedules wouldn't trigger at the required time which could lead to events not being recorded. It could also lead to support issues as some support is date sensitive.

### Date/Time

Date	10/11/2020 
Time	09:47:39
Date Format	DD/MM/YYYY 
Time Format	24Hour 
Time Zone	GMT 

If your recorder has an internet connection via a network/router you can set the time and date automatically as described in the NTP section below. Alternatively you can set the time and date manually as described here.

**Date:** To set the date just click on the calendar icon to open the calendar view. You can then choose the year and month then click on a date to select it.

**Time:** Click on the time to adjust it. The [virtual keyboard](#)<sup>(31)</sup> will be displayed allowing you to set the time.

**Date Format:** You have 3 options to choose from when selecting the date format:

- MM/DD/YYYY
- YYYY-MM-DD
- DD/MM/YY

*(DD = Day / MM = Month / YYYY = Year)*

**Time Format:** You can set the time format to a 24 hour clock or a 12 hour clock.

**Time Zone:** You can also change the time zone if you are using the recorder outside of the UK. As standard the recorder will be set to GMT.

### NTP (Network Time Protocol)

Enable NTP	<input checked="" type="checkbox"/>
Server Address	pool.ntp.org 
<input type="button" value="Update Now"/>	

If your recorder can connect to the internet via a network or router, NTP will set the time and date automatically for you. By default NTP is enabled so if your recorder is already networked you will notice the time and date is already correct.

You can disable NTP or change the server if you wish.

### DST (Daylight Saving Time)

Enable DST	<input checked="" type="checkbox"/>			
Time Offset	1Hour			
DST Mode	Week			
Start Time	Mar.	The last	Sun.	01:00:00
End Time	Oct.	The last	Sun.	02:00:00

DST is enabled by default for use in the UK. You can disable DST or adjust the configuration here. If you need to re-configure DST at a later date you can do that in the [menu](#).

**Time Offset:** Here you can set by much the time changes at the start and end of DST.

**DST Mode:** You can set DST mode to start and end by Week or by Date. Week is selected by default as it allows you to set a none specific date such as the last Sunday of March. Selecting Date allows you to specify a specific date.

**Start Time:** This is the time and date at which the clocks go forward.

**End Time:** This is the time and date at which the clocks go back.



## 5.3 Smart Setup - Disk Drives

In the Disk screen you can format drives and also set if and when the recorder overwrites old footage.

No.	Serial No.	Model	Firmware	State	Free/To
<input type="checkbox"/> 1*	29H3E8JFS	TOSHIBA DT01ACA100	MS20A750	Normal	618GB/93

Overwrite: Auto

### Formatting A Hard Drive

If the recorder was purchased with a hard disk drive(s) already installed these have already been formatted for you. When you are installing you own drives in to the recorder, it will need to be formatted before use.

Select the hard drive which you want to format and then click the **Format HDD** button.

### Overwriting Footage

The Overwrite drop down selection lets you set when to overwrite the old recordings on the hard drive.

**Auto** is selected by default. When set to Auto the recorder will automatically start to overwrite old footage once the hard drive is full.

You can tell the recorder begin overwriting old footage after a specified amount of time. For example, if you choose the option **7 Days** then only the last 7 days recordings are kept on the HDD. After 7 days the recorder will start overwriting the old footage.

To prevent overwriting of any old recordings, select **Off**. If you choose this option, please check the hard drive status regularly to make sure the hard drive is not full. With Off selected, once the hard drive is full the recorder will stop recording and start beeping to alert you to the full hard drive.

## 5.4 Smart Setup - Resolution

You can quickly set the output resolution of the recorder to best suit your monitor from the Smart Setup wizard.

Output Resolution	1080P(1920x1080) ▼
<input type="button" value="Apply"/>	

The output resolution options are listed below:

- 1024 x 768
- 1280 x 1024
- 1440 x 900
- 720P (1280 x 720)
- 1080P (1920 x 1080)

## 5.5 Smart Setup - Mobile Settings

This screen displays the ports and addresses required when connecting to the recorder from the Zip Vision PC client software or the Zip Vision mobile apps.

P2P ID	
P2P ID	ZIPA03453JPI00000
Local Connection	
IP Address	192.168.1.100
Subnet Mask	255.255.255.0
Port	
Web	80
Client	8240



### P2P ID

The P2P ID or QR code can be used when adding the recorder to the PC software or mobile app without the need for port forwarding as described in the [P2P section](#) <sup>(58)</sup>.

### Local Connection

This is the IP Address and Subnet Mask of the recorder.

## Port

These are the ports on the router used by the recorder defined during [Network Configuration](#)<sup>50</sup> in the Smart Setup Wizard.

**Note:** *When adding devices to the PC software or mobile apps you don't need to worry about these.*

## 5.6 Smart Setup - P2P

The easiest way to configure your recorder for remote viewing is to use the P2P feature. This can be done after you have configured the [Local Connection Settings](#)<sup>50</sup>.

P2P allows access to the recorder without the need for port forwarding or DDNS. P2P uses a server to make the initial connection between the recorder and the software or mobile app. Once connected the server is not used. When connecting with P2P the P2P ID is entered into the Zip Vision PC client software or mobile app. As you can not enter the P2P ID into a web browser P2P cannot be used with internet explorer.

When adding a device in the Zip Vision mobile app you are given the option to either scan the QR code or enter the P2P ID manually.

When adding a device in the Zip Vision PC software you will need to enter the P2P ID manually.

The P2P ID address and QR code can be found in the [Mobile Settings](#)<sup>56</sup> section of the Startup Wizard or from the **Info** screen in the Live View menu (shown below).

Information		Channel Information	Record Info	Network State
Device Name	ZDVR-S16			
Model No.	ZDVR-S16			
Serial ID	JPV00000			
Hardware Version	DM-404			
Software Version	V8.1.0-20200418			
IE Client Version	V2.0.0.409			
Video Format	PAL			
HDD Volume	2794GB			
IP Address	192.168.1.240			
IPv6 Address	fe80::3ab1:9eff:feb0:396 / 1			
Web	80,80			
Client	8240,8240			
MAC Address	38-B1-9E-B0-03-96			
Network State	connect fail			
P2P ID	ZIPA03773JPV00000			

**Note:** P2P cannot be used with internet explorer as you can not enter the P2P ID into a web browser.

## Live View

Live view displays the video from each camera in real time. After signing on to your recorder it will automatically enter Live View mode when.



### 6.1 Live View - Screen Display

In Live View you can view your cameras as a single channel or multi-channel display. If you double click on a channel whilst in a multi-channel display it will open that channel in a full screen display, if you double click again it will revert back to the multi-channel display.



### Display Modes

You can set the display mode from the Live View (right click) menu. This dictates which channel is shown or how multiple channels are displayed on screen.



**Single Screen:** Displays a list of all channels on the recorder. Selecting a channel from the list will display that camera full screen.

**Multi Screen:** Displays a list of all possible multi channel layout configurations. The configurations available differ based on the size of the recorder.

For more information on the functions of the Live View menu in the [Operation](#)<sup>32</sup> section.

## 6.2 Live View - Status

### Status Icons

In Live View mode there are icons at the bottom of each camera image showing the current status of the camera and/or the recorder as described below:

Icon	Channel Status
<b>R</b>	The camera channel is recording
<b>M</b>	The camera has detected motion but the channel is not recording
<b>M</b>	The camera has detected motion and is the channel now recording
<b>I</b>	The I/O alarm external sensor has been triggered but the channel is not recording
<b>I</b>	The I/O alarm external sensor has been triggered and is the channel now recording
<b>S</b>	The Smart Option sensor has been triggered but the channel is not recording
<b>S</b>	The Smart Option sensor has been triggered and is the channel now recording
<b>H</b>	The recorder cannot detect a HDD or the HDD is not formatted

### Channel Status

Sometimes you may see a message instead of the camera's image. The possible messages and their meanings are shown below:

- **Video Loss:** Displays when connection to the camera has been lost.
- **Off-Line:** The previously added IP camera is off line or disconnected.
- **No Camera:** IP camera has not been connected to the recorder.
- **No HDD:** There is no hard drive installed or the recorder can not detect the hard drive.



### 6.3 Live View - Camera Position

When Live View is set to a multi channel display mode it is possible to switch the positions of the cameras to get the layout .

For example, when viewing cameras in a 2x2 display mode Channel 1 is automatically shown in the top left corner of the screen and Channel 2 is shown in the top right corner of the screen.

To switch the two channels simply click and drag one of the camera images onto the camera image you want it to swap positions with as shown below.





## 6.4 Live View - Camera Overlays

Each channel can display the date/time and a camera name of up to 40 characters as an overlay on the camera's image.

These can be enable/disabled, edited and re-positioned from the **Live** sub-menu under the **Video** menu. Just go to **Menu > Video > Live**. You can see how to do this in the [Video Menu - Live](#)<sup>(147)</sup> section.

### IP Camera Channel Name

You can also rename the channel number with a new name up to 8 characters long. For example instead of IP CAM1 it could be OFFICE 1. To see how to set this up see the [Video - IP Channels](#)<sup>(118)</sup> section.

## Playback

The Playback screen is your hub for reviewing, interrogating and backing up footage.

The Playback screen can be accessed in 2 ways. The first method is to press the **PLAY/PAUSE** button on the front panel of the recorder. This will take you to the Playback screen with no search results. By default it will open on today's date but with no cameras selected and no footage playing.

Alternatively you can select Playback from the Live View menu. This will take you to the Playback screen with all live cameras selected. Again by default it will start from today's date and it will automatically start playing the earliest recorded footage.

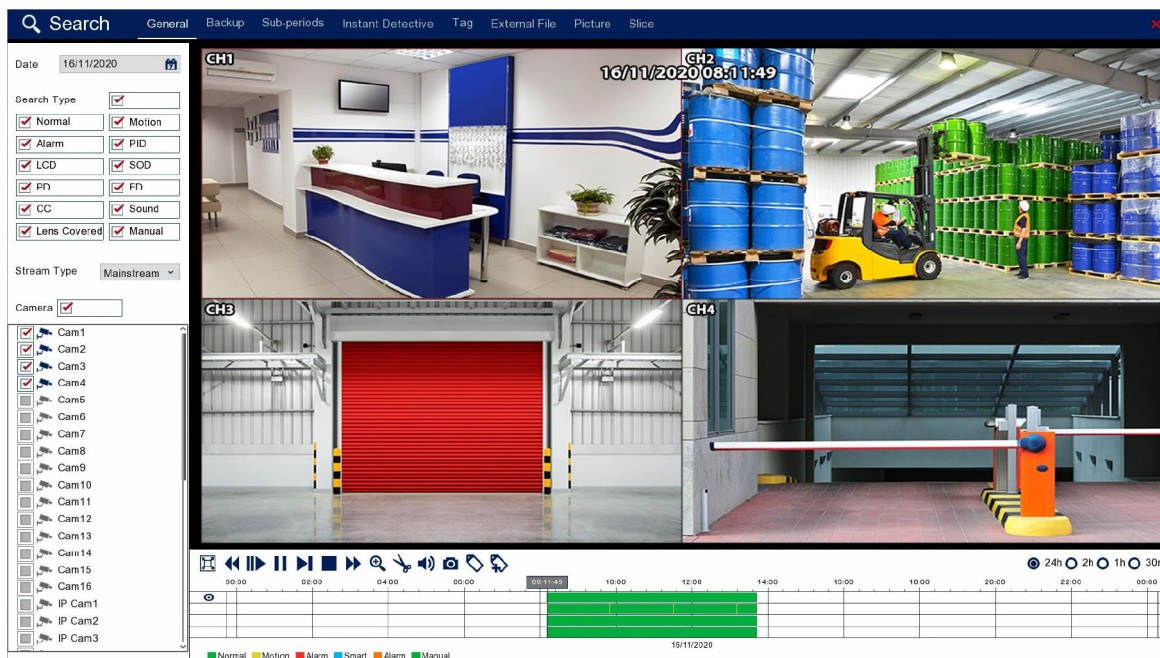

You have 8 options inside the Playback screen:

- [General](#)<sup>(72)</sup> - for traditional footage playback
- [Backup](#)<sup>(75)</sup> - for backing up recorded footage
- [Sub-periods](#)<sup>(83)</sup> - Plays consecutive time periods from one camera at the same time in a split screen display
- [Instant Detective](#)<sup>(86)</sup> - Lets you retrospectively interrogate footage.
- [Tag](#)<sup>(93)</sup> - Allows you to find footage using custom tags
- [External File](#)<sup>(99)</sup> - Playback footage from a storage device
- [Picture](#)<sup>(101)</sup> - Lets you search for and view captured snapshots.
- [Slice](#)<sup>(107)</sup> - A great tool for finding an event by narrowing down using thumbnail snapshots.

## 7.1 Playback Toolbar Explained

This is the Playback toolbar. You will see a variation of this toolbar in many of the playback screens. It has many of the same features as toolbars you find on mobile apps or PC media players. You will also find some useful tools specific to our Zip CCTV recorders as described below.

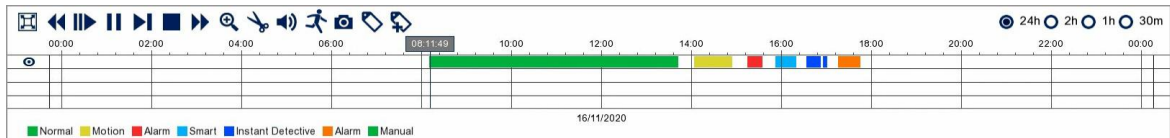

### Playback Controls

Icon	Name	Function
	<b>Return</b>	Click Play to return to the <a href="#">Backup</a> <sup>75</sup> screen.
	<b>Full Screen</b>	Enter and exit full screen playback.
	<b>Rewind</b>	Rewind footage 2x, 4x, 8x or 16x normal speed. The current speed is displayed in the top right corner of the screen.
	<b>Slow Play</b>	Play footage in slow motion at 1/2, 1/4, 1/8 and 1/16 normal speed. The current speed is displayed in the top right corner of the screen.
	<b>Play</b>	Play selected recording / Resume playback.
	<b>Pause</b>	Pause playback.
	<b>Step / Next</b>	Progress the footage forward one frame at a time with each press during video playback. Go to next image during snapshot playback.
	<b>Previous</b>	Go back to previous image during snapshot playback.
	<b>Stop</b>	Stop playback.
	<b>Fast Forward</b>	Fast forward footage 2x, 4x, 8x or 16x normal speed. The current speed is displayed in the top right corner of the screen.







### Advanced Controls

Icon	Name	Function
	<b>Zoom</b>	Click to activate digital zoom and control as described in <a href="#">Digital Zoom</a> <sup>(68)</sup> .
	<b>Snipping Tool</b>	Snip out and backup a section of footage. Click to start snipping. For more information see <a href="#">Snipping Tool</a> <sup>(69)</sup> .
	<b>Back-up</b>	Only shown when you have started a snipping. Click to end and save snipping. You can save as Qzip, AVI or MP4 video format.
	<b>Volume</b>	Click to display the audio volume slider. Move the slider up or down to adjust the playback volume.
	<b>Mute</b>	Only shown when the volume is set to 0. Click to display the audio volume slider. Move the slider up to adjust the playback volume.
	<b>Instant Detective</b>	Only shown in the Instant Detective screen. Click to open the configuration window. For more information see <a href="#">Instant Detective</a> <sup>(86)</sup> .
	<b>Manual Capture</b>	Click to instantly capture and backup a snapshot for the selected channel. For more information on saving the snapshot see <a href="#">Backup</a> <sup>(317)</sup> .
	<b>Default Tag</b>	Click to add a default tag to the recorded footage so that you can easily find events again when required. For more information see <a href="#">Tags</a> <sup>(71)</sup> .
	<b>Customised Tag</b>	Click to add a custom tag to the recorded footage so that you can easily find events again when required. For more information see <a href="#">Tags</a> <sup>(71)</sup> .

### Timeline Controls

Icon	Name	Function
	<b>24 Hour Timeline</b>	Select to display a 24 hour timeline during playback.
	<b>2 Hour Timeline</b>	Select to display a 2 hour timeline during playback.
	<b>1 Hour Timeline</b>	Select to display a 1 hour timeline during playback.
	<b>30 Minute Timeline</b>	Select to display a 30 minute timeline during playback.

### Timeline Key

Icon	Name	Function
	<b>Normal / Manual</b>	Shows on the timeline for footage which was captured normally from a <a href="#">schedule</a> <sup>(209)</sup> or manual pressing/clicking record.
	<b>Motion</b>	Shows on the timeline for footage which was captured when <a href="#">motion detection</a> <sup>(159)</sup> was triggered.
	<b>Alarm</b>	Shows on the timeline for footage which was captured as the result of an <a href="#">alarm</a> <sup>(223)</sup> trigger.
	<b>Smart</b>	Shows on the timeline for footage which was captured as the result of a Smart Settings trigger. For more information see <a href="#">Video - Smart</a> <sup>(163)</sup> .
	<b>Instant Detective</b>	Shows on the timeline for footage which was retrieved from an <a href="#">Instant Detective</a> <sup>(86)</sup> interrogation.
	<b>Cross Counting</b>	Shows on the timeline for footage which was captured as the result of a <a href="#">Cross Counting</a> <sup>(186)</sup> trigger.

### Full Screen Playback Controls

To display the playback controls during full screen playback, move the mouse cursor to the bottom of the screen. The playback controls and time-line will then pop up along the bottom edge of the screen.

### 7.1.1 Playback Toolbar - Digital Zoom

When you click the digital zoom icon you will notice a small window appears in the bottom right corner of the screen repeating the camera's image. If you are viewing a multi-channel layout the selected channel will be displayed full screen. As you zoom in and move around the main image, this smaller window retains the full camera image. A rectangle will appear inside the smaller window to show what portion of the main image you are currently viewing.



**Zooming:** Use the scroll wheel on the mouse to zoom in and out of the main camera image.

**Moving Around:** To move around the camera's image when zoomed in you can either click and drag the main image or click and drag the rectangle inside the smaller image.

**Reposition Smaller Image:** To reposition the smaller image just click (outside the rectangle) and drag it where you wish.

**Exit Digital Zoom:** To return to Live View click the right mouse button.

### 7.1.2 Playback Toolbar - Snipping Tool

 The Snipping Tool allows you to "snip" out and back-up a small segment from your recorded footage. It's a quick and easy way of backing up the precise footage you need without having to save a large file or having to remember start and end times.

Snippings are saved onto a connected USB device. We recommend connecting your USB backup device to the recorder before you start your snipping however you can do this later.

There are 2 ways in which you can decide what footage is snipped and saved as described below:

#### 2 Minute Clip

To backup a short 2 minute clip just click the **Snipping Tool** button during playback at the point you want the 2 minute clip to start. You will see a pale section appear on the timeline showing the period the 2 minute clip will cover.

You can save a video clip from multiple cameras covering the same 2 minute period by checking the box for each channel on the left of the timeline. In the example below only channel 1 is selected.



To save the clip click the **Backup** button. This will display the **Backup Type** window as explained below.

#### Custom Length Clip

You can also save a snipping by selecting the exact period of time you want to cover. To do this click the **Snipping Tool** during playback. You can then click and drag on the timeline from where you want the clipping to start to where you want it to end.

You can save a video clip from multiple cameras covering the same period of time by dragging over multiple channels on the timeline as shown below.





To save the clip click the **Backup** button. This will display the **Backup Type** window as explained below.

### Saving Video Clips

When you are ready to save the snipping click the **Backup** button on the toolbar. The following window will be displayed showing the size of the file, which camera's footage is being saved and the start and end time.

You also have 3 options for the file format. Qzip is secure, encrypted file format which can only be played back using **Zippy player** which can be downloaded from [SoftCCTV.com](http://SoftCCTV.com). You can also save the clipping as an AVI or MP4 video file which can be viewed on most media devices.



When you have made your selection click **Save**. A **Backup** window will display where you can choose and manage you backup device. For more information see the [Backup](#)<sup>317</sup> section.



### 7.1.3 Playback Toolbar - Tags

If you are viewing footage in Playback and you see an incident occur, you can add a Tag to flag the incident and then quickly find it again at a later stage as shown in the [Playback - Tag section](#)<sup>93</sup>.

There are 2 types of tags you can add to your footage, a Default Tag or a Customised Tag as explained below.

#### Default Tag

A default tag is the quickest way of adding a flag to the recorded footage with just one click. However, all of tags are simply called "Tag" so this could get confusing if you create a large number.

#### Customised Tag

Adding a customised tag allows you to give the tag a memorable name so you can quickly find the right tag without having to check the footage. When you click **Customised Tag** the following window will be displayed.



Camera	Cam1
Tag Time	2020/11/13 11:58:58
Tag Name	<input type="text" value="Tag"/>

Save Cancel

**Camera:** States which camera's footage the tag will be added to.

**Tag Time:** States the time and date at which the tag will be created.

**Tag Name:** This is the name of the incident which will appear in the tag list in the playback screen so call it something useful such as "Theft". Click inside the field to edit the name of the tag. The name can be up to 20 characters long and can include alpha numeric and special characters.

**Save:** Click save to confirm and store your tag.

**Cancel:** Click Cancel to exit the Add Tag screen without saving changes.

## 7.2 Playback - General

When you enter the Playback screen it will open on the General playback tab. This is the traditional playback screen you will be used to seeing if you have used CCTV recorders before. You can use the panel on the left hand side of the screen to search for footage by date, type and camera as explained below.

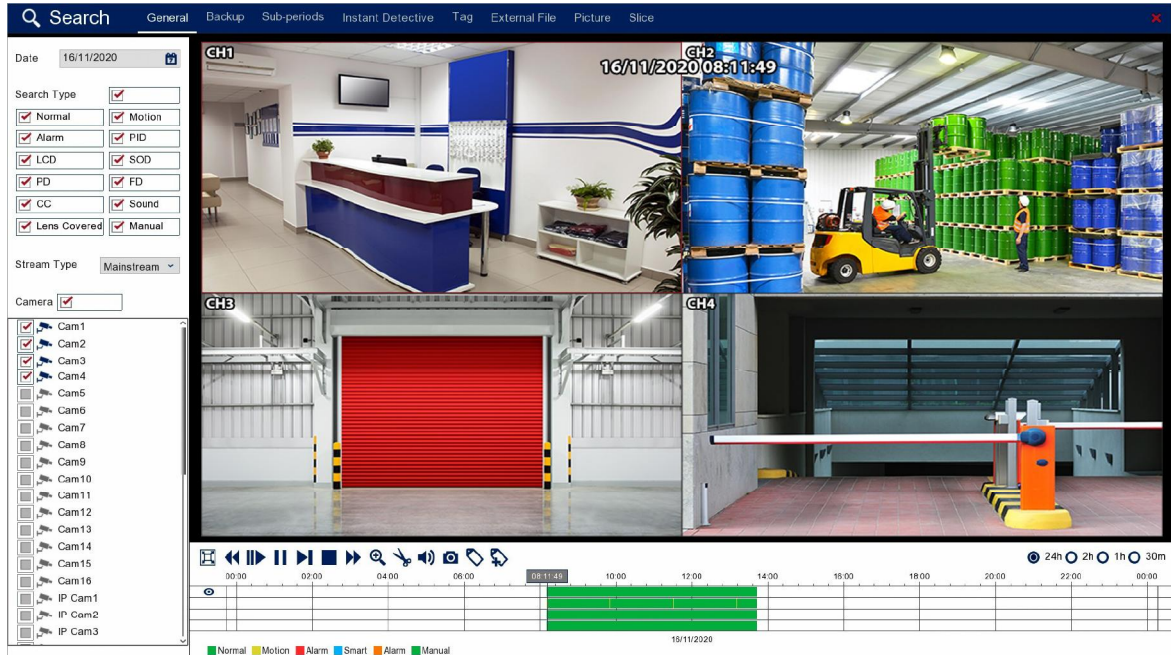

### Playback Toolbar

For more information on using the playback controls see the [Playback Toolbar Explained](#) <sup>65</sup> section.

### Date

when you open the Playback screen it will automatically start on the current day. To view footage from a different day click the **Calendar** icon to display the calendar screen as shown below.



You can change the month and year using the blue arrows then select a date by clicking on it. An orange line underneath a date indicates that footage was captured on that day.

## Search Type

Choosing the Search Type allows you to filter which footage is replayed based on what triggered the recording in the first place. For example, if you only select Alarm you will only see footage which was recorded because of an alarm trigger. By default all search types are selected. You can select any combination of search types or you can tick and untick the box next to Search Type to select or deselect all search types.

Search Type	<input checked="" type="checkbox"/>
<input checked="" type="checkbox"/> Normal	<input checked="" type="checkbox"/> Motion
<input checked="" type="checkbox"/> Alarm	<input checked="" type="checkbox"/> PID
<input checked="" type="checkbox"/> LCD	<input checked="" type="checkbox"/> SOD
<input checked="" type="checkbox"/> PD	<input checked="" type="checkbox"/> FD
<input checked="" type="checkbox"/> CC	<input checked="" type="checkbox"/> Sound
<input checked="" type="checkbox"/> Lens Covered	<input checked="" type="checkbox"/> Manual

**Normal:** Shows all footage recorded from constant recording or normal [Scheduled Recordings](#)<sup>(211)</sup>.

**Motion:** Only shows footage which was captured from [Motion Detection](#)<sup>(220)</sup>.

**Alarm:** Only shows footage which was captured as the result of an [Alarm Trigger](#)<sup>(223)</sup>.

**PID:** Only shows footage which was captured as the result of a [PID \(Perimeter Intrusion Detection\)](#)<sup>(163)</sup> trigger.

**LCD:** Only shows footage which was captured as the result of a [LCD \(Line Crossing Detection\)](#)<sup>(167)</sup> trigger.

**SOD:** Only shows footage which was captured as the result of a [SOD \(Stationary Object Detection\)](#)<sup>(171)</sup> trigger.

**PD:** Only shows footage which was captured as the result of a [PD \(Pedestrian Detection\)](#)<sup>(175)</sup> trigger.

**FD:** Only shows footage which was captured as the result of a [FD \(Face Detection\)](#)<sup>(180)</sup> trigger.

**CC:** Only shows footage which was captured as the result of a [CC \(Cross Counting\)](#)<sup>(186)</sup> trigger.

**Sound:** Only shows footage which was captured as the result of a [Sound Detection](#)<sup>(190)</sup> trigger.

**Manual:** Only shows footage which was captured manually by pressing or clicking record.

## Stream Type

The Stream Type drop down list allows you to filter between Mainstream and Substream recordings.



A screenshot of a web interface showing a dropdown menu for 'Stream Type'. The menu is currently set to 'Mainstream' with a downward arrow next to it.

## Camera Selection

By ticking and unticking the check boxes next to the cameras you can set which cameras are displayed during playback. Cameras which didn't recorded footage on the selected date will be greyed out and unavailable for selection. You can select any combination of cameras or you can tick and untick the box next to Cameras to select or deselect all cameras.

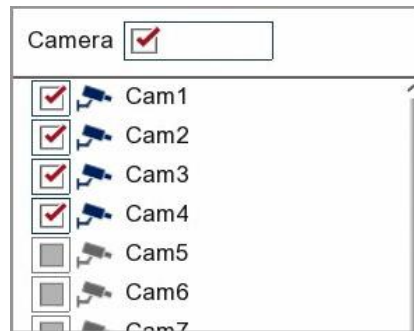

A screenshot of a web interface for camera selection. At the top, there is a 'Camera' label and a checked checkbox. Below this is a list of seven cameras, each with a checkbox and a camera icon. The first four cameras (Cam1, Cam2, Cam3, Cam4) have checked checkboxes and are in color. The last three cameras (Cam5, Cam6, Cam7) have unchecked checkboxes and are greyed out.

Camera	Selected
Cam1	<input checked="" type="checkbox"/>
Cam2	<input checked="" type="checkbox"/>
Cam3	<input checked="" type="checkbox"/>
Cam4	<input checked="" type="checkbox"/>
Cam5	<input type="checkbox"/>
Cam6	<input type="checkbox"/>
Cam7	<input type="checkbox"/>

### 7.3 Playback - Backup

The Backup screen is where you can export recorded footage to a USB storage device. You can use the panel on the left hand side of the screen to search for footage by date, time, type and camera as explained below.

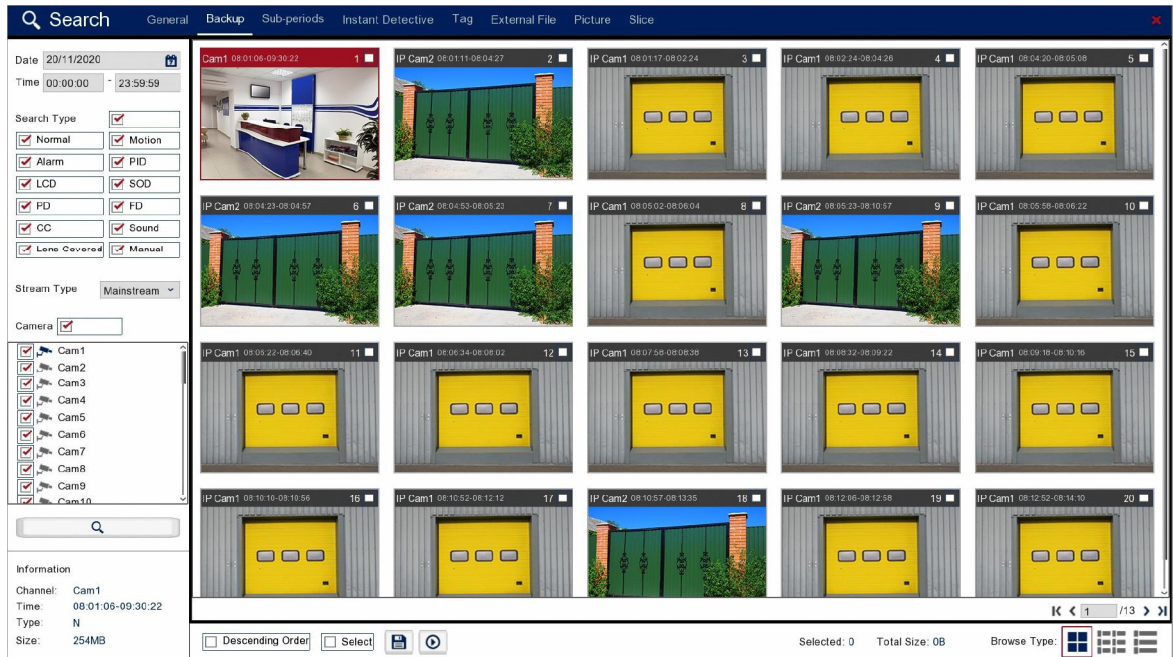

#### Date & Time

when you open the Backup screen it will automatically start on the current day with the time set from 00:00 to 23:59 to cover the full days recordings.

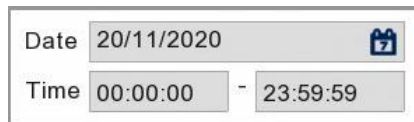

To view footage from a different day click the **Calendar** icon to display the calendar screen as shown below.

◀		Nov.		▶		◀		2020		▶	
SUN	MON	TUE	WED	THU	FRI	SAT					
25	26	27	28	29	30	31					
1	2	3	4	5	6	7					
8	9	10	11	12	13	14					
15	16	17	18	19	20	21					
22	23	24	25	26	27	28					
29	30	1	2	3	4	5					

You can change month and year using the blue arrows then select a date by clicking on it. An orange line underneath a date indicates that footage was captured on that day.

### Search Type

Choosing the Search Type allows you to filter which footage is replayed based on what triggered the recording in the first place. For example, if you only select Alarm you will only see footage which was recorded because of an alarm trigger. By default all search types are selected. You can select any combination of search types or you can tick and untick the box next to Search Type to select or deselect all search types.

Search Type	<input checked="" type="checkbox"/>
<input checked="" type="checkbox"/> Normal	<input checked="" type="checkbox"/> Motion
<input checked="" type="checkbox"/> Alarm	<input checked="" type="checkbox"/> PID
<input checked="" type="checkbox"/> LCD	<input checked="" type="checkbox"/> SOD
<input checked="" type="checkbox"/> PD	<input checked="" type="checkbox"/> FD
<input checked="" type="checkbox"/> CC	<input checked="" type="checkbox"/> Sound
<input checked="" type="checkbox"/> Lens Covered	<input checked="" type="checkbox"/> Manual

**Normal:** Shows all footage recorded from constant recording or normal [Scheduled Recordings](#)<sup>(211)</sup>.

**Motion:** Only shows footage which was captured from [Motion Detection](#)<sup>(220)</sup>.

**Alarm:** Only shows footage which was captured as the result of an [Alarm Trigger](#)<sup>(223)</sup>.

**PID:** Only shows footage which was captured as the result of a [PID \(Perimeter Intrusion Detection\)](#)<sup>(163)</sup> trigger.

**LCD:** Only shows footage which was captured as the result of a [LCD \(Line Crossing Detection\)](#)<sup>(167)</sup> trigger.

**SOD:** Only shows footage which was captured as the result of a [SOD \(Stationary Object Detection\)](#)<sup>(171)</sup> trigger.



**PD:** Only shows footage which was captured as the result of a [PD \(Pedestrian Detection\)](#)<sup>(175)</sup> trigger.

**FD:** Only shows footage which was captured as the result of a [FD \(Face Detection\)](#)<sup>(180)</sup> trigger.

**CC:** Only shows footage which was captured as the result of a [CC \(Cross Counting\)](#)<sup>(186)</sup> trigger.

**Sound:** Only shows footage which was captured as the result of a [Sound Detection](#)<sup>(190)</sup> trigger.

**Manual:** Only shows footage which was captured manually by pressing or clicking record.

### Stream Type

The Stream Type drop down list allows you to filter between Mainstream and Substream recordings.



### Camera Selection

By ticking and unticking the check boxes next to the cameras you can set which cameras are displayed during playback. Cameras which didn't recorded footage on the selected date will be greyed out and unavailable for selection. You can select any combination of cameras or you can tick and untick the box next to Cameras to select or deselect all cameras.

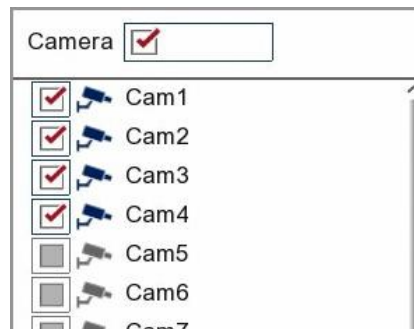

Once you are ready click the **Search** button to display all recordings which match your chosen parameters.



### Selecting Footage

Recordings are split into segments so that you can backup portions of the day covering the events you need rather than having to backup the entire day.

In the header of each segment's thumbnail you will see the name of the camera the footage was captured from as well as the time period the segment covers.



To select a recording segment just tick the box in the top right corner. You can select multiple recording segments and back them up at the same time.

When a large number of recordings are found they will appear over multiple pages. To switch between pages use the control arrows in the bottom right corner.



### Segment Information

The information pane in the bottom left corner of the screen shows the channel the recording was captured from, the start and end time of the recording, the recording trigger and the file size of the recording.

### Backup Toolbar Explained

There is also a toolbar at the bottom of the screen to help with your selection as explained below.





Icon	Name	Function
<input type="checkbox"/> Descending Order	<b>Descending Order</b>	By default the recording segments are in order from oldest to newest. To view the newest recording first tick the check box next to Descending Order.
<input type="checkbox"/> Select	<b>Select</b>	You can select and de-select all recording segments by ticking or unticking the Select check box.
	<b>Save</b>	Click Save when you are ready to backup. You will be given a choice of 3 file formats.
	<b>Play</b>	Click Play to view the <a href="#">Backup Preview</a> <sup>(81)</sup> screen where you can view footage before backing up.
Selected: 0	<b>Selected</b>	Shows the number of recording segments selected.
Total Size: 0B	<b>Total Size</b>	Shows the total file size of all selected recording segments.
	<b>Thumbnail View</b>	Displays recordings as thumbnail images with camera name, start and end time.
	<b>List View</b>	Displays recordings in a simple list view showing camera name and start time.
	<b>Detailed List View</b>	Displays recordings in a detailed list view showing camera name, recording type, date, start time, end time, file size, quick playback and lock.

### Saving Footage

When you are ready to backup your footage click the **Save** button on the toolbar. The following window will be displayed showing the total file size of all the footage being backed up.

You also have 3 options for the file format. Qzip is secure, encrypted file format which can only be played back using **Zippy player** which can be downloaded from [SoftCCTV.com](http://SoftCCTV.com). You can also save the clipping as an AVI or MP4 video file which can be viewed on most media devices.

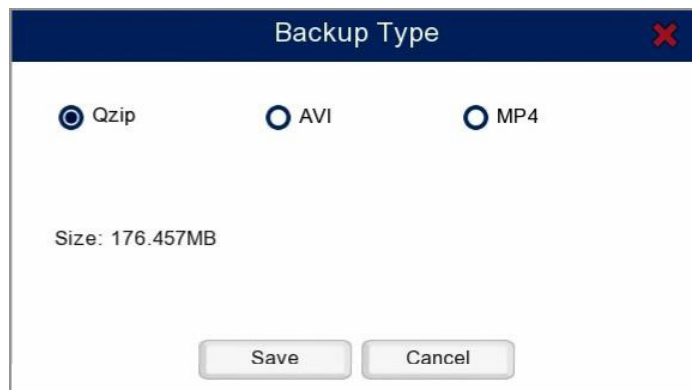

When you have made your selection click **Save**. A **Backup** window will display where you can choose and manage you backup device. For more information see the [Backup<sup>\(317\)</sup>](#) section.



### Locking Footage

You can **Lock** footage so that it is not overwritten keeping it safe for backup or playback at a later date. To do this enter the **Backup** screen then can then click the **Detailed List View** icon as described above. Each recording has a unlocked padlock icon at the end of the line listing. Simply click the unlocked padlock icon to lock the footage. The icon will then change to a locked padlock to show the footage is now locked.

### 7.3.1 Playback - Backup Preview

In the Backup Preview screen you can watch your recording(s) before backing them up. This is a great way to make sure you're backing up the correct footage.

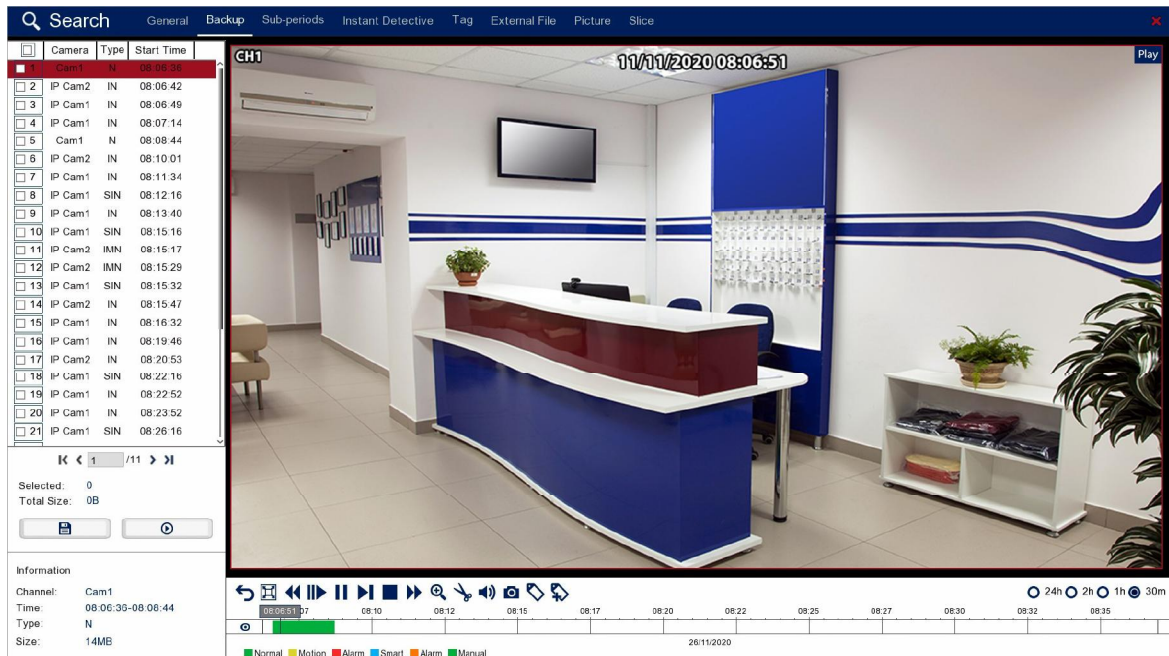

#### Playback Toolbar

For more information on using the playback controls see the [Playback Toolbar Explained](#) <sup>65</sup> section.

#### Selecting Recordings

In the left hand panel all of the recordings matching the original backup search parameters will be displayed.

When a large number of recordings are found they will appear over multiple pages. To switch between pages use the control arrows in the bottom right corner.



#### Previewing Recordings

To preview a recording you will first need to select it so that it is highlighted in red, once selected press the play button in the left hand panel to view the recording.

### File Information

The Information panel in the bottom left corner displays the key details of the highlighted file:

**Channel:** Shows the name of the channel the recording was captured from.

**Time:** Shows the start and end time of the recording.

**Type:** The recording type shows what triggered the recording.

**Size:** Shows the file size of the recording.



### Saving Footage

You can backup individual recordings or multiple recordings at the same time. To backup up recording(s) simply tick the check box next to the recording(s) you want to save in the left hand panel then.

When you are ready to backup your footage click the **Save** button. The following window will be displayed showing the total file size of all the footage being backed up.

You also have 3 options for the file format. Qzip is secure, encrypted file format which can only be played back using **Zippy player** which can be downloaded from [SoftCCTV.com](http://SoftCCTV.com). You can also save the clipping as an AVI or MP4 video file which can be viewed on most media devices.

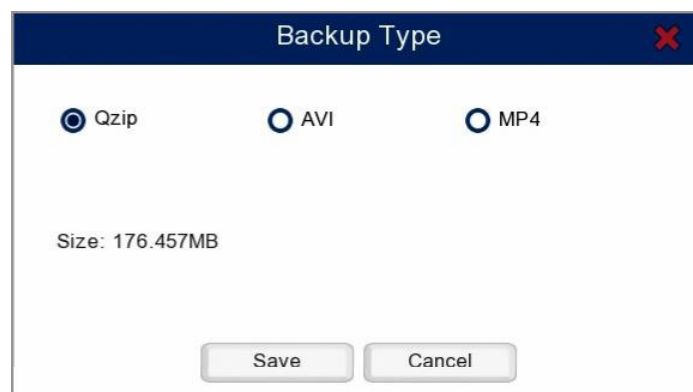

When you have made your selection click **Save**. A **Backup** window will display where you can choose and manage you backup device. For more information see the [Backup](#)<sup>317</sup> section.

## 7.4 Playback - Sub-periods

The Sub-period playback screen is another quick and easy way to see when an incident occurred. It's especially suited to low traffic areas where it would be easy to spot something out of the ordinary.

Sub-period playback allows you to split 1 camera's recorded footage from a selected day into equal segments. The segments are then played back at the same time in a split screen display. The recorded footage can be split into a maximum 16 segments so you can review a full days worth of footage in a relatively short amount of time.



### Playback Toolbar

For more information on using the playback controls see the [Playback Toolbar Explained](#) <sup>65</sup> section.

### Date & Time

when you open the Sub-Periods screen it will automatically start on the current day with the time set from 00:00 to 23:59 to cover the full days recordings.

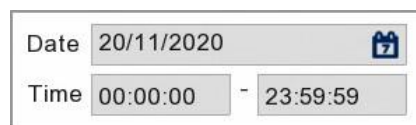

To view footage from a different day click the **Calendar** icon to display the calendar screen as shown below.

◀		Nov.		▶		◀		2020		▶	
SUN	MON	TUE	WED	THU	FRI	SAT					
25	26	27	28	29	30	31					
1	2	3	4	5	6	7					
8	9	10	11	12	13	14					
15	16	17	18	19	20	21					
22	23	24	25	26	27	28					
29	30	1	2	3	4	5					

You can change month and year using the blue arrows then select a date by clicking on it. An orange line underneath a date indicates that footage was captured on that day.

### Search Type

Choosing the Search Type allows you to filter which footage is replayed based on what triggered the recording in the first place. For example, if you only select Alarm you will only see footage which was recorded because of an alarm trigger. By default all search types are selected. You can select any combination of search types or you can tick and untick the box next to Search Type to select or deselect all cameras.

Search Type	<input checked="" type="checkbox"/>
<input checked="" type="checkbox"/> Normal	<input checked="" type="checkbox"/> Motion
<input checked="" type="checkbox"/> Alarm	<input checked="" type="checkbox"/> PID
<input checked="" type="checkbox"/> LCD	<input checked="" type="checkbox"/> SOD
<input checked="" type="checkbox"/> PD	<input checked="" type="checkbox"/> FD
<input checked="" type="checkbox"/> CC	<input checked="" type="checkbox"/> Sound
<input checked="" type="checkbox"/> Lens Covered	<input checked="" type="checkbox"/> Manual

**Normal:** Shows all footage recorded from constant recording or normal [Scheduled Recordings](#)<sup>(211)</sup>.

**Motion:** Only shows footage which was captured from [Motion Detection](#)<sup>(220)</sup>.

**Alarm:** Only shows footage which was captured as the result of an [Alarm Trigger](#)<sup>(223)</sup>.

**PID:** Only shows footage which was captured as the result of a [PID \(Perimeter Intrusion Detection\)](#)<sup>(163)</sup> trigger.

**LCD:** Only shows footage which was captured as the result of a [LCD \(Line Crossing Detection\)](#)<sup>(167)</sup> trigger.

**SOD:** Only shows footage which was captured as the result of a [SOD \(Stationary Object Detection\)](#)<sup>(171)</sup> trigger.

**PD:** Only shows footage which was captured as the result of a [PD \(Pedestrian Detection\)](#)<sup>(175)</sup> trigger.

**FD:** Only shows footage which was captured as the result of a [FD \(Face Detection\)](#)<sup>(180)</sup> trigger.

**CC:** Only shows footage which was captured as the result of a [CC \(Cross Counting\)](#)<sup>(186)</sup> trigger.

**Sound:** Only shows footage which was captured as the result of a [Sound Detection](#)<sup>(190)</sup> trigger.

**Manual:** Only shows footage which was captured manually by pressing or clicking record.

### Stream Type

The Stream Type drop down list allows you to filter between Mainstream and Substream recordings.



### Camera Selection

By ticking and unticking the check boxes next to the camera you can set which camera is displayed during Sub-period playback. Cameras which didn't recorded footage on the selected date will be greyed out and unavailable for selection.

For Sub-Period playback you can only select 1 camera at a time so you will notice that once you select a camera, all of the other cameras are greyed out with a red padlock symbol.

To select a different camera you will first have to de-select the current camera to unlock all the other cameras.

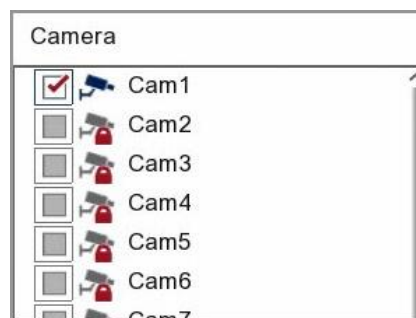

### Playing Footage

When you have configured your search and selected your camera as explained above, press the **Play** button on the toolbar to start playback.



## 7.5 Playback - Instant Detective

Instant Detective is one of the recorder's best features. It analyses footage retrospectively to quickly find events that have occurred.

With Instant Detective you can draw a box over an area of the image on previously recorded footage. The recorder will then search for and display all footage where there was movement inside that area. As an example this could be used to find people entering or exiting a door way, removing items from a shelf or taking a car from a driveway.

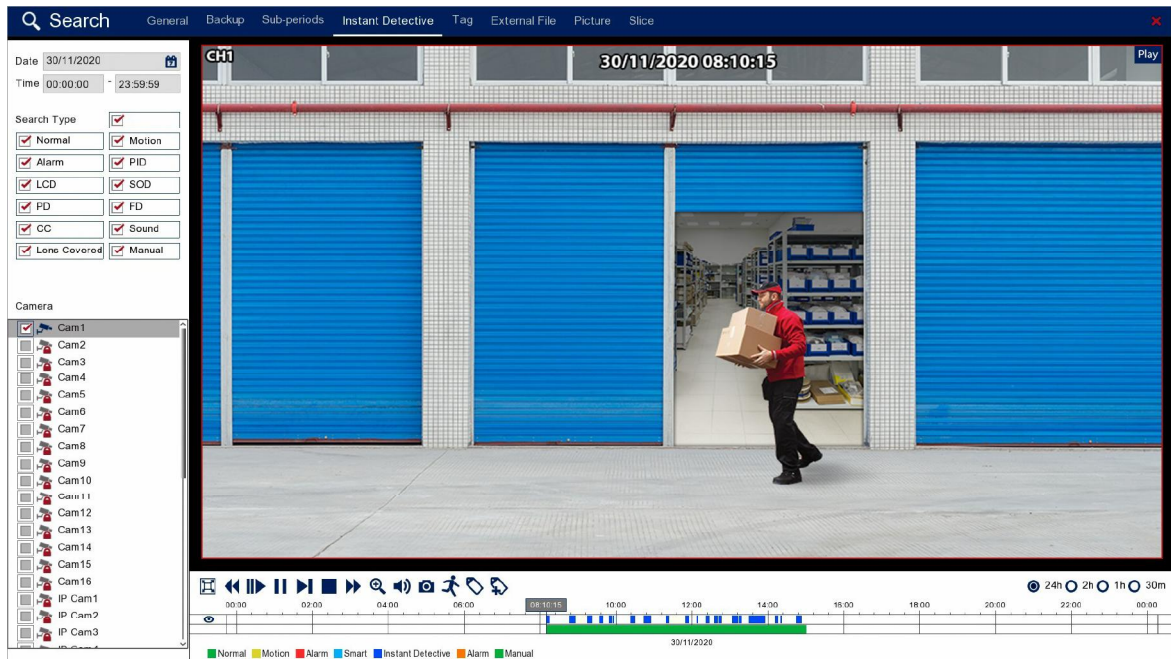

### Playback Toolbar

For more information on using the playback controls see the [Playback Toolbar Explained](#)<sup>65</sup> section.

### Date & Time

when you open the Instant Detective screen it will automatically start on the current day with the time set from 00:00 to 23:59 to cover the full days recordings.

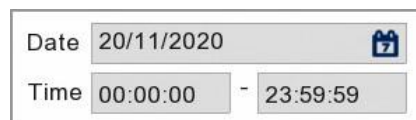

To view footage from a different day click the **Calendar** icon to display the calendar screen as shown below.



◀		Nov.		▶		◀		2020		▶	
SUN	MON	TUE	WED	THU	FRI	SAT					
25	26	27	28	29	30	31					
1	2	3	4	5	6	7					
8	9	10	11	12	13	14					
15	16	17	18	19	20	21					
22	23	24	25	26	27	28					
29	30	1	2	3	4	5					

You can change month and year using the blue arrows then select a date by clicking on it. An orange line underneath a date indicates that footage was captured on that day.

### Search Type

Choosing the Search Type allows you to filter which footage is replayed based on what triggered the recording in the first place. For example, if you only select Alarm you will only see footage which was recorded because of an alarm trigger. By default all search types are selected. You can select any combination of search types or you can tick and untick the box next to Search Type to select or deselect all search types.

Search Type	<input checked="" type="checkbox"/>
<input checked="" type="checkbox"/> Normal	<input checked="" type="checkbox"/> Motion
<input checked="" type="checkbox"/> Alarm	<input checked="" type="checkbox"/> PID
<input checked="" type="checkbox"/> LCD	<input checked="" type="checkbox"/> SOD
<input checked="" type="checkbox"/> PD	<input checked="" type="checkbox"/> FD
<input checked="" type="checkbox"/> CC	<input checked="" type="checkbox"/> Sound
<input checked="" type="checkbox"/> Lens Covered	<input checked="" type="checkbox"/> Manual

**Normal:** Shows all footage recorded from constant recording or normal [Scheduled Recordings](#)<sup>(211)</sup>.

**Motion:** Only shows footage which was captured from [Motion Detection](#)<sup>(220)</sup>.

**Alarm:** Only shows footage which was captured as the result of an [Alarm Trigger](#)<sup>(223)</sup>.

**PID:** Only shows footage which was captured as the result of a [PID \(Perimeter Intrusion Detection\)](#)<sup>(163)</sup> trigger.

**LCD:** Only shows footage which was captured as the result of a [LCD \(Line Crossing Detection\)](#)<sup>(167)</sup> trigger.

**SOD:** Only shows footage which was captured as the result of a [SOD \(Stationary Object Detection\)](#)<sup>(171)</sup> trigger.

**PD:** Only shows footage which was captured as the result of a [PD \(Pedestrian Detection\)](#)<sup>(175)</sup> trigger.

**FD:** Only shows footage which was captured as the result of a [FD \(Face Detection\)](#)<sup>(180)</sup> trigger.

**CC:** Only shows footage which was captured as the result of a [CC \(Cross Counting\)](#)<sup>(186)</sup> trigger.

**Sound:** Only shows footage which was captured as the result of a [Sound Detection](#)<sup>(190)</sup> trigger.

**Manual:** Only shows footage which was captured manually by pressing or clicking record.

## Camera Selection

By ticking and unticking the check boxes next to the camera you can set which camera is displayed during Instant Detective playback. Cameras which didn't recorded footage on the selected date will be greyed out and unavailable for selection.

For Instant Detective playback you can only select 1 camera at a time so you will notice that once you select a camera, all of the other cameras are greyed out with a red padlock symbol.

To select a different camera you will first have to de-select the current camera to unlock all the other cameras.

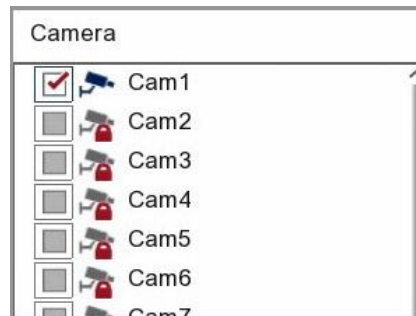

## Setting The Inspection Area

By default the detection area is set to the entire screen. This is fine for low traffic areas where you want to view any movement but in most cases you will only want to see movement in a portion of the image.

To set the detection area click the **Instant Detective** Icon in the Playback Toolbar. This will then display the **Detection Area** screen. You can configure the detection area as described in the [Playback - Instant Detective - Detection Area](#)<sup>(90)</sup> section.

## Playing Footage

To start playback click the **Play** button in the Playback Toolbar.

Periods of footage where movement was detected within the detection area will appear as dark blue sections on the playback timeline.

Playback will begin at the first section of footage where movement was detected. When playback reaches the end of a section it will automatically jump to the next section and continue playback.

### 7.5.1 Playback - Instant Detective - Detecion Area

When You first enter the Detection Area screen you you will see a red grid covering the entire image by default as shown below. As Instant Detective searches for movement within the gridded area it will search for any movement within the entire screen if left as is.

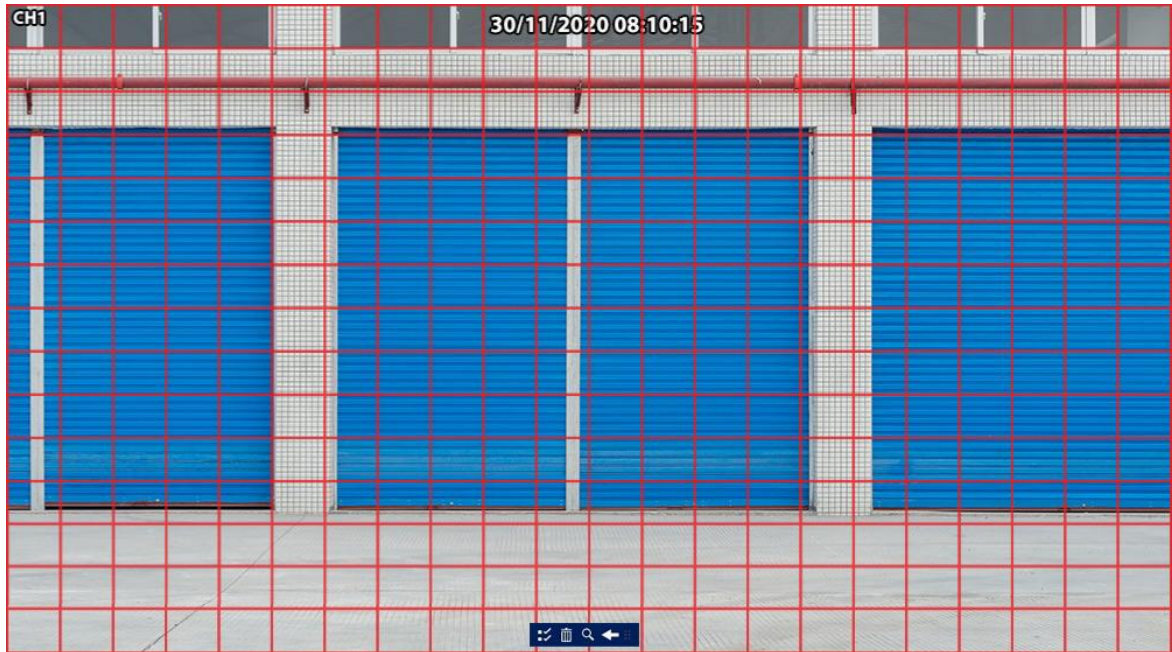

#### Detection Area Toolbar

There is a small toolbar at the bottom of the screen to help with setting your detection area and searching for results.

Icon	Name	Function
	<b>Select All</b>	Clicking Select all will select the entire screen drawing a grid over it as shown above. Clicking Search now would search for movement in the entire image.
	<b>Clear All</b>	Click the Clear All button to remove all currently selected areas.
	<b>Search</b>	The Search button will look through the selected days recordings for movement in the gridded area and display the results in the <a href="#">Instant Detective Playback Screen</a> <sup>(86)</sup> .
	<b>Exit</b>	Clicking exit will return to the Instant Detective playback screen without searching for movement.
	<b>Handle</b>	Click and drag Handle to move the Tool Bar around the screen.

## Setting A Detection Area

The easiest way to set a new detection area is to first remove any current detection areas using the **Clear All** button. You can click and drag using the left mouse button to select the new detection area.

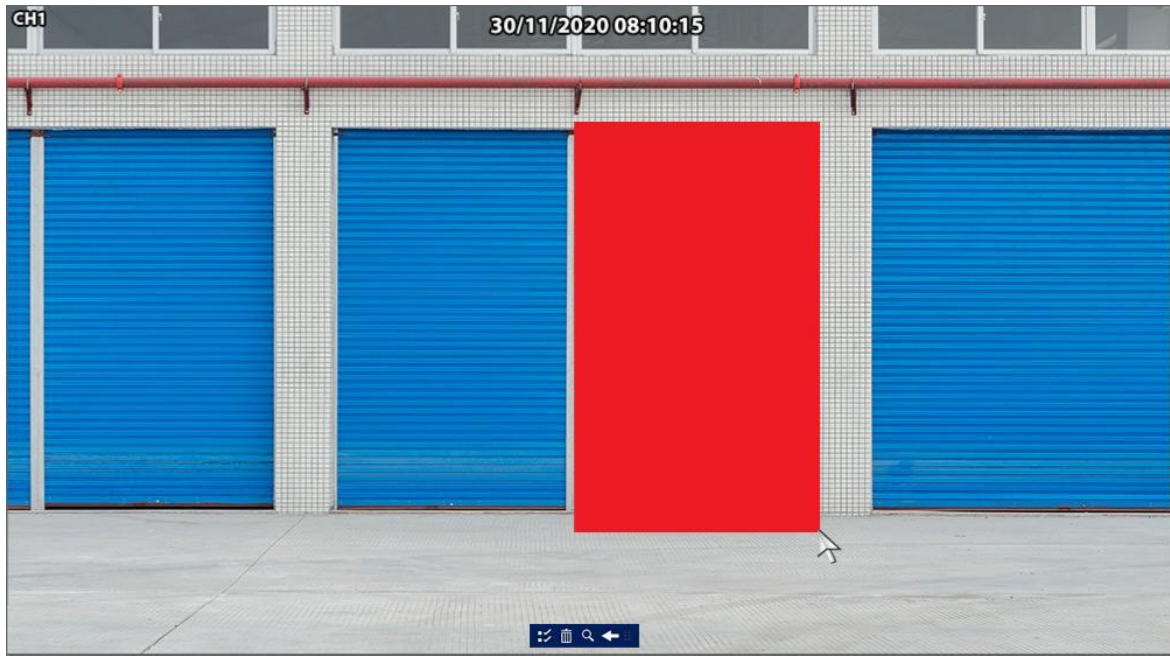

Once you release the left mouse button your selected area will be converted to a detection area grid. You can draw multiple grids around the camera's image in required.

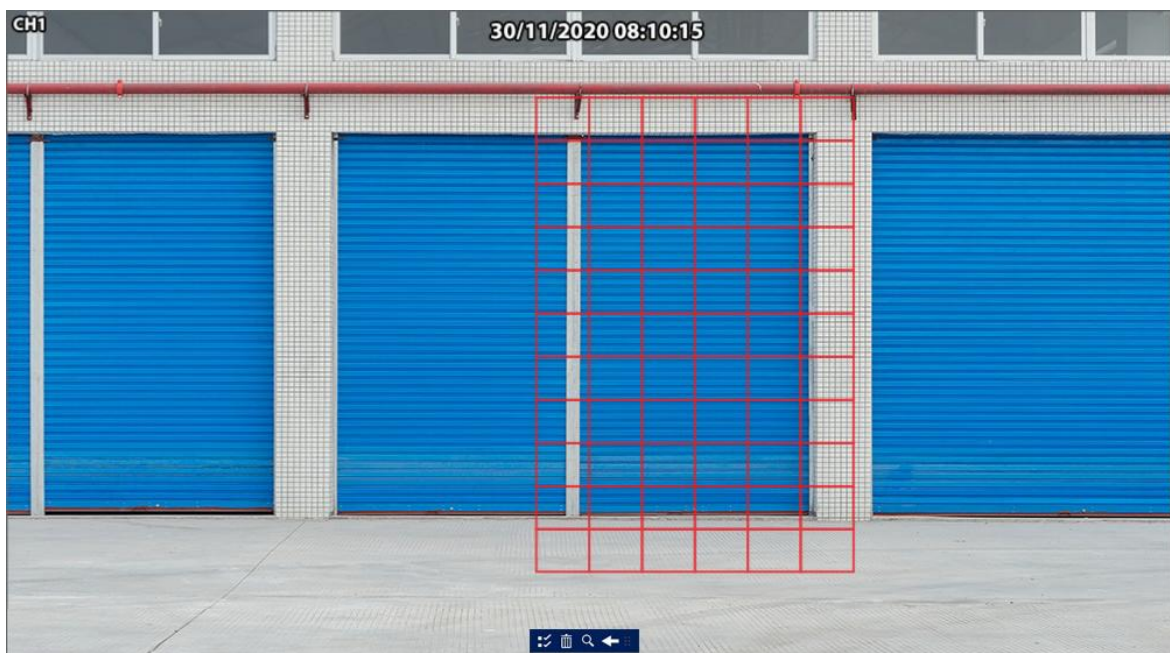

## Removing A Detection Area

To remove all detection areas just use the Clear All button. However, you can also remove parts of detection areas by left clicking and dragging over the section of a detection area grid you want to remove.



## 7.6 Playback - Tag

The Tag screen shows previously saved [video tags](#)<sup>71</sup> so it's really easy to find the exact footage you're looking for. Default and Customised tags will be displayed in order from oldest to newest for the selected date range.

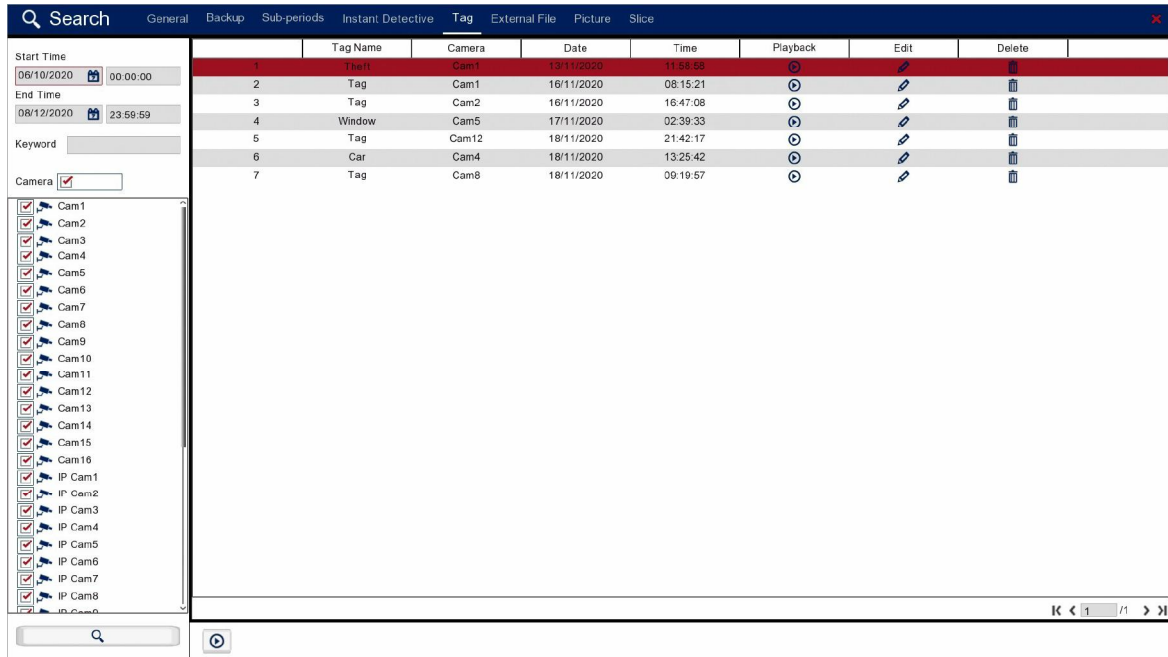

### Date & Time

when you open the Tag Playback screen it will automatically start on the current day with the time set from 00:00 to 23:59 to cover the full days recordings.



To set a different start or end date click the **Calendar** icon to display the calendar screen as shown below.



You can change the month and year using the blue arrows then select a date by clicking on it.

### Keyword

The Keyword field enables you to search for tags by name. This is the fastest way to recall tagged footage as you can jump to a specific tag. This is really handy when you have a large number of tags saved which would span multiple search result pages.



When you click inside the Keyword field the [virtual keyboard](#)<sup>31</sup> will be displayed so that you can enter the name of the tag you are looking for.

### Camera Selection

When you search for tags the recorder will look for any tags assigned to the footage of all selected cameras within the specified date and time. You can set which cameras are selected by ticking and unticking the check boxes next to the cameras's icon. You can select any combination of cameras or you can tick and untick the box next to Cameras to select or deselect all cameras.

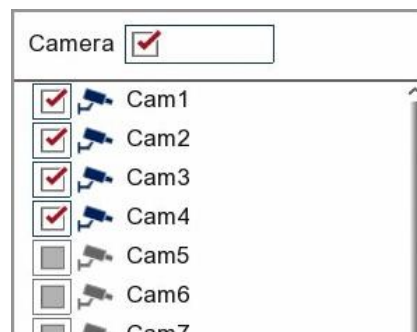

Once you are ready click the **Search** button to display all tags which match your chosen parameters.





### Search Results

When you click **Search** all tags matching the search parameters will be displayed in the main section of the screen.

You will see the following details for each tag:

**Tag Name:** Shows the name allocated to the video tag,

**Camera:** Shows which cameras footage the tag was assigned to.

**Date:** Shows the date of the footage the tag has been assigned to.

**Time:** Shows the time of day the footage was added to.

When a large number of recordings are found they will appear over multiple pages. To switch between pages use the control arrows in the bottom right corner.



### Tagged Footage Playback

Clicking the **Playback** button will open the [Tag Playback](#)<sup>96</sup> screen and automatically start playing the selected (highlighted) tagged footage.

 **Edit Tag**

You can rename a tag name by clicking the **Edit** button to open the **Modify Tag** window.



The screenshot shows a dialog box titled "Modify Tag" with a red close button in the top right corner. The dialog contains the following information:

Camera	Cam1
Tag Time	2020/11/13 11:58:58
Tag Name	<input type="text" value="Theft"/>

At the bottom of the dialog are two buttons: "Save" and "Cancel".

Once you have renamed the tag click **Save**.

 **Delete Tag**

To delete a tag simply click the **Delete** icon on tag's record in the search result list.

### 7.6.1 Playback - Tag - Playback

The Tag playback screen will appear when you choose to play tagged footage in the [Tag](#)<sup>93</sup> screen. Playback will start automatically for the selected tag and all tags matching the original search parameters will be displayed in the left panel.

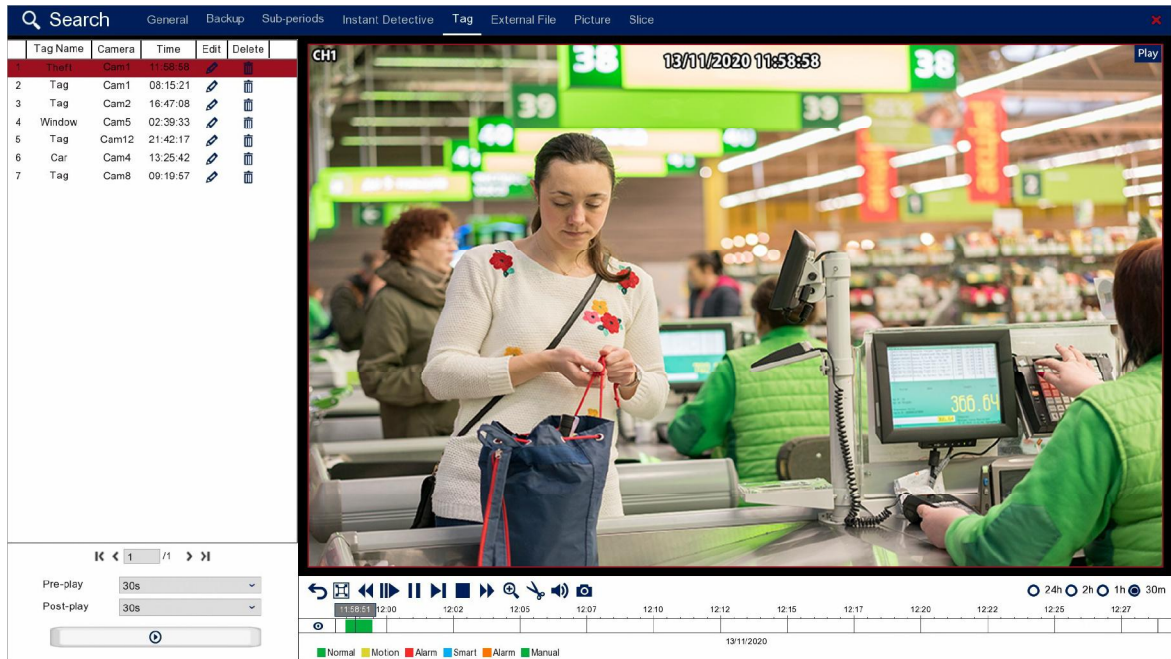

### Playback Toolbar

For more information on using the playback controls see the [Playback Toolbar Explained](#)<sup>65</sup> section.

### Tagged Footage Playback

To playback a video tag you first select the tag you want from the list in the left hand panel.

Underneath the tag list you can set the Pre-play and Post-play times from the drop-down lists. The Pre-play determines the amount of time played before the tag and the Post-play determines the amount of time played after the tag. Both the Pre-play and Post-play can be set from as little as 5 seconds up to a maximum of 10 minutes. By default they will both be set to 30 seconds.

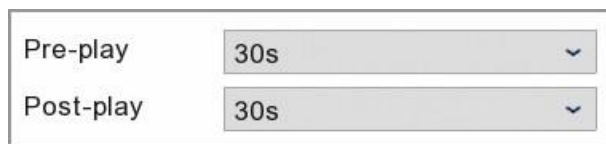

Once you have chosen your tag and set the Pre-play and Post-play time click the play button to view the footage.



 **Edit Tag**

You can rename a tag name by clicking the **Edit** button to open the **Modify Tag** window.



The screenshot shows a dialog box titled "Modify Tag" with a red close button in the top right corner. The dialog contains the following information:

Camera	Cam1
Tag Time	2020/11/13 11:58:58
Tag Name	<input type="text" value="Theft"/>

At the bottom of the dialog are two buttons: "Save" and "Cancel".

Once you have renamed the tag click **Save**.

 **Delete Tag**

To delete a tag simply click the **Delete** icon on tag's record in the search result list.

 **Saving Video Clips**

To backup tagged footage use the **Snipping Tool** from the toolbar as explained in the [Snipping Tool](#)<sup>69</sup> section.

## 7.7 Playback - External File

In the External File playback screen you can play footage from a USB device connected to the recorder.

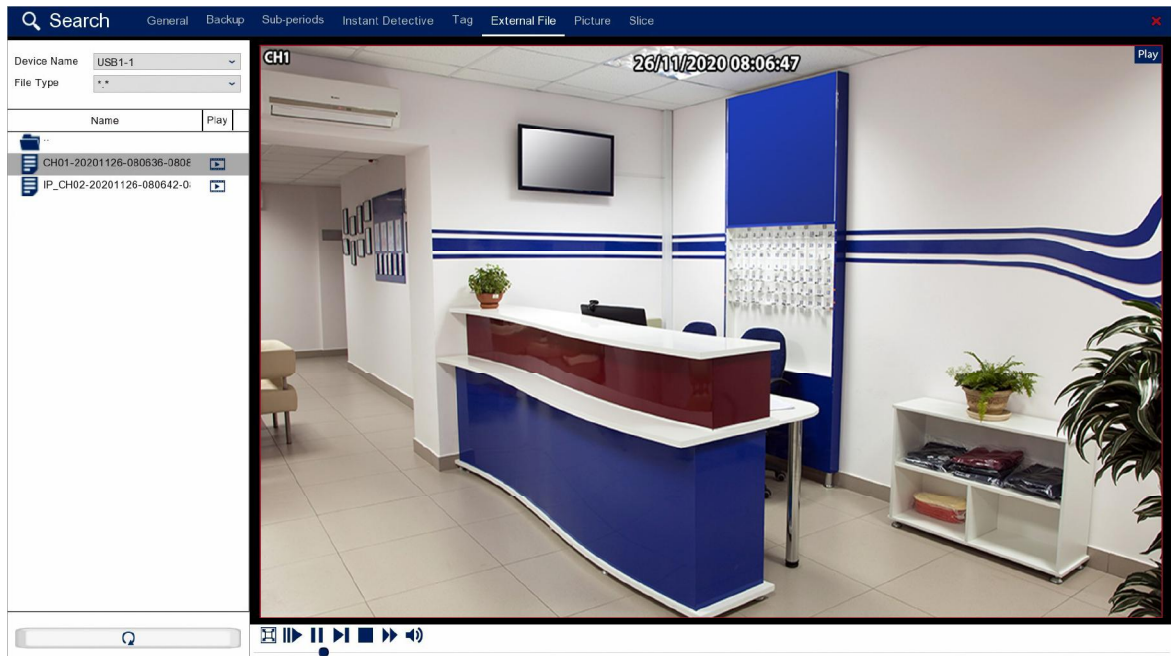

### Connecting A USB Device

If you already have your USB device connected to the recorder when you enter the External File screen the files and folders saved to the device should be visible in the left hand panel.

If your USB device is not visible in the left hand panel click the Refresh button and the recorder will check for any connected devices.



### Selecting A Device & File

In the top left hand corner of the screen you have 2 drop down lists, Device name and File Type.

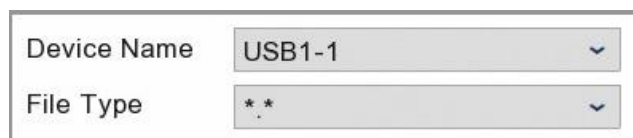

The Device Name drop down list shows all connected USB devices so you can choose which device you want to play footage from.

The File Type drop down list allows you to choose which file types are displayed e.g. MP4, AVI. This will filter out all other file types making it easier to find the footage you want to playback.

The file types available are:

\*.\* - This is the default setting and will display all file types.

\*.h264;\*.H264 - Will only display video files encoded in H264 format.

\*.rf;\*.RF - Will only display RF (Real Flash) video files.

\*.avi;\*.AVI - Will only display AVI video files.

\*.mp4;\*.MP4 - Will only display MP4 video files.

\*.Qzip - Will only display the Zip's own encoded Qzip video files. For added security Qzip files can only be played back on a Zip recorder or using the Zippy video player on a PC available from [SoftCCTV.com](http://SoftCCTV.com)



### Selecting Video File

You can navigate around the USB device by double clicking folder icons to enter them. To return to the previous folder just double click the folder icon at the very top of the list.

The video files saved from a Zip recorder are named in a way that includes the channel number, date, start time and end time of the footage. For example a file named CH01-20201126-080636-080851 was recorded from Channel 1, on the 26th of November 2020, from 08:06:36 to 08:08:51.

To play a video from the USB device click the play icon next to the file name.

### Playback Toolbar

For more information on using the playback controls see the [Playback Toolbar Explained](#)<sup>65</sup> section.

## 7.8 Playback - Picture

In the Picture Playback screen you can search for and view your previously captured snapshots. Snapshots can be saved using the Manual Capture button during [Live View](#)<sup>(39)</sup> or in the [Playback](#)<sup>(64)</sup> screen.

You can also configure cameras to capture snapshots at set intervals in the [Capture](#)<sup>(213)</sup> screen. Once you have set the capture parameters you will also need to setup a schedule to automatically capture snapshots for Normal, Alarm and Motion Detection in the [Capture Schedule](#)<sup>(216)</sup> screen.

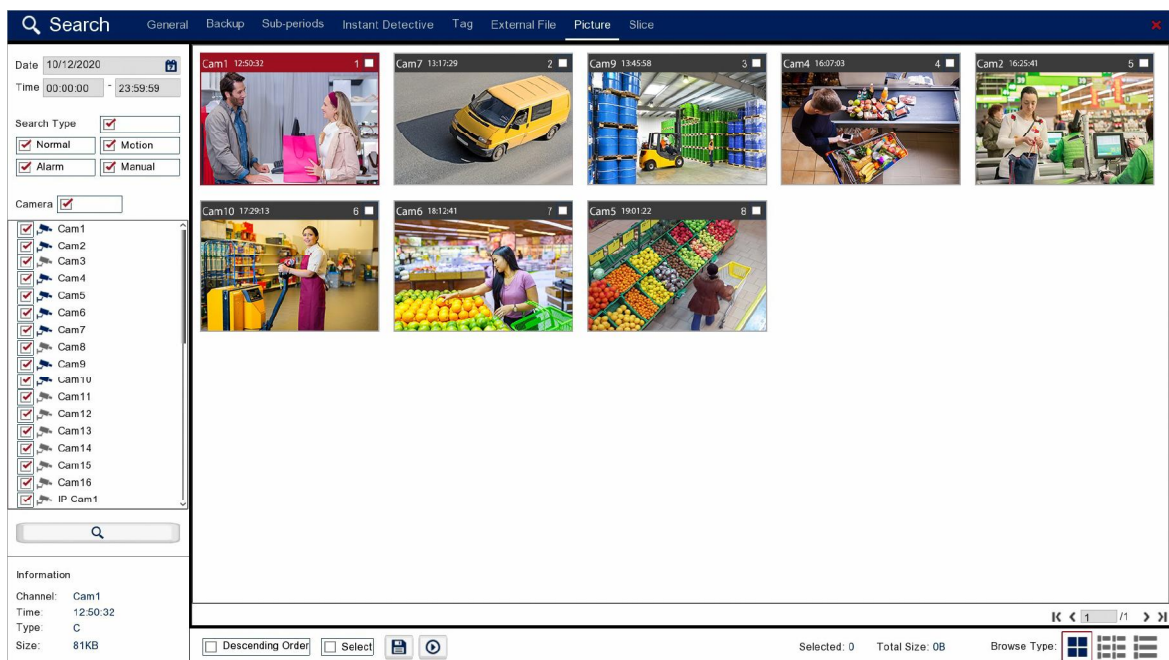

### Date & Time

when you open the Picture screen it will automatically start on the current day with the time set from 00:00 to 23:59 to cover the full days recordings.

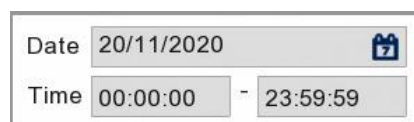

To set a different start or end date click the **Calendar** icon to display the calendar screen as shown below.



◀		Nov.		▶		◀		2020		▶	
SUN	MON	TUE	WED	THU	FRI	SAT					
25	26	27	28	29	30	31					
1	2	3	4	5	6	7					
8	9	10	11	12	13	14					
15	16	17	18	19	20	21					
22	23	24	25	26	27	28					
29	30	1	2	3	4	5					

You can change the month and year using the blue arrows then select a date by clicking on it.

### Search Type

Choosing the Search Type allows you to filter which snapshots are displayed based on what triggered the snapshot to be captured in the first place. For example, if you only select Alarm you will only see snapshots which were captured as the result of an alarm trigger. By default all search types are selected. You can select any combination of search types or you can tick and untick the box next to Search Type to select or deselect all search types.

Search Type	<input checked="" type="checkbox"/>
<input checked="" type="checkbox"/> Normal	<input checked="" type="checkbox"/> Motion
<input checked="" type="checkbox"/> Alarm	<input checked="" type="checkbox"/> Manual

**Normal:** Shows all snapshots captured at set intervals as configured in the [Capture](#)<sup>(213)</sup> screen.

**Motion:** Only shows snapshots which were captured as the result of a [Motion Detection](#)<sup>(220)</sup> trigger.

**Alarm:** Only shows footage which was captured as the result of an [Alarm Trigger](#)<sup>(223)</sup>.

**Manual:** Only shows footage which was captured manually by pressing or clicking the Manual Capture button.

### Camera Selection

You can choose which cameras you want display snapshots from by ticking and unticking the check boxes next to the cameras. Cameras which capture snapshots on the selected date will be greyed out and unavailable for selection. You can select any combination of cameras or you can tick and untick the box next to Cameras to select or deselect all cameras.



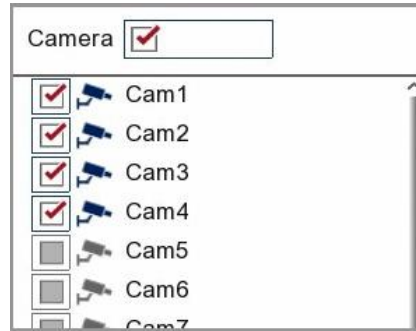

Once you are ready click the **Search** button to display all recordings which match your chosen parameters.



### Selecting Snapshots

In the header of each thumbnail you will see the name of the camera the footage was captured from as well as the time the snapshot was captured.



To select a snapshot just tick the box in the top right corner. You can select multiple snapshots and back them up at the same time.

When a large number of snapshots are found they will appear over multiple pages. To switch between pages use the control arrows in the bottom right corner.



### Snapshot Information

The information pane in the bottom left corner of the screen shows the channel the snapshot was captured from, the time of the snapshot, the snapshot trigger and the file size of the snapshot.

### Picture Toolbar Explained

There is also a toolbar at the bottom of the screen to help with your selection as explained below.



Icon	Name	Function
<input type="checkbox"/> Descending Order	<b>Descending Order</b>	By default the snapshots are in order from oldest to newest. To view the newest snapshot first tick the check box next to Descending Order.
<input type="checkbox"/> Select	<b>Select</b>	You can select and de-select all snapshots by ticking or unticking the Select check box.
	<b>Save</b>	Click Save when you are ready to backup. You will be taken to the <a href="#">Backup</a> <sup>317</sup> screen.
	<b>Play</b>	Click Play to view the <a href="#">Picture Preview</a> <sup>105</sup> screen where you can view snapshots before backing up.
Selected: 0	<b>Selected</b>	Shows the number of snapshots selected.
Total Size: 0B	<b>Total Size</b>	Shows the total file size of all selected snapshots.
	<b>Thumbnail View</b>	Displays snapshots as thumbnail images with camera name and capture time.
	<b>List View</b>	Displays snapshots in a simple list view showing camera name and capture time.
	<b>Detailed List View</b>	Displays snapshots in a detailed list view showing camera name, type, date, time, file size and playback.

### Saving Snapshots

When you are ready to backup your snapshot(s) click the **Save** button on the toolbar. A **Backup** window will display where you can choose and manage you backup device. For more information see the [Backup](#)<sup>317</sup> section.

### 7.8.1 Playback - Picture - Preview

The Picture Preview screen allows you to view the snapshot images for the chosen date. You can also backup your snapshots to a USB device.

When you first enter the Picture Preview screen the snapshots will playback automatically from the selected snapshot until the last snapshot.



#### Playback Toolbar

For more information on using the playback controls see the [Playback Toolbar Explained](#)<sup>65</sup> section.

#### Selecting Snapshots

The snapshot list shows basic information for each snapshot. The **Camera** column shows which camera the snapshot was captured from. The **Type** column shows what triggered the snapshot e.g. Normal, Alarm, Motion. The **Time** column shows the time the snapshot was captured.

<input type="checkbox"/>	Camera	Type	Time
<input checked="" type="checkbox"/> 1	Cam1	N	12:50:32
<input type="checkbox"/> 2	Cam7	N	13:17:29
<input type="checkbox"/> 3	Cam9	N	13:45:58
<input type="checkbox"/> 4	Cam4	N	16:07:03
<input type="checkbox"/> 5	Cam2	N	16:25:41
<input type="checkbox"/> 6	Cam10	N	17:29:13
<input type="checkbox"/> 7	Cam6	N	18:12:41
<input type="checkbox"/> 8	Cam5	N	19:01:22

To select a snapshot just tick the box at the start of the row. You can select any combination of snapshots or you can tick and untick the box above the check box column to select or deselect all snapshots.

When a large number of snapshots are found they will appear over multiple pages. To switch between pages use the control arrows in the bottom right corner.



### Snapshot Display

There are three display options for snapshot playback as explained below:

Icon	Name	Function
	<b>1 Window</b>	Displays one snapshot at a time as a fullscreen image.
	<b>4 Windows</b>	Displays four snapshots in a split screen view.
	<b>9 Windows</b>	Displays nine snapshots in a split screen view.

### Saving Snapshots

When you are ready to backup your snapshot(s) click the **Save** button in the left panel. A **Backup** window will display where you can choose and manage you backup device. For more information see the [Backup](#)<sup>317</sup> section.

## 7.9 Playback - Slice

In the Playback Slice screen you can quickly break down recordings into smaller and smaller sections until you find the event you are looking for. Each section is represented by a thumbnail giving you a snapshot of the events the section covers.

Starting at the top level you will see a thumbnail for each month, selecting the month will then show a thumbnail for each day. Looking at the thumbnails select the day you require then a thumbnail for each hour will be displayed. Finally selecting an hour thumbnail will display a thumbnail for each minute.

This is a really useful way of finding events where something has visually changed. For example acts of vandalism or the theft of a vehicle.

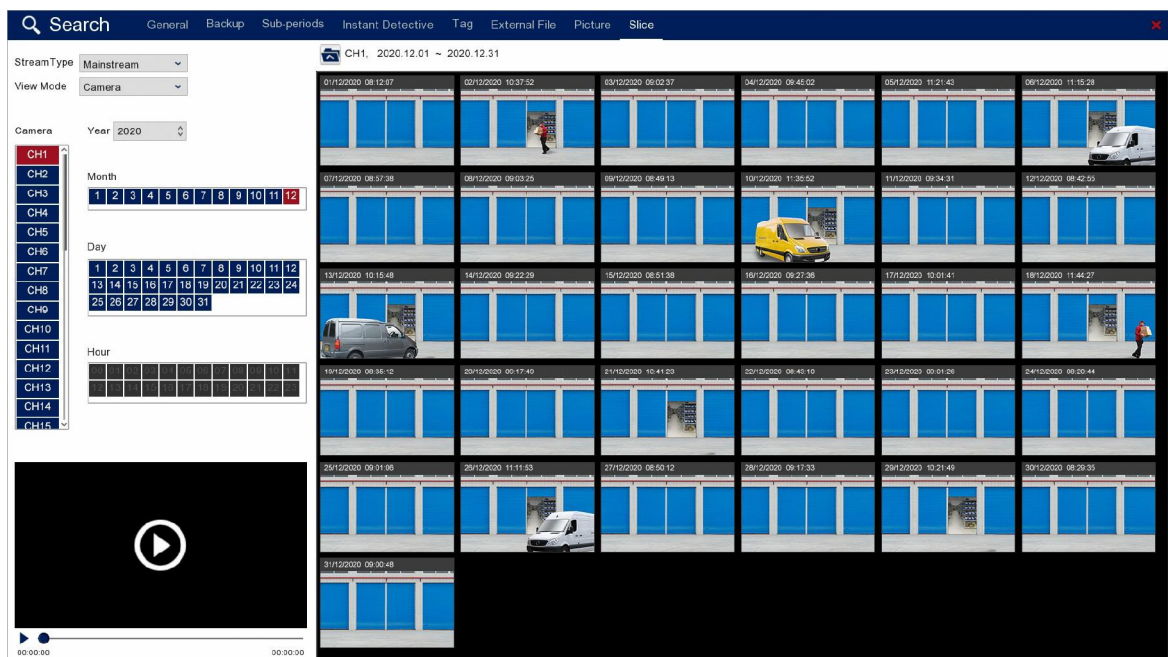

### Stream Type & Video Mode

You can choose to view either the **Mainstream** or **Substream** recordings from the drop down list. You can also change the view mode between **Camera** and **Time**.



### Camera Selection

Before you start searching for recordings you will need to choose which camera you want to view footage from in the left panel.



### Selecting The Year

You can use the **Up** and **Down** arrows in the Year field to select the year from which you want to find footage.



### Finding Footage

By comparing thumbnails you can quickly narrow down your search to find when an event occurred.

With the year set and the camera selected you will see 12 thumbnail images, one for each month. You can choose the month by selecting it in the left panel or simply double clicking the relevant thumbnail.

Once you have selected the month you will see a thumbnail for each day. As before you can select the day in the left panel or by double clicking a thumbnail.

When you have chosen the day, a thumbnail for each hour will be displayed and when you have chosen the hour you will see a thumbnail for each minute.

Finally when you select the minute (double click) the footage will start playing in the [Slice Playback](#)<sup>(110)</sup> window.

### Previewing Footage

You can preview footage in the small video window at the bottom left corner of the screen. To preview footage just single left click the thumbnail and it will start playing automatically.



To view the footage in the [Slice Playback](#)<sup>110</sup> screen just click the **Full Screen** icon in the top right corner of the preview window.



### 7.9.1 Playback - Slice - Playback

The Slice Playback screen allows you to view the selected video slice. You can also backup your video slice to a USB device.

When you first enter the Slice Playback screen the video will playback automatically from the selected slice.

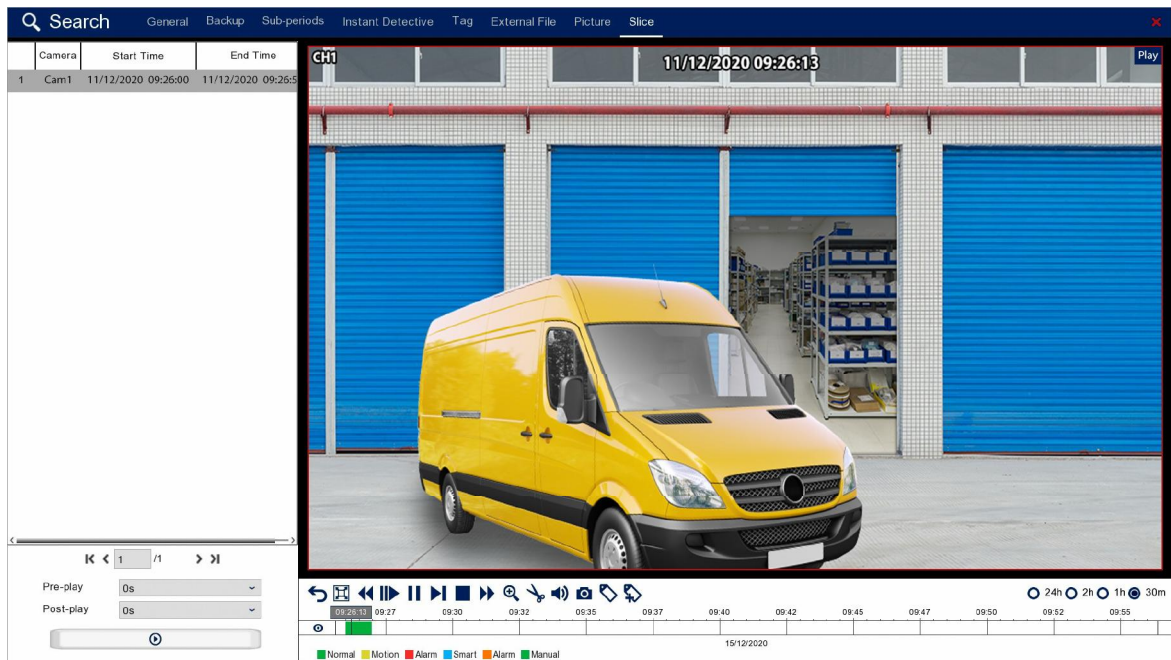

#### Playback Toolbar

For more information on using the playback controls see the [Playback Toolbar Explained](#)<sup>65</sup> section.

#### Pre And Post Play

The Pre-Play and Post-Play allows you to specify the period of time shown before and after the selected video slice so that you can view an entire incident. If a incident starts before the footage covered by the slice or finishes after the slice ends you can set the Pre-Play and Post-Play accordingly.

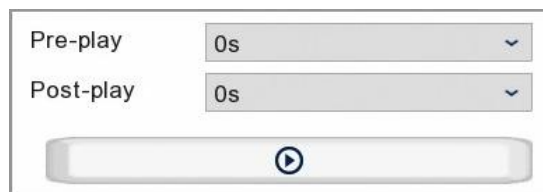

Using the drop-down lists you can set the Pre-Play and Post-Play times from 0 seconds up to 10 minutes.



Once you have set the Pre-Play and post-Play times click the **Play** button below the drop-down lists to start playback with the Pre-play and Post-Play time added to the video slice.



### **Saving Video Clips**

To backup video slices use the **Snipping Tool** from the toolbar as explained in the [Snipping Tool<sup>69</sup>](#) section.

## Main Menu



## Three clicks completes most actions

Every Zip recorder has our ultra easy to use Disc menu system. With its clear and simple layout, it's easy to navigate and find all the features the Zip recorder has to offer.

To access the main menu **right click** the mouse during live view and select **Main Menu** or press the **Menu** button on the front panel of the device.

From the Disc menu you can access all of the main sections of the menu system as well as the How To guides and Shutdown options.

- [Video Menu](#) <sup>113</sup>
- [Record Menu](#) <sup>198</sup>
- [Alarm Menu](#) <sup>218</sup>
- [Network Menu](#) <sup>241</sup>
- [Storage Menu](#) <sup>265</sup>
- [System Menu](#) <sup>273</sup>
- [How To Guides](#) <sup>322</sup>
- [Shutdown Options](#) <sup>321</sup>

## Video Menu

The Video menu is where you can manage your CCTV cameras connected to the Zip recorder.

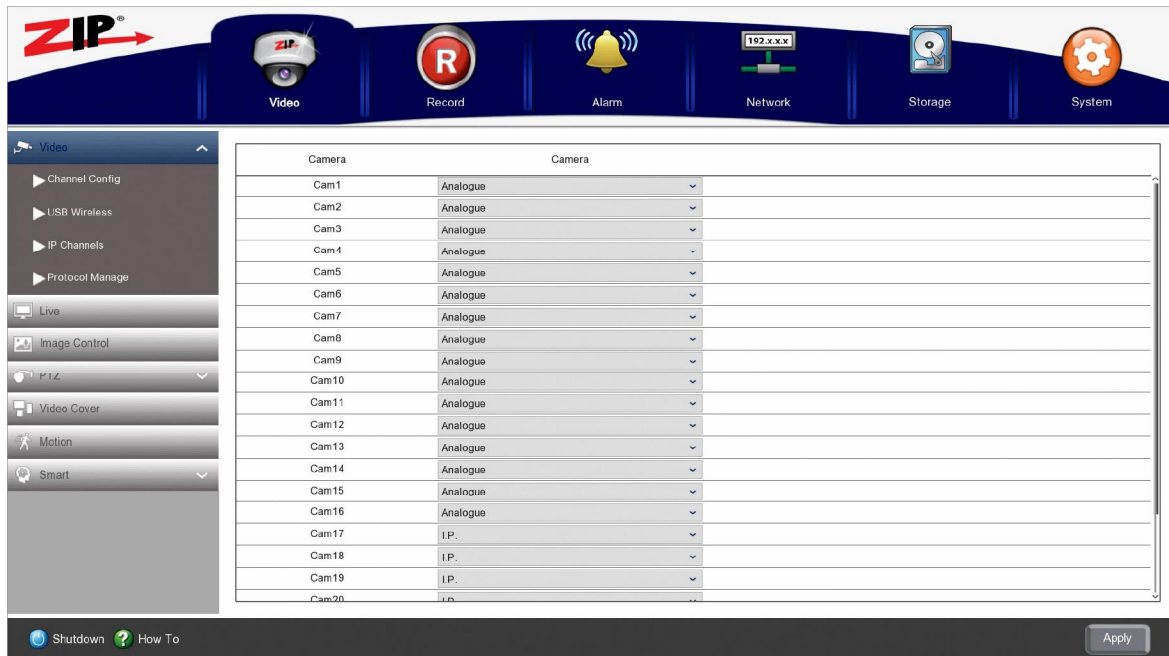

From the Video menu you can access the following sub-menus and features.

### Video

The [Video sub-menu](#)<sup>(114)</sup> is where you can configure all of your camera's settings.

- **Channel Config** - Set the camera type for each channel. Analogue, IP or USB Wireless.
- **USB Wireless**<sup>(115)</sup> - Allows you to setup the Zip Rapid Deploy wireless battery powered cameras.
- **IP Channels**<sup>(118)</sup> - Add IP cameras to the DVR and manage existing IP cameras.
- **Protocol Manage**<sup>(145)</sup> - Set custom RTSP links for streams from devices which don't connect automatically.

### Live

The [Live sub-menu](#)<sup>(147)</sup> allows you to configure the channel name as well as the channel information overlaid on the camera's image during live view and on recorded footage.

### Image Control

In the [Image Control sub-menu](#)<sup>(151)</sup> you can configure the image settings for compatible cameras such as Lens Flip, Back Light and Exposure.

## PTZ

The [PTZ sub-menu](#)<sup>(155)</sup> is where you can set the PTZ parameters for your cameras like the Protocol and Baudrate.

## Video Cover

You can setup privacy masking for each camera in the [Video Cover sub-menu](#)<sup>(157)</sup>.

## Motion

In the [Motion sub-menu](#)<sup>(159)</sup> you can setup and enable/disable Motion Detection for each camera.

## Smart

The [Smart sub-menu](#)<sup>(163)</sup> lets you configure, schedule and analyse Smart alarm features for compatible cameras.

- [PID](#)<sup>(163)</sup> - Perimeter Intrusion Detection.
- [LCD](#)<sup>(167)</sup> - Line Crossing Detection.
- [SOD](#)<sup>(171)</sup> - Stationary Object Detection.
- [PD](#)<sup>(175)</sup> - Pedestrian Detection.
- [FD](#)<sup>(180)</sup> - Face Detection.
- [CC](#)<sup>(186)</sup> - Cross Counting.
- [Sound Detection](#)<sup>(190)</sup>.
- [Lens Covered](#)<sup>(193)</sup>.
- [Schedule](#)<sup>(195)</sup>.
- [Intelligent Analysis](#)<sup>(197)</sup>.

## 9.1 Video Menu - Video

From the Video sub-menu inside the Video menu you can configure channel settings and IP camera settings.

### 9.1.1 Video Menu - Video - USB Wireless



You can manage your Zip Rapid Deploy wireless battery powered cameras in the USB Wireless sub-menu.

Camera	Channel Name	Pair State	Pool Recording	Camera Version	Battery	Pair	Activate	Switch
W Cam1	Main Gate	Paired	10 s	V1.01.051_5.3a	94%			ON
W Cam2	Side Gate	Paired	10 s	V1.01.051_5.3a	91%			ON
W Cam3	Entrance	Paired	10 s	V1.01.051_5.3a	87%			ON
W Cam4	Reception	Paired	10 s	V1.01.051_5.3a	98%			ON

## Pairing Cameras

Pairing the Zip wireless cameras is easy just follow these simple steps.

1. Connect the Zip Rapid Deploy USB wireless receiver to the recorder.
2. Switch up to 4 IP channels to USB Wireless as explained in the Channel Config sub-menu. 1 wireless camera channel will be made available in the USB Wireless sub-menu for each IP channel you have switched to USB Wireless.
3. To pair a Zip wireless camera to one of the wireless camera channels, press the pairing button on the back of the camera and then press the pair icon (blue camera) on the channel you want to assign the camera to.
4. A pairing timer will begin to countdown. Once the camera and receiver have found each other and successfully paired the timer will disappear. The Pair State for the selected wireless camera channel should now read Paired to show that the wireless camera is successfully connected to the recorder.

## Channel Name

To make identifying cameras easier you can assign a channel name to each wireless camera, for example: Main Gate. to do this just click inside the grey Channel Name field and [virtual keyboard](#)<sup>(31)</sup> will be displayed. Once you have entered the a camera name click **Apply** to save your changes.

## Pair State

The Pair State column shows if the allocated wireless channel has a camera paired to it or not. If a camera has been paired to the channel it will display "**Paired**". Likewise if the channel doesn't have a camera paired to it, it will display "**Not Paired**".

## Post Recording

The Post Recording time determines how long the channel records for after the last detected movement. This ensures entire incidents are recorded as the recorder will continuously capture footage as long as there is movement and will continue to record for the set Post Recording time after the movement has ended.

You can select the Post Recording time from the drop-down list. You have 3 options to choose from, 10 seconds, 20 seconds or 30 seconds.

## Camera Version

The Camera Version column shows the camera's firmware version.

## Battery

This shows the current battery charge level for each camera. You can keep track of how fast a battery's power is being use up and estimate how long a fully charged battery should last.

## Pair

The blue camera icon in the Pair column is the pair button used when pairing a camera to a USB wireless channel as explained above.

## Activate

You can manually activate a camera rather than waiting for a motion trigger by clicking the **blue Play button** in the Activate column.

## Switch

You can enable and disable cameras using the drop-down list in the Switch column. When a camera is set to **On** it will activate when motion is detected. You can set a camera to **Off** if it isn't required for a period of time and it will not activate or record therefore conserving battery life.

## Defaulting Settings

You can restore settings back to their default value by clicking the **Default** button.

## Saving Changes

Once you have configured your cameras click **Apply** to save your new settings.

### 9.1.2 Video Menu - Video - IP Channels

From the video sub-menu you can manage the IP cameras connected to your recorder in the IP Channels sub-menu.

The screenshot shows the 'IP Channels' configuration page in the ZIP NVR web interface. The top navigation bar includes icons for Video, Record, Alarm, Network, Storage, and System. The left sidebar has a 'Video' menu with sub-items: Channel Config, USB Wireless, IP Channels (selected), Protocol Manage, Live, Image Control, 12, Video Cover, Motion, and Smart. The main content area features two tables of camera data.

No.	Edit	IP Address/Domain	Port	Manufacturer	Device Type	MAC Address	Software Version
1	[edit]	192.168.0.27	8240	Zip	IPCZIP920B	38-B1-9E-80-01-4B	V6.21.5.0_190725
2	[edit]	192.168.0.41	8240	Zip	ZIP108	38-B1-9E-80-03-2C	V6.21.5.0_190725
3	[edit]	192.168.0.30	8240	Zip	IPCZIP815W	38-B1-9E-80-01-1E	V6.21.5.0_190725
4	[edit]	192.168.0.15	8240	Zip	IPCZIP880B	38-B1-9E-80-05-5B	V6.21.5.0_190725
5	[edit]	192.168.0.34	8240	Zip	ZIP216	38-B1-9E-80-02-3A	V6.21.5.0_190725
6	[edit]	192.168.0.12	8240	Zip	ZIP204	38-B1-9E-80-04-5C	V6.21.5.0_190725
7	[edit]	192.168.0.26	8240	Zip	IPCZIP930W	38-B1-9E-80-07-2D	V6.21.5.0_190725
8	[edit]	192.168.0.33	8240	Zip	IPCZIPS30W	38-B1-9E-80-05-1E	V6.21.5.0_190725

Buttons: Search, Add, Add All

Camera	Edit	State	IP Address/Domain	Subnet Mask	Port	Manufacturer	Device Type	Protocol	MAC Address	Software Version
IP Cam1	[edit]	[state]	192.168.0.71	255.255.255.0	8240	Zip	IPCZIP880W	Onvif_enhanced	38-B1-9E-80-17-41	V6.21.5.0_190725
IP Cam2	[edit]	[state]	192.168.0.66	255.255.255.0	8240	Zip	IPCZIP800B	Onvif_enhanced	38-B1-9E-80-12-1A	V6.21.5.0_190725
IP Cam3	[+]									
IP Cam4	[+]									
IP Cam5	[+]									
IP Cam6	[+]									
IP Cam7	[+]									

Buttons: Auto Assign IP to Camera(s), Delete Camera, Default Password

Total Band Width: 32Mbps, Used Band Width: 8Mbps

Shut down ? How To



### 9.1.2.1 Video Menu - Video - IP Channels - Connecting IP Cameras To An NVR

When adding IP cameras to an NVR the way in which they are connected depends on what type of NVR you have, PoE or Non-PoE.

#### Connecting Cameras To A Non-PoE NVR Via A Switch

When connecting cameras to a non-PoE NVR, they are first connected to a network switch which is in-turn connected to the NVR as shown below. The cameras can be powered via a PoE switch or powered locally with a 12V DC PSU if you are using a non-PoE switch.

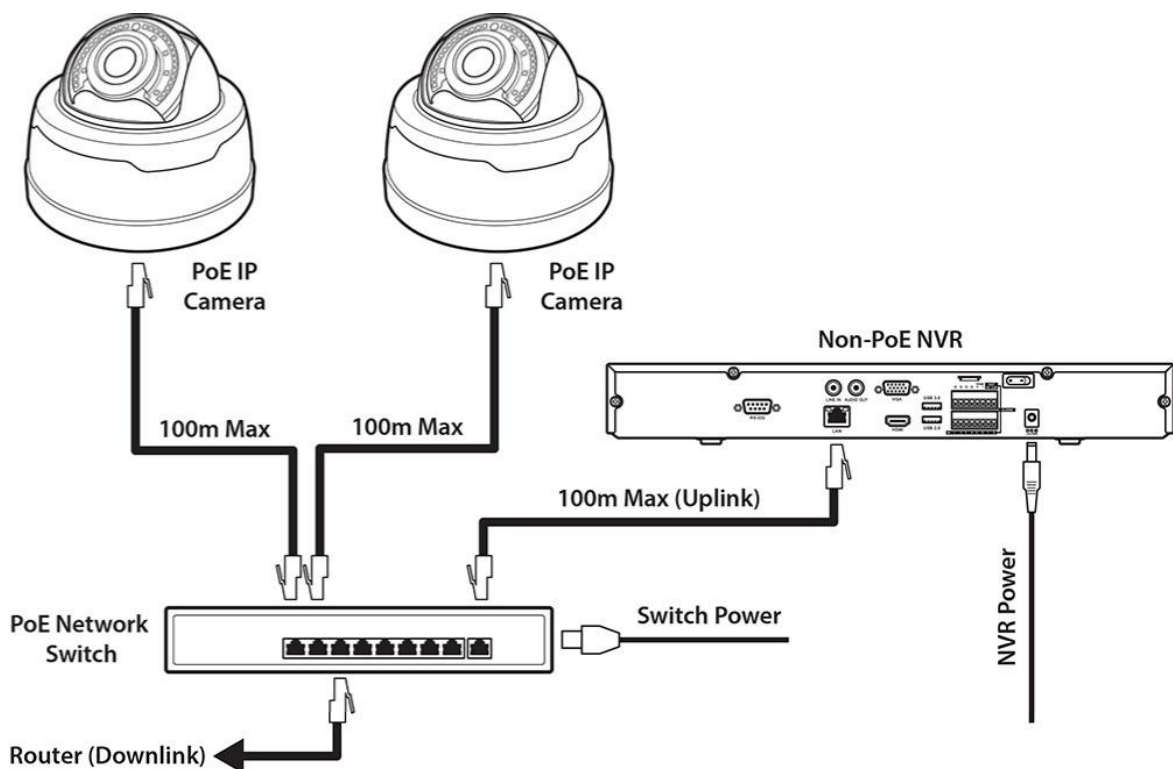

Once connected you can add your cameras to the NVR by following the simple steps in the [Adding Zip IP Cameras](#)<sup>(123)</sup> section.

#### Connecting Cameras To A PoE NVR Via A Switch

In some cases you may wish or need to use a network switch on a PoE NVR. You may have a group of cameras with a difficult cable path to the NVR. These cameras could be connected to a local switch and the switch can then be cabled back to the NVR so you only have to run 1 cable.

You would also need to use a switch on larger installs where you have a 32Ch NVR. These models have 16 PoE channels with their own ports and 16 Non-PoE channels which need connecting via a network.

In these instances you would use a switch connected to the NVRs PoE ports as shown below. Again the cameras can be powered via a PoE switch or powered locally with a 12V DC PSU if you are using a non-PoE switch.

### Expert Advice - Easy installation

For the easiest installation we recommend that you connect all cameras, including the cameras which will be connected via the switch, to one of the PoE ports on the NVR using a short network lead before installation.

By doing this the NVR will auto-configure the camera and add it to one of the IP channels. You can then disconnect the camera and the NVR will remember the camera's settings. You will then need to set the **Switch Mode** to **Manual Mode** in the [IP Channels](#)<sup>(118)</sup> sub-menu for any cameras which will be re-connected via the external PoE switch.

<input type="checkbox"/>	Camera	Switch Mode	PoE Mode	Edit	State
PoE	IP Cam1	Auto Mode	Auto Mode		
PoE	IP Cam2	Auto Mode	Manual Mode		
PoE	IP Cam3	Auto Mode	Auto		
PoE	IP Cam4	Auto Mode	Auto		
PoE	IP Cam5	Auto Mode	Auto		
PoE	IP Cam6	Auto Mode	Auto		

If you don't set the switch mode to **Manual** the NVR will try to auto assign the cameras IP address again when the cameras are reconnected via the switch. However, as multiple cameras are now connected through one switch they will all be assigned the same IP address. Having multiple cameras with the same IP address will cause an IP conflict and the cameras will not behave as they should.

Once the switch mode has been set to **Manual** you can connect the camera via the external switch. The NVR will recognise the camera and reconnect automatically.

If you don't do this process and decide to just connect the cameras to the switch then the cameras will need to be added manually. This can be done by following the simple steps in the [Adding Zip IP Cameras](#)<sup>(123)</sup> section.

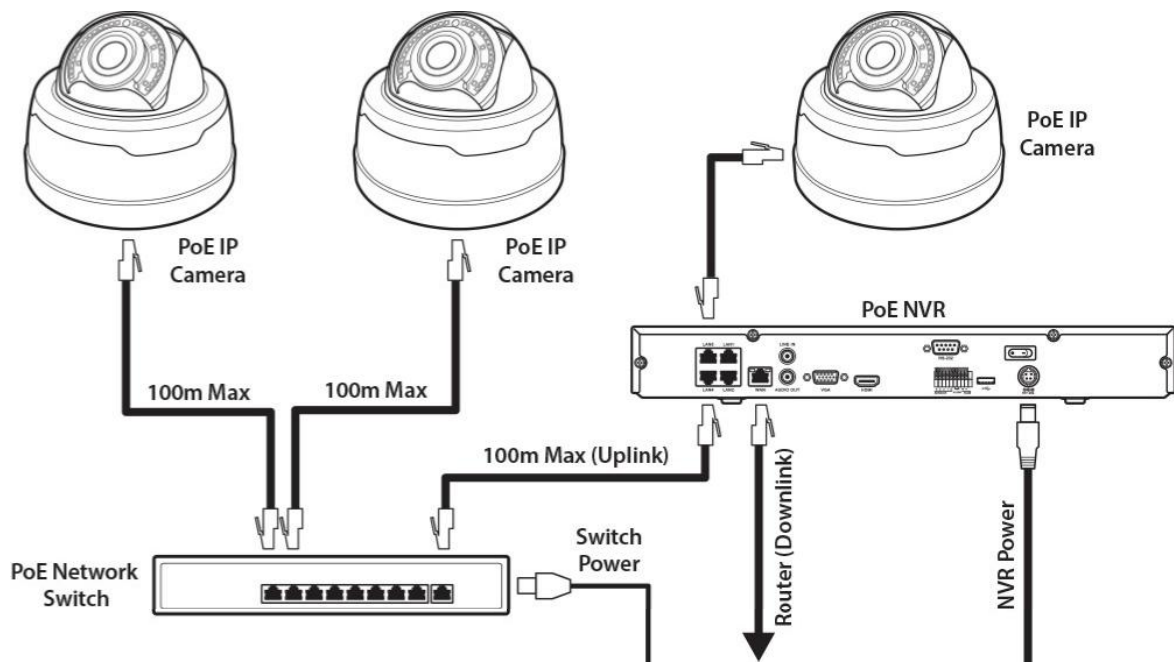

We would usually recommend connecting the switch to the last PoE port to make things easier. This leaves the first PoE ports free for PoE cameras to be connected directly to the NVR.

When you are connecting a large number of cameras to a larger switch with 2 uplinks, we recommend connecting both uplinks to the last 2 PoE ports on the NVR. This will allow both uplinks to share the bandwidth of the cameras.

### Connecting Cameras To A PoE NVR

The easiest way of connecting Zip IP cameras is to use a Zip PoE NVR as the cameras are automatically configured and added to NVR for you. When connecting PoE cameras to a PoE NVR they are connected directly to one of the PoE ports on the NVR as shown below. Non-PoE cameras can also be added in this way with the use of PoE splitters.

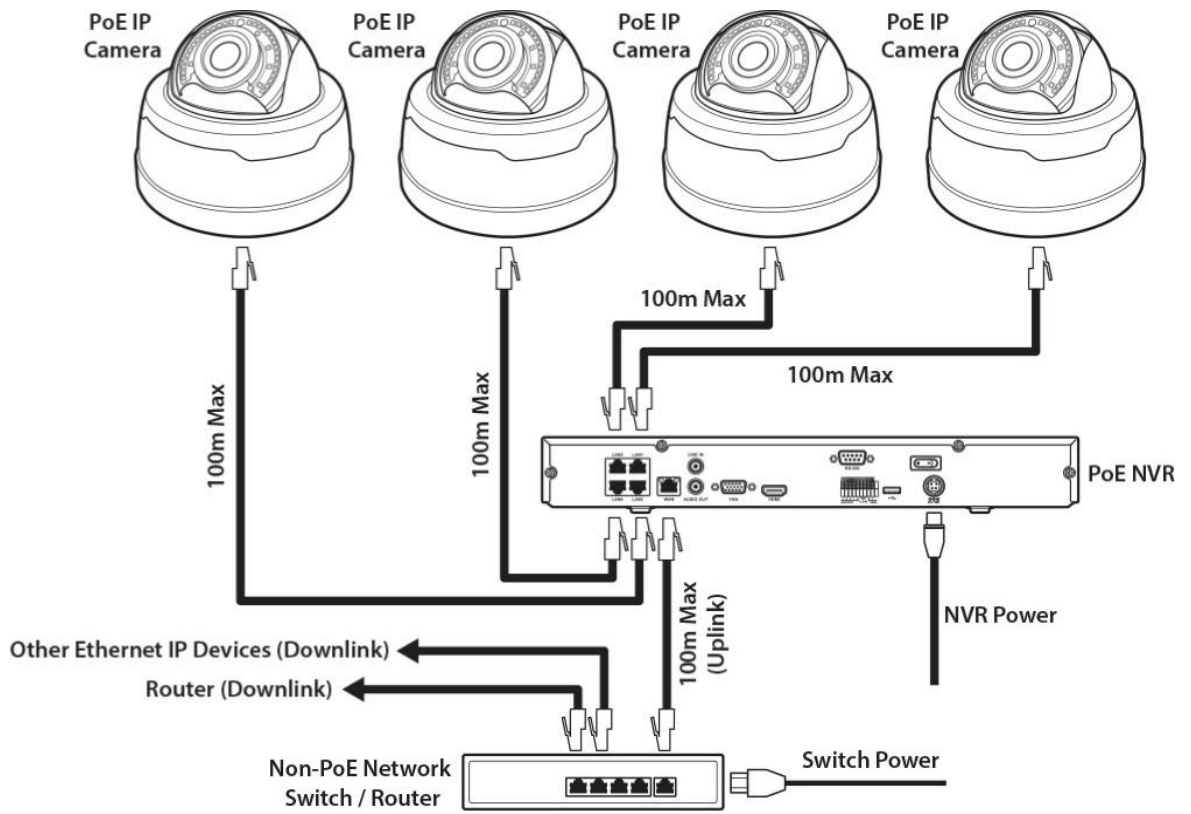

### 9.1.2.2 Video Menu - Video - IP Channels - Adding Zip IP Cameras

We've made it super easy to add Zip IP cameras to your Zip recorder. With a few clicks you can automatically assign IP addresses to your cameras and add them to the available channels.

Once your cameras have been connected to your recorder and your recorder has been networked go to the [IP Channels](#) <sup>(118)</sup> sub-menu.

<input type="checkbox"/>	No.	Edit	IP Address/Domain	Port	Manufacturer	Device Type	MAC Address	Software Version
<input type="checkbox"/>	1		192.168.0.27	8240	Zip	IPCZIP920B	38-B1-9E-B0-01-4B	V6.21.5.0_190725
<input type="checkbox"/>	2		192.168.0.41	8240	Zip	ZIP108	38-B1-9E-B0-03-2C	V6.21.5.0_190725
<input type="checkbox"/>	3		192.168.0.30	8240	Zip	IPCZIP815W	38-B1-9E-B0-01-1E	V6.21.5.0_190725
<input type="checkbox"/>	4		192.168.0.15	8240	Zip	IPCZIP880B	38-B1-9E-B0-05-5B	V6.21.5.0_190725
<input type="checkbox"/>	5		192.168.0.34	8240	Zip	ZIP216	38-B1-9E-B0-02-3A	V6.21.5.0_190725
<input type="checkbox"/>	6		192.168.0.12	8240	Zip	ZIP204	38-B1-9E-B0-04-5C	V6.21.5.0_190725
<input type="checkbox"/>	7		192.168.0.26	8240	Zip	IPCZIP930W	38-B1-9E-B0-07-2D	V6.21.5.0_190725
<input type="checkbox"/>	8		192.168.0.33	8240	Zip	IPCZIP530W	38-B1-9E-B0-05-1E	V6.21.5.0_190725

Search   Add   Add All

### Automatically Assigning IP Addresses

After a few seconds the list at the top of the page will be populated with IP cameras discovered on the same network as the recorder.

When the list has been populated click the **Auto Assign IP to Camera(s)** button at the bottom of the screen.

Auto Assign IP to Camera(s)

This will display the **Auto Assign IP to Camera(s)** window.

### Username & Password

Auto Assign IP to Camera(s)
✕

Username

Password   Show Password

In this window you enter the Username and Password of the camera(s) you want to add to your recorder. When you click **OK** the recorder will assign an IP address to all cameras which use those credentials and add those cameras to the recorder.

Zip IP cameras all have the default **Username: admin** and **Password: 777777**.

### 9.1.2.3 Video Menu - Video - IP Channels - Searching For Cameras

When you enter the IP Channels sub-menu the recorder will automatically start searching for compatible cameras and display them in the list at the top of the screen.

<input type="checkbox"/>	No.	Edit	IP Address/Domain ^	Port	Manufacturer	Device Type	MAC Address	Software Version
<input type="checkbox"/>	1		192.168.0.27	8240	Zip	IPCZIP920B	38-B1-9E-B0-01-4B	V6.21.5.0_190725
<input type="checkbox"/>	2		192.168.0.41	8240	Zip	ZIP108	38-B1-9E-B0-03-2C	V6.21.5.0_190725
<input type="checkbox"/>	3		192.168.0.30	8240	Zip	IPCZIP815W	38-B1-9E-B0-01-1E	V6.21.5.0_190725
<input type="checkbox"/>	4		192.168.0.15	8240	Zip	IPCZIP880B	38-B1-9E-B0-05-5B	V6.21.5.0_190725
<input type="checkbox"/>	5		192.168.0.34	8240	Zip	ZIP216	38-B1-9E-B0-02-3A	V6.21.5.0_190725
<input type="checkbox"/>	6		192.168.0.12	8240	Zip	ZIP204	38-B1-9E-B0-04-5C	V6.21.5.0_190725
<input type="checkbox"/>	7		192.168.0.26	8240	Zip	IPCZIP930W	38-B1-9E-B0-07-2D	V6.21.5.0_190725
<input type="checkbox"/>	8		192.168.0.33	8240	Zip	IPCZIP930W	38-B1-9E-B0-05-1E	V6.21.5.0_190725

Search Add Add All

If the device you are looking for isn't discovered or was connected after you entered the IP Channel sub-menu you can click the **Search** button to look for new devices.

You can also search for and configure IP cameras via a PC on the same network before adding them to the DVR. The [Zip Finder](#) software is a free, powerful, easy to use tool for setting up IP cameras following the same principles as explained in the [IP Camera Settings](#)<sup>(127)</sup> section.

#### Edit

The Edit column will show one of two icons.

Clicking the **Edit** icon will display the [Modify IP Camera Settings](#)<sup>(127)</sup> window where you can edit the camera's IP settings before adding it to the recorder. Some settings such as the camera's IP Address can only be modified before the camera is added to the recorder. This is usually only required for 3rd party cameras as you can auto assign IP addresses to Zip cameras as shown in the [Adding Zip IP Cameras](#)<sup>(123)</sup> section.

The **Plus** icon is displayed instead of the **Edit** icon when another recorder is discovered on the same network. Clicking the **Plus** icon will display the channels of the recorder and allow you to add those channels as IP cameras as explained in the [Adding Cameras From A Zip Recorder](#)<sup>(135)</sup> section.

#### IP Address/Domain

Shows the IP Address of device.

#### Port

Shows the port assigned to the device.

#### Manufacturer

Some devices will also display the manufacturers name in the Manufacturer column.

### Device Type

This show basic information to help you identify the device. For Zip devices the model number will be displayed but this may differ for other manufacturers.

### MAC Address

The Mac address is the unique ID of the device. For Zip devices this will always start 38-B1-9E-B0 followed by 2 pairs of unique digits.

### Software Version

The current firmware version of the device will be displayed in this column.

Once your cameras have been discovered you will need to configure them as explained in the [IP Camera Settings](#)<sup>(127)</sup> section.



### 9.1.2.4 Video Menu - Video - IP Channels - IP Camera Settings

The Modify IP Camera Settings window is displayed when you click the Edit button  in the IP Channels sub-menu. This is an easy way to configure the settings on the IP camera itself prior to adding the camera to your recorder. Some settings may be locked for editing depending on where you accessed the window from.

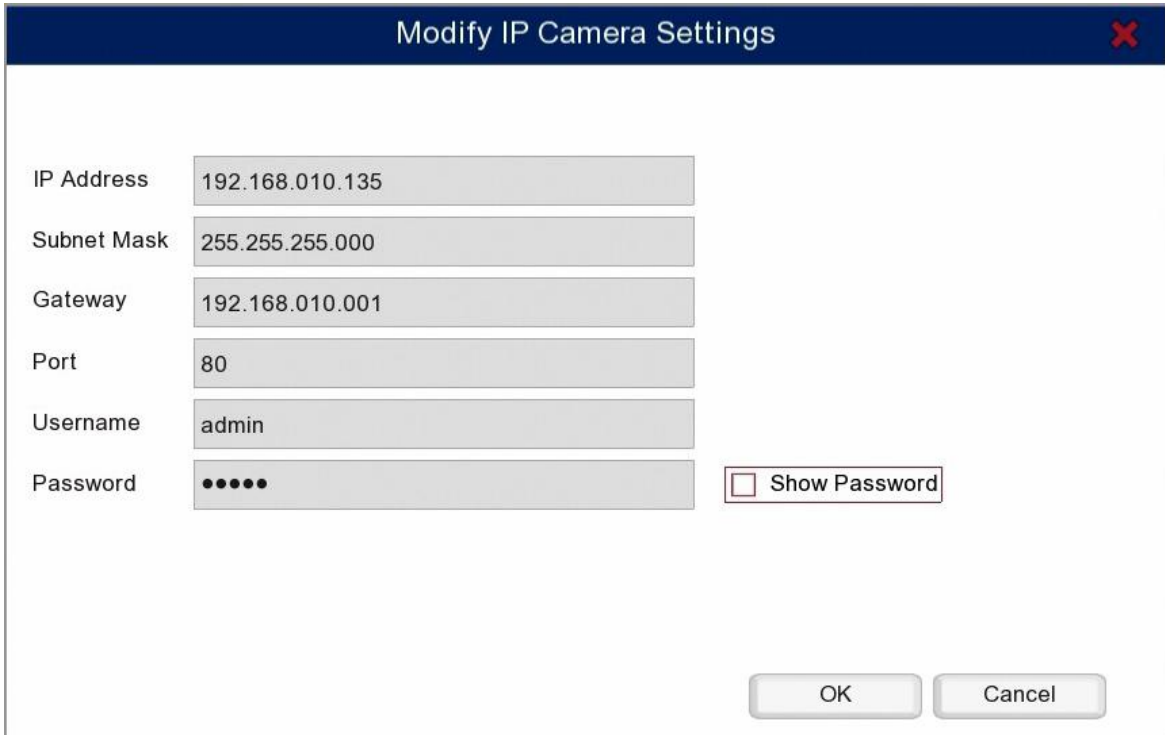

IP Address	192.168.010.135
Subnet Mask	255.255.255.000
Gateway	192.168.010.001
Port	80
Username	admin
Password	••••• <input type="checkbox"/> Show Password

OK Cancel

#### IP Address

When setting an IP address for the camera it must be in the same range as the IP address of the recorder you plan to add it to and it must be unique.

This means the first 3 segments of the address must match the recorders e.g. 192.168.010. The last segment must be unique to the device. If you accidentally duplicate the IP address of another device this will cause an IP Conflict and neither device will function properly.

If you do not know the recorder's IP address this can be found in the [Network](#)<sup>(241)</sup> sub-menu.

#### Subnet Mask

By default the Subnet Mask will be set to 255.255.255.000. We strongly recommend leaving this as is unless you are an IT professional.

#### Port

The port is usually preset in the camera and can usually be left as the default port. On Zip IP cameras this will be 8240.

## Username

The Username field allows you to change the camera's username if required, however you are usually OK to leave this as the default.

The username will differ depending on the camera and the manufacture. This can usually be found in the documentation supplied with the camera.

For Zip IP cameras the default username is **admin**.

## Password

The Password field allows you to change the camera's password if required, however you are usually OK to leave this as the default.

The password will differ depending on the camera and the manufacture. This can usually be found in the documentation supplied with the camera.

For Zip IP cameras the default password is **777777**.

When you have entered all of the relevant settings click **OK** to save your settings and exit the IP Camera Settings window. When you have configured all of your cameras you can add the to the recorder as show in the [Adding IP Single Cameras](#)<sup>(131)</sup> section.

### 9.1.2.5 Video Menu - Video - IP Channels - Default Passwords

If you plan on adding multiple cameras from the same manufacturer which share the same logon details setting up default passwords can be a real time saver. Once setup you can choose one of you pre-saved username and password combinations when adding cameras rather than having to type the same information in over and over again.

Onvif\_enhanced and Onvif\_Standard are used when adding IP cameras to the recorder. Onvif\_enhanced is already configured Zip IP cameras so you will only need to change this if your are **not** using Zip cameras. The Custom protocols are used when [adding cameras from another brand of recorder](#)<sup>(140)</sup> such as the Alien DVR.

### Setting Up Default Usernames & Passwords

To setup default username and password combinations click the Default password button in the **IP Channels** sub-menu.

Default Password

This will display the following window

Set The Protocol Default Password
✖

Protocol	Username	Password
Onvif_enhanced	admin	••••••
Onvif_standard	admin	••••••
Custom 1	admin	••••••
Custom 2	admin	••••••
Custom 3	admin	••••••
Custom 4	admin	••••~
Custom 5	admin	••••~
Custom 6	admin	••••~
Custom 7	admin	••••~
Custom 8	admin	••••~
Custom 9	admin	••••~

You can assign default usernames and passwords to each protocol by clicking in the desired field then using the virtual keyboard to input the logon credentials. For more information on configuring protocols see the [Protocol Manage](#)<sup>(145)</sup> section.

By default the Onvif\_enhanced credentials are configured for Zip IP cameras with the username: **admin** and password: **777777**. All other protocols are set as username: **admin** and password: **admin** by default.

To save your changes click the **Save** button. To exit the window click **Cancel** however any unsaved changes will be lost. You can also restore the username and password combinations to the default settings using the **Default** button.

### 9.1.2.6 Video Menu - Video - IP Channels - Adding Single IP Cameras

Once your IP cameras have been configured as explained in the [IP Camera Settings](#)<sup>(127)</sup> section you're ready to add them to your recorder. You can add single cameras as explained here or you [add multiple cameras](#)<sup>(133)</sup> at the same time.

#### Adding Single Cameras

To add a single camera you can select the camera from the list and click the **Add** button to display the **Add IP Camera** window. Alternatively you can click the **Add** button and then select your camera once inside the **Add IP Camera** window.

Add IP Camera
✕

No.	IP Address/Domain	Port	Manufacturer	Device Type	MAC Address	Software
1	192.168.0.27	8240	ZIP	IPCZIP920B	38-B1-9E-B0-01-4B	V6.21
2	192.168.0.41	8240	ZIP	ZIP108	38-B1-9E-B0-03-2C	V6.21
3	192.168.0.30	8240	ZIP	IPCZIP815W	38-B1-9E-B0-01-1E	V6.21
4	192.168.0.15	8240	ZIP	IPCZIP880B	38-B1-9E-B0-05-5B	V6.21
5	192.168.0.34	8240	ZIP	ZIP216	38-B1-9E-B0-02-3A	V6.21
6	192.168.0.12	8240	ZIP	ZIP204	38-B1-9E-B0-04-5C	V6.21
7	192.168.0.26	8240	ZIP	IPCZIP930W	38-B1-9E-B0-07-2D	V6.21
8	192.168.0.33	8240	ZIP	IPCZIP530W	38-B1-9E-B0-05-1F	V6.21
9	192.168.0.66	8240	ZIP	IPCZIP920W	38-B1-9E-B0-A2-11	V6.21
10	192.168.0.91	8240	ZIP	IPCZIP800B	38-B1-9E-B0-B4-C3	V6.21
11	192.168.0.52	8240	ZIP	IPCZIP920B	38-B1-9E-B0-A2-11	V6.21

IP Address/Domain:

Camera Name:

Port:

Protocol:  ▼

Username:

Password:   Show Password

Bind channel:  ▼

In the bottom half of the window you will see editable IP settings. It is important to note that these are **not** the camera's IP settings, these are the settings the recorder uses to look for the camera.

Therefore these settings have to match with the camera's otherwise the recorder will not be able to connect to the camera. To make things easier, when you select a camera these fields are automatically populated for you.

If the camera you want to add is not displayed in the list you can click the **Search** button. The recorder will then search for devices on the network and refresh the list.

### IP Address/Domain

This is the IP address the recorder will connect to. We recommend leaving this as it is once you have selected your camera.

### Camera Name

You can enter a name up to 8 characters long for your camera. This will be overlaid onto the camera's image during live view and on recorded footage.

### Port

This is the port in the router where the recorder will look for the camera. We recommend leaving this as it is once you have selected your camera.

### Protocol

The protocol should be detected and set automatically and in most cases you can leave this as it is. For more information on configuring protocols see the [Protocol Manage](#)<sup>(145)</sup> section.

### Username & Password

You can manually enter the Username and Password if required so that they match the camera. For Zip cameras you can leave them as they are unless you have changed the default username and password in the camera itself.

The username and password fields will be populated automatically based on which protocol is selected. You can change the username and password assigned to each protocol in the [Default Password](#)<sup>(131)</sup> screen by clicking the **Default Password** button.

### Bind Channel

The Bind Channel drop-down list allows you to choose which channel the camera is assigned to on the recorder.

Once you are happy with the settings click **Add** to add the camera to the recorder. To exit without adding the camera to the recorder click **Cancel**.

### 9.1.2.7 Video Menu - Video - IP Channels - Adding Multiple IP Cameras

If you plan on adding multiple IP cameras which share the same logon credentials you can save time by adding them all at once. You can either add a selection of the available cameras or you can choose to add all available cameras.

#### Adding Multiple Cameras

<input type="checkbox"/>	No.	Edit	IP Address/Domain	Port	Manufacturer	Device Type	MAC Address	Software Version
<input checked="" type="checkbox"/>	1		192.168.0.27	8240	Zip	IPCZIP920B	38-B1-9E-B0-01-4B	V6.21.5.0_190725
<input type="checkbox"/>	2		192.168.0.41	8240	Zip	ZIP108	38-B1-9E-B0-03-2C	V6.21.5.0_190725
<input checked="" type="checkbox"/>	3		192.168.0.30	8240	Zip	IPCZIP815W	38-B1-9E-B0-01-1E	V6.21.5.0_190725
<input checked="" type="checkbox"/>	4		192.168.0.15	8240	Zip	IPCZIP880B	38-B1-9E-B0-05-5B	V6.21.5.0_190725
<input type="checkbox"/>	5		192.168.0.34	8240	Zip	ZIP216	38-B1-9E-B0-02-3A	V6.21.5.0_190725
<input type="checkbox"/>	6		192.168.0.12	8240	Zip	ZIP204	38-B1-9E-B0-04-5C	V6.21.5.0_190725
<input type="checkbox"/>	7		192.168.0.26	8240	Zip	IPCZIP930W	38-B1-9E-B0-07-2D	V6.21.5.0_190725
<input type="checkbox"/>	8		192.168.0.33	8240	Zip	IPCZIP930W	38-B1-9E-B0-05-1E	V6.21.5.0_190725

Search   Add   Add All

To add a selection of cameras simply tick the check box next the the cameras you want to add in the search result window and click the **Add** button. Alternatively, to add all available cameras click the **Add All** button. This will display the **Add IP Camera** window.

Add IP Camera
✖

Port	<input type="text" value="80"/>	<input checked="" type="checkbox"/>	Auto
Protocol	<input type="text" value="Onvif_standard"/>	<input checked="" type="checkbox"/>	Auto
Username	<input type="text" value="Default"/>		
Password	<input type="text" value="Default"/>	<input type="checkbox"/>	Show Password

#### Port

This is the port in the router where the recorder will look for the camera. By default this will be set as **Auto** and it is recommended that you leave it as such. When set to **Auto** the recorder will use the port which has been set in the camera. To specify a port you will need to untick **Auto**.

## Protocol

The protocol is set as **Auto** by default and it is recommended that you leave it as such. When set to **Auto** the camera's protocol will be detected and set automatically. For more information on configuring protocols see the [Protocol Manage](#) <sup>(145)</sup> section.

## Username & Password

When left as **Default** the username and password will be populated automatically based on which protocol is detected for each camera. You can change the username and password assigned to each protocol in the [Default Password](#) <sup>(131)</sup> screen.

You can manually enter the Username and Password if required. However, when you do this the recorder will attempt to connect to each camera you are adding with those credentials.

Once you are happy with the settings click **Add** to add the cameras to the recorder. To exit without adding the cameras to the recorder click **Cancel**.

***Note:** If you are trying to add more cameras than there are channels available you will get a message saying "No available channels to add more cameras". When you see this message all available channels will have a camera added to them but the leftover cameras will not be added to the recorder.*



### 9.1.2.8 Video Menu - Video - IP Channels - Adding Cameras From A Zip Recorder

You can add cameras from other Zip DVRs and NVRs as IP cameras as long as both recorders are on the same network. You can add single cameras as explained here or you [add multiple cameras](#)<sup>138</sup> at the same time.

#### Choosing A Camera From Another Zip Recorder

Recorders will show in the found IP device list similar to how your IP cameras appear. The main difference you will see is that recorders have a **Plus** icon in the **Edit** field rather than an **Edit** icon.

<input type="checkbox"/>	No.	Edit	IP Address/Domain	Port	Manufacturer	Device Type	MAC Address	Software Version																								
<input checked="" type="checkbox"/>	1	<input type="checkbox"/> <table border="1"> <tr> <td>1</td><td>2</td><td>3</td><td>4</td><td>5</td><td>6</td><td>7</td><td>8</td> </tr> <tr> <td>9</td><td>10</td><td>11</td><td>12</td><td>13</td><td>14</td><td>15</td><td>16</td> </tr> <tr> <td>17</td><td>18</td><td>19</td><td>20</td><td>21</td><td>22</td><td>23</td><td>24</td> </tr> </table>	1	2	3	4	5	6	7	8	9	10	11	12	13	14	15	16	17	18	19	20	21	22	23	24	192.168.0.27	8240	Zip	XTRA016	38-B1-9E-B0-01-4B	V6.21.5.0_190725
1	2	3	4	5	6	7	8																									
9	10	11	12	13	14	15	16																									
17	18	19	20	21	22	23	24																									
<input type="checkbox"/>	2		192.168.0.41	8240	Zip	IPCZIP920B	38-B1-9E-B0-03-2C	V6.21.5.0_190725																								
<input type="checkbox"/>	3		192.168.0.30	8240	Zip	IPCZIP815W	38-B1-9E-B0-01-1E	V6.21.5.0_190725																								

Search Add Add All

Tick the check box in the first column to select your recorder then click the **Plus** icon to expand the recorder and display the available channels. Select your camera and click the **Add** button to display the **Add IP Camera** window. Alternatively you can click the **Add** button and then select your recorder and camera once inside **the Add IP Camera** window.

Add IP Camera ✕

No.	IP Address/Domain	Port	Manufacturer	Device Type	MAC Address	Software
1	192.168.0.27	8240	ZIP	XTRA016	38-B1-9E-B0-01-4B	V6.21
2	192.168.0.41	8240	ZIP	IPCZIP920B	38-B1-9E-B0-03-2C	V6.21
3	192.168.0.30	8240	ZIP	IPCZIP815W	38-B1-9E-B0-01-1E	V6.21
4	192.168.0.15	8240	ZIP	IPCZIP880B	38-B1-9E-B0-05-5B	V6.21
5	192.168.0.34	8240	ZIP	ZIP216	38-B1-9E-B0-02-3A	V6.21
6	192.168.0.12	8240	ZIP	ZIP204	38-B1-9E-B0-04-5C	V6.21
7	192.168.0.26	8240	ZIP	IPCZIP930W	38-B1-9E-B0-07-2D	V6.21
8	192.168.0.33	8240	ZIP	IPCZIP530W	38-B1-9E-B0-05-1F	V6.21
9	192.168.0.66	8240	ZIP	IPCZIP920W	38-B1-9E-B0-A2-11	V6.21
10	192.168.0.91	8240	ZIP	IPCZIP800B	38-B1-9E-B0-B4-C3	V6.21
11	192.168.0.52	8240	ZIP	IPCZIP820B	38-B1-9E-B0-A2-11	V6.21

IP Address/Domain:

Camera Name:

Port:

Protocol:  ▼

Username:

Password:   Show Password

Bind channel:  ▼

### Target Recorder Settings

In the bottom half of the window you will see editable settings. It is important to note that this will **not** the change any settings on the recorder you are attempting to connect to, these are just the credentials used to connect to the recorder and camera. Therefore these settings have to match those of the target recorder otherwise you will not be able to connect to the camera. To make things easier, when you select select a recorder some fields are automatically populated for you.

#### IP Address/Domain

This is the IP address the recorder will try connect to so this needs to be the IP address of the target recorder.

### Camera Name

You can enter a name up to 8 characters long for your camera. This will be overlaid onto the camera's image during live view and on recorded footage.

### Port

This needs to be the port in the router that the target recorder is assigned to. This will be filled in automatically however you may need to check the settings on the target recorder to see what this is set to.

### Protocol

The protocol should be detected and set automatically and in most cases you can leave this as it is. For more information on configuring protocols see the [Protocol Manage](#)<sup>(145)</sup> section.

### Username & Password

These need to be the logon credentials for the admin account of the target recorder.

### Bind Channel

The Bind Channel drop-down list allows you to choose which channel the camera is assigned to on the recorder.

Once you are happy with the settings click **Add** to add the camera to the recorder. To exit without adding the camera to the recorder click **Cancel**.

### 9.1.2.9 Video Menu - Video - IP Channels - Adding Multiple Cameras From A Zip Recorder

You can add multiple cameras at the same time from another Zip DVR or NVR as long as both recorders are on the same network. These cameras are added as IP cameras and can be viewed and recorded just like any other camera.

#### Choosing Cameras From Another Zip Recorder

Recorders will show in the found IP device list similar to how your IP cameras appear. The main difference you will see is that recorders have a **Plus** icon in the **Edit** field rather than an **Edit** icon.

<input type="checkbox"/>	No.	Edit	IP Address/Domain	Port	Manufacturer	Device Type	MAC Address	Software Version																								
<input checked="" type="checkbox"/>	1	<input type="checkbox"/> <table border="1"> <tr><td>1</td><td>2</td><td>3</td><td>4</td><td>5</td><td>6</td><td>7</td><td>8</td></tr> <tr><td>9</td><td>10</td><td>11</td><td>12</td><td>13</td><td>14</td><td>15</td><td>16</td></tr> <tr><td>17</td><td>18</td><td>19</td><td>20</td><td>21</td><td>22</td><td>23</td><td>24</td></tr> </table>	1	2	3	4	5	6	7	8	9	10	11	12	13	14	15	16	17	18	19	20	21	22	23	24	192.168.0.27	8240	Zip	XTRA016	38-B1-9E-B0-01-4B	V6.21.5.0_190725
1	2	3	4	5	6	7	8																									
9	10	11	12	13	14	15	16																									
17	18	19	20	21	22	23	24																									
<input type="checkbox"/>	2		192.168.0.41	8240	Zip	IPCZIP920B	38-B1-9E-B0-03-2C	V6.21.5.0_190725																								
<input type="checkbox"/>	3		192.168.0.30	8240	Zip	IPCZIP815W	38-B1-9E-B0-01-1E	V6.21.5.0_190725																								

Search Add Add All

To add cameras simply tick the check box in the first column to select your recorder then click the **Plus** icon to expand the recorder and display the available channels. Select the channels you want to add and click the **Add** button to display the **Add IP Camera** window. You can select all cameras by ticking the small check box to the left camera 1. If you are only adding 1 camera see the [Adding Cameras From A Zip Recorder](#)<sup>(135)</sup> section.

Add IP Camera
✖

Port	<input type="text" value="80"/>	<input checked="" type="checkbox"/> Auto
Protocol	<input type="text" value="Onvif_standard"/>	<input checked="" type="checkbox"/> Auto
Username	<input type="text" value="Default"/>	
Password	<input type="text" value="Default"/>	<input type="checkbox"/> Show Password

## Target Recorder Settings

In the **Add IP Camera** window you will see a few editable settings, these are the credentials used to connect to the target recorder and camera. These settings have to match those of the target recorder otherwise you will not be able to connect to the cameras.

### Port

This needs to be the port in the router that the target recorder is assigned to. This will be filled in automatically however you may need to check the settings on the target recorder to see what this should be.

### Protocol

The protocol should be detected and set automatically and in most cases you can leave this as it is. For more information on configuring protocols see the [Protocol Manage](#)<sup>(145)</sup> section.

### Username & Password

These need to be the logon credentials for the admin account of the target recorder.

Once you are happy with the settings click **Add** to add the cameras to the recorder. To exit without adding the cameras to the recorder click **Cancel**.

***Note:** If you are trying to add more cameras than there are channels available you will get a message saying "No available channels to add more cameras". When you see this message all available channels will have a camera added to them but the leftover cameras will not be added to the recorder.*

### 9.1.2.10 Video Menu - Video - IP Channels - Adding Cameras From An Alien DVR

One great feature of the Zip recorders is the ability to add cameras from an Alien DVR as IP cameras. The Alien DVR just needs to be on the same network as your Zip recorder. Before you add your cameras you will need to setup custom protocols as explained in the [Protocol Manage](#) <sup>(145)</sup> section. Once you have setup your custom protocols just follow the steps below.

#### Adding Cameras From An Alien DVR

To add a camera from an Alien DVR go to the **IP Channels** sub-menu. After a few seconds the devices list will be populated, select the Alien DVR from the list and click the **Add** button to display the **Add IP Camera** window. Alternatively you can click the **Add** button and then select the Alien DVR once inside the **Add IP Camera** window.

Add IP Camera ✕

No.	IP Address/Domain	Port	Manufacturer	Device Type	MAC Address	Software
1	192.168.0.240	1240	Alien	MegaHero	28-57-BE-9C-A2-38	V12.3
2	192.168.0.41	8240	ZIP	ZIP108	38-B1-9E-B0-03-2C	V6.21
3	192.168.0.30	8240	ZIP	IPCZIP815W	38-B1-9E-B0-01-1E	V6.21
4	192.168.0.15	8240	ZIP	IPCZIP880B	38-B1-9E-B0-05-5B	V6.21
5	192.168.0.34	8240	ZIP	ZIP216	38-B1-9E-B0-02-3A	V6.21
6	192.168.0.12	8240	ZIP	ZIP204	38-B1-9E-B0-04-5C	V6.21
7	192.168.0.26	8240	ZIP	IPCZIP930W	38-B1-9E-B0-07-2D	V6.21
8	192.168.0.33	8240	ZIP	IPCZIP530W	38-B1-9E-B0-05-1F	V6.21
9	192.168.0.66	8240	ZIP	IPCZIP920W	38-B1-9E-B0-A2-11	V6.21
10	192.168.0.91	8240	ZIP	IPCZIP800B	38-B1-9E-B0-B4-C3	V6.21
11	192.168.0.52	8240	ZIP	IPCZIP530B	38-B1-9E-B0-A2-11	V6.21

IP Address/Domain:

Camera Name:

Port:

Protocol:

Username:

Password:   Show Password

Bind channel:

In the bottom half of the window you will see editable IP settings. It is important to note that this will **not** change any settings on the Alien DVR you are attempting to connect to, these are just the credentials used to connect to the DVR and camera. Therefore these settings have to match those of the target recorder otherwise you will not be able to connect to the camera.

### IP Address/Domain

This is the IP address the recorder will try connect to so this needs to be the IP address of the target Alien DVR.

### Camera Name

You can enter a name up to 8 characters long for your camera. This will be overlaid onto the camera's image during live view and on recorded footage.

### Port

This is the port in the router where the recorder will look for the Alien DVR. This needs to be the RTSP port of the Alien DVR which is **1240** by default.

### Protocol

The protocol needs changing to the one you created in the [Protocol Manage](#)<sup>145</sup> section for the camera you are connecting to.

### Username & Password

These need to be the logon credentials for the admin account of the Alien DVR.

### Bind Channel

The Bind Channel drop-down list allows you to choose which channel the camera is assigned to on the recorder.

Once you are happy with the settings click **Add** to add the camera to the recorder. To exit without adding the camera to the recorder click **Cancel**.

### 9.1.2.11 Video Menu - Video - IP Channels - Managing IP Cameras

You can manage the cameras connected to the IP channels on the recorder in the IP Channels sub-menu. The list at the bottom of the screen shows all of the connected cameras.

The options available will differ for each camera depending on the connection type. This could be a Zip IP camera, a camera connected to another Zip recorder or a camera connected to an Alien DVR.

<input type="checkbox"/>	Camera	Edit	State	IP Address/Domain	Subnet Mask	Port	Manufacturer	Device Type	Protocol	MAC Address	Software Version
<input type="checkbox"/>	IP Cam1			192.168.0.71	255.255.255.0	8240	Zip	IPCZIP880W	Onvif_enhanced	38-B1-9E-B0-17-41	V6.21.5.0_190725
<input type="checkbox"/>	IP Cam2			192.168.0.66	255.255.255.0	8240	Zip	IPCZIP800B	Onvif_enhanced	38-B1-9E-B0-12-1A	V6.21.5.0_190725
	IP Cam3										
	IP Cam4										
	IP Cam5										
	IP Cam6										
	IP Cam7										

Auto Assign IP to Camera(s) Delete Camera Default Password

Total Band Width:32Mbps, Used Band Width:8Mbps

#### Adding Camera

You can add a camera to an available IP channel by clicking the Plus icon. This will open the Add IP Camera window. For more information on adding cameras in this way see the [Adding Single IP Cameras](#)<sup>(131)</sup> section.

#### Deleting Cameras

The easiest way to remove individual cameras is to click the **Delete** button on the camera entry in the device list.

If you want to remove multiple cameras you can simply tick the check box for the cameras you want to remove and click the **Delete Camera** button below the device list.

Delete Camera

#### Edit Connection Information

You can edit the connection settings of a device by clicking the **Edit** icon.

It is important to note that these are **not** the IP settings of the connected device, these are the settings the recorder uses to look for the device. Therefore these settings have to match with the device otherwise the recorder will not be able to connect to it.



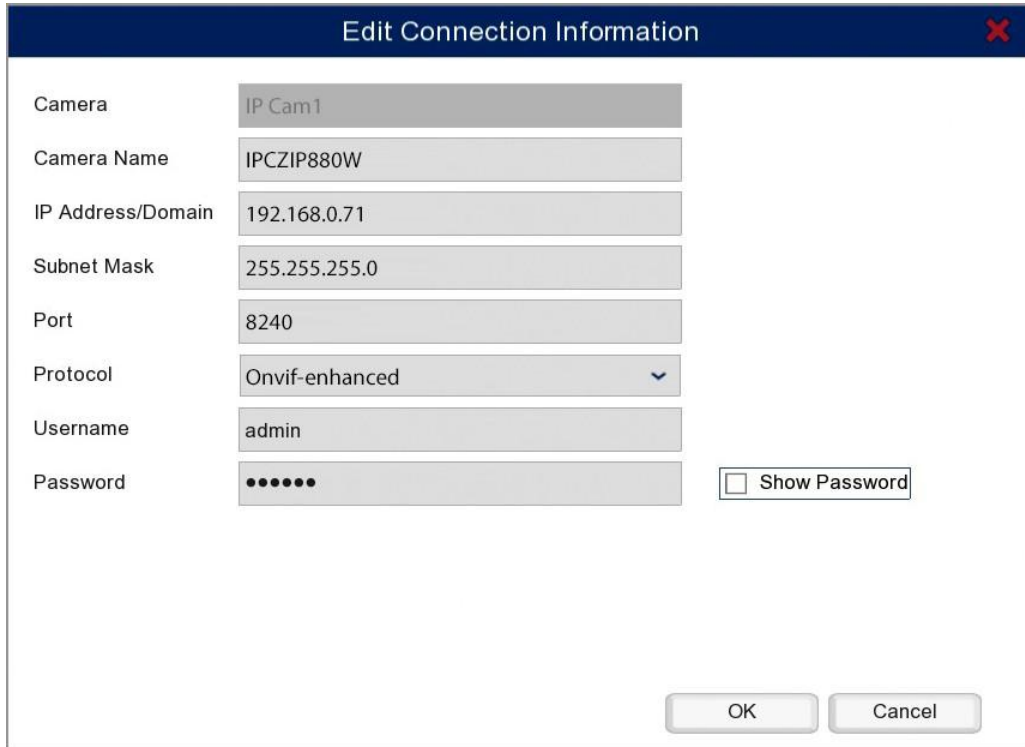

Camera	IP Cam1
Camera Name	IPCZIP880W
IP Address/Domain	192.168.0.71
Subnet Mask	255.255.255.0
Port	8240
Protocol	Onvif-enhanced
Username	admin
Password	•••••

Show Password

OK Cancel

This is handy when the IP settings of a connected device have changed. Rather than having to delete the device and add it again with the new settings, you can simply update the settings here. This will point the recorder in the right direction so that it can re-connect to the device.

You can also quickly switch to a different camera by updating the IP address. If you know the IP settings of a camera you would like to switch to you can enter them in this window. The recorder will then connect to that camera instead.

### IP Camera Status Icon

The **State** column shows the camera's current status. When connected successfully the camera icon will have a small green play icon below it. When connected you can click camera icon to display the camera's image. This is a quick way to check that you are connected to the correct camera.



If the recorder can not connect to the camera, the status icon will show a camera with red play icon below it. This shows that the IP settings you entered for the camera are incorrect, the camera's IP settings have changed since being added to the recorder or that the camera is offline.

When this happens you may need to edit the connection information as explained above if you know the camera's IP settings.

### **Modifying IP Camera Settings**

You can click the Modify IP Camera Settings icon to view and edit the IP settings on the camera itself. For more information see the [IP Camera Settings](#)<sup>127</sup> section.

### **Band Width**

In the bottom right corner of the screen you will see band width figures. These show the **Total Band Width** of the recorder and the **Used Band Width**. The used band width displays the band width currently being used by the connected IP cameras.

### 9.1.3 Video Menu - Video - Protocol Manage

The Protocol Manage screen allows you to setup RTSP (Real Time Streaming Protocol) link to a camera from a 3rd party DVR such as the Alien. This is a useful upgrade tool on larger sites as it lets you view cameras from old legacy systems along with newer Zip devices all in the same place.

#### Creating Custom Protocols

To add cameras from an Alien DVR to your Zip recorder you will need to configure a custom protocol for each camera you plan to add. This is done in the **Protocol Manage** sub-menu inside the **IP Channels** sub-menu.

***Note:** For NVRs with a built-in switch you will need to make sure this is set to manual before adding cameras from the Alien DVR.*

Select the protocol you want to use for the camera from the Custom Protocol drop-down list.

Custom Protocol	Custom Protocol1	
Protocol Name	Alien DVR Ch01	
Stream Type	Mainstream	Substream
Enable Substream	<input checked="" type="checkbox"/>	
Type	RTSP	RTSP
Port	1240	1240
Resources Path	rtsp://192.168.0.240:1240/streaming/channels/101	rtsp://192.168.0.240:1240/streaming/channels/102

#### Protocol Name

You can change the **Protocol Name** to something more meaningful, for example "Alien DVR CH01". This will make things much easier when adding the cameras later. Your protocol names can be up to 15 characters long.

#### Enable Substream

By default the Substream check box will be ticked. With Substream enabled the Mainstream and lower quality Substream feeds will both be recorded.

This can come in handy when watching footage back over the internet using the mobile app or PC software. If you have a slow internet connection you can switch to the less demanding, lower quality substream.

#### Type

RTSP will be selected by default as this is the only stream type currently supported.

### Port

This needs to be the RTSP port of the DVR. For Alien DVRs this is 1240 by default.

### Resource Path

This is the RTSP string used for connecting to the camera on the target Alien DVR and is made up as followed:

```
rtsp://[IP Address of target DVR]:[RTSP port of target DVR]/streaming/channels/[Channel number on target DVR]/[01 for Mainstream or 02 for Substream]
```

Here is an example if you were looking to setup the mainstream for channel 1 on an Alien DVR which has the IP address 192.168.1.240.

```
rtsp://192.168.1.240:1240/streaming/channels/101
```

### Saving Protocols

Once you have finished click Apply. Repeat these steps creating a new custom protocol for each camera you want to add from the Alien DVR.

To add you new camera links to you Zip recorder see the [Adding Cameras From An Alien DVR](#)<sup>(140)</sup> section.

## 9.2 Video Menu - Live

The Live sub-menu in the Video menu allows you to dictate how a camera's details and image are visually displayed during live view and on recorded files.

Settings available will differ depending on recorder, camera type and camera model.

Camera	Setup	Covert	Channel Name	Show Name	Date Format	Time Format	Show Time	Refresh Rate	Camera type
Cam1		<input type="checkbox"/>	CH1	<input checked="" type="checkbox"/>			<input checked="" type="checkbox"/>		AUTO
Cam2		<input type="checkbox"/>	CH2	<input checked="" type="checkbox"/>			<input checked="" type="checkbox"/>		AUTO
Cam3		<input type="checkbox"/>	CH3	<input checked="" type="checkbox"/>			<input checked="" type="checkbox"/>		AUTO
Cam4		<input type="checkbox"/>	CH4	<input checked="" type="checkbox"/>			<input checked="" type="checkbox"/>		AUTO
Cam5		<input type="checkbox"/>	CH5	<input checked="" type="checkbox"/>			<input checked="" type="checkbox"/>		AUTO
Cam6		<input type="checkbox"/>	CH6	<input checked="" type="checkbox"/>			<input checked="" type="checkbox"/>		AUTO
Cam7		<input type="checkbox"/>	CH7	<input checked="" type="checkbox"/>			<input checked="" type="checkbox"/>		AUTO
Cam8		<input type="checkbox"/>	CH8	<input checked="" type="checkbox"/>			<input checked="" type="checkbox"/>		AUTO
Cam9		<input type="checkbox"/>	CH9	<input checked="" type="checkbox"/>			<input checked="" type="checkbox"/>		AUTO
Cam10		<input type="checkbox"/>	CH10	<input checked="" type="checkbox"/>			<input checked="" type="checkbox"/>		AUTO
Cam11		<input type="checkbox"/>	CH11	<input checked="" type="checkbox"/>			<input checked="" type="checkbox"/>		AUTO
Cam12		<input type="checkbox"/>	CH12	<input checked="" type="checkbox"/>			<input checked="" type="checkbox"/>		AUTO
Cam13		<input type="checkbox"/>	CH13	<input checked="" type="checkbox"/>			<input checked="" type="checkbox"/>		AUTO
Cam14		<input type="checkbox"/>	CH14	<input checked="" type="checkbox"/>			<input checked="" type="checkbox"/>		AUTO
Cam15		<input type="checkbox"/>	CH15	<input checked="" type="checkbox"/>			<input checked="" type="checkbox"/>		AUTO
Cam16		<input type="checkbox"/>	CH16	<input checked="" type="checkbox"/>			<input checked="" type="checkbox"/>		AUTO
W Cam1		<input type="checkbox"/>			MM/DD/YYYY	24 Hour			
IP Cam1		<input type="checkbox"/>	Camera	<input checked="" type="checkbox"/>	DD/MM/YYYY	24 Hour	<input checked="" type="checkbox"/>	50Hz	

### Camera

Lists all channels on the recorder.

### Setup

Clicking the cog icon takes you to the [Setup](#)<sup>149</sup> screen for that camera. The Setup screen displays the camera's image as well as the same setting options from this screen plus images controls for Hue, Brightness, Contrast and Saturation. Having the camera's live images displayed allows you to see changes in real-time.

### Covert

The Covert tick-box is an easy way to set a channel up for covert recording. When the Covert tick-box is checked the camera's footage is still recorded but it will not appear in live view displays.

### Channel Name

You can give each channel a more relevant name such as "Gate" rather than the default CH1, IP CAM1 etc. Clicking inside the Channel Name field will display the [virtual keyboard](#)<sup>31</sup> so you can enter a new channel name of up to 40 characters.

### Show Name

When this tick-box is selected the channel name will be overlaid on the camera's image during live view and an on recorded footage. To hide the channel name just untick this option.

### Date Format

You can change how the date is displayed in Date Format drop down list. There are 3 options to choose from, MM/DD/YYYY, YYYY-MM-DD or DD/MM/YYYY.

### Time Format

You can choose if the time is displayed on the cameras image in 12 or 24 hour format using the Time Format drop down list.

### Show Time

When this tick-box is selected the time will be overlaid on the camera's image during live view and an on recorded footage. To hide the time just untick this option.

### Refresh Rate

You can set the camera's refresh rate as 50Hz or 60Hz using the drop down list.

### Camera Type

For HD cameras you can choose the Camera Type for each camera from the drop down list. By default the camera type will be set to Auto which will automatically detect the camera type and configure the recorder accordingly. When set to auto TVI, CVI, AHD and CVBS cameras are supported on that channel. You also have the option to specify TVI or AHD cameras only from the drop down list.

### Copy Settings

You can copy settings from one camera to another as explained in [Parameter Copy](#)<sup>(319)</sup> section. Just click the **Copy** button the display the **Parameter Copy** window.

### Defaulting Settings

You can restore settings back to their default value by clicking the **Default** button.

### Saving Changes

Once you have configured your cameras click **Apply** to save your new settings.

## 9.2.1 Video Menu - Live - Setup

The Setup screen from the Live sub-menu shows live camera images and allows you to dictate how a camera's details and image are visually displayed during live view and on recorded files.

Having the camera's live images displayed is a great advantage as it allows you to see changes in real-time.

Settings available will differ depending on recorder, camera type and camera model.



### Camera

The Setup screen will display the camera selected in the Live sub-menu. You can configure a different camera by selecting it from the drop down list.

### Channel Name

You can give each channel a more relevant name such as "Gate" rather than the default CH1, IP CAM1 etc. Clicking inside the Channel Name field will display the [virtual keyboard](#)<sup>(31)</sup> so you can enter a new channel name of up to 40 characters.

### Date Format

You can change how the date is displayed in Date Format drop down list. There are 3 options to choose from, MM/DD/YYYY, YYYY-MM-DD or DD/MM/YYYY.

### Time Format

You can choose if the time is displayed on the cameras image in 12 or 24 hour format using the Time Format drop down list.

### Covert

The Covert tick-box is an easy way to set a channel up for covert recording. When the Covert tick-box is checked the camera's footage is still recorded but it will not appear in live view displays.

### Show Name

When this tick-box is selected the channel name will be overlaid on the camera's image during live view and an on recorded footage. To hide the channel name just untick this option.

### Show Time

When this tick-box is selected the time will be overlaid on the camera's image during live view and an on recorded footage. To hide the time just untick this option.

### Picture Settings

You can also adjust the camera's image in the in the Setup screen to get the best picture possible. You will see sliders for the Hue, Brightness, Contrast and Saturation. Each slider can be set from 0 to 255 and you will see the effect your adjustments have in real-time on the live images. When you are happy with your settings click the **Apply** button to save them. To return the picture settings back to their default values just click the **Default** button.

### Saving Changes

Once you have configured your camera click **Apply** to save a refresh the live images in the right hand side with your new settings.



### 9.3 Video Menu - Image Control

In the Image Control sub-menu you can view and configure the image settings of the compatible IP cameras connected to the recorder.

Camera	Setup	IR-CUT Mode	IR-CUT Delay	Lens Flip	Angle Flip	Roate	BLC Level	3D Noise Reduction	DWDR	AGC	White Balance	Time Exposure	Defog Level
IP Cam1		GPIO Auto	2	OFF	OFF	0	OFF	Auto	128	Low	Auto	Auto	Disable
IP Cam2		Colour Mode	2	OFF	OFF	0	OFF	Auto	214	Middle	Auto	Auto	Disable

The main screen will show the current settings for each connected IP camera. To make changes to a camera click the cog icon to enter the **Setup** screen.

Settings available will differ depending on the camera model.



#### Camera

The Setup screen will display the camera selected in the Image Control sub-menu. You can configure a different camera by selecting it from the drop down list.

#### IR-Cut Mode

You can control the camera's day/night settings using the IR-Cut Mode drop down list. **GPIO Auto** will switch between colour and black and white IR modes depending on the available light. **Colour Mode** will force the camera to stay in colour for environment with a constant source. **Black White Mode** will force the camera to stay in black and white which is ideal for constant low light areas.

### IR-Cut Delay

The IR-Cut Delay slider lets you adjust the amount of time the camera waits before switching to black and white when light levels drop below the minimum usable level.

The idea of a delay is to take into account things like passing clouds which may briefly cause light levels to drop. If light levels return to a usable level within the IR-Cut Delay time the camera will stay in Colour mode. This prevents the camera repeatedly switching from colour to black and white unnecessarily.

The slider can be set between 1 and 36 seconds.

### IR-LED

There are 3 options to choose from for controlling the camera's night vision IR LEDs. **Auto** will turn the the IR LEDs on and off as and when they are required. **On** will force the IR LEDs to be switched on constantly. This is a handy in dark environments but will have adverse effects in bright environments as the cameras sensor will be over saturated with IR light. **Off** will make sure the camera's IR LEDs never switch on. This is useful in areas which have a constant light source to prevent over saturation.

### Lens Flip

This option will flip the cameras image vertically.

### Angle Flip

This option will flip the camera's image horizontally.

### Rotate

The Rotate drop down list gives you options for rotating the camera's image.

### Back Light (BLC)

When enabled Back Light adjusts the exposure of the entire image to properly expose a subject in the foreground when a bright light source, such as a window, is situated behind it.

### BLC Level

The BLC Level slider allows you to specify the strength of the Back Light compensation. You can set the slider between 1 and 15 with 1 being the weakest and 15 being the strongest.

### BLC Area

In the BLC Area drop down list you can set which area of the camera's image the back light compensation is applied to. You can set the area to Top, Left, Down, Right or Centre.

### 3D Noise Reduction

This applies a digital filter to reduce noise in the foreground and the background of the camera's image. You can choose **Disable** to turn off the filter, **Auto** to allow the camera to decide for itself the strength of the filter required or **Manual**. Choosing Manual will display a **Level** slider for you to set the strength of the filter applied between 1 and 255.

### DWDR (Digital Wide Dynamic Range)

This option digitally adjusts the exposure in different parts of the image to maintain optimum light levels in both the dark and bright areas of the camera's image. When enabled you will see a **Level** slider for you to set the strength of the filter applied between 1 and 255.

### HLC (Highlight Compensation)

Masks areas of intense light to properly expose other areas of the image. For example a car's headlights would be masked reducing glare making the number plate visible.

When HLC is enabled the camera will automatically mask bright areas of the camera's image. Additionally you can set the level of compensation between 1 and 255 using the Level slider.

### AGC (Automatic Gain Control)

The AGC slider automatically adjusts the video amplitude to maintain a bright image. You can choose the level of amplitude however setting it to high could produce a noisy image in low light environments. You can set the AGC level between 1 and 128.

### White Balance

White Balance is configured so that objects appear a natural colour. There are 3 options to choose from. **Auto**, **Indoor** and **Manual**. When set to Manual you will get 3 sliders for setting the Red, Green and Blue values individually between 1 and 255.

### BLC Area

In the BLC Area drop down list you can set which area of the camera's image the back light compensation is applied to. You can set the area to Top, Left, Down, Right or Centre.

### Shutter

The shutter mode controls the camera's iris. When set to **Auto** the iris will adjust to changing light levels by opening and closing automatically to take in the optimum amount of light. When set to **Manual** the iris will be fixed at its current position then the Exposure Time can be used to set the shutter speed.

### Exposure Time

The exposure time is the shutter speed of the camera which controls how long the image sensor is exposed to light. It is measured in fractions of a second with 1/5 of a second being the slowest time and 1/20000 of a second being the fastest time.

When the Shutter Mode is set to **Auto** the Exposure Time won't have too much of an effect as the iris will adjust to compensate for it.

When the Shutter Mode is set to **Manual** the Exposure Time will have a massive effect on the brightness of the image. The lower the Exposure Time the slower the shutter speed therefore more light is captured by the image sensor. However with a slow shutter speed moving objects may look blurred as they have moved across the image while they are being captured. The higher the Exposure Time the faster the shutter speed reducing motion blur however less light is captured by the image sensor resulting in a darker image.

### Defog Mode

The Defog Function is used to improve image clarity in foggy and misty conditions. The feature is usually disabled by default.

When set to **Auto** the camera will automatically adjust to improve image clarity. Auto, however, may have negative effects when used in clear weather conditions as the camera will still apply the filter to the image.

**Manual** mode will display a slider for setting the Defog Level. You can set the strength between 1 and 255. However, as with Auto mode this may have negative effects when used in clear weather conditions as the camera will still apply the filter to the image.

### Defaulting Settings

To return the Image Control settings back to their default values just click the Default button.

### Exiting

Once you have configured your camera right click the mouse to return to the Image Control sub-menu.

## 9.4 Video Menu - PTZ

In the PTZ sub-menu you can configure the communication settings for the PTZ and UTC (Up The Co-ax) cameras connected to your recorder.

Camera	Signal Type	Protocol	Baudrate	DataBit	StopBit	Parity	Address
Cam1	Analogue	COAX1	2400	8	1	None	1
Cam2	Analogue	COAX1	2400	8	1	None	2
Cam3	Analogue	COAX1	2400	8	1	None	3
Cam4	Analogue	COAX1	2400	8	1	None	4
IP Cam1	Network	Pelco-D	2400	8	1	None	5
IP Cam2	Network	Pelco-D	2400	8	1	None	6

The main screen will display a list of all channels on the recorder and their current communication settings.

Settings available will differ depending on the recorder and camera model.

### Camera

Lists all channels on the recorder.

### Signal Type

The drop down lists allow you to specify the connection method of IP cameras so the recorder knows whether to send the control signals via the **Network** or via the **RS485** port.

Analogue cameras will always show as "Analogue" as the recorder determines how to send the control signal based on the Protocol.

### Protocol

You can choose the protocol for each camera from a drop down list. the protocol is the communication language so this needs to be one the camera supports.

Analogue cameras can be set as **COAX1** or **COAX2** for control of UTC compatible cameras. For PTZs or other cameras connected via RS485 you can choose **Pelco-D** or **Pelco-P**.

For IP cameras this option is disabled when Network is selected as the Signal type. When the Signal Type is set as RS485 you can choose **Pelco-D** or **Pelco-P**.

### Baudrate

You can select the baudrate from the drop down list with 4 options available, **1200**, **2400**, **4800** or **9600**. Different cameras work on different baudrates so the baudrate set here needs to be one that the camera supports.

You only need to worry about the baudrate when the camera's Protocol is set to Pelco-D or Pelco-P. For all other cameras you can leave these settings as they are.

### DataBit

This needs to match the databit set in the camera. By default this will be 8 and should only need changing if it has been changed in the camera. You can change the databit if required from the drop down list.

You only need to worry about the databit when the camera's Protocol is set to Pelco-D or Pelco-P. For all other cameras you can leave these settings as they are.

### StopBit

This needs to match the stopbit set in the camera. By default this will be 1 and should only need changing if it has been changed in the camera. You can change the stopbit if required from the drop down list.

You only need to worry about the stopbit when the camera's Protocol is set to Pelco-D or Pelco-P. For all other cameras you can leave these settings as they are.

### Parity

This needs to match the parity set in the camera. By default this will be set to None and should only need changing if it has been changed in the camera. You can change the parity if required from the drop down list.

You only need to worry about the parity when the camera's Protocol is set to Pelco-D or Pelco-P. For all other cameras you can leave these settings as they are.

### Address

Each camera must have their own unique address so that you can specify which camera to target when sending commands. You can edit a cameras address by clicking in the address field to display the [virtual keyboard](#)<sup>(31)</sup>.

### Copy Settings

You can copy settings from one camera to another as explained in [Parameter Copy](#)<sup>(319)</sup> section. Just click the **Copy** button the display the **Parameter Copy** window.

### Defaulting Settings

To return the PTZ settings back to their default values just click the **De fault** button.

### Saving Changes

Once you have configured your cameras click **Apply** to save your new settings.

## 9.5 Video Menu - Video Cover

You can create up to 4 privacy masking zones for each channel in the Video Cover sub-menu. This is an easy way to comply with GDPR and data protection as you can mask off sensitive areas of the camera's image.

Settings available will differ depending on the recorder and camera model. For IP cameras privacy masking may need to be set up in the camera itself.

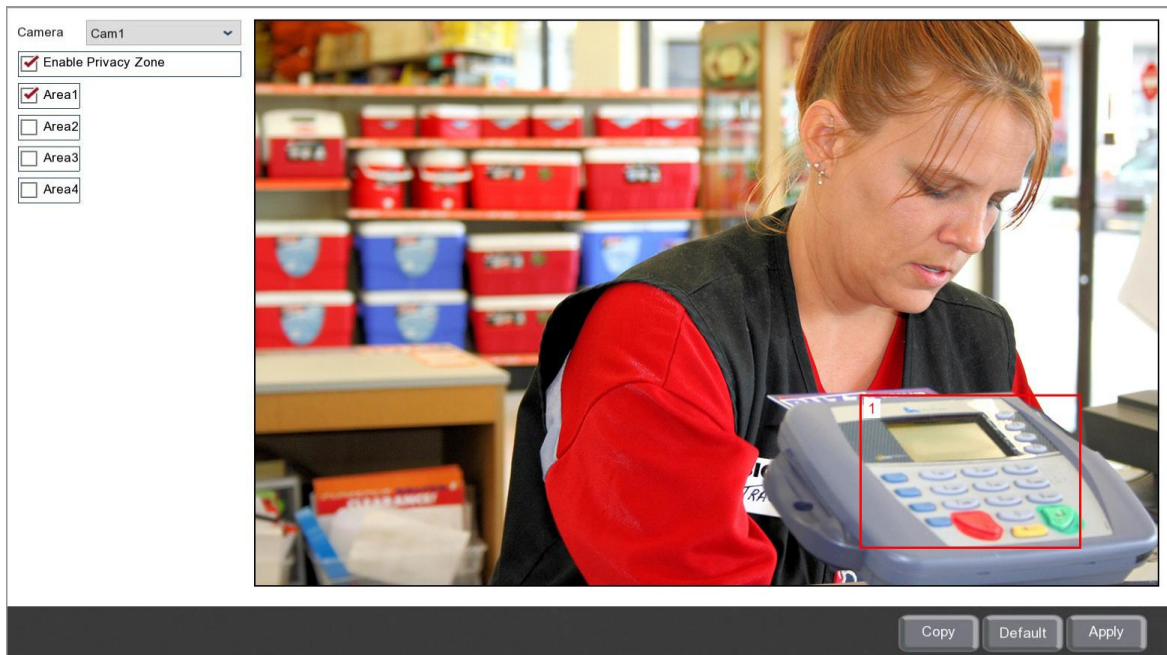

### Creating Privacy Zones

It's easy to create and edit privacy zones just follow the steps below.

1. Select the camera you want to add privacy zones to from the Camera drop down list.
2. Tick the "Enable Privacy Zone" check box.
3. Tick the check box of the area you want to create from Area1 to Area4. A red rectangle will appear on screen showing which area of the camera's image will be masked. The area's number is shown in the top right hand corner of each privacy zone.
4. When you are happy with your privacy areas click the **Apply** button.

### Modifying Privacy Zones

1. To resize an area just click and hold the bottom right corner of the red outline and drag it where required.
2. To move an area just click and hold inside the red outline and drag it where required.
3. When you are happy with your privacy areas click the **Apply** button.



### Removing Privacy Zones

1. To remove an area simply untick the check box for that area then click the **Apply** button.
2. To remove all areas just from the selected camera just click the **Default** button.

### Copying Privacy Zones

You can copy privacy zones from one camera to another by clicking the **Copy** button as explained in the [Parameter Copy](#)<sup>(319)</sup> section.

### Defaulting Settings

To return the settings back to their default values just click the **Default** button.

### Saving Changes

Once you have configured your cameras click **Apply** to save your new settings.



## 9.6 Video Menu - Motion

You can setup motion detection for each camera on the recorder in the Motion sub-menu. Setting up motion detection allows you to record footage or trigger an alarm when movement is detected. These are also the same options you will see if you click the **Motion** button when setting up motion alarms.

The settings available will differ depending on recorder, camera type and camera model.

Camera	Setup	Switch	Sensitivity
Cam1		<input type="checkbox"/>	4
Cam2		<input type="checkbox"/>	4
Cam3		<input type="checkbox"/>	4
Cam4		<input type="checkbox"/>	4
Cam5		<input type="checkbox"/>	4
Cam6		<input type="checkbox"/>	4
Cam7		<input type="checkbox"/>	4
Cam8		<input type="checkbox"/>	4
Cam9		<input type="checkbox"/>	4
Cam10		<input type="checkbox"/>	4
Cam11		<input type="checkbox"/>	4
Cam12		<input type="checkbox"/>	4
Cam13		<input type="checkbox"/>	4
Cam14		<input type="checkbox"/>	4
Cam15		<input type="checkbox"/>	4
Cam16		<input type="checkbox"/>	4
W Cam1			8

Alarm Copy Default Apply

### Camera

Lists all channels on the recorder.

### Setup

Clicking the cog icon takes you to the [Setup](#)<sup>160</sup> screen for that camera. The Setup screen displays the camera's image as well as the motion detection grid where you can select the detection area.

### Switch

Ticking and unticking the **Switch** check box will enable and disable motion detection for that camera.

### Sensitivity

You can set the sensitivity level for the motion detection from 1 to 8 in the drop down list.

1 is the lowest sensitivity level and will only trigger when there is a large amount of movement inside the defined detection area.

8 is the highest sensitivity level and will trigger when slight movement is detected inside the defined detection area.

### Alarm Handling

Clicking the **Alarm** button will open the Alarm Handling screen where you can set what actions the recorder will take when motion is detected for each channel. For more information on setting up alarm handling see the [Alarm Menu - Motion](#)<sup>(220)</sup> section.

### Copying Motion Detection Settings

You can copy motion detection settings from one camera to another by clicking the **Copy** button as explained in the [Parameter Copy](#)<sup>(319)</sup> section.

### Defaulting Motion Detection Settings

You can reset all motion detection settings for each camera by clicking the **Default** button. This will restore factory settings.

### Saving Changes

Once you are happy with your settings click the **Apply** button to save them. Alternatively you can right click with the mouse to exit the Motion menu without saving changes.

## 9.6.1 Video Menu - Motion - Setup

When you click a camera's **Setup** icon in the [Motion Detection](#)<sup>(159)</sup> sub-menu the Motion Setup screen will be displayed.

As well as allowing you to configure the camera's motion settings, the Motion Setup screen allows you to draw grids to specify the areas of the camera's image you want to observe for motion.

The recorder will then only look for motion within the gridded areas and ignore any motion outside of these. This enables you to specify a doorway or an area around parked vehicles for example.

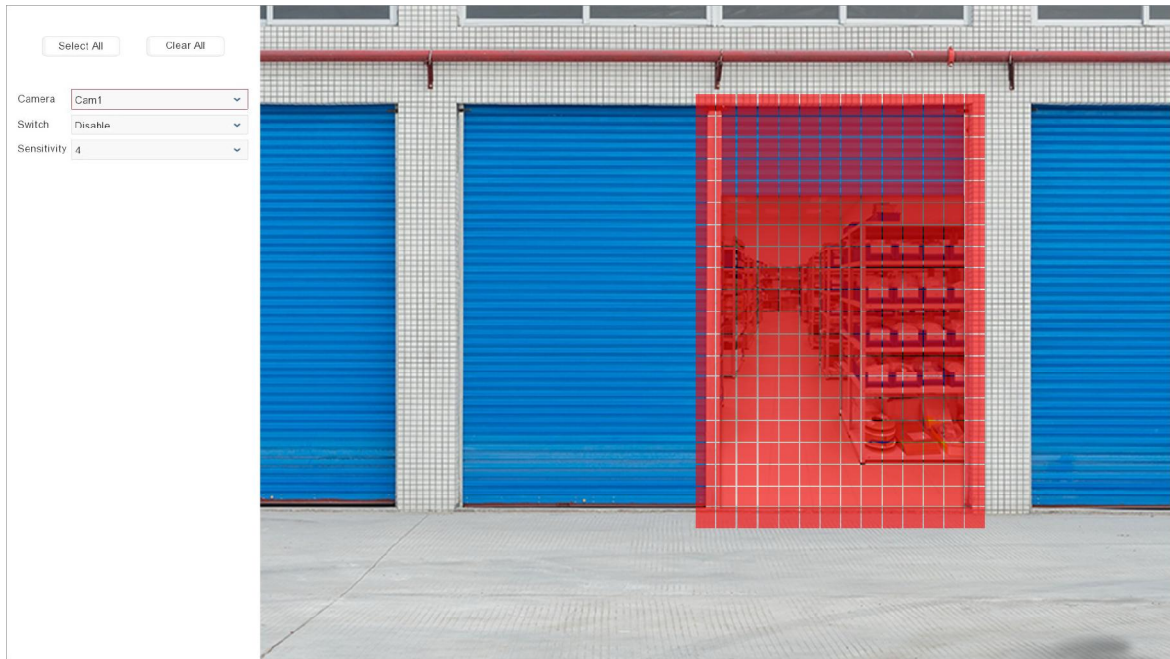

### Setting And Removing Motion Areas

You can create or remove a motion area by left clicking the mouse and dragging over the area you want to select or deselect. You can create multiple motion areas within the camera's image in this way.

### Observing The Entire Camera Image

You can click the **Select All** button to draw a grid over the entire screen to watch for any motion within the camera's image.

### Removing All Motion Areas

To remove all motion grids on the camera's image in one go just click the **Clear All** button.

### Camera

You can select which camera's motion settings you want to configure by selecting it from the **Camera** drop down list.

### Switch

The **Switch** allows you to enable or disable motion detection for the selected camera.

### Sensitivity

You can set the sensitivity level for the motion detection from 1 to 8 in the drop down list.

1 is the lowest sensitivity level and will only trigger when there is a large amount of movement inside the defined detection area.

8 is the highest sensitivity level and will trigger when slight movement is detected inside the defined detection area.

### **Saving Changes**

Once you have configured the motion settings as required click the right mouse button to exit the setup screen and return to the Motion sub-menu.

## 9.7 Video Menu - Smart

The Smart menu is designed for use with Zip AI cameras which have a range of highly advanced detection features to enhance your CCTV system and monitoring capabilities.

The Smart features available depend on the model of recorder and cameras being used.

The Smart menu allows you to configure these extra features for all the Zip AI IP cameras connected to the recorder.

- [PID](#)<sup>(163)</sup> (Perimeter Intrusion Detection)
- [LCD](#)<sup>(167)</sup> (Line Crossing Detection)
- [SOD](#)<sup>(171)</sup> (Stationary Object Detection)
- [PD](#)<sup>(175)</sup> (Pedestrian Detection)
- [FD](#)<sup>(180)</sup> (Face Detection)
- [CC](#)<sup>(186)</sup> (Cross Counting)
- [Sound Detection](#)<sup>(190)</sup>
- [Lens Covered](#)<sup>(193)</sup>
- [Schedule](#)<sup>(195)</sup>
- [Intelligent Analysis](#)<sup>(197)</sup>

### 9.7.1 Video Menu - Smart - PID

The PID (Perimeter Intrusion Detection) feature allows you to define an area of the camera's image and then trigger an event when something moves into or out of that area.

**Note:** You can not enable Cross Counting when PID, LCD or SOD are enabled and vice versa.

Camera	Setup	Switch	Sensitivity	Scene
IP Cam1		<input type="checkbox"/>	3	Indoor
IP Cam2		<input type="checkbox"/>	3	Indoor
IP Cam3		<input type="checkbox"/>	3	Indoor
IP Cam4		<input type="checkbox"/>	3	Indoor

Alarm Apply

## Camera

Lists all compatible AI cameras on the recorder.

## Perimeter Configuration

You can define up to 4 perimeters as shown in the [PID Setup](#)<sup>(164)</sup> section by clicking the **Cog** icon. You will need to define at least one area so that the recorder knows where to monitor.

## Enabling PID

To enable or disable PID for each camera just tick or untick the **Switch** check box.

Please note that PID will only be enabled whenever smart detection features are active as specified in the [Smart Schedule](#)<sup>(195)</sup>.

## Sensitivity

By setting the **Sensitivity** you can avoid false triggers or capture slight movements.

**1** is the lowest sensitivity level and will only trigger when there is a large amount of movement where something clearly crosses into or out of the perimeter area. Setting a low sensitivity level can prevent false triggers for something like a tree or bush moving in the wind.

**4** is the highest sensitivity level and will trigger with the slightest movement over the perimeter. High sensitivity levels are more suited to internal cameras away from environmental conditions.

## Scene

You should set the **Scene** to match where the camera has been installed. Setting the Scene correctly allows the recorder to make allowances for typical light levels and produce more accurate results. You can choose between **Indoor** or **Outdoor** from the **Scene** drop down list to best suit the camera's installation.

## Alarm Handling

Clicking the **Alarm** button will open the Alarm Handling screen where you can set what actions the recorder will take when a perimeter is crossed. For more information on setting up alarm handling see the [Alarm Menu - Smart](#)<sup>(226)</sup> section.

## Saving Changes

When you are happy with the current settings click the **Apply** button to save your changes. If you exit the window without saving any changes will be lost.

### 9.7.1.1 Video Menu - Smart - PID Setup

When you click a camera's **Setup** icon in the [PID](#)<sup>(163)</sup> sub-menu the PID Setup screen will be displayed.

In the PID setup screen you can create up to 4 perimeters which allows you to monitor movement in and out of these zones.



### Selecting Your Camera

You can select the camera you want to configure perimeters for from **Camera** drop down list.

### Selecting A Perimeter

You can create and configure up to 4 perimeters for each camera. These perimeter configurations are called **Rules**. You can select which Rule you want to create or edit by selecting it from the **Rule Number** drop down list.

To make things easier you can quickly tell which perimeter belongs to which Rule as it has a red Rule Number in the top left corner of the defined area.

### Creating A Perimeter

To create a perimeter just follow these easy steps:

1. Select the Rule Number you want to create the perimeter for from the Rule Number drop down list.
2. Click on the camera's image where you want to set the top left corner of the perimeter.
3. Click where you want to set the bottom left corner.
4. Click where you want to set the bottom right corner.
5. Finally click where you want to set the top right corner of the perimeter.

You will notice as you are setting your corner points the recorder will draw a yellow box between the points.

## Editing A Perimeter

You can edit an existing perimeter as followed:

1. Select the Rule Number you want to edit the perimeter for from the Rule Number drop down list.
2. Click the red square in the top left corner of the parameter.
3. Click and drag the 4 corners to reposition them.
4. Click the red square in the top left corner to confirm and set the new positions.

## Enabling And Disabling Individual Perimeters

You can turn each of the camera's 4 Rules **On** or **Off** independently as and when they are needed as described below:

1. Select the Rule Number you want to turn On/Off from the Rule Number drop down list.
2. Using the **Rule Switch** check box you can then turn the rule **On** (ticked) or **Off** (unticked).

## Trigger On Entering A Perimeter, Exiting A Perimeter Or Both

There are 3 options as to what direction of movement will trigger PID. We call these options **Rule Types**.

For simplicity we label the area inside a perimeter **A** and the area outside the perimeter **B**. The direction of movement is also indicated by the light blue arrows on each side of the perimeter. To choose a Rule Type first select the Rule Number you want configure then select a Rule Type as described below from the **Rule Type** drop down list.

- **A->B** - This option will only trigger when an object moves from inside the perimeter (A) to outside the perimeter (B).
- **B->A** - This option will only trigger when an object moves from outside the perimeter (B) to inside the perimeter (A).
- **A<->B** - This option will trigger when an object crosses the perimeter in either direction.

## Deleting Perimeters

You have 2 options when removing perimeters from a camera; you can remove individual perimeters or all perimeters as explained below:

### Remove Individual Perimeters

To remove a perimeter click the **Red Square** in the top left corner of the perimeter to select it and then click the **Remove** button to delete it.

### Remove All Perimeters

To remove all perimeters from the chosen camera simply click the **Remove All** button.

## Saving Changes





When you are happy with the current settings click the **Save** button. If you exit the window without saving any changes will be lost.



## 9.7.2 Video Menu - Smart - LCD

The LCD (Line Crossing Detection) feature allows you to draw a line on the camera's image and then trigger an event if anything crosses over it.

**Note:** You can not enable Cross Counting when PID, LCD or SOD are enabled and vice versa.

Camera	Setup	Switch	Sensitivity	Scene
IP Cam1		<input type="checkbox"/>	3	Indoor
IP Cam2		<input type="checkbox"/>	3	Indoor
IP Cam3		<input type="checkbox"/>	3	Indoor
IP Cam4		<input type="checkbox"/>	3	Indoor

Alarm Apply

### Camera

Lists all compatible AI cameras on the recorder.

### Line Crossing Configuration

You can draw up to 4 lines per camera as shown in the [LCD Setup](#)<sup>168</sup> section by clicking the **Cog** icon. You will need to define at least one line so that the recorder knows where to monitor.

### Enabling LCD

To enable or disable LCD for each camera just tick or untick the **Switch** check box.

Please note that LCD will only be enabled whenever smart detection features are active as specified in the [Smart Schedule](#)<sup>195</sup>.

### Sensitivity

By setting the **Sensitivity** you can avoid false triggers or capture slight movements.

1 is the lowest sensitivity level and will only trigger when there is a large amount of movement where something clearly crosses over the line. Setting a low sensitivity level can prevent false triggers for something like a tree or bush moving in the wind.

4 is the highest sensitivity level and will trigger with the slightest movement over the line. High sensitivity levels are more suited to internal cameras away from environmental conditions.

### Scene

You should set the **Scene** to match where the camera has been installed. Setting the Scene correctly allows the recorder to make allowances for typical light levels and produce more accurate results. You can choose between **Indoor** or **Outdoor** from the **Scene** drop down list to best suit the camera's installation.

### Alarm Handling

Clicking the **Alarm** button will open the Alarm Handling screen where you can set what actions the recorder will take when a line is crossed. For more information on setting up alarm handling see the [Alarm Menu - Smart](#) <sup>(226)</sup> section.

### Saving Changes

When you are happy with the current settings click the **Apply** button to save your changes. If you exit the window without saving any changes will be lost.

#### 9.7.2.1 Video Menu - Smart - LCD Setup

When you click a camera's **Setup** icon in the [LCD](#) <sup>(167)</sup> sub-menu the LCD Setup screen will be displayed.

In the LCD setup screen you can create up to 4 line crossings which allows you to monitor movement across these imaginary barriers.

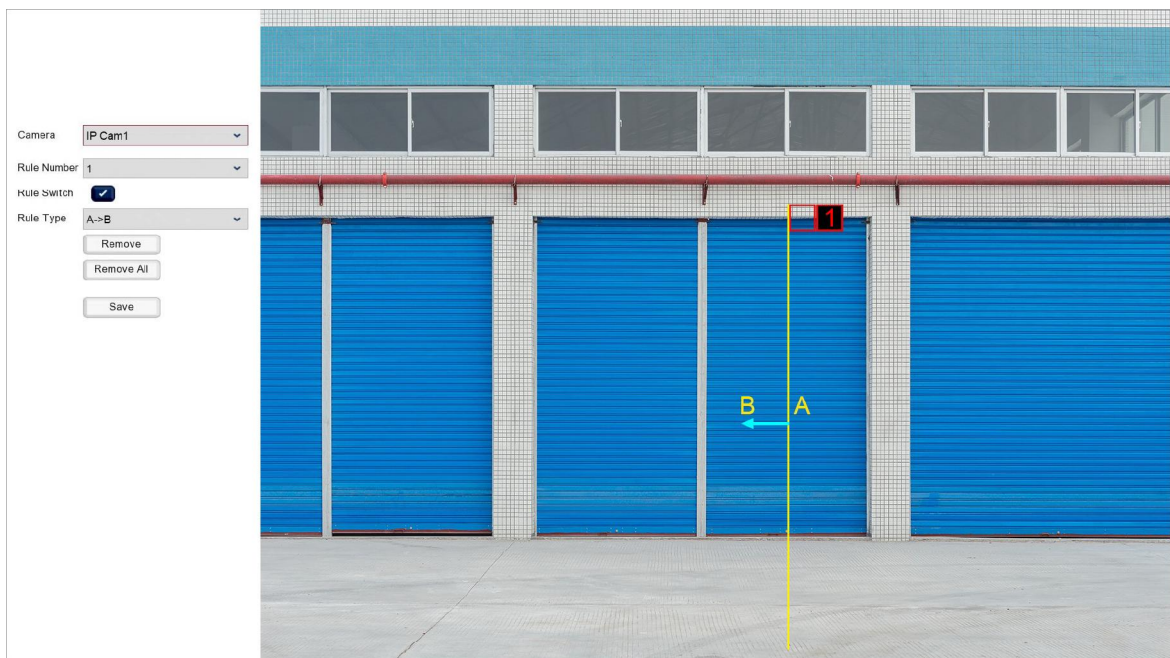

## Selecting Your Camera

You can select the camera you want to configure line crossings for from **Camera** drop down list.

## Selecting A Line Crossing

You can create and configure up to 4 line crossings for each camera. These line crossing configurations are called **Rules**. You can select which Rule you want to create or edit by selecting it from the **Rule Number** drop down list.

To make things easier you can quickly tell which line crossing belongs to which Rule as it has a red Rule Number at the start of the line.

## Creating A Line Crossing

To create a line crossing just follow these easy steps:

1. Select the Rule Number you want to create the line crossing for from the Rule Number drop down list.
2. Click on the camera's image where you want to start the line crossing.
3. Click where you want to stop the line crossing.

You will notice as you are setting your points the recorder will draw a yellow line between them.

## Editing A Line Crossing

You can edit an existing line crossing as followed:

1. Select the Rule Number you want to edit the line crossing for from the Rule Number drop down list.
2. Click the red square at the start of the line.
3. Click and drag the the start and end points to reposition them.
4. Click the red square at the start of the line to confirm and set the new positions.

## Enabling And Disabling Individual Line Crossings

You can turn each of the camera's 4 Rules **On** or **Off** independently as and when they are needed as described below:

1. Select the Rule Number you want to turn On/Off from the Rule Number drop down list.
2. Using the **Rule Switch** check box you can then turn the rule **On** (ticked) or **Off** (unticked).

## Trigger On When The Line Is Crossed From 1 Direction Or Both

There are 3 options as to what direction of movement will trigger LCD. We call these options **Rule Types**.

For simplicity we label the area on one side of the line **A** and the area on the other side of the line **B**. The direction of movement is also indicated by the light blue arrow in the middle of the line. To choose a Rule Type first select the Rule Number you want configure then select a Rule Type as described below from the **Rule Type** drop down list.

- **A->B** - This option will only trigger when an object moves across the line from side A to side B.
- **B->A** - This option will only trigger when an object moves across the line from side B to side A.
- **A<->B** - This option will trigger when an object crosses the line in either direction.

### Deleting Line Crossings

You have 2 options when removing line crossings from a camera; you can remove individual line crossings or all line crossings as explained below:

#### Remove Line Crossings

To remove a line crossing click the **Red Square** at the start of the line to select it and then click the **Remove** button to delete it.

#### Remove All Line Crossings

To remove all line crossings from the chosen camera simply click the **Remove All** button.

### Saving Changes

When you are happy with the current settings click the **Save** button. If you exit the window without saving any changes will be lost.

### 9.7.3 Video Menu - Smart - SOD

The SOD (Stationary Object Detection) feature allows you to draw a box on the camera's image and then trigger an event if anything changes inside it. This can be if an object enters the box and remains within it or if an object which was originally inside the box is removed.

This clever feature might be used to detect loiterers for example or monitor valuable equipment.

**Note:** You can not enable Cross Counting when PID, LCD or SOD are enabled and vice versa.

Camera	Setup	Switch	Sensitivity	Scene
IP Cam1		<input type="checkbox"/>	3	Indoor
IP Cam2		<input type="checkbox"/>	3	Indoor
IP Cam3		<input type="checkbox"/>	3	Indoor
IP Cam4		<input type="checkbox"/>	3	Indoor

Alarm Apply

#### Camera

Lists all compatible AI cameras on the recorder.

#### Stationary Object Configuration

You can create up to 4 stationary object areas per camera as shown in the [SOD Setup](#)<sup>172</sup> section by clicking the **Cog** icon. You will need to define at least one area so that the recorder knows where to monitor.

Please note that SOD will only be enabled whenever smart detection features are active as specified in the [Smart Schedule](#)<sup>195</sup>.

#### Enabling SOB

To enable or disable SOB for each camera just tick or untick the **Switch** check box.

## Sensitivity

By setting the **Sensitivity** you can avoid false triggers or capture slight movements.

**1** is the lowest sensitivity level and will only trigger when there is a large, clearly noticeable object is introduced or removed from the SOD area. Setting a low sensitivity level can prevent false triggers for something like a tree or bush moving in the wind.

**4** is the highest sensitivity level and will trigger when small objects are introduced or removed from the SOD area. High sensitivity levels are more suited to internal cameras away from environmental conditions.

## Scene

You should set the **Scene** to match where the camera has been installed. Setting the Scene correctly allows the recorder to make allowances for typical light levels and produce more accurate results. You can choose between **Indoor** or **Outdoor** from the **Scene** drop down list to best suit the camera's installation.

## Alarm Handling

Clicking the **Alarm** button will open the Alarm Handling screen where you can set what actions the recorder will take when a stationary object alert is triggered. For more information on setting up alarm handling see the [Alarm Menu - Smart](#)<sup>(226)</sup> section.

## Saving Changes

When you are happy with the current settings click the **Apply** button to save your changes. If you exit the window without saving any changes will be lost.

### 9.7.3.1 Video Menu - Smart - SOD Setup

When you click a camera's **Setup** icon in the [SOD](#)<sup>(171)</sup> sub-menu the SOD Setup screen will be displayed.

In the SOD setup screen you can create up to 4 stationary object areas so that you can monitor when objects are introduced into or removed from them.

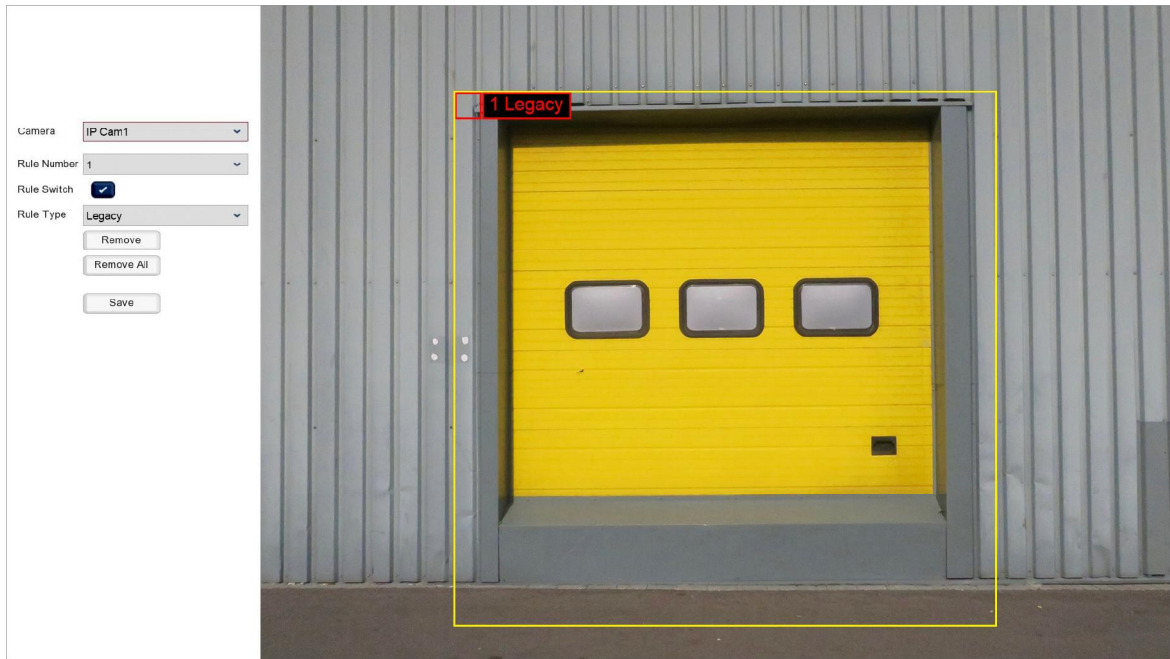

### Selecting Your Camera

You can select the camera you want to configure stationary object areas for from **Camera** drop down list.

### Selecting A Stationary Object Area

You can create and configure up to 4 stationary object areas for each camera. These stationary object configurations are called **Rules**. You can select which Rule you want to create or edit by selecting it from the **Rule Number** drop down list.

To make things easier you can quickly tell which stationary object area belongs to which Rule as it has a red Rule Number in the top left corner of the defined area.

### Creating A Stationary Object Area

To create a stationary object area just follow these easy steps:

1. Select the Rule Number you want to create the stationary object area for from the Rule Number drop down list.
2. Click on the camera's image where you want to set the top left corner of the stationary object area.
3. Click where you want to set the bottom left corner.
4. Click where you want to set the bottom right corner.
5. Finally click where you want to set the top right corner of the stationary object area.

You will notice as you are setting your corner points the recorder will draw a yellow box between the points.



### Editing A Stationary Object Area

You can edit an existing stationary object area as followed:

1. Select the Rule Number you want to edit the stationary object area for from the Rule Number drop down list.
2. Click the red square in the top left corner of the stationary object area.
3. Click and drag the 4 corners to reposition them.
4. Click the red square in the top left corner to confirm and set the new positions.

### Enabling And Disabling Individual Stationary Object Areas

You can turn each of the camera's 4 Rules **On** or **Off** independently as and when they are needed as described below:

1. Select the Rule Number you want to turn On/Off from the Rule Number drop down list.
2. Using the **Rule Switch** check box you can then turn the rule **On** (ticked) or **Off** (unticked).

### Trigger When An Object Is Introduced, Removed Or Both

There are 3 options as to what action will trigger SOD. We call these options **Rule Types**.

To choose a Rule Type first select the Rule Number you want configure then select a Rule Type as described below from the **Rule Type** drop down list.

- **Legacy** - This option will only trigger when an object moves into the stationary object area and remains there.
- **Lost** - This option will only trigger when an object which was originally inside the stationary object area is removed.
- **Lost & Legacy** - This option will trigger either when an object moves into the stationary object area and remains or when an object is removed.

### Deleting Stationary Object Areas

You have 2 options when removing stationary object areas from a camera; you can remove individual areas or all areas as explained below:

#### Remove Individual Stationary Object Areas

To remove a stationary object area click the **Red Square** in the top left corner of the area to select it and then click the **Remove** button to delete it.

#### Remove All Stationary Object Areas

To remove all stationary object areas from the chosen camera simply click the **Remove All** button.





### Saving Changes

When you are happy with the current settings click the **Save** button. If you exit the window without saving any changes will be lost.



### 9.7.4 Video Menu - Smart - PD

The PD (Pedestrian Detection) feature lets you monitor the camera's image for pedestrians, vehicles or both. You can even tell the recorder to watch for moving or stationary subjects depending on your need.

Camera	Setup	Switch		
IP Cam1		<input type="checkbox"/>		
IP Cam2		<input type="checkbox"/>		
IP Cam3		<input type="checkbox"/>		
IP Cam4		<input type="checkbox"/>		

Alarm Apply

#### Camera

Lists all compatible AI cameras on the recorder.

#### Pedestrian Detection Configuration

You can configure the parameters for detection to get more accurate results as shown in the [PD Setup](#)<sup>(176)</sup> section by clicking the **Cog** icon. You will need to define the detection area so that the recorder knows where to monitor.

Please note that PD will only be enabled whenever smart detection features are active as specified in the [Smart Schedule](#)<sup>(195)</sup>.

#### Enabling PD

To enable or disable PD for each camera just tick or untick the **Switch** check box.

#### Alarm Handling

Clicking the **Alarm** button will open the Alarm Handling screen where you can set what actions the recorder will take when a pedestrian detection alert is triggered. For more information on setting up alarm handling see the [Alarm Menu - Smart](#)<sup>(226)</sup> section.

## Saving Changes

When you are happy with the current settings click the **Apply** button to save your changes. If you exit the window without saving any changes will be lost.

### 9.7.4.1 Video Menu - Smart - PD Setup

When you click a camera's **Setup** icon in the [PD](#)<sup>175</sup> sub-menu the PD Setup screen will be displayed.

In the PD setup screen you can select an area of the camera's image you want to monitor for pedestrians, vehicles or both.

The **Snapshot** parameters are only relevant for NVRs as they have extra functionality designed specifically for the IP AI cameras.

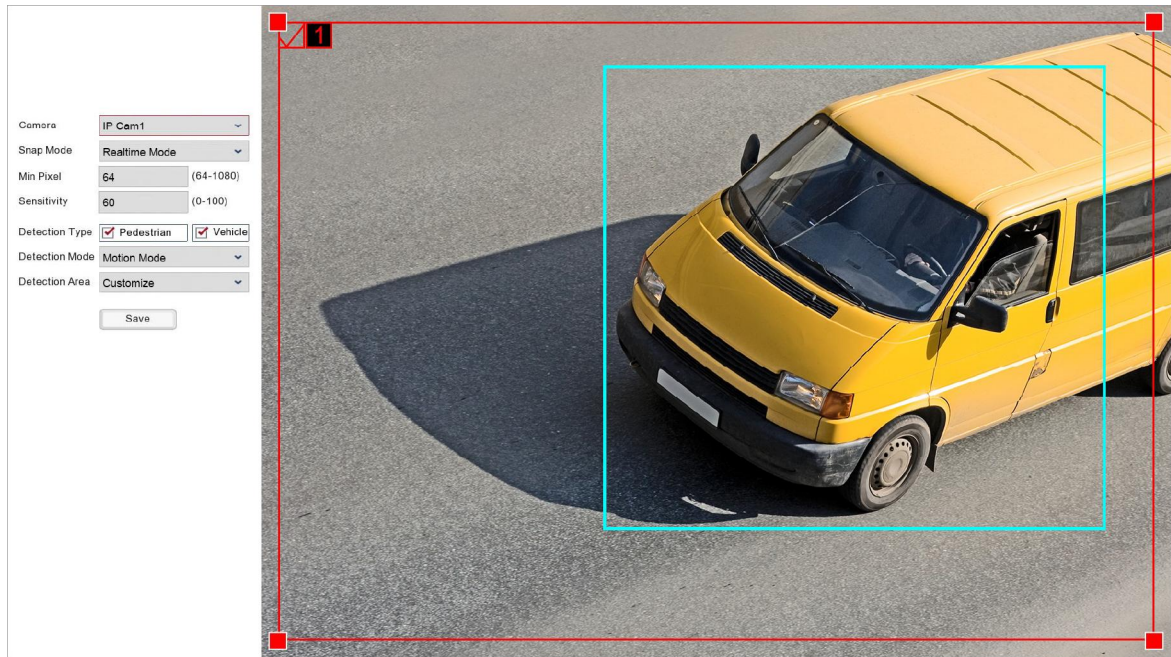

## Selecting Your Camera

You can select the camera you want to configure the detection area for from **Camera** drop down list.

## Creating A Detection Area

Creating a detection area allows you to specify a portion of the camera's image to monitor rather than the entire screen. To create a detection area just follow these easy steps:

1. Click on the camera's image where you want to set the top left corner of the detection area.
2. Click where you want to set the bottom left corner.
3. Click where you want to set the bottom right corner.

4. Finally click where you want to set the top right corner of the detection area.

You will notice as you are setting your corner points the recorder will draw a red box between the points.

### Editing A Detection Area

You can edit the existing detection area by simply dragging any of the red corner squares to where they are required.

### Determining When Thumbnail Snapshots Are Captured

You can determine how the recorder will capture thumbnail snapshots when a person or vehicle is detected using the **Snap Mode** drop down list.

**Default:** Will only capture a snapshot when subjects are first detected. Additional thumbnail snapshots will only be captured if the subject leaves the camera's image and returns

**Realtime:** Will only capture a snapshot when subjects are first detected. Additional thumbnail snapshots will only be captured if the subject leaves the camera's image and returns.

**Interval Mode:** Will allow you to specify how many and how often thumbnail snapshots are captured using the **Snap Num** and **Snap Frequency** fields.

### Number Of Snapshots

You can set how many snapshots are captured for each subject using the **Snap Num** field.

**1:** Will capture a single snapshot when the subject is first detected.

**2:** Will capture a snapshot when the subject is first detected and 1 further snapshot after the period of time specified in the Snap Frequency field if the subject is still present.

**3:** Will capture a snapshot when the subject is first detected and 2 further snapshots, 1 each time the duration specified in the Snap Frequency field elapses and the subject is still present.

**Unlimited:** Will continuously capture snapshots each time the duration specified in the Snap Frequency field elapses and the subject is still present.

### Snapshot Frequency

You can set how often the recorder will capture a snapshot of the subject using the Snap Frequency field. Enter the amount of time (in seconds) you want between each snapshot to set the snap frequency.

This timer will remain active as long as the subject is present. If the subject leaves the camera's image and returns a snapshot will be captured and the timer will start over.

### Minimum Size Of Objects Detected

You can set the minimum size of objects that are detected in the **Min Pixel** field. You can enter a minimum width between 64 pixels to 1080 pixels.

This is useful as the area you are monitoring will differ from camera to camera. If the area you are monitor is far from the camera you would want to set a small minimum width as pedestrians and vehicles will appear small on-screen. However, if the area you are monitoring is fairly close to the camera so that pedestrians and vehicles appear quite large you can set a higher minimum width to avoid false triggers.

### Detection Sensitivity

By setting the **Sensitivity** you can avoid false triggers or capture slight movements. You can enter a sensitivity level between 0 and 100.

**0** is the lowest sensitivity level and will only trigger when the camera gets a perfect, clear view of the subject so that the recorder can tell with a high degree of accuracy that the object is a pedestrian or vehicle. This will avoid false triggers but could miss triggers as the object was in the ideal position or in the best lighting.

**100** is the highest sensitivity level and will trigger when the recorder thinks that any object could possibly be a pedestrian or vehicle. This is handy when the camera may only see the subject for a brief moment or the view may be partially obscured. However, this is a trade off as setting a high sensitivity could result in false triggers.

### Pedestrians, Vehicles Or Both

By setting the **Detection Type** you can choose what the recorder looks for in the camera's image. You can tell the recorder to look for pedestrians, vehicles or both by ticking or unticking the **Pedestrian** or **Vehicle** check boxes.

### Stationary Pedestrians And Vehicles

The **Detection Mode** drop down list allows you to monitor for stationary subjects as well as moving ones.

By default it will be set to **Motion Mode** which will only detect moving pedestrians and vehicles. This is ideal in areas where there might be parked cars so that they don't continue to trigger when they are stationary.

In some circumstances you may wish to also capture stationary pedestrians and vehicles such as no loitering or no parking areas. If this is the case you can select **Static Mode** from the drop down list. The recorder will still trigger when moving subjects are detected but will now capture stationary ones as well.

### Full Screen Monitoring

You can set a detection area as described previously but in some cases you may just want to monitor the entire image. You can do this using the **Detection Area** drop down list. **Customize** will only monitor within the defined detection area but if you select **Full Screen** the recorder will monitor the entire image.

### Saving Changes

When you are happy with the current settings click the **Save** button. If you exit the window without saving any changes will be lost.

### 9.7.5 Video Menu - Smart - FD

The FD (Face Detection) feature allows you to monitor the cameras's image for human faces.

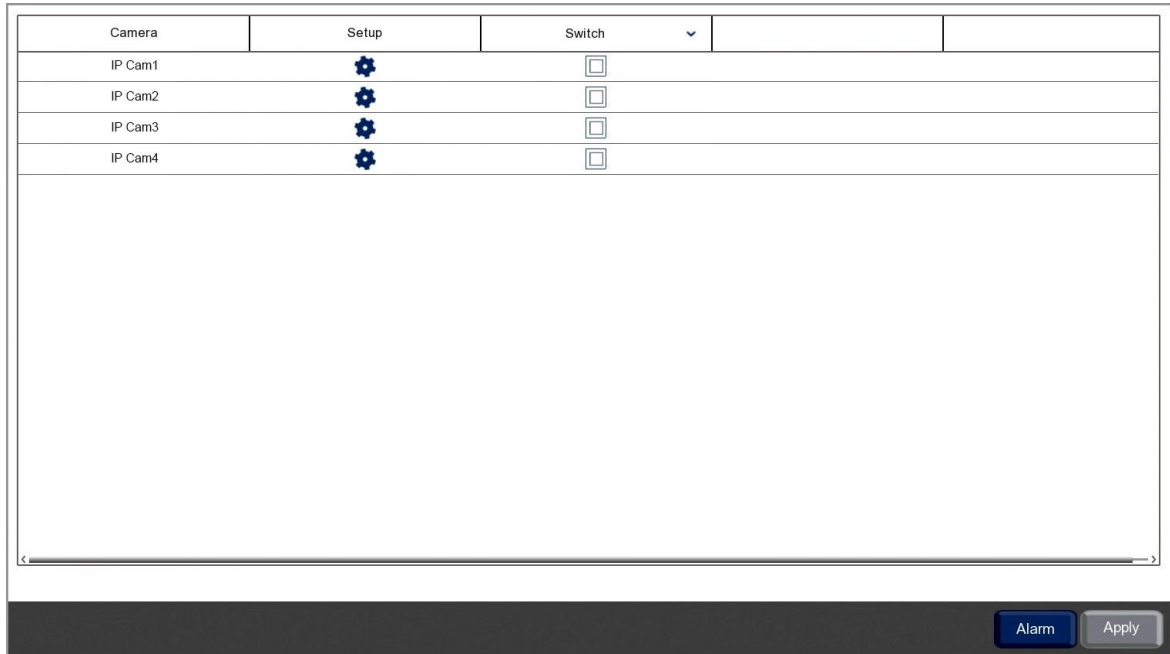

#### Camera

Lists all compatible AI cameras on the recorder.

#### Face Detection Configuration

You can configure the parameters for detection to get more accurate results as shown in the [FD Setup](#)<sup>(181)</sup> section by clicking the **Cog** icon. You will need to define the detection area so that the recorder knows where to monitor.

Please note that FD will only be enabled whenever smart detection features are active as specified in the [Smart Schedule](#)<sup>(195)</sup>.

#### Enabling FD

To enable or disable FD for each camera just tick or untick the **Switch** check box.

#### Alarm Handling

Clicking the **Alarm** button will open the Alarm Handling screen where you can set what actions the recorder will take when a face detection alert is triggered. For more information on setting up alarm handling see the [Alarm Menu - Smart](#)<sup>(226)</sup> section.

## Saving Changes

When you are happy with the current settings click the **Apply** button to save your changes. If you exit the window without saving any changes will be lost.

### 9.7.5.1 Video Menu - Smart - FD Setup

When you click a camera's **Setup** icon in the [FD](#)<sup>(180)</sup> sub-menu the FD Setup screen will be displayed.

In the FD setup screen you can select an area of the camera's image you want to monitor for people's faces.

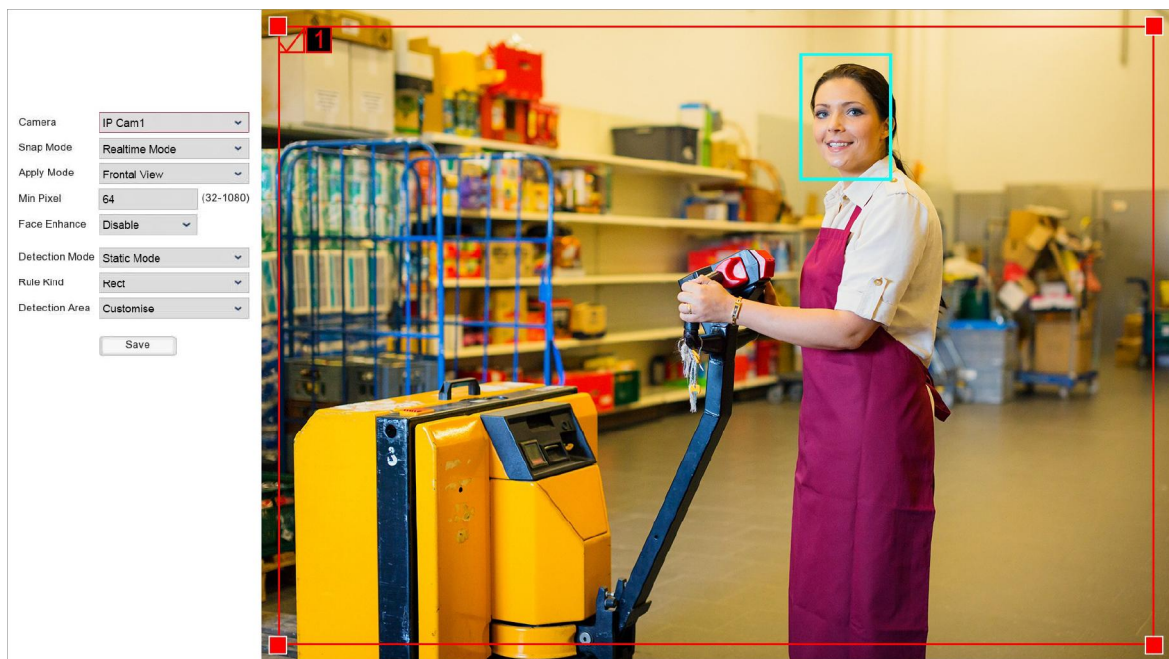

## Selecting Your Camera

You can select the camera you want to configure the detection area for from **Camera** drop down list.

## Creating A Detection Area

Creating a detection area allows you to specify a portion of the camera's image to monitor rather than the entire screen. You have two options when creating a detection area, you can define a box and monitor within it or draw a line a monitor as people cross over it.

### Face Detection Within A Specified Box

To create a boxed detection area follow these easy steps:

1. Set the **Rule Kind** drop down list to **Rect**.
2. Set the **Detection Area** drop down list to **Customise**.



3. Click on the camera's image where you want to set the top left corner of the detection area.
4. Click where you want to set the bottom left corner.
5. Click where you want to set the bottom right corner.
6. Finally click where you want to set the top right corner of the detection area.

You will notice as you are setting your corner points the recorder will draw a red box between between the points.

### Face Detection When Crossing A Line

You can set up face detection to only trigger when somebody crosses over a line to better control when faces are captured. You can even set which direction the line is crossed before a capture so you can monitor for face on entry or as people exit. To set up line crossing face detection follow these simple steps:

1. Set the **Rule Kind** drop down list to **Line**.
2. Click on the camera's image where you want to start the line crossing.
3. Click where you want to stop the line crossing.
4. Finally select which direction a person crosses the line before face detection is triggered from the **Rule Type** drop down list, from side **A** to **B** (**A->B**) or from side **B** to **A** (**B->A**).

You will notice as you are setting your points the recorder will draw a yellow line between them.

### Editing A Detection Area

You can edit the existing detection area by simply dragging any of the red corner squares to where they are required.

### Determining When Thumbnail Snapshots Are Captured

You can determine how the recorder will capture thumbnail snapshots when a face is detected using the **Snap Mode** drop down list.

**Default:** Will only capture a snapshot when the face are first detected. Additional thumbnail snapshots will only be captured if the person leaves the camera's image and returns.

**Realtime:** Will only capture a snapshot from just before the face leaves the image.

**Interval Mode:** Will allow you to specify how many and how often thumbnail snapshots are captured using the **Snap Num** and **Snap Frequency** fields.

### Number Of Snapshots

You can set how many snapshots are captured for each face using the **Snap Num** field.

**1:** Will capture a single snapshot when the face is first detected.

**2:** Will capture a snapshot when the face is first detected and 1 further snapshot after the period of time specified in the Snap Frequency field if the face is still present.

**3:** Will capture a snapshot when the face is first detected and 2 further snapshots, 1 each time the duration specified in the Snap Frequency field elapses and the face is still present.



**Unlimited:** Will continuously capture snapshots each time the duration specified in the Snap Frequency field elapses and the face is still present.

### Snapshot Frequency

You can set how often the recorder will capture a snapshot of each face using the Snap Frequency field. Enter the amount of time (in seconds) you want between each snapshot to set the snap frequency.

This timer will remain active as long as the face is present. If the person leaves the camera's image and returns a snapshot will be captured and the timer will start over.

### Minimum Size Of Objects Detected

You can set the minimum size of objects that are detected in the **Min Pixel** field. You can enter a minimum width between 64 pixels to 1080 pixels.

This is useful as the area you are monitoring will differ from camera to camera. If the area you are monitor is far from the camera you would want to set a small minimum width as pedestrians and vehicles will appear small on-screen. However, if the area you are monitoring is fairly close to the camera so that pedestrians and vehicles appear quite large you can set a higher minimum width to avoid false triggers.

### Mug Shots Or Any Angle

For the most accurate face detection a straight on mug shot is usually the best option but the Zip AI cameras are also capable of detecting a face from most angles.

Depending on the installation a straight on shot may not be possible. You can choose your viewing angle from the **Apply Mode** drop down list as described below:

#### Frontal View

Great for entrances and corridors Frontal View optimises the camera for straight on face detection.

#### Multi Angle

Ideal for general surveillance Multi Angle optimises the camera so that it can also detect faces at various angles.

#### Customise

Selecting customise unlocks 4 extra settings so that you set up bespoke detection angles to suit your requirements as described below:

- **Roll Range** - is how far somebody can tilt their head (ear towards their shoulder) and still be detected as a face. You can set the angle from 0 degrees so that a face would have to be perfectly straight to 180 degrees so that the face can be tilted 90 degrees to either side.
- **Pitch Range** - is how far a person can look up or down and still be detected. At 0 degrees the subject would have to be looking directly at the camera. At 180 degrees the subject can be looking towards the ground or towards the sky and could still be detected.
- **Yaw Range** - is how far somebody can be looking to the side and still be detected. At 0 degrees the subject would have to be looking directly at the camera. At 180 degrees the subject can be side on to the camera and could still be detected.

### Snap Frequency

You can set how often the recorder will capture a snapshot of the subject using the Snap Frequency field. Enter the amount of time (in seconds) you want between each snapshot to set the snap frequency.

This timer will remain active as long as the subject is present. If the subject leaves the camera's image and returns a snapshot will be captured and the timer will start over.

### Minimum Size Of Objects Detected

You can set the minimum size of objects that are detected in the **Min Pixel** field. You can enter a minimum width between 64 pixels to 1080 pixels.

This is useful as the area you are monitoring will differ from camera to camera. If the area you are monitor is far from the camera you would want to set a small minimum width as pedestrians and vehicles will appear small on-screen. However, if the area you are monitoring is fairly close to the camera so that pedestrians and vehicles appear quite large you can set a higher minimum width to avoid false triggers.

### Detection Sensitivity

By setting the **Sensitivity** you can avoid false triggers or capture slight movements. You can enter a sensitivity level between 0 and 100.

**0** is the lowest sensitivity level and will only trigger when the camera gets a perfect, clear view of the subject so that the recorder can tell with a high degree of accuracy that the object is a pedestrian or vehicle. This will avoid false triggers but could miss triggers as the object was in the ideal position or in the best lighting.

**100** is the highest sensitivity level and will trigger when the recorder thinks that any object could possibly be a pedestrian or vehicle. This is handy when the camera may only see the subject for a brief moment or the view may be partially obscured. However, this is a trade off as setting a high sensitivity could result in false triggers.

### Pedestrians, Vehicles Or Both

By setting the **Detection Type** you can choose what the recorder looks for in the camera's image. You can tell the recorder to look for pedestrians, vehicles or both by ticking or unticking the **Pedestrian** or **Vehicle** check boxes.

### Stationary Pedestrians And Vehicles

The **Detection Mode** drop down list allows you to monitor for stationary subjects as well as moving ones.

By default it will be set to **Motion Mode** which will only detect moving pedestrians and vehicles. This is ideal in areas where there might be parked cars so that they don't continue to trigger when they are stationary.

In some circumstances you may wish to also capture stationary pedestrians and vehicles such as no loitering or no parking areas. If this is the case you can select **Static Mode** from the drop down list. The recorder will still trigger when moving subjects are detected but will now capture stationary ones as well.

### Full Screen Monitoring

You can set a detection area as described previously but in some cases you may just want to monitor the entire image. You can do this using the **Detection Area** drop down list. **Customize** will only monitor within the defined detection area but if you select **Full Screen** the recorder will monitor the entire image.

### Saving Changes

When you are happy with the current settings click the **Save** button. If you exit the window without saving any changes will be lost.

### 9.7.6 Video Menu - Smart - CC

The CC (Cross Counting) feature can be thought of as a more advanced version of Line Crossing Detection (LCD). As well as triggering an alarm when a object crosses over a line, Cross Counting will keep a record of how many times the line has been crossed.

For example this could be used to check how many customers have entered a shop over a specific period or how many cars use a car park on a daily basis.

Once you have Cross Counting configured you can inspect the results in the [Intelligent Analysis](#)<sup>197</sup> sub-menu.

**Note:** You can not enable Cross Counting when PID, LCD or SOD are enabled and vice versa.

Camera	Setup	Switch	Sensitivity	Scene
IP Cam1		<input checked="" type="checkbox"/>	3	Indoor
IP Cam2		<input checked="" type="checkbox"/>	3	Indoor
IP Cam3		<input checked="" type="checkbox"/>	3	Indoor
IP Cam4		<input checked="" type="checkbox"/>	3	Indoor

Alarm Apply

#### Camera

Lists all compatible AI cameras on the recorder.

#### Cross Counting Configuration

You can create 1 cross counting line per camera as shown in the [CC Setup](#)<sup>187</sup> section by clicking the **Cog** icon. You will need to define the line so that the recorder knows where to monitor.

Please note that CC will only be enabled whenever smart detection features are active as specified in the [Smart Schedule](#)<sup>195</sup>.

#### Enabling CC

To enable or disable CC for each camera just tick or untick the **Switch** check box.

## Sensitivity

By setting the **Sensitivity** you can avoid false triggers or capture slight movements.

**1** is the lowest sensitivity level and will only trigger when there is a large amount of movement where something clearly crosses over the line. Setting a low sensitivity level can prevent false triggers for something like a tree or bush moving in the wind.

**4** is the highest sensitivity level and will trigger with the slightest movement over the line. High sensitivity levels are more suited to internal cameras away from environmental conditions.

## Scene

You should set the **Scene** to match where the camera has been installed. Setting the Scene correctly allows the recorder to make allowances for typical light levels and produce more accurate results. You can choose between **Indoor** or **Outdoor** from the **Scene** drop down list to best suit the camera's installation.

## Alarm Handling

Clicking the **Alarm** button will open the Alarm Handling screen where you can set what actions the recorder will take when a line is crossed. For more information on setting up alarm handling see the [Alarm Menu - Smart<sup>\(226\)</sup>](#) section.

## Saving Changes

When you are happy with the current settings click the **Apply** button to save your changes. If you exit the window without saving any changes will be lost.

### 9.7.6.1 Video Menu - Smart - CC - Setup

When you click a camera's **Setup** icon in the [CC<sup>\(186\)</sup>](#) sub-menu the CC Setup screen will be displayed.

In the CC setup screen you can create up a line crossing which allows you to monitor or retrospectively analyse movement across this imaginary barrier.

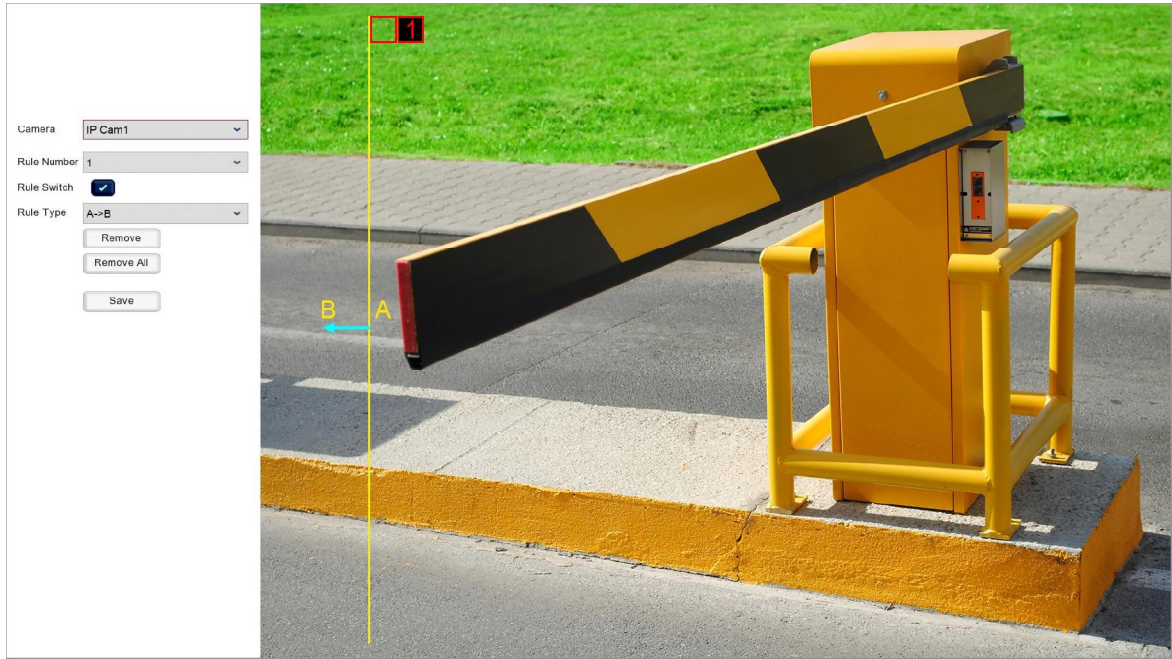

### Selecting Your Camera

You can select the camera you want to configure cross counting for from **Camera** drop down list.

### Selecting A Line Crossing

Currently you can only create 1 cross counting line per camera. These cross counting configurations are called **Rules**. You can select which Rule you want to create or edit by selecting it from the **Rule Number** drop down list.

To make things easier you can quickly tell which cross counting belongs to which Rule as it has a red Rule Number at the start of the line.

### Creating A Cross Counting Line

To create a cross counting just follow these easy steps:

1. Select the Rule Number you want to create the line crossing for from the Rule Number drop down list.
2. Click on the camera's image where you want to start the cross counting line.
3. Click where you want to stop the cross counting line.

You will notice as you are setting your points the recorder will draw a yellow line between them.

### Editing A Cross Counting Line

You can edit an existing cross counting line as followed:

1. Select the Rule Number you want to edit the line crossing for from the Rule Number drop down list.
2. Click the red square at the start of the line.
3. Click and drag the the start and end points to reposition them.

4. Click the red square at the start of the line to confirm and set the new positions.

### Choosing Which Direction Of Line Crossing Causes A Trigger

There are 2 options as to what direction of movement will trigger CC. We call these options **Rule Types**.

For simplicity we label the area on one side of the line **A** and the area on the other side of the line **B**. The direction of movement is also indicated by the light blue arrow in the middle of the line. To choose a Rule Type first select the Rule Number you want configure then select a Rule Type as described below from the **Rule Type** drop down list.

- **A->B** - This option will only trigger when an object moves across the line from side A to side B.
- **B->A** - This option will only trigger when an object moves across the line from side B to side A.

### Deleting Cross Counting Lines

You have 2 options when removing cross counting lines from a camera; you can remove individual lines or all lines as explained below. As you can currently only create 1 cross counting line both methods will have the same effect:

#### Remove Cross Counting Lines

To remove a cross counting line click the **Red Square** at the start of the line to select it and then click the **Remove** button to delete it.

#### Remove All Line Crossings

To remove all cross counting lines from the chosen camera simply click the **Remove All** button.

### Saving Changes

When you are happy with the current settings click the **Save** button. If you exit the window without saving any changes will be lost.

### 9.7.7 Video Menu - Smart - Sound Detection

The Sound Detection feature allows you to determine what actions the recorder takes when there is an increase or decrease in the sound levels on a camera's audio.

Camera	Switch <input type="checkbox"/>	Rise <input type="checkbox"/>	Rise Sensitivity	Sound Intensity	Decline <input type="checkbox"/>	Decline Sensitivity	Schedule
IP Cam1	<input type="checkbox"/>	Disable <input type="checkbox"/>	50	50	Disable <input type="checkbox"/>	50	
IP Cam2	<input type="checkbox"/>	Disable <input type="checkbox"/>	50	50	Disable <input type="checkbox"/>	50	
IP Cam3	<input type="checkbox"/>	Disable <input type="checkbox"/>	50	50	Disable <input type="checkbox"/>	50	
IP Cam4	<input type="checkbox"/>	Disable <input type="checkbox"/>	50	50	Disable <input type="checkbox"/>	50	

#### Camera

Lists all compatible AI cameras on the recorder.

#### Enabling Sound Detection

To enable or disable Sound Detection for each camera just tick or untick the **Switch** check box.

Please note that Sound Detection will only be enabled whenever smart detection features are active as specified in the [Smart Schedule](#)<sup>195</sup>.

#### Trigger When Sound Levels Increase

You can set the recorder to trigger when there is an increase in a camera's sound levels by setting the **Rise** drop down list to **Enable**.

You can then use the **Rise Sensitivity** field to set threshold for what the recorder determines as large enough increase in sound levels to produce a trigger. This can be handy in areas with regular background noise to prevent constant triggers.

1 is the lowest sensitivity level and will only trigger when there is a very loud noise.

100 is the highest sensitivity level and will trigger when there is a slight increase in sound levels.



## Trigger When Sound Levels Decrease

You can set the recorder to trigger when there is a drop in a camera's sound levels by setting the **Decline** drop down list to **Enable**. This is especially useful in commercial and industrial settings as an alert if equipment or machinery stops working.

You can use the **Decline Sensitivity** field to set threshold for what the recorder determines as large enough drop in sound levels to produce a trigger. This can be handy in areas with ever changing background noise to prevent constant triggers.

1 is the lowest sensitivity level and will only trigger when there is a large drop in sound levels.

100 is the highest sensitivity level and will trigger when there is the slightest drop in sound levels.

## Sound Intensity

The Sound Intensity is how loud the noise has to be for the recorder to monitor it. This allows you to account for constant background noise depending on the environment.

1 is the lowest sensitivity level so Sound Detection will only trigger when a loud noise increases or decreases.

100 is the highest sensitivity level so Sound Detection will trigger even when a quiet noise increases or decreases.

## Setting Up A Sound Detection Schedule

You can setup an arming schedule for the sound detection of each camera individually as explained in the [Sound Detection Schedule](#)<sup>(191)</sup> section.

## Alarm Handling

Clicking the **Alarm** button will open the Alarm Handling screen where you can set what actions the recorder will take when a sound detection alert is triggered. For more information on setting up alarm handling see the [Alarm Menu - Smart](#)<sup>(228)</sup> section.

## Saving Changes

When you are happy with the current settings click the **Apply** button to save your changes. If you exit the window without saving any changes will be lost.

### 9.7.7.1 Video Menu - Smart - Sound Detection - Schedule

When you click a camera's **Schedule** icon in the [Sound Detection](#)<sup>(190)</sup> sub-menu the Sound Detection Schedule screen will be displayed.

Here you can create a tailor made arming schedule for sound detection that suits your requirements. For example you could create a schedule so that sound detection is only active outside business our when a premises should be empty.

The schedule displays the time of day in half hour segments along the top and the day of the week down the side.

Active times are shown in blue and inactive times are shown in white. By default the entire schedule will be coloured in blue indicating that sound detection is active 24 hours a day, 7 days a week.

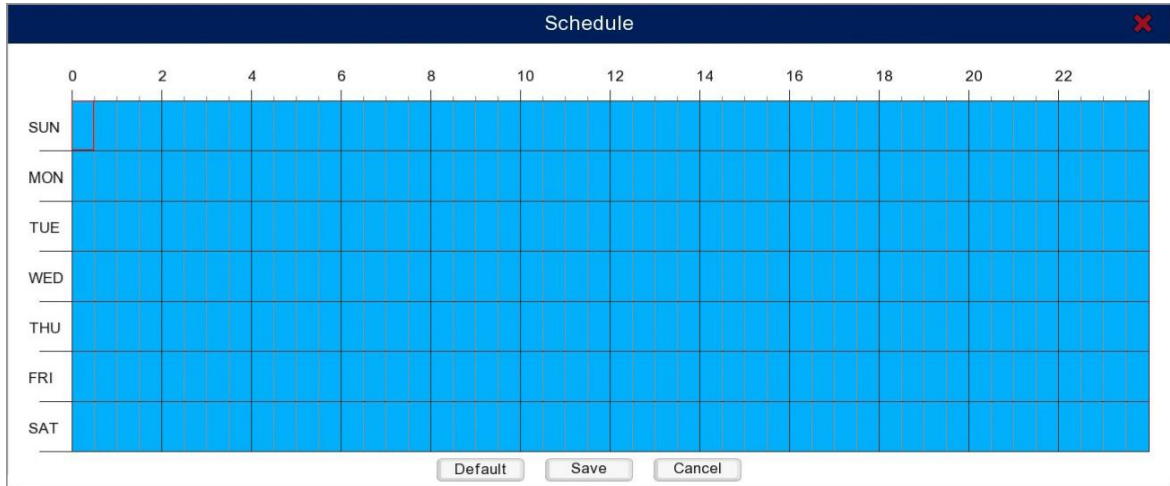

### Editing The Sound Detection Schedule

To select or de-select a half hour segment simply click it with the mouse.

Alternatively you can change the state of multiple segments over multiple days by clicking and dragging over them.

### Restoring Default Settings

You can restore the sound detection schedule to its default state by clicking the **Default** button.

### Saving Changes

When you are happy with the current settings click the **Save** button.

To exit the schedule screen without saving changes click the **Cancel** button.

### 9.7.8 Video Menu - Smart - Lens Covered

The Lens Covered feature allows you to determine what actions the recorder takes when the camera's image is obscured.

Camera	Switch	Sensitivity	
IP Cam1	<input checked="" type="checkbox"/>	3	▼
IP Cam2	<input checked="" type="checkbox"/>	3	▼
IP Cam3	<input checked="" type="checkbox"/>	3	▼
IP Cam4	<input checked="" type="checkbox"/>	3	▼

#### Camera

Lists all compatible AI cameras on the recorder.

#### Enabling Lens Covered Detection

To enable or disable Lens Covered Detection for each camera just tick or untick the **Switch** check box.

Please note that Lens Covered Detection will only be enabled whenever smart detection features are active as specified in the [Smart Schedule](#)<sup>195</sup>.

#### Sensitivity

The Sensitivity level dictates how much of the camera's image has to be obscured before lens cover is triggered.

1 is the lowest sensitivity level and will only trigger when the entire image is obscured.

6 is the highest sensitivity level and will trigger when only a small portion of the camera's image is obscured.

### Alarm Handling

Clicking the **Alarm** button will open the Alarm Handling screen where you can set what actions the recorder will take when a lens covered detection alert is triggered. For more information on setting up alarm handling see the [Alarm Menu - Smart<sup>\(226\)</sup>](#) section.

### Saving Changes

When you are happy with the current settings click the **Apply** button to save your changes. If you exit the window without saving any changes will be lost.

### 9.7.9 Video Menu - Smart - Schedule

In the Schedule sub-menu you can create an arming schedule for each camera to specify when the Smart features are active.

The schedule displays the time of day in half hour segments along the top and the day of the week down the side.

Active times are shown in blue and inactive times are shown in white. By default the entire schedule will be coloured in blue indicating that sound detection is active 24 hours a day, 7 days a week.

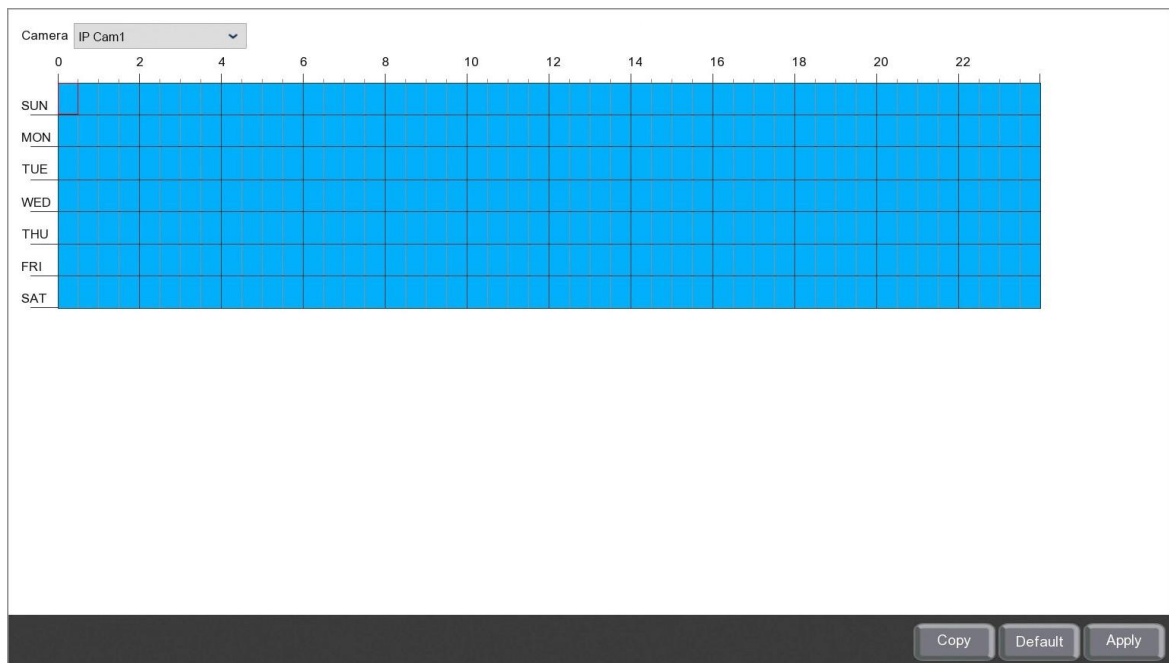

#### Choosing A Camera

You can choose which camera you want to configure a schedule for from the **Camera** drop down list.

#### Editing A Schedule

To select or de-select a half hour segment simply click it with the mouse.

Alternatively you can change the state of multiple segments over multiple days by clicking and dragging over them.

#### Restoring Default Settings

You can restore a schedule to its default state by clicking the **Default** button.

### Copying A Schedule From 1 Camera To Another

To save time you can copy schedules from one camera to another as explained in the [Parameter Copy](#)<sup>319</sup> section.

### Saving Changes

When you are happy with the current settings click the **Save** button.

### 9.7.10 Video Menu - Smart - Intelligent Analysis

In the Intelligent Analysis screen you can generate reports on the number of objects which have passed over a [Cross Counting](#)<sup>(186)</sup> line within a specified time period.

You can create daily, weekly, monthly or annual reports for each AI camera.

Hour	Count(Cross In)
00:00 - 00:59	2
01:00 - 01:59	4
02:00 - 02:59	3
03:00 - 03:59	4
04:00 - 04:59	7
05:00 - 05:59	11
06:00 - 06:59	15
07:00 - 07:59	21
08:00 - 08:59	24
09:00 - 09:59	23
10:00 - 10:59	18
11:00 - 11:59	19
12:00 - 12:59	25
13:00 - 13:59	26
14:00 - 14:59	22
15:00 - 15:59	17
16:00 - 16:59	18

#### How To Generate A Report

To generate a report follow these simple steps:

1. Select the camera you want to generate the report for from the **Camera** drop down list.
2. Choose the type of report you want to generate from the **Report Type** drop down list; Daily, Weekly, Monthly or Annual.
3. Next you need to decide whether you want search for objects crossing the line and entering into the area of concern (A->B) or objects crossing back over the line and out of the of concern (B->A). This is done from the **Cross Type** drop down list by selecting Cross In or Cross Out.
4. Select the date you want the report to start from by clicking the **Calendar** icon in the **Start Date** field.
5. Once everything is set as required click the **Search** button.

#### Exporting A Report

You have the option to export reports as CSV spreadsheets by clicking the **Export** button. For more information on exporting reports see the [Backup](#)<sup>(317)</sup> section.

## Record Menu

The Record menu is where you can configure the recording parameters and the recording schedules for each camera connected to the Zip recorder.

Camera	StreamType	Resolution	FPS	Video Encode Type	Bitrate Control	Video Quality	Bitrate Mode	Bitrate
Cam1	Normal	1280 x 1440	16	H.265	VBR	Medium	Predefined	2048
Cam2	Normal	1920 x 1080	13	H.265	VBR	Medium	Predefined	2048
Cam3	Normal	1280 x 1944	14	H.265	VBR	Medium	Predefined	2048
Cam4	Normal	1920 x 1080	13	H.265	VBR	Medium	Predefined	2048
Cam5	Normal	1280 x 1944	14	H.265	VBR	Medium	Predefined	2048
Cam6	Normal	1920 x 1080	13	H.265	VBR	Medium	Predefined	2048
Cam7	Normal	960 x 576	25	H.265	VBR	Medium	Predefined	2048
Cam8	Normal	1920 x 1080	13	H.265	VBR	Medium	Predefined	2048
Cam9	Normal	1920 x 1080	13	H.265	VBR	Medium	Predefined	2048
Cam10	Normal	1920 x 1080	13	H.265	VBR	Medium	Predefined	2048
Cam11	Normal	1920 x 1080	13	H.265	VBR	Medium	Predefined	2048
Cam12	Normal	1920 x 1080	13	H.265	VBR	Medium	Predefined	2048
Cam13	Normal	1920 x 1080	13	H.265	VBR	Medium	Predefined	2048
Cam14	Normal	1920 x 1080	13	H.265	VBR	Medium	Predefined	2048
Cam15	Normal	1920 x 1080	13	H.265	VBR	Medium	Predefined	2048
Cam16	Normal	1920 x 1080	10	H.265	VBR	Medium	Predefined	2048
W Cam1	Normal	1920 x 1080	20	H.264	CBR		User-defined	540

From the Record menu you can access the following sub-menus and features.

### Encode

In the [Encode sub-menu](#)<sup>(199)</sup> you can set up the video parameters for the mainstream, substream and mobilestream.

### Record

The [Record sub-menu](#)<sup>(209)</sup> allows you to set what is recorded and when.

### Capture

From The [Capture sub-menu](#)<sup>(213)</sup> you can choose what snapshots are captured and when.



## 10.1 Record - Encode

From the Encode sub-menu you can manage the video parameters for the Mainstream, Substream and Mobile-stream.

### 10.1.1 Record - Encode - Mainstream

You can tailor the mainstream recording quality of each camera to suit your requirements in the Encode - Mainstream sub-menu; whether you are needing to record at the highest quality possible, for the longest time possible or somewhere in between.

The mainstream is the video stream which will be recorded to the hard drive so the quality you set up here is the quality of the footage stored.

The settings available will differ depending on recorder, camera type and camera model.

Camera	StreamType	Resolution	FPS	Video Encode Type	Bitrate Control	Video Quality	Bitrate Mode	Bitrate	Volume	I Frame Interval	ETR
Cam1	Normal	1280 x 1440	16	H.265	VBR	Medium	Predefined	2048	<input type="checkbox"/>		<input checked="" type="checkbox"/>
Alarm	Alarm	1280 x 1440	16	H.264	CBR		Predefined	2048	<input type="checkbox"/>		
Cam2	Normal	1920 x 1080	13	H.265	VBR	Medium	Predefined	2048	<input type="checkbox"/>		<input type="checkbox"/>
Cam3	Normal	1280 x 1944	14	H.265	VBR	Medium	Predefined	2048	<input type="checkbox"/>		<input type="checkbox"/>
Cam4	Normal	1920 x 1080	13	H.265	VBR	Medium	Predefined	2048	<input type="checkbox"/>		<input type="checkbox"/>
Cam5	Normal	1280 x 1944	14	H.265	VBR	Medium	Predefined	2048	<input type="checkbox"/>		<input type="checkbox"/>
Cam6	Normal	1920 x 1080	13	H.265	VBR	Medium	Predefined	2048	<input type="checkbox"/>		<input type="checkbox"/>
Cam7	Normal	990 x 576	25	H.265	VBR	Medium	Predefined	2048	<input type="checkbox"/>		<input type="checkbox"/>
Cam8	Normal	1920 x 1080	13	H.265	VBR	Medium	Predefined	2048	<input type="checkbox"/>		<input type="checkbox"/>
Cam9	Normal	1920 x 1080	13	H.265	VBR	Medium	Predefined	2048	<input type="checkbox"/>		<input type="checkbox"/>
Cam10	Normal	1920 x 1080	13	H.265	VBR	Medium	Predefined	2048	<input type="checkbox"/>		<input type="checkbox"/>
Cam11	Normal	1920 x 1080	13	H.265	VBR	Medium	Predefined	2048	<input type="checkbox"/>		<input type="checkbox"/>
Cam12	Normal	1920 x 1080	13	H.265	VBR	Medium	Predefined	2048	<input type="checkbox"/>		<input type="checkbox"/>
Cam13	Normal	1920 x 1080	13	H.265	VBR	Medium	Predefined	2048	<input type="checkbox"/>		<input type="checkbox"/>
Cam14	Normal	1920 x 1080	13	H.265	VBR	Medium	Predefined	2048	<input type="checkbox"/>		<input type="checkbox"/>
Cam15	Normal	1920 x 1080	13	H.265	VBR	Medium	Predefined	2048	<input type="checkbox"/>		<input type="checkbox"/>
Cam16	Normal	1920 x 1080	10	H.265	VBR	Medium	Predefined	2048	<input type="checkbox"/>		<input type="checkbox"/>

Total Band Width:32Mbps, Used Band Width 27.5Mbps

Copy Default Apply

### Camera

Lists all channels on the recorder.

### Stream Type

The stream type allows you to set different recording qualities for regular recording and alarm triggers. The **Normal** type is the everyday recording and **Alarm** is the recording parameters the recorder will switch to when an alarm is triggered.

This feature is usually used to save on storage space as you can set the Normal recording quality to a lower standard for general surveillance and then increase the recording quality when an event occurs and an alarm is triggered.

**Note:** To display the parameters for the Alarm recording you will first need to tick the check box for **ETR**.

## Resolution

You can set the recording resolution for each camera from the **Resolution** drop down list. The resolutions available will depend on the camera.

A higher resolution will record higher quality footage but takes up more storage space.

## Frames Per Second (FPS)

The frame rate is how many images are captured per second and determines how smooth your recorded footage appears. You can set the frame rate in the FPS drop down list.

A higher frame rate produces smoother footage but takes up more storage space. For example TV shows are usually filmed at 24 frames per second however this is unnecessary for most CCTV Systems. A frame rate of 12 frames per second would still capture 12 high resolution images every second.

## Video Encode Type

The video encoding type is the compression technique used when recording footage and can be set in the **Video Encode Type** drop down list.

**H.265** is a clever compression technique that is twice as effective as H.264. This means you can effectively record at double the quality or for twice as long using the same storage space.

However, you may wish to record using **H.264** encoding if you plan on backing up footage to watch on a device that doesn't support H.265 encoded video files.

## Bitrate Control

The bitrate is simply the amount of data transferred per second so the higher the bitrate the higher the quality of the image produced.

You have two options to choose from in the **Bitrate Control** drop down list, **VBR** or **CBR**.

**VBR (Variable Bit Rate)** - allows the bitrate to change based on the complexity of the image. This means the bitrate can increase or decrease when needed which could produce higher quality video however it can take longer to process as there is more work involved. VBR will use the bitrate set in the Bitrate column as a starting point and then adjust as required.

**CBR (Constant Bit Rate)** - allows you to set a specific bitrate used for recording. Files are easier to process but the encoding is less flexible as the bitrate doesn't change irrespective of how much or how little action is taking place in the camera's image. CBR will use the bitrate set in the Bitrate column when capturing images.

## Video Quality

If you set the Bitrate Control to VBR the **Video Quality** drop down list will become available. From here you can set your desired video quality and the recorder will then capture what is achievable based on the current main stream configuration.

You have 6 options when choosing the Video Quality; **Lowest**, **Lower**, **Low**, **Medium**, **Higher** and **Highest**.

This needs to be used hand in hand with other mainstream settings to get the best results. For example if you set the Video Quality to Highest but have a low bitrate you will still capture low quality footage.

### Bitrate & Bitrate Mode

How you set the **Bitrate Mode** changes the options available when setting the **Bitrate**.

If you set the Birate Mode as **Predifined** you can then choose one of the commonly used pre-set bitrates from the **Bitrate** drop down list.

When you set the Bitrate Mode to **User-defined** you can manually enter a specific bitrate into the **Bitrate** column.

Just remember that the bitrate is the amount of data transferred per second so a high bitrate will produce a high quality image with a larger file size. A low bitrate will produce a low quality image with a smaller file size.

### Enabling Audio

You can enable or disable audio recording for each channel by ticking or unticking the **Volume** check box.

### I Frame Interval

I Frames is a compression technique used to create smaller video files. It works by taking one key frame called an I Frame which the recorder will then use as a reference point. For each frame after the I Frame the recorder will only capture parts of the image which have changed rather than capturing the entire image.

With the **I Frame Interval** you set how often a new I Frame is captured by setting the number of frames between each I Frame. Setting the interval too low and the I Frame will become ineffective as there is such a short time between each reference point. On the other hand, if the interval is too high so much may have changed between the I Frame and the current frame that the recorder is effectively capturing and entire new image anyway.

As a rule of thumb we recommend setting the I Frame Interval at double the frame rate so that a new I Frame is captured every 2 seconds.

For example if the frame rate is 12 frame per second (FPS) the I Frame Interval would be set as 24 so that the recorder captures a new I Frame every 24 frames.

### Event Triggered Recording (ETR)

ETR allows you to use different recording settings when an alarm is triggered compared to normal recordings. This is usually used to increase the video quality so that you have the best footage possible when an event occurs.

Ticking the **ETR** check box for a camera will display a new row of settings below the camera with the stream type **Alarm**. These are the record settings for when an alarm is triggered and can be configured in the same way as the normal stream.

### Copying Stream Settings From One Camera To Another

Rather than re-entering the same settings for each camera you can copy settings from one camera by clicking the **Copy** button. For more information on copying settings see the [Parameter Copy](#)<sup>319</sup> section.

### Defaulting Settings

You can restore settings back to their default value by clicking the **Default** button.

### Saving Changes

Once you are happy with your settings click the **Apply** button to save them. Alternatively you can right click with the mouse to exit the Mainstream menu without saving changes.

### 10.1.2 Record - Encode - Substream

You can configure the substream quality for each camera in the Encode - Substream sub-menu.

The substream allows you to create a lower quality stream for each camera which can then be used when viewing the recorder remotely in the PC client software or the mobile app. As remote viewing is done via the internet the quality of the video relies on your internet speed. Trying to view multiple HD cameras from the mainstream on slower broadband or mobile internet connections can result in stuttering, jerky images. To combat this the lower quality, less demanding substream could be used for smooth video monitoring.

The recorder will always record the higher quality mainstream so you will always have high quality footage if needed. However the substream is also recorded by default and can be selected during playback to overcome performance issues when viewing remotely if required. If substream recording is not needed it can be turned off to save on disk space as described in the [Record](#)<sup>209</sup> sub-menu section.

The settings available will differ depending on recorder, camera type and camera model.

Camera	StreamType	Resolution	FPS	Video Encode Type	Bitrate Control	Bitrate Mode	Bitrate	Volume	I Frame Interval
Cam1	Normal	704 x 576	5	H.265	CBR	Predefined	512	<input type="checkbox"/>	
Cam2	Normal	704 x 576	5	H.265	CBR	Predefined	512	<input type="checkbox"/>	
Cam3	Normal	704 x 576	5	H.265	CBR	Predefined	512	<input type="checkbox"/>	
Cam4	Normal	704 x 576	5	H.265	CBR	Predefined	512	<input type="checkbox"/>	
Cam5	Normal	704 x 480	5	H.265	CBR	Predefined	512	<input type="checkbox"/>	
Cam6	Normal	704 x 576	5	H.265	CBR	Predefined	512	<input type="checkbox"/>	
Cam7	Normal	704 x 576	5	H.265	CBR	Predefined	512	<input type="checkbox"/>	
Cam8	Normal	704 x 576	5	H.265	CBR	Predefined	512	<input type="checkbox"/>	
Cam9	Normal	704 x 576	5	H.265	CBR	Predefined	512	<input type="checkbox"/>	
Cam10	Normal	704 x 576	5	H.265	CBR	Predefined	512	<input type="checkbox"/>	
Cam11	Normal	704 x 576	5	H.265	CBR	Predefined	512	<input type="checkbox"/>	
Cam12	Normal	704 x 576	5	H.265	CBR	Predefined	512	<input type="checkbox"/>	
Cam13	Normal	704 x 576	5	H.265	CBR	Predefined	512	<input type="checkbox"/>	
Cam14	Normal	704 x 576	5	H.265	CBR	Predefined	512	<input type="checkbox"/>	
Cam15	Normal	704 x 576	5	H.265	CBR	Predefined	512	<input type="checkbox"/>	
Cam16	Normal	704 x 576	5	H.265	CBR	Predefined	512	<input type="checkbox"/>	
W Cam1	Normal	640 x 368	20	H.264	CBR	User-defined	64	<input type="checkbox"/>	

Total Band Width: 32Mbps, Used Band Width: 26.25Mbps

Copy Default Apply

#### Camera

Lists all channels on the recorder.

#### Stream Type

As the substream is not recorded and ETR is not available and only the Normal **Stream Type** is available.

#### Resolution

You can set the recording resolution for each camera from the **Resolution** drop down list. The resolutions available will depend on the camera.

## Frames Per Second (FPS)

The frame rate is how many images are captured per second and determines how smooth your recorded footage appears. You can set the frame rate in the FPS drop down list.

A higher frame rate produces smoother footage but takes up more storage space. For example TV shows are usually filmed at 24 frames per second however this is unnecessary for most CCTV Systems. A frame rate of 12 frames per second would still capture 12 high resolution images every second.

## Video Encode Type

The video encoding type is the compression technique for the video footage and can be set in the **Video Encode Type** drop down list.

**H.265** is a clever compression technique that is twice as effective as **H.264**. This means you can effectively stream at double the quality while still using the same bandwidth.

However, you may wish to record using **H.264** encoding if you are viewing the stream on a device which doesn't support **H.265**.

## Bitrate Control

The bitrate is simply the amount of data transferred per second so the higher the bitrate the higher the quality of the image produced.

You have two options to choose from in the **Bitrate Control** drop down list, **VBR** or **CBR**.

**VBR (Variable Bit Rate)** - allows the bitrate to change based on the complexity of the image. This means the bitrate can increase or decrease when needed which could produce higher quality video however it can take longer to process as there is more work involved. VBR will use the bitrate set in the Bitrate column as a starting point and then adjust as required.

**CBR (Constant Bit Rate)** - allows you to set a specific bitrate used for recording. Files are easier to process but the streaming is less flexible as the bitrate doesn't change irrespective of how much or how little action is taking place in the camera's image. CBR will use the bitrate set in the Bitrate column when streaming images.

## Video Quality

If you set the Bitrate Control to VBR the **Video Quality** drop down list will become available. From here you can set your desired video quality and the recorder will then stream what is achievable based on the current main stream configuration.

You have 6 options when choosing the video quality; **Lowest, Lower, Low, Medium, Higher** and **Highest**.

This needs to be used hand in hand with other substream settings to get the best results. For example if you set the video quality to Highest but have a low bitrate you will still only see low quality footage.

## Bitrate & Bitrate Mode

How you set the **Bitrate Mode** changes the options available when setting the **Bitrate**.

If you set the Birate Mode as **Predifined** you can then choose one of the commonly used pre-set bitrates from the **Bitrate** drop down list.

When you set the Bitrate Mode to **User-defined** you can manually enter a specific bitrate into the **Bitrate** column.

## Enabling Audio

You can enable or disable audio recording for each channel by ticking or unticking the **Volume** check box.

## I Frame Interval

I Frames is a compression technique used to create smaller video files. It works by taking one key frame called an I Frame which the recorder will then use as a reference point. For each frame after the I Frame the recorder will only capture parts of the image which have changed rather than capturing the entire image.

With the **I Frame Interval** you set how often a new I Frame is captured by setting the number of frames between each I Frame. Setting the interval too low and the I Frame will become ineffective as there is such a short time between each reference point. On the other hand, if the interval is too high so much may have changed between the I Frame and the current frame that the recorder is effectively capturing and entire new image anyway.

As a rule of thumb we recommend setting the I Frame Interval at double the frame rate so that a new I Frame is captured every 2 seconds.

For example if the frame rate is 12 frame per second (FPS) the I Frame Interval would be set as 24 so that the recorder captures a new I Frame every 24 frames.

## Copying Stream Settings From One Camera To Another

Rather than re-entering the same settings for each camera you can copy settings from one camera by clicking the **Copy** button. For more information on copying settings see the [Parameter Copy](#)<sup>319</sup> section

## Saving Changes

Once you are happy with your settings click the **Apply** button to save them. Alternatively you can right click with the mouse to exit the Mainstream menu without saving changes.

### 10.1.3 Record - Encode - Mobilestream

You can configure the mobilestream quality for compatible IP cameras in the Encode - Mobilestream sub-menu. The settings for mobilestreams are saved on the camera and not the recorder. As only IP cameras have this functionality you will only be able to configure mobilestreams for IP cameras.

The mobilestream allows you to create a low quality stream for each camera which is optimised for viewing the recorder from the mobile app. As mobile internet connections can be slow in some areas trying to view multiple HD images can be difficult. By creating a low resolution stream you are still able to view multiple cameras at one time on limited bandwidth. Often the difference between the mainstream and mobilestream isn't too noticeable when viewed on a mobile device as screen is so small.

The recorder will always record the higher quality mainstream so you will always have high quality footage if needed. The mobilestream is simply there to overcome performance issues when viewing remotely if required.

The settings available will differ depending on recorder, camera type and camera model.

Camera	Switch	StreamType	Resolution	FPS	Video Encode Type	Bitrate Mode	Bitrate	Volume	I Frame Interval
IP Cam1	<input checked="" type="checkbox"/>	Normal	640 x 480	10	H.264	Predefined	256	<input checked="" type="checkbox"/>	20
IP Cam2	<input checked="" type="checkbox"/>	Normal	640 x 480	10	H.264	Predefined	256	<input checked="" type="checkbox"/>	20
IP Cam3	<input checked="" type="checkbox"/>	Normal	640 x 480	10	H.264	Predefined	256	<input checked="" type="checkbox"/>	20
IP Cam4	<input checked="" type="checkbox"/>	Normal	640 x 480	10	H.264	Predefined	256	<input checked="" type="checkbox"/>	20

Total Band Width:32Mbps, Used Band Width:26.25Mbps

Apply

### Camera

Lists all channels on the recorder.

### Enabling & Disabling The Mobilestream

You can enable or disable the mobilestream for each camera by ticking or unticking the **Switch** check box.

When the mobile stream is enabled on a camera, the mobilestream option will become available when choosing the stream type for that camera on the Zip Vision PC client software or mobile app.



## Stream Type

As the mobilestream is not recorded and ETR is not available only the Normal **Stream Type** is available.

## Resolution

You can set the recording resolution for each camera from the **Resolution** drop down list. The resolutions available will depend on the camera.

## Frames Per Second (FPS)

The frame rate is how many images are captured per second and determines how smooth your recorded footage appears. You can set the frame rate in the FPS drop down list.

A higher frame rate produces smoother footage but takes up more storage space. For example TV shows are usually filmed at 24 frames per second however this is unnecessary for most CCTV Systems. A frame rate of 12 frames per second would still capture 12 high resolution images every second.

## Video Encode Type

The video encoding type is the compression technique for the video footage and can be set in the **Video Encode Type** drop down list.

**H.265** is a clever compression technique that is twice as effective as **H.264**. This means you can effectively stream at double the quality while still using the same bandwidth.

However, you may wish to record using **H.264** encoding if you are viewing the stream on a device which doesn't support **H.265**.

## Bitrate & Bitrate Mode

How you set the **Bitrate Mode** changes the options available when setting the **Bitrate**.

If you set the Bitrate Mode as **Predefined** you can then choose one of the commonly used pre-set bitrates from the **Bitrate** drop down list.

When you set the Bitrate Mode to **User-defined** you can manually enter a specific bitrate into the **Bitrate** column.

Just remember that the bitrate is the amount of data transferred per second so a high bitrate will produce a high quality image which requires a faster internet speed. A low bitrate will produce a low quality image better for slower internet speeds.

## Enabling Audio

You can enable or disable audio recording for each channel by ticking or unticking the **Volume** check box.

## I Frame Interval

I Frames is a compression technique used to create smaller video files. It works by taking one key frame called an I Frame which the recorder will then use as a reference point. For each frame after the I Frame the recorder will only capture parts of the image which have changed rather than capturing the entire image.

With the **I Frame Interval** you set how often a new I Frame is captured by setting the number of frames between each I Frame. Setting the interval too low and the I Frame will become ineffective as there is such a short time between each reference point. On the other hand, if the interval is too high so much may have changed between the I Frame and the current frame that the recorder is effectively capturing and entire new image anyway.

As a rule of thumb we recommend setting the I Frame Interval at double the frame rate so that a new I Frame is captured every 2 seconds.

For example if the frame rate is 12 frame per second (FPS) the I Frame Interval would be set as 24 so that the recorder captures a new I Frame every 24 frames.

## Saving Changes

Once you are happy with your settings click the **Apply** button to save them. Alternatively you can right click with the mouse to exit the Mainstream menu without saving changes.

## 10.2 Record - Record

In the Record sub-menu you can set which channels and which streams are recorded. Once you have chosen which channels to record you can set up a [Recording Schedule](#)<sup>(211)</sup> to specify what to record for each channel and when.

The settings available will differ depending on recorder, camera type and camera model.

Camera	Record Switch	Stream Mode	PreRecord
Cam1	<input checked="" type="checkbox"/>	DualStream	<input checked="" type="checkbox"/>
Cam2	<input checked="" type="checkbox"/>	DualStream	<input checked="" type="checkbox"/>
Cam3	<input checked="" type="checkbox"/>	DualStream	<input checked="" type="checkbox"/>
Cam4	<input checked="" type="checkbox"/>	DualStream	<input checked="" type="checkbox"/>
Cam5	<input checked="" type="checkbox"/>	DualStream	<input checked="" type="checkbox"/>
Cam6	<input checked="" type="checkbox"/>	DualStream	<input checked="" type="checkbox"/>
Cam7	<input checked="" type="checkbox"/>	DualStream	<input checked="" type="checkbox"/>
Cam8	<input checked="" type="checkbox"/>	DualStream	<input checked="" type="checkbox"/>
Cam9	<input checked="" type="checkbox"/>	DualStream	<input checked="" type="checkbox"/>
Cam10	<input checked="" type="checkbox"/>	DualStream	<input checked="" type="checkbox"/>
Cam11	<input checked="" type="checkbox"/>	DualStream	<input checked="" type="checkbox"/>
Cam12	<input checked="" type="checkbox"/>	DualStream	<input checked="" type="checkbox"/>
Cam13	<input checked="" type="checkbox"/>	DualStream	<input checked="" type="checkbox"/>
Cam14	<input checked="" type="checkbox"/>	DualStream	<input checked="" type="checkbox"/>
Cam15	<input checked="" type="checkbox"/>	DualStream	<input checked="" type="checkbox"/>
Cam16	<input checked="" type="checkbox"/>	DualStream	<input checked="" type="checkbox"/>
W Cam1	<input checked="" type="checkbox"/>	DualStream	<input checked="" type="checkbox"/>
IP Cam1	<input checked="" type="checkbox"/>	DualStream	<input checked="" type="checkbox"/>

### Camera

Lists all channels on the recorder.

### Enabling And Disabling Recording

You can enable or disable recording for each channel individually by ticking or unticking the **Record Switch** check box.

Please note that this only tells the recorder that these channels are OK to record footage. You still need to create a [Record Schedule](#)<sup>(211)</sup> to tell the recorder when to record footage. Without a Record Schedule the recorder won't record any footage.

### Choosing Which Stream To Record

You can select which stream to record for each camera from the **Stream Mode** drop down list.

**DualStream** will record both the high quality mainstream and the lower quality substream. This is handy if you plan to playback footage remotely over the internet via the Zip Vision PC client software or mobile app. When playing back footage you can select the less demanding substream for smooth playback on slower internet connections.

**Mainstream** will only record the high quality mainstream. If you don't intend on playing footage back remotely then a recording of the lower quality substream is not required. By recording the mainstream only you can save on disk space which would usually be taken up by the substream.

### Enabling Pre-recording

Some features on the recorder such as motion detection allow you to specify a pre-record time. This is an amount of time the recorder will capture footage for before an event trigger occurred. For example, if you set a motion detection pre-record time of 30 seconds and motion detection is triggered, the recorder will capture the motion trigger plus the 30 seconds before the trigger so you can see the build up to the event.

You can enable or disable pre-recording by ticking or unticking the **PreRecord** check box.

### Copying Record Settings From One Camera To Another

Rather than re-entering the same settings for each camera you can copy settings from one camera to another by clicking the **Copy** button. For more information on copying settings see the [Parameter Copy](#)<sup>(319)</sup> section.

### Defaulting Settings

You can restore settings back to their default value by clicking the **Default** button.

### Saving Changes

Once you are happy with your settings click the **Apply** button to save them. Alternatively you can right click with the mouse to exit the Mainstream menu without saving changes.

## 10.2.1 Record - Record Schedule

From the Record Schedule sub-menu you can create a unique timetable to tell the recorder when to capture footage. You can also choose how recordings are captured. This could be when motion is detected, when an alarm is triggered or constant recording between certain hours.

As an example you could create a schedule which captures constant footage during busy business hours, then switches to just motion or alarm triggered recording at night when nobody is around. This would avoid wasting disk space capturing hours of footage where nothing happens during the night.



### Camera

Select the camera you want to create the recording schedule for from the **Camera** drop down list.

### Recording Types

For maximum flexibility you can create individual recording schedules for **Normal** constant recording, **Motion** detection triggered recording and **Alarm** triggered recording. To edit a schedule first click one of the coloured radio buttons to the right of the schedule to select the recording type you want to configure.

### Editing A Schedule

By default each of the 3 recording types are scheduled to be active 24 hours a day, 7 days a week.

### Removing A Schedule

To remove a schedule follow these simple steps:

1. Click the coloured radio button for the recording type you want to remove.
2. Click and drag over the time period you want to remove the scheduled recording from. You can drag over multiple days at once if needed.

### Creating A Schedule

To create a schedule or add to an existing schedule follow these simple steps:

1. Click the coloured radio button for the recording type you want to create the schedule for.

2. Click and drag over the time period you want to schedule recording for. You can drag over multiple days at once if needed.

### Copying Record Schedules From One Camera To Another

Rather than re-creating the same schedule for each camera you can copy schedules from one camera to another by clicking the **Copy** button. For more information on copying schedules see the [Parameter Copy](#)<sup>(319)</sup> section.

### Defaulting Settings

You can restore settings back to their default value by clicking the **Default** button.

### Saving Changes

Once you are happy with your schedules click the **Apply** button to save them. Alternatively you can right click with the mouse to exit the Record Schedule screen without saving changes.

## 10.3 Record - Capture

In the Capture sub-menu you can configure each camera to take snapshots at set intervals. This is great for time-lapsing images or low level monitoring where a video isn't necessarily required. Once you have configured your capture settings can create a [Capture Schedule](#)<sup>(216)</sup> to control when snapshots are captured.

The settings available will differ depending on recorder, camera type and camera model.

Camera	Auto Capture	Stream Type	Normal Interval	Alarm Interval	Alarm Resolution	Alarm Quality
Cam1	<input type="checkbox"/>	Mainstream	5 s	5 s	1280 x 720	Medium
Cam2	<input type="checkbox"/>	Mainstream	5 s	5 s	1920 x 1080	Medium
Cam3	<input type="checkbox"/>	Mainstream	5 s	5 s	1280 x 720	Medium
Cam4	<input type="checkbox"/>	Mainstream	5 s	5 s	1920 x 1080	Medium
Cam5	<input type="checkbox"/>	Mainstream	5 s	5 s	1280 x 720	Medium
Cam6	<input type="checkbox"/>	Mainstream	5 s	5 s	1920 x 1080	Medium
Cam7	<input type="checkbox"/>	Mainstream	5 s	5 s	960 x 576	Medium
Cam8	<input type="checkbox"/>	Mainstream	5 s	5 s	1920 x 1080	Medium
Cam9	<input type="checkbox"/>	Mainstream	5 s	5 s	1920 x 1080	Medium
Cam10	<input type="checkbox"/>	Mainstream	5 s	5 s	1920 x 1080	Medium
Cam11	<input type="checkbox"/>	Mainstream	5 s	1 Hour	1920 x 1080	Medium
Cam12	<input type="checkbox"/>	Mainstream	5 s	1 Hour	1920 x 1080	Medium
Cam13	<input type="checkbox"/>	Mainstream	5 s	5 s	1920 x 1080	Medium
Cam14	<input type="checkbox"/>	Mainstream	5 s	5 s	1920 x 1080	Medium
Cam15	<input type="checkbox"/>	Mainstream	5 s	5 s	1920 x 1080	Medium
Cam16	<input type="checkbox"/>	Mainstream	5 s	5 s	1920 x 1080	Medium
W Cam1	<input type="checkbox"/>	Mainstream	5 s	5 s		
IP Cam1	<input type="checkbox"/>	Mainstream	5 s	5 s		

⚠️ Digital channel maximum capture resolution is 1080P

Copy Default Apply

### Camera

Lists all channels on the recorder.

### Enabling And Disabling Snapshot Capturing

To enable or disable snapshot capturing for each channel individually by ticking or unticking the **Auto Capture** check box.

Please note that this only tells the recorder that these channels are OK to capture snapshots. You still need to create a [Capture Schedule](#)<sup>(216)</sup> to tell the recorder when to capture snapshots. Without a Capture Schedule the recorder won't capture any snapshots.

### Choosing Which Stream To Take Snapshots From

You can select which stream the snapshots are taken from for each channel using the **Stream Type** drop down list, **Mainstream** or **Substream**.

The snapshot quality will depend on the stream settings in the [Mainstream](#)<sup>(199)</sup> or [Substream](#)<sup>(203)</sup> encoding screens.

## Setting How Often Snapshots Are Captured

You can choose how often the recorder will capture snapshots for each channel from the **Normal Interval** drop down list. The interval between snapshots can be set from 5 seconds to 1 hour.

A snapshot will be captured after every interval as long as **Normal** capturing is active in the [Capture Schedule](#)<sup>(216)</sup> for the required camera.

## Capturing Snapshots On An Alarm Trigger Or Motion Detection

A handy feature for capturing snapshots on a Zip recorder is the ability to set a different capture interval for when an alarm is triggered or motion is detected by the camera. This is typically used to increase the capture frequency so that you have more images of an event.

This can be set in the **Alarm Interval** drop down list and just like the Normal Interval the interval between snapshots can be set from 5 seconds to 1 hour.

Snapshots will only be captured using the Alarm Interval as long as **Alarm** and/or **Motion** capturing is active in the [Capture Schedule](#)<sup>(216)</sup> for the required camera.

## Setting The Resolution For Alarm And Motion Snapshot Captures

The resolution of the alarm and motion snapshots can be set differently to the main or substream resolution which is used for the normal snapshots. This is done in the **Alarm Resolution** drop down list.

Usually this would be to increase the resolution so that you get high quality snapshots of any events that occur.

## Setting The Image Quality For Alarm And Motion Snapshot Captures

As well as the image resolution of alarm and motion snapshots you can set the image quality in the **Alarm Quality** drop down list.

You have 6 options when choosing the Alarm Quality; **Lowest, Lower, Low, Medium, Higher** and **Highest**.

This needs to be used hand in hand with the Alarm Resolution to get the best results. For example if you set the Alarm Quality to Highest but have a low resolution you will still capture low quality snapshots.

## Copying Capture Settings From One Camera To Another

Rather than re-entering the same settings for each camera you can copy settings from one camera to another by clicking the **Copy** button. For more information on copying settings see the [Parameter Copy](#)<sup>(319)</sup> section.

## Defaulting Settings

You can restore settings back to their default value by clicking the **Default** button.



### **Saving Changes**

Once you are happy with your settings click the **Apply** button to save them. Alternatively you can right click with the mouse to exit the Capture menu without saving changes.

### 10.3.1 Record - Capture Schedule

From the Capture Schedule sub-menu you can create a unique timetable to tell the recorder when to capture snapshots. You can also choose how snapshots are captured. This could be when motion is detected, when an alarm is triggered or constant capturing between certain hours.

As an example you could create a schedule which captures constant snapshots during busy business hours, then switches to just motion or alarm triggered snapshots at night when nobody is around. This would avoid wasting disk space capturing hundreds of snapshots where nothing happens during the night.



#### Camera

Select the camera you want to create the capture schedule for from the **Camera** drop down list..

#### Capture Types

For maximum flexibility you can create individual capture schedules for **Normal** constant snapshot capturing, **Motion** detection triggered snapshot capturing and **Alarm** triggered snapshot capturing. To edit a schedule first click one of the coloured radio buttons to the right of the schedule to select the capture type you want to configure.

#### Editing A Schedule

By default each of the schedule will be blank so that no snapshots are captured.

#### Creating A Schedule

To create a schedule or add to an existing schedule follow these simple steps:

1. Click the coloured radio button for the capture type you want to create the schedule for.
2. Click and drag over the time period you want to schedule snapshot capturing for. You can drag over multiple days at once if needed.

#### Removing A Schedule

To remove a schedule follow these simple steps:

1. Click the coloured radio button for the capture type you want to remove.

2. Click and drag over the time period you want to remove the scheduled snapshot capturing from. You can drag over multiple days at once if needed.

### **Copying Capture Schedules From One Camera To Another**

Rather than re-creating the same schedule for each camera you can copy schedules from one camera to another by clicking the **Copy** button. For more information on copying schedules see the [Parameter Copy](#)<sup>(319)</sup> section

### **Defaulting Settings**

You can restore settings back to their default value by clicking the **Default** button.

### **Saving Changes**

Once you are happy with your schedules click the **Apply** button to save them. Alternatively you can right click with the mouse to exit the Capture Schedule screen without saving changes.

## Alarm Menu

The Alarm menu is where you can set up alarm inputs and instruct the recorder on what to do when an alarm is triggered.



From the Alarm menu you can access the following sub-menus and features.

### Motion

In the [Motion sub-menu](#) <sup>(220)</sup> you can configure motion detection and decide how the recorder handles motion triggers.

### I/O

The [I/O sub-menu](#) <sup>(223)</sup> allows you to set what happens when there is an alarm trigger on one of the recorder's hard wired alarm inputs or the hard wired alarm input on a connected IP camera.

### Smart

The [Smart sub-menu](#) <sup>(226)</sup> lets you set up how the recorder manages smart detection triggers.

- PID - Perimeter Intrusion Detection.
- LCD - Line Crossing Detection.
- SOD - Stationary Object Detection.
- PD - Pedestrian Detection.
- FD - Face Detection.
- CC - Cross Counting.
- Sound Detection.
- Lens Covered.

## PTZ Linkage

The [PTZ Linkage sub-menu](#)<sup>(230)</sup> is another of the Zip's clever features. In this menu you can set up your PTZ cameras to move to certain area when an alarm is triggered or motion is detected on another camera connected to the recorder.

## Exception

The [Exception sub-menu](#)<sup>(233)</sup> is a handy tool that lets you set up alarms and notifications for when the recorder encounters a maintenance problem such as a disk error, a full hard drive or if a camera goes down.

## Alarm Schedule

In the [Alarm Schedule sub-menu](#)<sup>(239)</sup> you can create schedules for each camera to say when alarm outputs, alarm triggered uploads and alarm notifications should be turned on and off.

## 11.1 Alarm Menu - Motion

In the **Motion** sub-menu you can set up how the recorder reacts when motion is detected for each camera. These are also the same options you will see if you click the **Alarm** button when setting up motion detection.

The settings available will differ depending on recorder, camera type and camera model.

Camera	Buzzer	Alarm Out	Latch Time	Record	Post Recording	Show Message	Send Email	FTP Picture Upload	FTP Video Upload	Picture to Cloud	Video to Cloud	Full Screen
Cam1	Disable		10 s		ON	30 s	<input checked="" type="checkbox"/>	<input checked="" type="checkbox"/>	<input checked="" type="checkbox"/>	<input type="checkbox"/>	<input checked="" type="checkbox"/>	<input type="checkbox"/>
Cam2	Disable		10 s		ON	30 s	<input checked="" type="checkbox"/>	<input checked="" type="checkbox"/>	<input checked="" type="checkbox"/>	<input type="checkbox"/>	<input checked="" type="checkbox"/>	<input type="checkbox"/>
Cam3	Disable		10 s		ON	30 s	<input checked="" type="checkbox"/>	<input checked="" type="checkbox"/>	<input checked="" type="checkbox"/>	<input type="checkbox"/>	<input checked="" type="checkbox"/>	<input type="checkbox"/>
Cam4	Disable		10 s		ON	30 s	<input checked="" type="checkbox"/>	<input checked="" type="checkbox"/>	<input checked="" type="checkbox"/>	<input type="checkbox"/>	<input checked="" type="checkbox"/>	<input type="checkbox"/>
Cam5	Disable		10 s		ON	30 s	<input checked="" type="checkbox"/>	<input checked="" type="checkbox"/>	<input checked="" type="checkbox"/>	<input type="checkbox"/>	<input checked="" type="checkbox"/>	<input type="checkbox"/>
Cam6	Disable		10 s		ON	30 s	<input checked="" type="checkbox"/>	<input checked="" type="checkbox"/>	<input checked="" type="checkbox"/>	<input type="checkbox"/>	<input checked="" type="checkbox"/>	<input type="checkbox"/>
Cam7	Disable		10 s		ON	30 s	<input checked="" type="checkbox"/>	<input checked="" type="checkbox"/>	<input checked="" type="checkbox"/>	<input type="checkbox"/>	<input checked="" type="checkbox"/>	<input type="checkbox"/>
Cam8	Disable		10 s		ON	30 s	<input checked="" type="checkbox"/>	<input checked="" type="checkbox"/>	<input checked="" type="checkbox"/>	<input type="checkbox"/>	<input checked="" type="checkbox"/>	<input type="checkbox"/>
Cam9	Disable		10 s		ON	30 s	<input checked="" type="checkbox"/>	<input checked="" type="checkbox"/>	<input checked="" type="checkbox"/>	<input type="checkbox"/>	<input checked="" type="checkbox"/>	<input type="checkbox"/>
Cam10	Disable		10 s		ON	30 s	<input checked="" type="checkbox"/>	<input checked="" type="checkbox"/>	<input checked="" type="checkbox"/>	<input type="checkbox"/>	<input checked="" type="checkbox"/>	<input type="checkbox"/>
Cam11	Disable		10 s		ON	30 s	<input checked="" type="checkbox"/>	<input checked="" type="checkbox"/>	<input checked="" type="checkbox"/>	<input type="checkbox"/>	<input checked="" type="checkbox"/>	<input type="checkbox"/>
Cam12	Disable		10 s		ON	30 s	<input checked="" type="checkbox"/>	<input checked="" type="checkbox"/>	<input checked="" type="checkbox"/>	<input type="checkbox"/>	<input checked="" type="checkbox"/>	<input type="checkbox"/>
Cam13	Disable		10 s		ON	30 s	<input checked="" type="checkbox"/>	<input checked="" type="checkbox"/>	<input checked="" type="checkbox"/>	<input type="checkbox"/>	<input checked="" type="checkbox"/>	<input type="checkbox"/>
Cam14	Disable		10 s		ON	30 s	<input checked="" type="checkbox"/>	<input checked="" type="checkbox"/>	<input checked="" type="checkbox"/>	<input type="checkbox"/>	<input checked="" type="checkbox"/>	<input type="checkbox"/>
Cam15	Disable		10 s		ON	30 s	<input checked="" type="checkbox"/>	<input checked="" type="checkbox"/>	<input checked="" type="checkbox"/>	<input type="checkbox"/>	<input checked="" type="checkbox"/>	<input type="checkbox"/>
W Cam1	Disable		10 s		ON	30 s	<input checked="" type="checkbox"/>	<input checked="" type="checkbox"/>	<input checked="" type="checkbox"/>	<input type="checkbox"/>	<input checked="" type="checkbox"/>	<input type="checkbox"/>

### Camera

Lists all channels on the recorder.

### Audio Warning

The recorder can be set to produce a loud beeping sound when motion is detected on the selected camera. From the **Buzzer** drop down list you can choose the length of time the recorder will sound the audio alarm for. You can also select **Disable** if you don't want the recorder to sound a warning when motion is detected.

### Trigger An Alarm Output

You can tell the recorder to trigger alarm outputs to activate a 3rd party device such as a floodlight when motion is detected by the selected camera. Clicking the **Cog** icon in the **Alarm Out** column will open the Alarm Output window where you can dictate which alarm outputs will be triggered. These can be the recorder's own local alarm outputs, the alarm outputs of connected IP cameras or you can simply select All.

All

Local->1

IP Cam1->1     IP Cam2->1     IP Cam3->1

IP Cam4->1

## Latch Time

The Latch Time is the amount of time the alarm output remains active. You can set the Latch Time up to a maximum of 60 seconds using the drop down list

## Record Video On Motion Trigger

The recorder can be set to capture footage from a single or multiple channels when motion is detected. Typically if motion is detected on camera 1 you would want to record channel 1. This feature however allows you trigger recording on nearby cameras at the same time or all entrances for example.

To set which channels are recorded click the **Cog** icon in the **Record** column to display the Record Channel window.

**Record Channel**

Analogue Channels

IP Camera

1	2	3	4	5	6	7	8	9	10	11	12	13	14	15	16
1	2	3	4	5	6	7	8	9	10	11	12	13	14	15	16
17	18	19	20	21	22										

You can enable or disable channel recording by ticking or unticking the **Record Channel** check box.

You can then choose all analogue or all IP cameras by selecting the **Analogue Channels** and **IP Camera** check boxes. Finally you can select any combination of analogue and IP cameras by highlighting the individual channels.

## Post Recording

The Post Recording time determines how long the recorder continues to capture footage for after the last movement was detected. This gives you a bit of leeway in-case the object which triggered the motion detection moves again or returns.

You can set the post recording time between 30 seconds and 5 minutes using the **Post Recording** drop down list.

## On Screen Notification

When **Show Message** is turned on an icon of a red man will appear in the top right corner of the screen whenever motion is detected. You can turn this feature on or off using the **Show Message** check box.

## Email Notifications

You can set the recorder to include motion triggers in its email reports by selecting the Send Email check box. For more information on setting up emails accounts and email schedules see the [Email](#)<sup>(252)</sup> section in the Network Menu.

## FTP Uploads

You have the option to automatically upload snapshots of motion triggers or video footage covering the incident to an FTP server. You will first need to configure the FTP server connection as described in the [FTP](#)<sup>(257)</sup> section. Once this is set up you can simply select the **FTP Picture Upload** and/or the **FTP Video Upload** check boxes.

## Cloud Uploads

You can also automatically upload snapshots or video footage of motion triggers to a cloud storage account. This can be Dropbox or Google Drive. You will first need to configure your cloud storage account as described in the [Cloud](#)<sup>(270)</sup> section. When you have set up your cloud storage account you can select the **Picture To Cloud** and/or the **Video To Cloud** check boxes.

## Open Full Screen On Motion Trigger

By ticking the **Full Screen** check box you can tell the recorder to open the camera's image full screen when motion is detected. This is useful in control room settings where the cameras are monitored.

## Setting Up Motion Detection

Clicking the **Motion** button will open the Motion Detection screen where you can configure motion detection for each camera. For more information on setting up motion detection see the [Video Menu - Motion](#)<sup>(159)</sup> section.

## Copying Motion Detection Alarm Settings

You can copy motion detection alarm settings from one camera to another by clicking the **Copy** button as explained in the [Parameter Copy](#)<sup>(319)</sup> section.

## Defaulting Settings

To restore settings back to the factory default you can click the **De fault** button.

## Saving Changes

When you are happy with the current settings click the **Apply** button. If you exit the window without saving any changes will be lost.



## 11.2 Alarm Menu - I/O

In the **I/O** (Input/Output) sub-menu you can set what action the recorder takes when there is a trigger on one of the alarm inputs or an alarm input of a connected IP camera.

The settings available will differ depending on recorder, camera type and camera model.

Alarm In	Alarm Type	Buzzer	Alarm Out	Latch Time	Record	Post Recording	Show Message	Send Email	FTP Picture Upload	FTP Video Upload	Picture to Cloud	Video to Cloud	Full Screen
Local<-1	Normally-Open	Disable		10 s		30 s	<input checked="" type="checkbox"/>	<input checked="" type="checkbox"/>	<input checked="" type="checkbox"/>	<input type="checkbox"/>	<input checked="" type="checkbox"/>	<input type="checkbox"/>	<input type="checkbox"/>
Local<-2	Normally-Open	Disable		10 s		30 s	<input checked="" type="checkbox"/>	<input checked="" type="checkbox"/>	<input checked="" type="checkbox"/>	<input type="checkbox"/>	<input checked="" type="checkbox"/>	<input type="checkbox"/>	<input type="checkbox"/>
Local<-3	Normally-Open	Disable		10 s		30 s	<input checked="" type="checkbox"/>	<input checked="" type="checkbox"/>	<input checked="" type="checkbox"/>	<input type="checkbox"/>	<input checked="" type="checkbox"/>	<input type="checkbox"/>	<input type="checkbox"/>
Local<-4	Normally-Open	Disable		10 s		30 s	<input checked="" type="checkbox"/>	<input checked="" type="checkbox"/>	<input checked="" type="checkbox"/>	<input type="checkbox"/>	<input checked="" type="checkbox"/>	<input type="checkbox"/>	<input type="checkbox"/>
IP Cam1<-1	Normally-Close	Disable		10 s		30 s	<input checked="" type="checkbox"/>	<input checked="" type="checkbox"/>	<input checked="" type="checkbox"/>	<input type="checkbox"/>	<input checked="" type="checkbox"/>	<input type="checkbox"/>	<input type="checkbox"/>
IP Cam2<-1	Normally-Close	Disable		10 s		30 s	<input checked="" type="checkbox"/>	<input checked="" type="checkbox"/>	<input checked="" type="checkbox"/>	<input type="checkbox"/>	<input checked="" type="checkbox"/>	<input type="checkbox"/>	<input type="checkbox"/>
IP Cam3<-1	Normally-Close	Disable		10 s		30 s	<input checked="" type="checkbox"/>	<input checked="" type="checkbox"/>	<input checked="" type="checkbox"/>	<input type="checkbox"/>	<input checked="" type="checkbox"/>	<input type="checkbox"/>	<input type="checkbox"/>
IP Cam4<-1	Normally-Close	Disable		10 s		30 s	<input checked="" type="checkbox"/>	<input checked="" type="checkbox"/>	<input checked="" type="checkbox"/>	<input type="checkbox"/>	<input checked="" type="checkbox"/>	<input type="checkbox"/>	<input type="checkbox"/>

### Alarm In

Lists all of the available alarm inputs on the recorder and connected IP cameras.

### Setting The Alarm Type

You can choose the type of alarm input from the **Alarm Type** drop down list.

The Alarm Type will need to match that of the device connected to the input otherwise the recorder will think that the input is being triggered constantly.

You also have the option to disable alarm inputs by setting the Alarm Type to **OFF**.

### Audio Warning

The recorder can be set to produce a loud beeping sound when an alarm input is triggered. From the **Buzzer** drop down list you can choose the length of time the recorder will sound the audio alarm for. You can also select **Disable** if you don't want the recorder to sound a warning when triggered.

### Trigger An Alarm Output

You can tell the recorder to trigger alarm outputs to activate a 3rd party device such as a floodlight when there is an alarm input. Clicking the **Cog** icon in the **Alarm Out** column will open the Alarm Output window where you can set which alarm outputs will be triggered. These can be the recorder's own local alarm outputs, the alarm outputs of connected IP cameras or you can simply select All.

<input type="checkbox"/> All		
<input type="checkbox"/> Local->1		
<input type="checkbox"/> IP Cam1->1	<input type="checkbox"/> IP Cam2->1	<input type="checkbox"/> IP Cam3->1
<input type="checkbox"/> IP Cam4->1		

### Latch Time

The Latch Time is the amount of time the alarm output remains active. You can set the Latch Time up to a maximum of 60 seconds using the drop down list

### Record Video On Alarm Input

The recorder can be set to capture footage from a single or multiple channels when there is an alarm input.

To set which channels are recorded click the **Cog** icon in the **Record** column to display the Record Channel window.

<input checked="" type="checkbox"/> <b>Record Channel</b>																
<input type="checkbox"/> Analogue Channels	1	2	3	4	5	6	7	8	9	10	11	12	13	14	15	16
<input type="checkbox"/> IP Camera	1	2	3	4	5	6	7	8	9	10	11	12	13	14	15	16
	17	18	19	20	21	22										

You can enable or disable channel recording by ticking or unticking the **Record Channel** check box.

When Record Channel is enabled you can choose all analogue or all IP cameras by selecting the **Analogue Channels** and **IP Camera** check boxes. Finally you can select any combination of analogue and IP cameras by highlighting the individual channels.

### Post Recording

The Post Recording time determines how long the recorder continues to capture footage for after the input trigger ends. This can be used to ensure you capture an entire event as you may still require footage after a brief alarm trigger.

You can set the post recording time between 30 seconds and 5 minutes using the **Post Recording** drop down list.

## On Screen Notification

When **Show Message** is turned on an icon of a yellow bell will appear in the top right corner when a channel is recording as the result of an alarm trigger. You can turn this feature on or off using the **Show Message** check box.

## Email Notifications

You can set the recorder to include alarm triggers in its email reports by selecting the Send Email check box. For more information on setting up emails accounts and email schedules see the [Email](#)<sup>(252)</sup> section in the Network Menu.

## FTP Uploads

You have the option to automatically upload snapshots or video footage to an FTP server when an alarm is triggered. The snapshots and video footage will be from each channel set to record for the effected alarm input. You will first need to configure the FTP server connection as described in the [FTP](#)<sup>(257)</sup> section. Once this is set up you can simply select the **FTP Picture Upload** and/or the **FTP Video Upload** check boxes.

## Cloud Uploads

You have the option to automatically upload snapshots or video footage to a cloud storage account when an alarm is triggered. The snapshots and video footage will be from each channel set to record for the effected alarm input. This can be Dropbox or Google Drive. You will first need to configure your cloud storage account as described in the [Cloud](#)<sup>(270)</sup> section. When you have set up your cloud storage account you can select the **Picture To Cloud** and/or the **Video To Cloud** check boxes.

## Open Full Screen On Alarm Trigger

By ticking the **Full Screen** check box you can tell the recorder to open a camera's image full screen when an alarm is triggered. When enabled the recorder will display the camera you have set to record for the effected alarm input. This is useful in control room settings where the cameras are monitored.

This feature will only work when you have a single camera set to record as it obviously isn't possible to open multiple cameras full screen at the same time.

## Copying Alarm Input Settings

You can copy alarm input settings from one camera to another by clicking the **Copy** button as explained in the [Parameter Copy](#)<sup>(319)</sup> section.

## Defaulting Settings

To restore settings back to the factory default you can click the **Default** button.

### Saving Changes

When you are happy with the current settings click the **Apply** button. If you exit the window without saving any changes will be lost.

## 11.3 Alarm Menu - Smart

In the **Smart** sub-menu you can set what action the recorder takes when there is a Smart trigger from one of the connected Zip AI cameras. These are also the same options you will see if you click the **Alarm** button when setting up Smart settings in the Video menu.

The Smart alarm options are the same in each of the Smart alarm sub-menus; PID, LCD, SOD, PD, FD, CC, Sound Detection and Lens Covered.

The settings available will differ depending on recorder, camera type and camera model.

Camera	Buzzer	Alarm Out	Latch Time	Record	Post Recording	Show Message	Send Email	FTP Picture Upload	FTP Video Upload	Picture to Cloud	Video to Cloud	Full Screen
IP Cam1	Disable		10 s	ON	30 s	<input checked="" type="checkbox"/>	<input checked="" type="checkbox"/>	<input checked="" type="checkbox"/>	<input type="checkbox"/>	<input checked="" type="checkbox"/>	<input type="checkbox"/>	<input type="checkbox"/>
IP Cam2	Disable		10 s	ON	30 s	<input checked="" type="checkbox"/>	<input checked="" type="checkbox"/>	<input checked="" type="checkbox"/>	<input type="checkbox"/>	<input checked="" type="checkbox"/>	<input type="checkbox"/>	<input type="checkbox"/>
IP Cam3	Disable		10 s	ON	30 s	<input checked="" type="checkbox"/>	<input checked="" type="checkbox"/>	<input checked="" type="checkbox"/>	<input type="checkbox"/>	<input checked="" type="checkbox"/>	<input type="checkbox"/>	<input type="checkbox"/>
IP Cam4	Disable		10 s	ON	30 s	<input checked="" type="checkbox"/>	<input checked="" type="checkbox"/>	<input checked="" type="checkbox"/>	<input type="checkbox"/>	<input checked="" type="checkbox"/>	<input type="checkbox"/>	<input type="checkbox"/>

Smart Copy Default Apply

### Camera

Lists all channels on the recorder.

### Audio Warning

The recorder can be set to produce a loud beeping sound when there is a trigger on the selected camera. From the **Buzzer** drop down list you can choose the length of time the recorder will sound the audio alarm for. You can also select **Disable** if you don't want the recorder to sound a warning when triggered.

### Trigger An Alarm Output

You can tell the recorder to trigger alarm outputs to activate a 3rd party device such as a floodlight upon a trigger from the selected camera. Clicking the **Cog** icon in the **Alarm Out** column will open the Alarm Output window where you can dictate which alarm outputs will be triggered. These can be the recorder's own local alarm outputs, the alarm outputs of connected IP cameras or you can simply select All.

All  
 Local->1  
 IP Cam1->1     IP Cam2->1     IP Cam3->1  
 IP Cam4->1

### Latch Time

The Latch Time is the amount of time the alarm output remains active. You can set the Latch Time up to a maximum of 60 seconds using the drop down list

### Record Video On Smart Trigger

The recorder can be set to capture footage from a single or multiple channels when there is a trigger. Typically if there is a trigger on camera 1 you would want to record channel 1. This feature however allows you trigger recording on nearby cameras at the same time or all entrances for example.

To set which channels are recorded click the **Cog** icon in the **Record** column to display the Record Channel window.

**Record Channel**  
 Analogue Channels    

1	2	3	4	5	6	7	8	9	10	11	12	13	14	15	16
---	---	---	---	---	---	---	---	---	----	----	----	----	----	----	----

  
 IP Camera    

1	2	3	4	5	6	7	8	9	10	11	12	13	14	15	16
17	18	19	20	21	22										

You can enable or disable channel recording by ticking or unticking the **Record Channel** check box.

You can then choose all analogue or all IP cameras by selecting the **Analogue Channels** and **IP Camera** check boxes. Finally you can select any combination of analogue and IP cameras by highlighting the individual channels.

## Post Recording

The Post Recording time determines how long the recorder continues to capture footage for after the last movement was detected. This gives you a bit of leeway in-case the object which triggered the motion detection moves again or returns.

You can set the post recording time between 30 seconds and 5 minutes using the **Post Recording** drop down list.

## On Screen Notification

When **Show Message** is turned on an icon of a red bell with an S inside it will appear in the top right corner of the screen whenever there is a Smart trigger. You can turn this feature on or off using the **Show Message** check box.

## Email Notifications

You can set the recorder to include Smart triggers in its email reports by selecting the Send Email check box. For more information on setting up emails accounts and email schedules see the [Email](#)<sup>(252)</sup> section in the Network Menu.

## FTP Uploads

You have the option to automatically upload snapshots of Smart triggers or video footage covering the incident to an FTP server. You will first need to configure the FTP server connection as described in the [FTP](#)<sup>(257)</sup> section. Once this is set up you can simply select the **FTP Picture Upload** and/or the **FTP Video Upload** check boxes.

## Cloud Uploads

You can also automatically upload snapshots or video footage of Smart triggers to a cloud storage account. This can be Dropbox or Google Drive. You will first need to configure your cloud storage account as described in the [Cloud](#)<sup>(270)</sup> section. When you have set up your cloud storage account you can select the **Picture To Cloud** and/or the **Video To Cloud** check boxes.

## Open Full Screen On Smart Trigger

By ticking the **Full Screen** check box you can tell the recorder to open the camera's image full screen when there is a trigger. This is useful in control room settings where the cameras are monitored.

## Configuring Smart Detection

Clicking the **Smart** button in any of the Smart alarm sub-menus will display a setup screen where you can configure that smart detection feature. For more information on configuring Smart detection see the [Video Menu - Smart](#)<sup>(163)</sup> section.

- [PID](#)<sup>(163)</sup> (Perimeter Intrusion Detection)
- [LCD](#)<sup>(167)</sup> (Line Crossing Detection)
- [SOD](#)<sup>(171)</sup> (Stationary Object Detection)

- [PD](#)<sup>(175)</sup> (Pedestrian Detection)
- [FD](#)<sup>(180)</sup> (Face Detection)
- [CC](#)<sup>(186)</sup> (Cross Counting)
- [Sound Detection](#)<sup>(190)</sup>
- [Lens Covered](#)<sup>(193)</sup>
- [Schedule](#)<sup>(195)</sup>
- [Intelligent Analysis](#)<sup>(197)</sup>

### Copying Smart Alarm Settings

You can copy Smart alarm settings from one camera to another by clicking the **Copy** button as explained in the [Parameter Copy](#)<sup>(319)</sup> section.

### Defaulting Settings

To restore settings back to the factory default you can click the **Default** button.

### Saving Changes

When you are happy with the current settings click the **Apply** button. If you exit the window without saving any changes will be lost.

## 11.4 Alarm Menu - PTZ Linkage

The **PTZ Linkage** sub-menu is a great way enhance your security system. It allows you to tell PTZ cameras to move to a specific location when an alarm input is triggered or motion detected by another camera. This is achieved by activating one of the PTZ's preset locations.

This could be used to tell one PTZ to look at the main gate and a second PTZ to look at the rear entrance when a PIR detects movement for example.

The settings available will differ depending on recorder, camera type and camera model.

Camera	Switch	Motion	Alarm	PTZ1	PTZ2	PTZ3	PTZ4
Cam1	<input type="checkbox"/>	<input checked="" type="checkbox"/>		OFF	OFF	OFF	OFF
Cam2	<input type="checkbox"/>	<input checked="" type="checkbox"/>		OFF	OFF	OFF	OFF
Cam3	<input type="checkbox"/>	<input checked="" type="checkbox"/>		OFF	OFF	OFF	OFF
Cam4	<input type="checkbox"/>	<input checked="" type="checkbox"/>		OFF	OFF	OFF	OFF
Cam5	<input type="checkbox"/>	<input checked="" type="checkbox"/>		OFF	OFF	OFF	OFF
Cam6	<input type="checkbox"/>	<input checked="" type="checkbox"/>		OFF	OFF	OFF	OFF
Cam7	<input type="checkbox"/>	<input checked="" type="checkbox"/>		OFF	OFF	OFF	OFF
Cam8	<input type="checkbox"/>	<input checked="" type="checkbox"/>		OFF	OFF	OFF	OFF
Cam9	<input type="checkbox"/>	<input checked="" type="checkbox"/>		OFF	OFF	OFF	OFF
Cam10	<input type="checkbox"/>	<input checked="" type="checkbox"/>		OFF	OFF	OFF	OFF
Cam11	<input type="checkbox"/>	<input checked="" type="checkbox"/>		OFF	OFF	OFF	OFF
Cam12	<input type="checkbox"/>	<input checked="" type="checkbox"/>		OFF	OFF	OFF	OFF
Cam13	<input type="checkbox"/>	<input checked="" type="checkbox"/>		OFF	OFF	OFF	OFF
Cam14	<input type="checkbox"/>	<input checked="" type="checkbox"/>		OFF	OFF	OFF	OFF
Cam15	<input type="checkbox"/>	<input checked="" type="checkbox"/>		OFF	OFF	OFF	OFF
Cam16	<input type="checkbox"/>	<input checked="" type="checkbox"/>		OFF	OFF	OFF	OFF
IP Cam1	<input type="checkbox"/>	<input checked="" type="checkbox"/>		OFF	OFF	OFF	OFF
IP Cam2	<input type="checkbox"/>	<input checked="" type="checkbox"/>		OFF	OFF	OFF	OFF

### Setting Up PTZ Linkage

#### 1. Selecting Your Camera

The first thing you need to do is choose which camera you want to set up PTZ linkage for. The **Camera** column shows all analogue and IP cameras connected to the recorder. Once you have found the camera you want to configure, tick the **Switch** check box to enable PTZ linkage for that camera.

#### 2. Using Motion Detection To Control PTZ Cameras

You can use the motion detection of any analogue or IP camera to control up to 4 PTZ cameras.

If you want to use a camera's motion detection to trigger PTZ movement you need to tick the **Motion** check box. Likewise, if you don't want to use a camera's motion detection only its alarm inputs, you can un-tick the **Motion** check box.

For more information on setting up motion detection see the [Video Menu - Motion](#) <sup>159</sup> section.



### 3. Using Alarm Inputs To Control PTZ Cameras

Alarm input triggers can also be used to control PTZ cameras. These can be the alarm inputs on the recorder itself or the alarm inputs on connected IP cameras.

The recorder's alarm inputs are paired to the corresponding camera inputs. So alarm input 1 is paired to camera 1 and so on.

To choose which alarm inputs to use as a PTZ trigger click the **Cog** icon in the **Alarm** column. This will display all available alarm inputs for the selected camera.



You can enable or disable each alarm input trigger by ticking or unticking the check box.

### 4. Selecting Which PTZ Cameras And Presets To Trigger

Once you have set up how the PTZs will be triggered you can choose which PTZs and which presets to activate. You can select up to 4 PTZs for each camera and choose a preset location for each one.

To configure a PTZ camera click the **Cog** icon in the **PTZ1**, **PTZ2**, **PTZ3** or **PTZ4** column.



Here you can tick or un-tick the check box to enable or disable the PTZ activation. You then can select which PTZ you want to activate from the first drop-down list.

The second drop-down list will then be populated with all of the previously saved presets for the selected PTZ camera. You can then select which preset location you want the PTZ camera to look at when activated.

To see how to set up PTZ presets see the [Live View Toolbar - PTZ Controls](#)<sup>40</sup> section.

### Copying PTZ Linkage Settings

You can copy PTZ linkage settings from one camera to another by clicking the **Copy** button as explained in the [Parameter Copy](#)<sup>319</sup> section.

### Defaulting Settings

To restore settings back to the factory default you can click the **Default** button.



### **Saving Changes**

When you are happy with the current settings click the **Apply** button. If you exit the window without saving any changes will be lost.

## 11.5 Alarm Menu - Exception

In the Exception sub-menu you can decide how the recorder alerts you when an error occurs or maintenance is required.

The settings available may differ depending on the model of recorder.

Event Type	Switch	Buzzer	Alarm Out	Latch Time	Show Message	Send Email
No Space on Disk	<input checked="" type="checkbox"/>	Disable		10 s	<input checked="" type="checkbox"/>	<input checked="" type="checkbox"/>
Disk Error	<input checked="" type="checkbox"/>	Disable		10 s	<input checked="" type="checkbox"/>	<input checked="" type="checkbox"/>
Video Loss	<input checked="" type="checkbox"/>	Disable		10 s	<input checked="" type="checkbox"/>	<input checked="" type="checkbox"/>

Default Apply

### Event Type

There are various events you can set up alerts for as listed **Event Type** column.

- **No Space on Disk** - Alerts will be triggered when a hard drive is full and automatic overwriting has not been enabled.
- **Disk Error** - Alerts will be triggered when the recorder can not write to a hard drive. This could be a failed drive or a loose cable for example.
- **Video Loss** - Alerts will be triggered when the recorder loses connection to a camera.

### Enabling And Disabling Alerts

You can turn alerts On or Off for each event type by ticking or unticking the check box in the **Switch** column.

### Audio Warning

The recorder can be set to produce a loud beeping sound when an event occurs. From the **Buzzer** drop down list you can choose the length of time the recorder will sound the audio alarm for. You can also select **Disable** if you don't want the recorder to sound a warning when triggered.

### Trigger An Alarm Output

You can tell the recorder to trigger alarm outputs to activate a 3rd party device such as a floodlight when an exception event occurs. Clicking the **Cog** icon in the **Alarm Out** column will open the Alarm Output window where you can dictate which alarm outputs will be triggered. These can be the recorder's own local alarm outputs, the alarm outputs of connected IP cameras or you can simply select All.

<input type="checkbox"/> All		
<input type="checkbox"/> Local->1		
<input type="checkbox"/> IP Cam1->1	<input type="checkbox"/> IP Cam2->1	<input type="checkbox"/> IP Cam3->1
<input type="checkbox"/> IP Cam4->1		

### Latch Time

The Latch Time is the amount of time the alarm output remains active. You can set the Latch Time up to a maximum of 60 seconds using the drop down list

### On Screen Notification

When **Show Message** is turned on you will get a visual notification during live view to indicate that an exception event has occurred. You can turn this feature on or off using the **Show Message** check box.

Each event type will display a different notification as described below:

#### No Space on Disk



This icon will be displayed at the bottom of the screen during live view to show that all available hard drives are full and there is no room left for recording.

#### Disk Error

No.	Serial No.	Model	Firmware	State	Free/Total	Free
1*	W1E6SFY1	ST2000DM001-1CH164	CC27	HDD ERROR	0M/1863GB	0s
2*	W1E6SFY2	ST2000DM001-1CH164	CC27	FULL	0M/1863GB	0s

Configuration



An icon similar to the one shown above will be displayed at the bottom of the screen during live view to show that there is an issue preventing the recorder from writing to a hard drive. The icon shown will depend what issue has caused the error. For more information on disk errors see the [Exception - Disk Error](#)<sup>(237)</sup> section.

### Video Loss



An NCD (No Camera Detected) graphic will be displayed as a channel's image if the recorder can't detect a camera.

### Email Notifications

You can set the recorder to include exceptions in its email reports by selecting the Send Email check box. For more information on setting up emails accounts and email schedules see the [Email](#)<sup>(252)</sup> section in the Network Menu.

### Defaulting Settings

To restore settings back to the factory default you can click the **De fault** button.

### **Saving Changes**

When you are happy with the current settings click the **Apply** button. If you exit the window without saving any changes will be lost.

### 11.5.1 Alarm Menu - Exception - Disk Error

When the recorder can not write to a disk a hard driver error icon will appear during live view if the Disk Error exception is enabled in the [Exceptions](#)<sup>(233)</sup> menu.

The icon and message will differ depending on the error as explained below. For more information on the recorder's hard drives see the the [Storage Menu](#)<sup>(265)</sup> section.

#### Hard Drive Error

A hard drive error usually occurs when a hard drive fails so the recorder can see the drive but can no longer write to it. When this happens the following window will be displayed showing which drive has failed.

No.	Serial No.	Model	Firmware	State	Free/Total	Free
1*	W1E6SFY1	ST2000DM001-1CH164	CC27	HDD ERROR	0M/1863GB	0s
2*	W1E6SFY2	ST2000DM001-1CH164	CC27	FULL	0M/1863GB	0s

Configuration



Clicking the **Configuration** button will take you to the [Storage Menu](#)<sup>(265)</sup> section.

#### Unformatted Hard Drive

All hard drives must be formatted before they can be used by the recorder. When the recorder detects an unformatted hard drive the following warning will be displayed.

By default only the unformatted hard drive icon will be displayed. Clicking the icon will open the information window where you can see which drive needs formatting.

No.	Serial No.	Model	Firmware	State	Free/Total	Free
1*	W1E6SFY1	ST2000DM001-1CH164	CC27	Unformatted	0M/1863GB	0s
2*	W1E6SFY2	ST2000DM001-1CH164	CC27	FULL	0M/1863GB	0s



Clicking the **Configuration** button will take you to the [Storage Menu](#)<sup>(265)</sup> section where you can format the drive.

### No Hard Drive Detected

If the recorder can not find any hard drives the following message will be displayed. Once you click the **OK** button the window will close but the icon will remain on screen.

If you don't intend on recording footage you could disable the Disk Error event type in the [Exceptions Menu](#)<sup>(233)</sup> so that the error message is not displayed.





## 11.6 Alarm Menu - Alarm Schedule

From the Alarm Schedule sub-menu you can create a unique timetable to tell the recorder when alarm triggered events should be active for each camera.

For example, you may have motion detection configured on camera 1 so that when movement is detected one of the recorders alarm outputs is triggered and a snapshot is uploaded to an FTP server. With an alarm schedule this could be set to only happen at night, outside of business hours, when no staff members are on site.

If you were to schedule alarm outputs for camera 1 to be active between 7pm and 7am, any events where camera 1 would trigger an alarm output will only do so during these hours.

Camera: Cam1

Alarm Out     Push     FTP Upload

Cloud Upload     Buzzer

0 2 4 6 8 10 12 14 16 18 20 22

SUN  
MON  
TUE  
WED  
THU  
FRI  
SAT

Copy Default Apply

### Camera

Select the camera you want to create an alarm schedule for from the **Camera** drop down list..

### Trigger Event

For maximum flexibility you can create individual alarm schedules for 5 different alarm triggered events listed below:

- **Alarm Out** - any alarm outputs the camera is set to trigger.
- **Push** - any time an event should send a push notification to the Zip mobile app.
- **FTP Upload** - image or video uploads to an FTP server for the chosen camera.
- **Cloud Upload** - image or video uploads to an cloud storage account for the chosen camera.
- **Buzzer** - any time the recorder should produce a loud beeping alert.

To select the trigger event you want to create a schedule for simply click the radio button trigger event type.

### Editing A Schedule

By default each trigger event type is scheduled to be active 24 hours a day, 7 days a week.

### Removing A Schedule

To remove a schedule follow these simple steps:

1. Click the radio button for the trigger event type you want to remove.
2. Click and drag over the time period you want to remove the scheduled trigger event from. You can drag over multiple days at once if needed.

### Creating A Schedule

To create a schedule or add to an existing schedule follow these simple steps:

1. Click the coloured radio button for the trigger event type you want to create the schedule for.
2. Click and drag over the time period you want to schedule the trigger event to be active. You can drag over multiple days at once if needed.

### Copying Alarm Schedules From One Camera To Another

Rather than re-creating the same schedule for each camera you can copy schedules from one camera to another by clicking the **Copy** button. For more information on copying schedules see the [Parameter Copy](#)<sup>(319)</sup> section.

### Defaulting Settings

You can restore settings back to their default value by clicking the **Default** button.

### Saving Changes

Once you are happy with your schedules click the **Apply** button to save them. Alternatively you can right click with the mouse to exit the Record Schedule screen without saving changes.

## Network Menu

In the Network menu you can configure the recorder for access over a network or over the internet. Here you can define network settings, DDNS accounts, email settings, FTP settings and more.

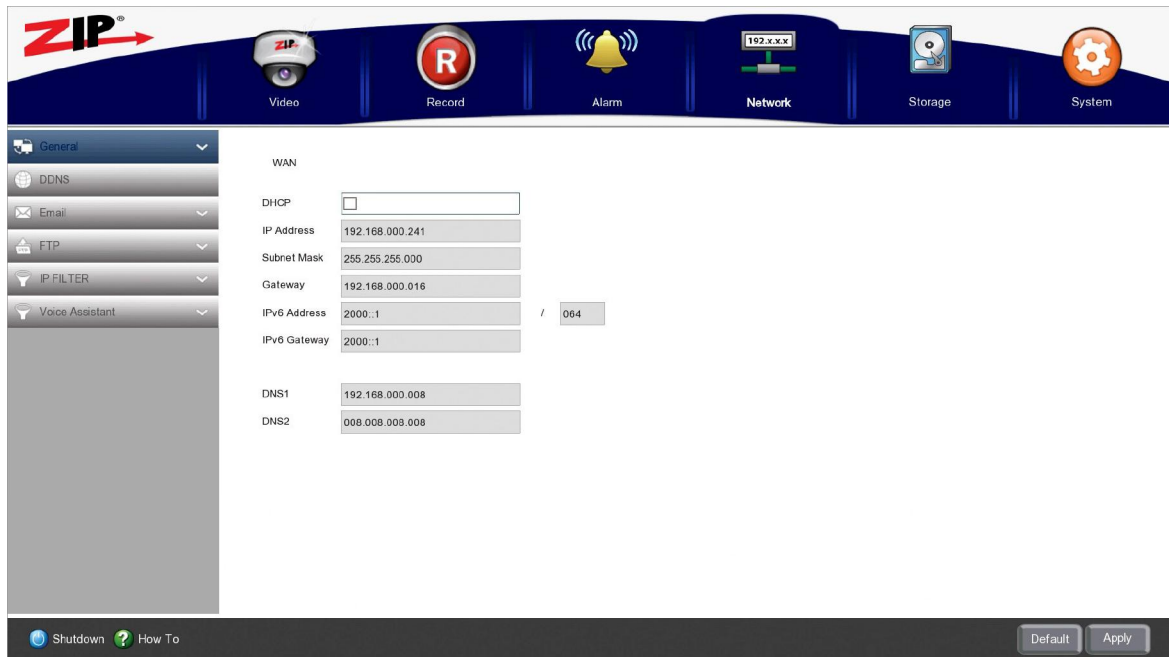

From the Network menu you can access the following sub-menus and features.

### General

In the [General sub-menu](#) <sup>(243)</sup> you can configure the recorder's network settings, PPPoE and port forwarding.

### DDNS

The [DDNS sub-menu](#) <sup>(250)</sup> allows you connect the recorder to a DDNS service.

### Email

The [Email sub-menu](#) <sup>(252)</sup> lets you enter an email account to receive email notifications and set up an email notification schedule.

### FTP

In the [FTP sub-menu](#) <sup>(257)</sup> you can link the recorder to an FTP server for automatic uploads and create an upload schedule.

## IP Filter

The [IP Filter sub-menu](#)<sup>(262)</sup> allows you to restrict access so only specific IP addresses or network segments can connect to the recorder.

## Voice Assistant

In the [Voice Assistant sub-menu](#)<sup>(264)</sup> you link your recorder to a Google or Amazon account for use with a smart home device.

## 12.1 Network Menu - General

In the **General** sub-menu you can set up the recorders network settings. Setting your recorder up on a network will allow you to remotely monitor the recorder from a PC, tablet or mobile phone once either [P2P setup](#)<sup>(58)</sup> or [port forwarding](#)<sup>(247)</sup> has been configured. You can also connect to IP cameras on the same network, send email notifications and schedule automatic FTP uploads.

Your recorder should be plugged in to a network or router before you make changes in this section.

WAN

DHCP

IP Address

Subnet Mask

Gateway

IPv6 Address  /

IPv6 Gateway

DNS1

DNS2

### Local Connection Settings

Selecting **DHCP** the easiest way to complete this section as it will allow the network to automatically set the IP address, subnet mask, gateway, IPv6 address and IPv6 gateway.

Once the network parameters have been set, deselect DHCP to lock in the credentials and to prevent the network re-assigning them in the future. These credentials are what the software and apps use when looking for the recorder over the internet so if they change the software wont be able to find the recorder.

If you know what credentials you wish to use, such as a static IP address, you can de-select DHCP and enter them manually.

**Note:** If your IP Address, Subnet Mask and Gateway show as 000.000.000.000 this means that your recorder is not connected to the router.

### DNS Settings

Selecting **DHCP** will automatically assign the DNS addresses from the router. This is usually the service provider's DNS address. DNS2 is automatically assigned as 8.8.8.8 which is Google's primary DNS address.

The default DNS addresses are usually adequate for most people but if you wish to set the DNS addresses manually you can de-select DHCP to do so.

### Defaulting Settings

To restore settings back to the factory default you can click the **Default** button.

### Saving Changes

When you are happy with the current settings click the **Apply** button. If you exit the window without saving any changes will be lost.

## 12.1.1 Network Menu - General - PPPoE

The PPPoE sub-menu (Peer-to-Peer Protocol over Ethernet) allows you to set up a direct connection for the recorder to your internet provider. This direct connection can only be to a single device so in most cases the direct link from the provider to your home or business is connected to a router. Multiple devices can then connect to the router for internet access.

Usually you will not use PPPoE as you will just connect the recorder to your router or a switch so you do not need to make changes here. However, if you have a dedicated line for the recorder you can bypass the router and connect direct to you service provider using the the username and password they have assigned to you.

The screenshot shows a web-based configuration interface for PPPoE. It features the following elements:

- Enable PPPoE:** A checkbox that is currently unchecked.
- User:** A text input field.
- Password:** A text input field with a "Show Password" checkbox to its right.
- IP Address:** A text input field containing "192.168.000.241".
- Subnet Mask:** A text input field containing "255.255.255.000".
- Gateway:** A text input field containing "192.168.000.016".
- DNS1:** A text input field containing "192.168.000.008".
- DNS2:** A text input field containing "008.008.008.008".
- Buttons:** "Default" and "Apply" buttons located at the bottom right of the form.

### Enabling PPPoE

If you are using a PPPoE connection for the recorder you will need to tick the **Enable PPPoE** check box.

### Username And Password

Once you have enabled PPPoE you can enter the username and password provided by your service provider for the connection.

### Network Settings

The recorder's network settings are also displayed so that you can check that everything is as it should be. If you need to make changes to the recorder's network settings this can be done in the [Network Menu - General](#) <sup>(243)</sup> sub-menu.

### Defaulting Settings

To restore settings back to the factory default you can click the **Default** button.

### **Saving Changes**

When you are happy with the current settings click the **Apply** button. If you exit the window without saving any changes will be lost.



### 12.1.2 Network Menu - General - Port Configuration

In the Port Configuration sub-menu you can configure port forwarding to tell your router which ports to use for remote monitoring over the internet.

The easiest way to set up a recorder for remote monitoring is to use the P2P feature where you scan a QR using the mobile app and the recorder's settings are configured for you. You can find out more about this in the [P2P section](#)<sup>(58)</sup>.

When setting up your recorder using P2P you don't need to worry about port forwarding as everything is done automatically. If you are unable to set up remote monitoring via P2P you will need to configure port forwarding as explained below and [DDNS](#)<sup>(250)</sup>.

You only need to set up port forwarding and DDNS if you intend to monitor your CCTV using the Zip Vision mobile app, PC client or IE web client.

	Service	Protocol	Internal Port	External Port	UPnP Status	Mapping Strategy	UPnP
1	Web	TCP	00080	00080	Inactive	Auto	<input type="checkbox"/>
2	Client	TCP	08240	08240	Inactive	Auto	<input type="checkbox"/>
3	RTSP	TCP	01240	01240	Inactive	Auto	<input type="checkbox"/>
4	Https	TCP	00544	00443	Inactive	Auto	<input type="checkbox"/>

Instruction:

Analogue Channel: rtsp://IP:Port/chA/B

IP Channel: rtsp://IP:Port/ipA/B

A:01(ch1),02(ch2)...

B:0(main stream),1(sub stream)

External IP

P2P Switch

Default Apply

When setting up port forwarding there are 4 ports that you need to specify; Web, Client, RTSP and Https.

Once you have set up port forwarding you can test everything is working OK at [www.zipdvr.com/connect](http://www.zipdvr.com/connect)

#### Setting Up Port Forwarding - UPnP

The easiest way to configure port forwarding is using UPnP automatic port forwarding (Universal Plug and Play). If your router supports UPnP you can set the ports in the recorder which will then communicate with your router for you.

To set up port forwarding using UPnP just follow the steps below:

1. Tick the **UPnP** check box for each of the 4 ports to enable it.
2. Set the **Mapping Strategy** drop down list for each of the 4 ports to **Manual**.
3. Set the **External Ports** as followed:
  - **Web (HTTP)** = 00080
  - **Client** = 08240
  - **RTSP** = 01240
  - **HTTPS** = 00544

*Note: The Mapping Strategy can be set to Auto and then the router will automatically assign External Ports. However, this can cause problems as the router may assign different ports in the future so streaming links will be broken as they will still try to connect using the old settings.*

### Setting Up Port Forwarding - Web Interface

If your router does not support UPnP you will need to set the ports manually in the router itself. This can be done by accessing your router's web interface via a browser.

This process will be slightly different for each router. To see how this is done you may need to look online for information regarding your router or contact your internet service provider if the router was supplied by them.

When setting the ports manually they should be set as listed below:

- **Web (HTTP)** = 00080
- **Client** = 08240
- **RTSP** = 01240
- **HTTPS** = 00544

### Setting Up Port Forwarding For Multiple Recorders

If you have multiple recorders connected to the same router you will need to set up port forwarding for each recorder separately and they can not share ports. To keep things easy we recommend just increasing the port number by 1 each time. For example:

- **Recorder 1** - Web = 00080 / Client = 08240 / RTSP = 01240 / HTTPS = 00544
- **Recorder 2** - Web = 00081 / Client = 08241 / RTSP = 01241 / HTTPS = 00545
- **Recorder 3** - Web = 00082 / Client = 08242 / RTSP = 01242 / HTTPS = 00546

### RTSP Streaming Links

The "**Instructions**" show how you would input an RTSP stream link if you wanted to view a camera from your recorder on another device.

When connecting to a channel on your recorder you would enter the RTSP stream link as followed:

rtsp://	Recorder's IP Address	:	Recorder's RTSP Port	/	Channel Type	Channel Number	Stream Quality
	This can be found in Network Menu - General		If you are streaming from a recorder on the same network use the Internal port otherwise use the External port.		Analogue = ch IP = ip	01, 02, 03 etc	Mainstream = 0 Substream = 1

For example if you wanted to view the mainstream of an analogue camera on channel 1, from a recorder with an IP address of 192.268.0.1 and with the RTSP port set as 01240 it would look like this;

```
rtsp://192.168.0.1:01240/ch010
```

If you wanted to view the substream of IP channel 3, from a recorder with an IP address of 192.268.0.1 and with the RTSP port set as 01240 it would look like this;

```
rtsp://192.168.0.1:01240/ip031
```

### External IP Address

The **External IP** address can not be set manually as this is not something you need to set. When the ports set UPnP and auto mapping the external IP address will be allocated automatically.

### Enabling And Disabling P2P ID

You can enable and disable P2P ID by ticking or unticking the **P2P Switch** check box.

You may want to do this once you have networked recorder and set up remote viewing to prevent others from gaining easy access to your recorder.

### Defaulting Settings

To restore settings back to the factory default you can click the **Default** button.

### Saving Changes

When you are happy with the current settings click the **Apply** button. If you exit the window without saving any changes will be lost.

## 12.2 Network Menu - DDNS

If you do not have a static IP address for your router then your routers public IP address assigned by your internet service provider can change periodically. DDNS (Dynamic Domain Name System) is used so that your remote device can still access your recorder when the address changes. The recorder periodically updates the DDNS server with the routers public IP address and the software or mobile app gets the address from the server to connect to the recorder.

Every Zip recorder is supplied with a free, 3 year DDNS service for its user. This allows you to quickly set up the recorder for remote monitoring, without the added expense or hassle of setting up a static IP.

The easiest way to set up a recorder for remote monitoring is to use the P2P feature where you scan a QR using the mobile app and the recorder's settings are configured for you. You can find out more about this in the [P2P section](#)<sup>(58)</sup>.

When setting up your recorder using P2P you don't need to worry about DDNS as everything is done automatically. If you are unable to set up remote monitoring via P2P you will need to configure DDNS as explained below and [Port Forwarding](#)<sup>(247)</sup>.

You only need to set up port forwarding and DDNS if you intend to monitor your CCTV using the Zip Vision mobile app, PC client or IE web client.

DDNS

Server ZIP\_DDNS

Domain JPV00000.ippostcode.com

Email

Password

DDNS Status: Incorrect Parameters have been entered.

## Enabling DDNS

To configure DDNS follow these simple steps:

1. Tick the check box to enable **DDNS**.
2. Select **ZIP-DDNS** from the **Server** drop down list.
3. The **Domain** will be the recorder's serial number followed by .ippostcode.com e.g. JPV000000.ippostcode.com
4. In the **Email** field enter the email address you want the authentication password sent to. *(This may take a few minutes to come through)*
5. Enter the authentication password you received by email into the **Password** field.
6. Click the **Test** button to check everything is working.

## Remote Monitoring

With DDNS and Port Forwarding now set up you can connect to your recorder remotely using the Zip Vision PC client software, mobile app or in the Internet Explorer browser. Just enter the recorder's serial number followed by .ippostcode.com e.g. JPV000000.ippostcode.com.

To log on to the recorder you need to enter the same username and password as you would on the recorder itself.

## Monitoring Multiple Recorders Connected To The Same Router

If you intend to remotely monitor multiple recorders connected to the same router you only need to setup DDNS for 1 recorder. This is because the ippostcode.com address targets the router and not a specific recorder. You can then pinpoint the recorder you want to connect to using the unique Client Port. For more information on setting up port forwarding for multiple recorders see the [Port Configuration](#)<sup>(247)</sup> section.

## Defaulting Settings

To restore settings back to the factory default you can click the **De fault** button.

## Saving Changes

When you are happy with the current settings click the **Apply** button. If you exit the window without saving any changes will be lost.

## 12.3 Network Menu - Email

If you want to receive email notifications from the recorder you have to configure your email settings in the Email sub-menu.

It is also a good idea to configure your email settings as a fail safe as this allows you to send a new admin password if you ever forget the recorder's log on credentials.

Once you have set up email notifications you will need to create an [Email Schedule](#)<sup>255</sup> to tell the recorder when to send emails and what to include.

The screenshot shows the 'Email' configuration menu. It includes the following fields and options:

- Email:** A checked checkbox.
- Encryption:** A dropdown menu set to 'Auto'.
- SMTP Port:** A text field containing '00025'.
- SMTP Server:** An empty text field.
- Username:** An empty text field.
- Password:** An empty text field with a 'Show Password' checkbox to its right.
- Sender:** An empty text field.
- Receiver 1:** An empty text field with a 'Receive Password' checkbox to its right.
- Receiver 2:** An empty text field with a 'Receive Password' checkbox to its right.
- Receiver 3:** An empty text field with a 'Receive Password' checkbox to its right.
- Interval:** A dropdown menu set to '3 Min'.
- Test Email:** A button below the Interval dropdown.

At the bottom right of the form are two buttons: 'Default' and 'Apply'.

The email settings will differ depending on the domain of email address you want to send the notifications from. You may have to check online for the settings of the domain you intend to use.

[Tip 460](#)<sup>323</sup> shows you how to set up email notifications for a [Gmail](#)<sup>323</sup> or a [Yahoo](#)<sup>326</sup> email address.

### Enabling Email Notifications

You can enable or disable email notifications by ticking or unticking the **Email** check box.

### Encryption

This can usually be left as **Auto** but you can choose **TLS**, **SSL** or **Disable** encryption if required from the drop down list.

## SMTP Port

The default SMTP port is **25**. In most cases this should be OK but you may need to change this depending on the encryption type or SMTP server you are using.

## SMTP Server

The SMTP Server needs to match the domain of the email address you want to send the notification emails from. For example if you wanted to send notification emails from [alerts@yahoo.com](mailto:alerts@yahoo.com) you would need to use the Yahoo SMTP server.

## Username

The Username is the email address you want to send the email notifications from.

## Password

This needs to be the one time use authentication password for you email account.

You will need to go into the security settings of the email account you have set as the Username above. From there you can generate an app password. In the app list choose **Other**, enter a memorable name like "Zip Recorder" then click Generate. This will produce your one time use authentication password.

## Sender

This is the name which will appear in the From field on the email notifications. You could simply re-enter the email address you are sending the notifications from or enter something more recognisable like "Office Recorder".

## Receiver

You can enter up to 3 email addresses you want to send email notifications to.

## Password Recovery

A major benefit of having email settings configured is the ability to send a new admin password if you ever forget the recorder's log-on details.

By ticking or unticking the **Receive Password** check box you can decide which email addresses will receive the new admin password when it is sent.

## Interval

You can set how often the recorder sends email notifications from the **Interval** drop down list. The interval can be set from 1 minute up to 10 minutes.

The recorder will only send notification emails when there is something to report. Setting an interval allows you to limit how many emails you receive as notifications will be compiled and sent together.

### Test Email

Once you have entered all of your email settings you can send a test email to check everything is working correctly by clicking the **Test Email** button.

### Defaulting Settings

To restore settings back to the factory default you can click the **Default** button.

### Saving Changes

When you are happy with the current settings click the **Apply** button. If you exit the window without saving any changes will be lost.



### 12.3.1 Network Menu - Email - Email Schedule

From the Email Schedule sub-menu you can create a unique timetable to tell the recorder when to send email notifications. You can also choose which event type notifications are included. This could be when motion is detected, when an alarm is triggered, when there is an exception error on the recorder or when there is a smart detection trigger.

For an event to be included in email notifications they will need to have **Send Email** ticked in the [Alarm Menu](#)<sup>(218)</sup> and be active in the email schedule.

As an example you could create a schedule which notifies of recorder exception errors at any time and just smart detection triggers during busy business hours. It could then switch to motion detection or alarm triggers at night when nobody is around. This would prevent the recorder from sending a large number of emails during the day when there are lots of people around and alert you to any activity at night when the premises should be empty.

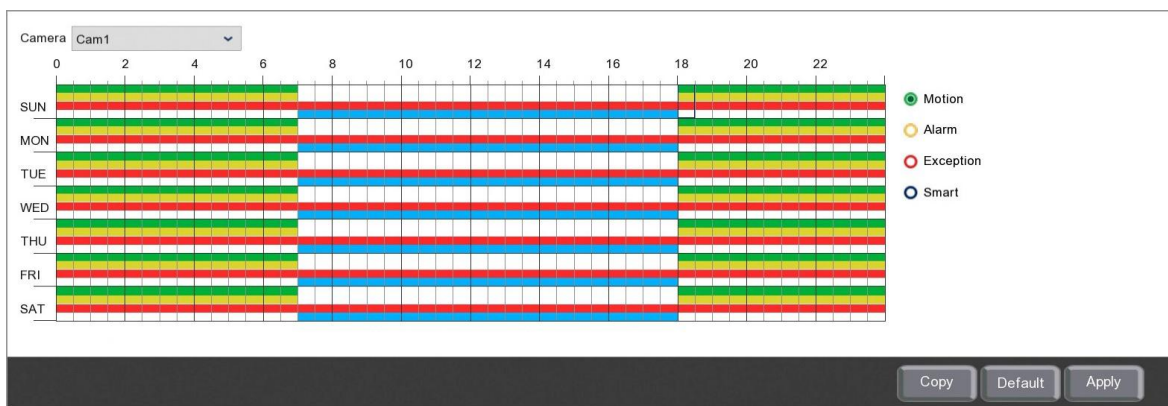

#### Camera

Select the camera you want to create the email schedule for from the **Camera** drop down list..

#### Event Types

For maximum flexibility you can create individual email schedules for **Motion** detection triggers, **Alarm** triggers, **Exception** errors and **Smart** detection triggers. To edit a schedule first click one of the coloured radio buttons to the right of the schedule to select the event type you want to configure.

#### Editing A Schedule

By default each of the 4 event types are scheduled to be active 24 hours a day, 7 days a week.

#### Removing A Schedule

To remove a schedule follow these simple steps:

1. Click the coloured radio button for the event type you want to remove.
2. Click and drag over the time period you want to remove the scheduled notifications from. You can drag over multiple days at once if needed.

### Creating A Schedule

To create a schedule or add to an existing schedule follow these simple steps:

1. Click the coloured radio button for the event type you want to create the schedule for.
2. Click and drag over the time period you want to schedule notifications for. You can drag over multiple days at once if needed.

### Copying Email Schedules From One Camera To Another

Rather than re-creating the same schedule for each camera you can copy schedules from one camera to another by clicking the **Copy** button. For more information on copying schedules see the [Parameter Copy](#)<sup>(319)</sup> section.

### Defaulting Settings

You can restore settings back to their default value by clicking the **Default** button.

### Saving Changes

Once you are happy with your schedules click the **Apply** button to save them. Alternatively you can right click with the mouse to exit the Record Schedule screen without saving changes.

## 12.4 Network Menu - FTP

The FTP sub-menu allows you to connect your recorder to an FTP server (File Transfer Protocol) so that you can schedule uploads of snapshots and video footage.

This handy feature gives you extra protection as it allows you to automatically save a copy of your CCTV footage. The FTP server could even be off-site for maximum security with your footage saved in 2 locations.

After configuring your FTP settings you will need to set up an [FTP Schedule](#)<sup>260</sup> so the recorder knows what to upload to your FTP server and when.

The screenshot shows the FTP configuration menu with the following fields and options:

- FTP Enable:
- Server IP:
- Port: 00021
- Username:
- Password:   Show Password
- Picture Resolution: 1280 x 720
- Picture Quality: Higher
- Video Stream Type: Substream
- Max Package Interval: 30 Min
- Directory Name:
- Upload Normal Video:  OFF
- Upload Alarm Video:

Buttons at the bottom: Default, Apply

### Enabling The FTP Upload Feature

You can enable or disable FTP uploads by ticking or unticking the **FTP Enable** check box.

### Server IP

This needs to be the IP address of the FTP server you are wanting to connect to.

### Port

This needs to be your FTP server port. By default this will be set to **21** as this standard port used for most FTP servers. You can usually leave this as it is.

## Username & Password

These are the credentials you normally use to log on to the FTP server. If you don't have log credentials you may need to ask whoever manages the FTP server for credentials you can use or to create a user account for you.

## Picture Resolution

You can choose the resolution of the snapshots the recorder will upload to the FTP server in the **Picture Resolution** drop down list.

## Picture Quality

You can choose the quality of the snapshot uploaded from the **Picture Quality** drop down list.

The Picture Quality works hand in hand with the Picture Resolution to produce the final image uploaded. If you were to set the Picture Resolution to 1080P (1920 x 1080) but the Picture Quality to Lowest, the end result would still be a 1080P sized image but the detail in the image would be poor.

## Video Stream Type

The **Video Stream Type** drop down list allows you to choose the quality of any video footage uploaded to the FTP server. You can choose between the Mainstream or Substream. The quality of the Mainstream and Substream recording is configured in the [Record - Encode](#)<sup>199</sup> section.

## Max Package Interval

You can set the amount of time between FTP uploads in the **Max Package Interval** drop down list. This can be set from 10 minutes up to 60 minutes. The recorder will only attempt to do an upload when there is new snapshots or video footage waiting to go.

On busy systems which capture a lot of footage you may want to do more frequent uploads so that you aren't uploading a large number of files at any one time. Likewise, on systems which don't capture much footage it may be worth setting the interval to 60 minutes so that files are uploaded in chunks rather than little bits here and there.

## Directory Name

This is the name of the folder on the FTP server where your snapshots and videos will be saved. You can enter the name of a folder that already exists and any uploads will be saved in there. Alternatively you can enter the name of a new folder that doesn't exist and this folder will then be created automatically.

## Upload Normal Video

By default only video footage from alarm triggered events will be uploaded to the FTP server. You can however upload any normal scheduled recordings as well.

To set which channels you want to upload the normal video recordings for click the **Cog** icon to display the Upload Normal Video window.

**Upload Normal Video**

Analogue Channels 

1	2	3	4	5	6	7	8	9	10	11	12	13	14	15	16
---	---	---	---	---	---	---	---	---	----	----	----	----	----	----	----

IP Camera 

1	2	3	4	5	6	7	8	9	10	11	12	13	14	15	16
17	18	19	20	21	22										

USB Wireless 

1	2														
---	---	--	--	--	--	--	--	--	--	--	--	--	--	--	--

You can enable or disable normal video uploads by ticking or unticking the **Upload Normal Video** check box.

You can then choose all analogue, all IP or all USB wireless cameras by selecting the **Analogue Channels**, **IP Camera** or **USB Wireless** check boxes. Finally you can select any combination of analogue, IP or USB wireless cameras by highlighting the individual channels.

### Upload Alarm Video

For alarm triggered snapshots and videos to be included in the FTP upload you need to enable FTP Picture Upload and FTP Video Upload for each channel required. This is done for each event type as shown in the [Alarm Menu - Motion](#)<sup>(220)</sup>, [Alarm Menu - I/O](#)<sup>(223)</sup> and [Alarm Menu - Smart](#)<sup>(226)</sup> sections.

You can quickly access the alarm menus by clicking the **Motion**, **I/O** and **Smart** buttons.

### Test FTP

Once you have entered all of you FTP server settings you can send a test the connection by clicking the **Test FTP** button.

### Defaulting Settings

To restore settings back to the factory default you can click the **Default** button.

### Saving Changes

When you are happy with the current settings click the **Apply** button. If you exit the window without saving any changes will be lost.

### 12.4.1 Network Menu - FTP Shchedule

In the FTP Schedule sub-menu you can create a unique timetable to tell the recorder when to upload snapshots and video footage to your FTP server. You can also choose which event types are included. This could be when snapshots or footage captured as the result of normal scheduled recording, a motion detection trigger, an alarm trigger or when there was a smart detection trigger.

For an event type to be included in FTP uploads they will need to have **FTP Picture Upload** or **FTP Video Upload** ticked in the [Alarm Menu](#)<sup>(218)</sup> for the channels required. For normal scheduled recordings to be included you will need to configure this in the [FTP sub-menu](#)<sup>(257)</sup>.

By default motion, alarm and smart detection triggered snapshots and videos are scheduled to upload 24 hours a, day 7 days a week. Normal scheduled recordings are not scheduled to be uploaded at all but this can all be amended as explained below.



#### Camera

Select the camera you want to create the FTP upload schedule for form the **Camera** drop down list..

#### Event Types

For maximum flexibility you can create individual FTP upload schedules for **Normal** scheduled, **Motion** detection triggered, **Alarm** triggered and **Smart** detection triggered snapshots and videos. To edit a schedule first click one of the coloured radio buttons to the right of the schedule to select the event type you want to configure.

#### Editing A Schedule

By default Motion, Alarm and Smart triggered snapshots and recordings are scheduled to be uploaded 24 hours a day, 7 days a week. Normal scheduled snapshots and recordings are not set to upload at all.

#### Removing A Schedule

To remove a schedule follow these simple steps:

1. Click the coloured radio button for the event type you want to remove.

2. Click and drag over the time period you want to remove the scheduled FTP uploads from. You can drag over multiple days at once if needed.

### Creating A Schedule

To create a schedule or add to an existing schedule follow these simple steps:

1. Click the coloured radio button for the event type you want to create the schedule for.
2. Click and drag over the time period you want to schedule FTP uploads for. You can drag over multiple days at once if needed.

### Copying FTP Upload Schedules From One Camera To Another

Rather than re-creating the same schedule for each camera you can copy schedules from one camera to another by clicking the **Copy** button. For more information on copying schedules see the [Parameter Copy](#)<sup>(319)</sup> section.

### Defaulting Settings

You can restore settings back to their default value by clicking the **Default** button.

### Saving Changes

Once you are happy with your schedules click the **Apply** button to save them. Alternatively you can right click with the mouse to exit the Record Schedule screen without saving changes.

## 12.5 Network Menu - IP Filter

With the **IP Filter** you can restrict access to the recorder to specific IP addresses making your system more secure by creating an Allow List. Alternatively you could just block troublesome IP addresses by creating a Block List.

Enable

Enable Allow List
  Enable Block List

Restricted Type: Allow List

Start Address:

End Address:

	No.	Start Address	End Address	Edit	Delete
<input type="checkbox"/>	1	192.168.0.100	192.168.0.100		
<input type="checkbox"/>	2	192.168.0.150	192.168.0.159		

### Enabling IP Filters

You can enable and disable the IP Filter by ticking or unticking the **Enable** check box.

Once the IP Filter is turned on you need to decide if you want to enable the **Allow List** or the **Block List** by highlighting the corresponding radio button.

The IP Filter can only be configured when enabled.

### Creating Lists

You can create 2 types of lists in the IP Filter menu, an **Allow List** which lets the specified IP addresses access the recorder or a **Block List** which prevents specified IP addresses accessing the recorder.

To create a list you will first need to select Allow List or Block List from the **Restricted Type** drop down list.

### Adding A Single IP Address

To add a single IP address to your selected list simply enter it into **Start Address** field and click the **Single Add** button.



## Adding An IP Address Range

To make things easier you can add a range of consecutive IP addresses rather than having to add each one in turn.

To add an IP address range to your selected list enter first IP address into **Start Address** field, the last IP address into the **End Address** field and click the **Network Segment Add** button.

## Editing An IP Address or Address Range

To edit an IP address or range follow these simple steps:

1. Select the Allow List or Block List from the **Restricted Type** drop down list.
2. Click the **Pencil Icon** in the **Edit** column on the IP address or range you want to amend to display the Edit window.
3. Amend the Start Address and End Address as required then click the **OK** button.

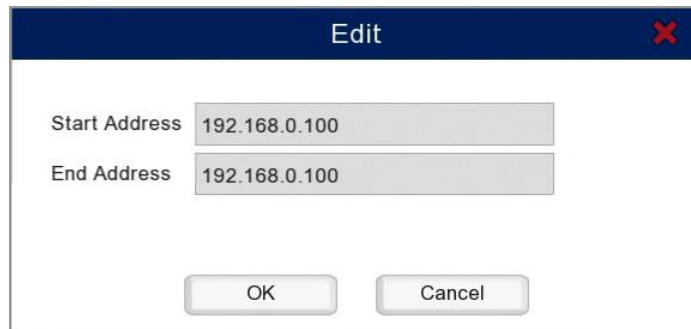

The screenshot shows a dialog box titled "Edit" with a close button (X) in the top right corner. Inside the dialog, there are two input fields. The first is labeled "Start Address" and contains the text "192.168.0.100". The second is labeled "End Address" and also contains "192.168.0.100". At the bottom of the dialog, there are two buttons: "OK" and "Cancel".

## Deleting An IP Address or Address Range

There are 2 ways you can delete a an IP address or range. When deleting a single record you can click the **Rubbish Bin** icon in the **Delete** column. When deleting multiple records you can tick the check box for each IP address or range you want to delete and then click the **Remove IP** button.

A warning message will be displayed asking if you want to delete the selected IP addresses. You can either click **OK** to delete the IP addresses or **Cancel** exit without deleting.

## Defaulting Settings

To restore settings back to the factory default you can click the **Default** button.

## Saving Changes

When you are happy with the current settings click the **Apply** button. If you exit the window without saving any changes will be lost.

## 12.6 Network Menu - Voice Assistant

*Please Note: Voice Assistant is only in the Beta stage at this time and is only available on certain models.*

## Storage Menu

In the Storage Menu you can manage your hard drives, run hard drive diagnostic checks and manage your cloud storage account.



From the Storage menu you can access the following sub-menus and features.

### Disk

In the [Disk sub-menu](#) <sup>(266)</sup> you can manage the hard drives inside the recorder.

### S.M.A.R.T

The [S.M.A.R.T sub-menu](#) <sup>(268)</sup> (Self-Monitoring, Analysis, and Reporting Technology) allows you to run detailed diagnostic checks on the recorder's hard drives.

### Cloud

The [Cloud sub-menu](#) <sup>(270)</sup> allows you to link the recorder to a cloud storage account for saving your videos and snapshots online.

## 13.1 Storage Menu - Disk

In the Disk sub-menu you can see key information for each hard drive, format hard drives and decide if and when footage is overwritten.

No.	Serial No.	Model	Firmware	State	Free/Total	Free/Total Time
<input type="checkbox"/> 1*	W1E6SFY1	ST2000DM001-1CH164	CC27	FULL	0M/1863GB	0s/353Hour
<input type="checkbox"/> 2*	W1E6SFY2	ST2000DM001-1CH164	CC27	FULL	0M/1863GB	0s/353Hour

Overwrite

### Hard Drive Information

#### Serial No.

This is the unique serial number for the hard drive.

#### Model

This is the manufacturers model number for the hard drive.

#### Firmware

Shows the firmware version the hard drive is running.

#### State

The State shows the current condition of the hard drive which may change over time. If ever there is a problem with the hard drive it will be displayed here in red.

#### Free/Total

Simply shows the amount of Free space available on the hard drive and the Total amount of usable space on the hard drive. The Total figure is the maximum amount of files that can be stored on the hard drive.

#### Free/Total Time

The Free time is the amount of time you can record for based on your current record settings and the free space available on the hard drive.

The Total time shows and estimate as to how many hours worth of footage the hard drive can store based on you current record settings and the size of the hard drive. Changing the record settings to a lower resolution, frame rate etc. will increase the Total recording time where as increasing your record settings will shorten it.

### Overwriting Old Footage

You can decide if and when old footage is overwritten from the **Overwrite** drop down list.

### Auto

When set to Auto the recorder will automatically start to overwrite old recordings with new ones when the hard drive is full. The recorder will always overwrite the oldest footage first.

### OFF

You can turn overwriting OFF so that when the hard drive is full the recorder stops saving footage. This is handy if you're required to archive footage for long periods, when the drive is full you can swap it out with a empty one.

You can configure **No Space On Disk** notifications in [Exception sub-menu](#)<sup>233</sup> so that the recorder will alert you when the drive is full.

### Specified Number Of Days

You also have the option to start overwriting old footage after a set amount of days. You can choose from 1 day up to 90 days. This is a great way to comply with **GDPR** as the recorder overwrites the oldest footage first so you can confidently state "We only store footage for X days".

### Formatting Hard Drives

There are a few occasions when you might want to format a hard drive. You may want to wipe all footage off a current hard drive or you may have a new hard drive. All new hard drives added to the recorder need formatting before they can be used.

To format a hard drive just tick the check box to select it and click the **Format HDD** button. You can format multiple drives at once to make things easier by selecting multiple hard drives and then clicking Format HDD.

### Defaulting Settings

To restore settings back to the factory default you can click the **Default** button.

### Saving Changes

When you are happy with the current settings click the **Apply** button. If you exit the window without saving any changes will be lost.

## 13.2 Storage Menu - Disk - S.M.A.R.T

S.M.A.R.T (Self-Monitoring, Analysis, and Reporting Technology) is a tool designed by IBM for checking the status of hard drives and predicting failures. Here we give a brief overview of performing S.M.A.R.T tests on a Zip recorder. If you are unfamiliar with S.M.A.R.T tests there's a wide range of information readily available online.

HDD ID:  Self-check Type:

Self-check State: Not detected

TEMP(°C): 34 Utility Time(d): 52

Whole Evaluation: PASSED

**S.M.A.R.T. Info:**

ID	Attribute Name	Status	Flags	Value	Worst	Threshold	Raw Value
0x1	Raw Read Error Rate	OK	f	115	99	6	91659312
0x3	Spin Up Time	OK	3	93	93	0	0
0x4	Start Stop Count	OK	32	100	100	20	257
0x5	Reallocated Sector Ct	OK	33	100	100	10	0
0x7	Seek Error Rate	OK	f	76	60	30	42167910
0x9	Power On Hours	OK	32	99	99	0	1262
0xa	Spin Retry Count	OK	13	100	100	97	0
0xc	Power Cycle Count	OK	32	100	100	20	210
0xb8	End-to-End Error	OK	32	100	100	99	0
0xbb	Reported Uncorrect	OK	32	100	100	0	0
0xbc	Command Timeout	OK	32	100	100	0	0
0xbd	High Fly Writes	OK	3a	1	1	0	99
0xb6	Airflow Temperature Cel	OK	22	66	60	45	34 (Min/Max: 18/34)

### Running a Test

To run a S.M.A.R.T test follow these steps:

1. Select the hard drive you want to test from the **HDD ID** drop down list.
2. Choose the kind of test you want to perform from the **Self-Check Type** drop down list.
  - Short Test** - Checks the electrical and mechanical performance scanning parts of the disk. Usually takes a couple of minutes.
  - Long Test** - Thoroughly checks the electrical and mechanical performance scanning the entire disk. This takes several hours.
  - Conveyance Test** - A quick test to check for damage during transport, ideally before the drive has been used for recording.
3. When you have selected the hard drive and test type click the **Check** button to perform the test.

### Reading Test Results

#### Self-check State

During the test the Self-check State will show the progress of the test as a percent. Once the test has finished it will read "Self test successfully completed".

#### TEMP(°C)

Gives a live temperature reading for the hard drive.

**Utility Time(d)**

Shows the total amount of time the hard drive has been powered on in days.

**Whole Evaluation**

States whether the hard drive has Passed or Failed the test.

**S.M.A.R.T Info**

This table shows the test result for each attribute of the hard drive.

- **ID** - The hexadecimal code of the hard drive attribute
- **Attribute Name** - The part of the hard drive being tested
- **Status** - Indicates if the hard drive attribute is OK or if it has problem
- **Flags** - These codes are set by the hard drive manufacturer and give an indication for the reason of the attributes status
- **Value** - The current health of the attribute
- **Worst** - The lowest ever value of the attribute in previous tests
- **Threshold** - The lowest the value can be before it is classed as a fail
- **Raw Value** - Raw data which is put through an algorithm designed by the manufacturer to give an indication to the attributes overall status

### 13.3 Storage Menu - Cloud

The Cloud sub-menu allows you to link your Zip recorder to a cloud storage service and automatically upload videos and snapshots captured by a motion detection trigger, an alarm input or through one of the Smart detection features. You can link your Zip recorder to either a Dropbox or a Google Drive account.

The cloud storage services supported may differ depending on the model of recorder.

Camera	Folder Name
Cam1	CH1
Cam2	CH2
Cam3	CH3
Cam4	CH4
Cam5	CH5
Cam6	CH6
Cam7	CH7
Cam8	CH8
Cam9	CH9
Cam10	CH10
Cam11	CH11

#### How Set Up Cloud Storage

Before setting up cloud storage you must have [emails](#)<sup>(252)</sup> set up as the recorder will attempt to send an activation link. The activation link will be sent to the email address in the **Receiver 1** field so the cloud storage account must be one this recipient has access to.

Once you have emails configured you can link your Zip recorder to your cloud storage by following these simple steps:

1. Tick the **Cloud Storage** check box to enable the cloud storage feature.
2. Select the cloud service you want to link to from the **Cloud Type** drop down list.
3. Click the **Activate Cloud** button to send an email containing the activation link.

#### Choosing What Is Uploaded

You can upload snapshots or video for each camera from a motion trigger, an alarm trigger or a smart detection trigger.

To do this you need to enable **Picture To Cloud** and/or **Video To Cloud** in the Alarm menu under the [Motion sub-menu](#)<sup>(220)</sup>, the [I/O sub-menu](#)<sup>(223)</sup> and/or the required smart detection feature in the [Smart sub-menu](#)<sup>(226)</sup>.



When you have set what you want to upload don't forget to check that motion detection or the smart detection feature itself is actually enabled. You can do this in the Video menu under the [Motion sub-menu](#)<sup>(159)</sup> and the [Smart sub-menu](#)<sup>(163)</sup> by ticking the **Switch** check box.

### Enabling And Disabling Cloud Storage

Once you have set up cloud storage you can enable and disable cloud storage uploads as and when required by ticking or unticking the **Cloud Storage** check box.

### Capacity

This shows how much of your cloud storage space is being used and your total cloud storage space available.

### Overwriting Old Footage

You can decide if and when old footage is overwritten from the **Cloud Overwrite** drop down list.

#### Auto

When set to Auto this will automatically overwrite old recordings with new ones when your cloud storage is full. This process will always overwrite the oldest footage first.

#### OFF

You can turn overwriting OFF so that when your cloud storage is full it will stop saving footage.

#### Specified Number Of Days

You also have the option to start overwriting old footage after a set amount of days. You can choose from 1 day up to 90 days. This is a great way to comply with **GDPR** as it will always overwrite the oldest footage first so you can confidently state "We only store footage for X days".

### Selecting A Video Format

You can choose the video format of footage saved to the cloud from the Video Type drop-down list.

#### QZIP

This is a secure, encrypted video format which is great for CCTV footage as it can only be viewed using the Zippy player

#### AVI

A high compression video format which will save a storage space but may lose image quality.

#### MP4

The most supported video format which can be played back on most devices.

## File Structure & Naming Folders

When saving footage to your cloud storage you will notice that a folder is created automatically for the recorder which starts with the recorder's [device name](#)<sup>(275)</sup> and ends with the recorder's MAC address. Inside the recorder's folder you will find a folder for each day's footage named in a year, month and date format (YYYYMMDD). Finally inside each day's folder you will find a folder for each camera which has uploaded footage or snapshots.

To make things easier you can give each camera's folder a memorable name so they are easier to find such as "Car Park" or "Reception". To do this just enter the name you want to use into the **Folder Name** field next to the corresponding camera in the Cloud sub-menu.

Once set every time footage or snapshots are uploaded for the camera they will be placed into a folder with the given name.

## Defaulting Settings

To restore settings back to the factory default you can click the **De fault** button.

## Saving Changes

When you are happy with the current settings click the **Apply** button. If you exit the window without saving any changes will be lost.

## System Menu

The System menu is where you configure the general settings of the recorder and perform maintenance.

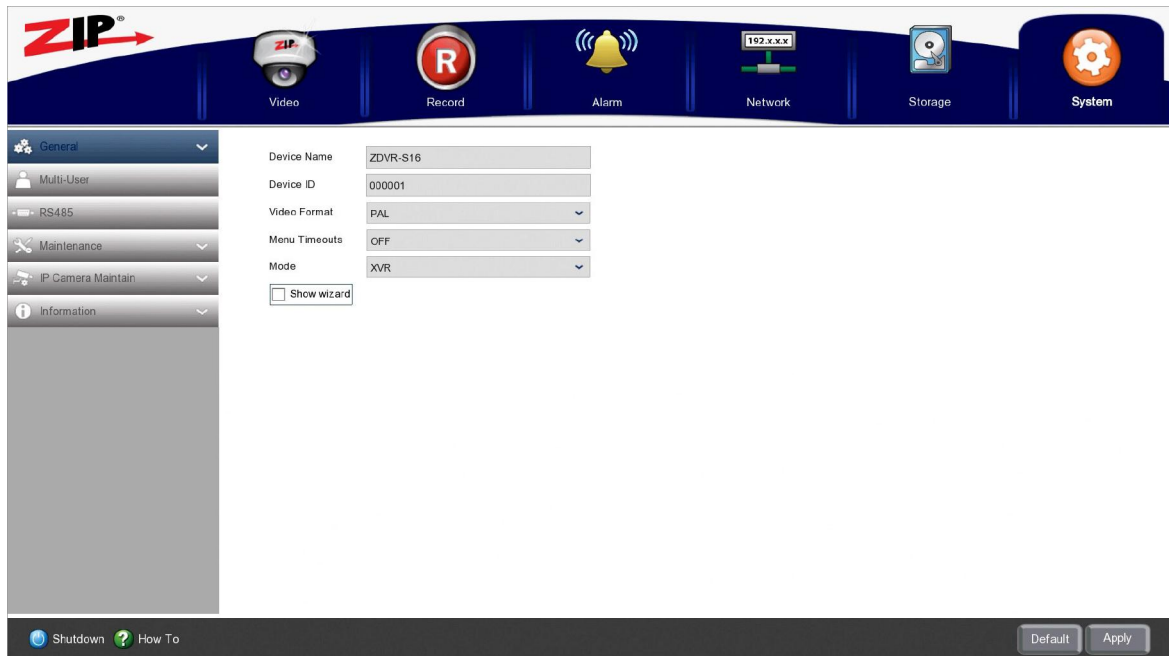

From the System menu you can access the following sub-menus and features.

### General

In the [General sub-menu](#)<sup>275</sup> you can manage the recorder's ID, time and date settings, stream friendly multi-channel output (Zip Channel) and the recorder's video output.

### Multi-User

The [Multi-User sub-menu](#)<sup>288</sup> allows you to manage the username, password and permissions for up to 7 users.

### RS485

In the [RS485 sub-menu](#)<sup>295</sup> can configure the RS485 settings used by the recorder.

### Maintenance

The [Maintenance sub-menu](#)<sup>297</sup> allows you to export or load recorder configuration settings, view and backup logs, restore defaults and schedule reboots.

## IP Camera Maintenance

From the [IP Camera Maintenance sub-menu](#)<sup>(304)</sup> you can upgrade camera firmware, load default settings, reboot IP cameras and save or load camera setting configurations..

## Information

The [Information sub-menu](#)<sup>(310)</sup> shows key information about the recorder, channels recording and the network recorder's network settings.

## 14.1 System Menu - General

In the General sub-menu you can see key information for each hard drive, format hard drives and decide if and when footage is overwritten.

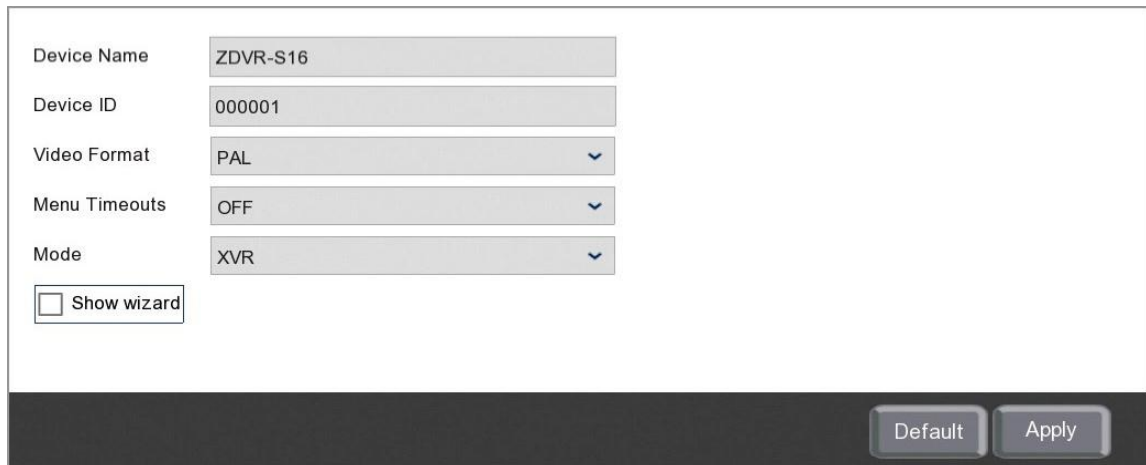

The screenshot shows a configuration window for a device. It contains the following fields and controls:

- Device Name:** ZDVR-S16
- Device ID:** 000001
- Video Format:** PAL (dropdown menu)
- Menu Timeouts:** OFF (dropdown menu)
- Mode:** XVR (dropdown menu)
- Show wizard
- Buttons:** Default and Apply

### Device Name

You can enter a more recognisable name for the recorder in the **Device Name** field to make it easier to identify the recorder when using other software and services. The Device Name will be shown as the name of the recorder in the device list on the Zip PC client software and the Zip mobile apps. This is especially useful when you have multiple recorders as you can quickly distinguish which recorder is which.

### Device ID

Setting a unique **Device ID** is a good idea if you are going to have multiple recorders in close proximity to each other. When using the recorders IR remote control you can specify which ID you want to control. By default all recorders have the same ID (000001). If all recorders are left as the default ID, you would unintentionally control every recorder within range of the IR range simultaneously rather than just the 1 recorder you did want to control.

For more information on selecting an ID to control a single recorder see the [Operation - IR Remote Control](#)<sup>(28)</sup> section.

### Video Format

You can select the format of the recorder's video output from the **Video Format** drop down list. You can choose between PAL or NTSC.

### Menu Timeouts

For security reasons the recorder will ask you to re-enter your password if you try to control it after a period of inactivity. This is to prevent anybody from accessing the recorder without authorisation.

You can set how long the period of inactivity must be before the recorder asks for the password again from the **Menu Timeouts** drop down list. By default this is set to 30 seconds but it can be set up to 10 minutes.

You can also disable the menu timeout all together by selecting **Off**, however we don't recommend this.

## Mode

Setting the **Mode** dictates what type of cameras the DVR can take on its analogue channels and what resources are available.

**XVR** - Allows you to switch analogue channels to IP channels in the Video - Channel Config sub-menu. By doing this you could have IP cameras on every channel if needed. The only downside is the extra resources the DVR allocates to processing the extra IP cameras means that there is a drop in the maximum frame rate available.

**DVR** - When setting the Mode to DVR you can not switch the analogue channels to IP to gain extra IP cameras. You can still add the usual IP cameras in addition to the analogue channels but the amount of supported IP cameras depends on the model of DVR (See Max IP Cameras). This is a good option if you don't require any extra IP cameras as the resources saved from processing them can be used on the analogue channels instead. These extra resources can be used to increase the maximum frame rate of you analogue cameras.

## Show Wizard

You can enable or disable the [Smart Setup Wizard](#)<sup>(49)</sup> by ticking or un-ticking the **Show Wizard** check box. When enabled the Smart Setup Wizard will be displayed every time the recorder starts up.

## Defaulting Settings

To restore settings back to the factory default you can click the **De fault** button.

## Saving Changes

When you are happy with the current settings click the **Apply** button. If you exit the window without saving any changes will be lost.

### 14.1.1 System Menu - General - ZIP Channel

The Zip Channel sub-menu enables you to configure a single stream which contains multiple camera images to overcome performance issues when viewing remotely on slow internet connections. Rather than trying to stream multiple channels individually you can create a split screen view of up to 16 cameras and stream it as 1 channel. This is a great tool where poor internet speeds usually prevent you from viewing multiple cameras at the same time.

Enable ZIP Channel Encoding	<input checked="" type="checkbox"/>
Frame Rate	6
Max.Bitrate Mode	General
Max.Bitrate(Kbps)	512
Mode	2 x 2
Dwell Time	No Switch

1 Cam1	2 Cam2
3 Cam3	4 Cam4

Previous Next

Default Apply

#### Enabling Zip Channel

You can enable or disable the Zip Channel feature by ticking or unticking the **Enable ZIP Channel Encoding** check box.

Once enabled you will be able to select Zip Channel from the recorder's channel list when using the Zip Vision PC client software.

#### Frame Rate

You can set the frame rate for the zip channel from the **Frame Rate** drop down list. You can choose from 1 to 6 frames per second to get the best results for the internet speed available.

#### Max.Bitrate Mode

To make setting up the Zip Channel easier the bitrate mode is set to **General**.

#### Max.Bitrate(Kbps)

You can choose the max bitrate for the Zip Channel by selecting one of the commonly used pre-set bitrates from the **Max.Bitrate(Kbps)** drop down list

Just remember that the bitrate is the amount of data transferred per second so a high bitrate will produce a high quality image but requires a faster internet speed. A low bitrate will produce a low quality image better for slower internet speeds.

## Setting Up The Split Screen Display

You can set the layout of the Zip Channels split screen display from the **Mode** drop down list. You can choose from a 1x1 up to a 4x4 grid.

Once you have chosen layout of the grid you can set which cameras appear where using the camera drop down lists in the grid preview. Just note that each camera can only appear once.

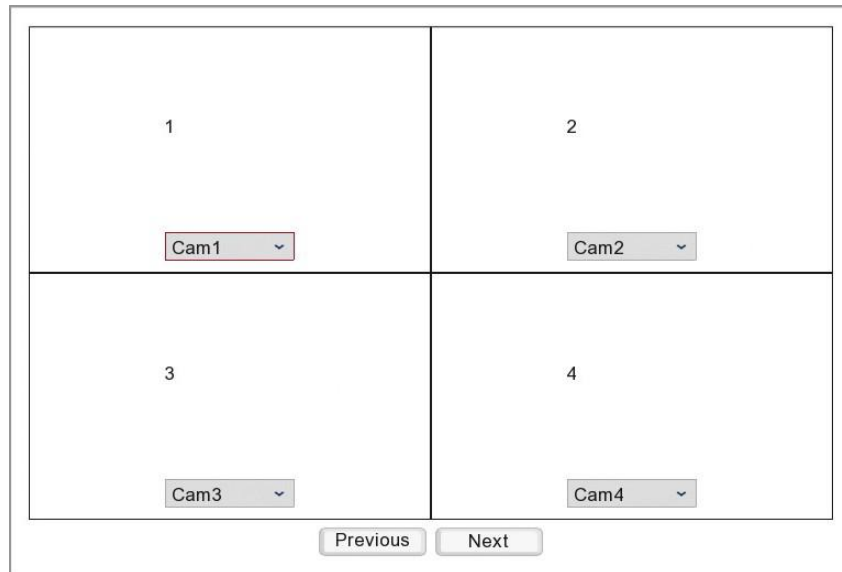

You can switch to the next or previous set of cameras by clicking the **Previous** or **Next** buttons.

## Dwell Time

The Dwell Time allows you to define how long the first set of cameras will be displayed, as shown in the grid preview, before switching to the next set of cameras. You can choose from 5 seconds up to 300 seconds. After the last set of cameras has been displayed it will loop back to the first set of cameras and the cycle will start again.

You can turn off automatic switching by setting the Dwell Time to **No Switch**. This will stop Zip Channel from cycling through each camera set and will only switch when you click Previous or Next.

## Defaulting Settings

To restore settings back to the factory default you can click the **Default** button.

## Saving Changes

When you are happy with the current settings click the **Apply** button. If you exit the window without saving any changes will be lost.



### 14.1.2 System Menu - General - Date And Time

You can configure everything regarding the recorder's date and time in the Date And Time sub-menu.

It's important to have the correct date and time set so that schedules activate at the desired time. It will also ensure that the correct date and time are overlayed on to recorded footage and snapshots. Footage with incorrect time or date could be unusable as evidence as an event could appear to occur at a different time to when it when it was reported to have happened.

**Date and Time**

Date: 11/05/2021 

Time: 12:10:50

Date Format: DD/MM/YYYY

Time Format: 24Hour

Time Zone: GMT

**NTP Settings**

Enable NTP:

Server Address: User-Defined 192.168.0.8

**DST Settings**

Enable DST:

Time Offset: 1Hour

DST Mode: Week

Start Time: Mar. The last Sun. 01:00:00

End Time: Oct. The last Sun. 02:00:00

#### Manually Setting The Date And Time

The easiest way to set the recorder's date and time is to use the NTP feature which will automatically retrieve the correct date and time from the network or router. However if you have not networked your recorder you can still set the date and time manually as described below.

To set the **Date** just click on the **Calendar** icon to display the mini calendar and select the current date.

<span>&lt;</span> Nov. <span>&gt;</span> <span>&lt;</span> 2020 <span>&gt;</span>						
SUN	MON	TUE	WED	THU	FRI	SAT
25	26	27	28	29	30	31
1	2	3	4	5	6	7
8	9	10	11	12	13	14
15	16	17	18	19	20	21
22	23	24	25	26	27	28
29	30	1	2	3	4	5

To set the **Time** just click inside the Time field and use the on-screen keypad to enter the correct time.

If your recorder had been networked but you still wish to set the date and time manually make sure you disable NTP so that the date and time aren't updated automatically.

### Date Format

You have 3 options for how the date is displayed which can be selected from the **Date Format** drop down list:

- **MM/DD/YYYY** (Month/Day/Year)
- **YYYY-MM-DD** (Year-Month-Day)
- **DD/MM/YYYY** (Day/Month/Year)

### Time Format

You can choose whether to use a **24 hour** clock (17:30) or a **12 hour** clock (5:30pm) from the **Time Format** drop down list. If you choose to use a 12 hour clock a new drop down list will appear next to the Time field so that you can set the time as **AM** or **PM**.

### Time Zone

You have the option to change the time zone so that you can use the recorder outside of the UK. This can be done in the **Time Zone** drop down list where you can specify how many hours your region is in front or behind GMT.

### Enabling NTP Automatic Date And Time

If your recorder has been networked, we recommend using the NTP (Network Time Protocol) feature which uses a time server to automatically set the correct date and time. This is an easy, hassle free way to ensure your recorder always has the correct date and time.

To configure NTP follow these steps:

1. Tick the **Enable NTP** check box.
2. Select the time server you want to use from the **Server Address** drop down list. There a 3 public time servers you can choose, **time.windows.com**, **time.nist.gov** or **pool.ntp.com**.

Alternatively if you have access to a private time server you can select **User-Defined** and enter the server's IP address.

3. Once you have selected your time server click the **Update Now** button to set your recorder to the correct date and time.

### Setting Up Daylight Saving Time

You can enable Daylight Saving Time (DST) so that the recorder keeps the right time when the clocks go forward or back. To do this follow these simple steps:

1. Tick the **Enable DST** check box to turn on Daylight Saving Time. The default settings are already configured for the UK so this is all you need to do. If you are using the recorder outside the UK proceed to step 2.
2. You can set the amount of time the clock moves forwards and back from the **Time Offset** drop down list.
3. DST can be set to occur on a specific **Date** or **Week**. You can choose the relevant option in the **DST Mode** drop down list.
4. You can set when the clocks move forward by setting the **Start Time**. The options available will differ depending on DST Mode as shown below:
  - Week** - set the month, the week in the month, the day of the week and the time of day the clocks go forward.
  - Date** - select the date and the time of day the clocks go forward.
5. Finally set when the clocks move back by setting the **End Time**. The options available will differ depending on DST Mode as shown below:
  - Week** - set the month, the week in the month, the day of the week and the time of day the clocks go back.
  - Date** - select the date and the time of day the clocks go back.

### Defaulting Settings

To restore settings back to the factory default you can click the **De fault** button.

### Saving Changes

When you are happy with the current settings click the **Apply** button. If you exit the window without saving any changes will be lost.

### 14.1.3 System Menu - General - Output Configuration

The Output Configuration menu allows you to set up the recorder's displays. You can set the output resolution, the auto sequencer parameters for the main video output and the spot monitor output, the menu transparency and the mouse cursor speed.

Video Output	LIVE-OUT	<input type="checkbox"/> Automatic recognition
Seq Mode	Layout1	
SEQ Dwell Time	5	
Output Resolution	1080P(1920x1080)	
Scale And Offset	Setup	
Cursor Hidden Delay	5s	
Cursor Acceleration	<input type="range" value="5"/>	5
Transparency	<input type="range" value="0"/>	0

Default Apply

You can make changes to the main [HDMI/VGA live view video output](#)<sup>283</sup> or the BNC spot monitor output by selecting **LIVE-OUT** or **SPOT-OUT** from the **Video Output** drop down list.

### 14.1.3.1 System Menu - General - Output Configuration - Live Out

Selecting LIVE-OUT from the Video Output drop down list in the [General Output](#)<sup>282</sup> sub-menu allows you to configure the display of the recorders live view for the HDMI and VGA outputs.

As this is the main output of the recorder this will also display the menu system and the mouse cursor.

The screenshot shows the 'Video Output' configuration window. It contains the following settings:

- Video Output: LIVE-OUT (dropdown)
- Seq Mode: Layout1 (dropdown)
- SEQ Dwell Time: 5 (text input)
- Output Resolution: 1080P(1920x1080) (dropdown)
- Scale And Offset: Setup (button)
- Cursor Hidden Delay: 5s (dropdown)
- Cursor Acceleration: Slider from 0 to 5, currently at approximately 3.5
- Transparency: Slider from 0 to 5, currently at 0
- Automatic recognition:  (checkbox)

Buttons for 'Default' and 'Apply' are located at the bottom right of the window.

You can configure the following the settings for the recorder's live view display.

### Setting The Live View Auto Switch Layout

The camera layout which is displayed when you select Auto Switch in the [Live View menu](#)<sup>32</sup> can be set in the **Seq Mode** drop down list. You can select a single channel display or one of the various multi-channel displays from the drop down list.

### Setting The Auto Switch Timing

You can choose the amount of time the recorder displays the Auto Switch layout before moving on to the next camera or group of cameras in the **SEQ Dwell Time** field. This is a free text field where you can specify in seconds how long the recorder should display each layout.

### Choosing The Recorder's Output Resolution

You can choose the resolution used for the HDMI and VGA outputs from the **Output Resolution** drop down list.

The recorder supports up to a 4K output which can be displayed over HDMI or you can display up to 1080P over VGA and HDMI. Alternatively you can click the **Automatic Recognition** check box and the recorder will set itself to the maximum resolution supported by your monitor.

## Changing The Screen Size And Position

Clicking the **Scale And Offset Setup** button will display the image scale and offset controls so that you can adjust the size and position of the recorders display on your monitor. A red rectangle shows the edges of the display so you can ensure that this is within the monitor's screen.



To adjust the **Scale** (size of display), **X Offset** (left and right position), **Y Offset** (up and down position) select the corresponding radio button and use the left and right arrows. To adjust the X or Y offset the scale must be below 100%.

## Setting When The Mouse Cursor Disappears

The **Cursor Hidden Display** drop down list allows you to set how long the mouse cursor remains visible on-screen after you last moved the mouse. This can be set from 1 second up to 2 minutes. Once you move your mouse again the cursor will reappear.

If you want the mouse cursor to remain on-screen at all times you can select **Off** from the drop down list.

## Adjusting The Speed Of The Mouse Cursor

You can set the mouse speed from 0 to 9 using the **Cursor Acceleration** slider. This controls how fast the mouse moves around the screen and you may wish to change it depending on the output resolution of the recorder. On a high resolution a fast mouse speed may help so it doesn't take too long to move around. Where as on a low resolution a slow mouse speed will stop the cursor zipping around making it difficult to control.

## Setting The Transparency Of Menus

The **Transparency** slider sets the opacity of the live view and main menu system. The slider can be set from 0 to 128 with 0 being no transparency and 128 being 50% transparency.

### 14.1.3.2 System Menu - General - Output Configuration - Spot Out

Selecting SPOT-OUT from the Video Output drop down list in the [General Output](#)<sup>282</sup> sub-menu allows you to configure the BNC spot monitor output.

The spot monitor output is ideal for monitors in public areas as it will only display the cameras and won't show the menu system or the mouse cursor.

The screenshot shows a configuration window with the following settings:

- Video Output: SPOT-OUT
- CVBS SPOT:
- View SetUp: Static
- View Mode: View Mode1
- Full Screen:

Buttons: Define SEQ Setting, Default, Apply

You can configure the following the settings for the recorder's BNC spot monitor output.

#### Enabling The Recorder's BNC Spot Monitor Output

You can enable and disable the recorder's spot monitor output by ticking or unticking the **CVBS SPOT** check box.

#### Choosing a Static Or Auto Switching Display

You have 2 options in the **View Setup** drop down list, **Static** or **Dynamic**. Static will show the same camera layout continuously where as Dynamic will automatically switch between selected cameras.

#### Choosing A Static Camera Layout

When you have Static selected from the View Setup drop down list the **View Mode** option will be displayed.

In the View Mode drop down list you can choose the camera layout which will be continuously displayed on the recorder's spot monitor output. You can select a single channel display or one of the various multi-channel displays from the drop down list.

#### Choosing Which Cameras Are Displayed In A Static Camera Layout

When you have set the View Mode you can then click the **Define SEQ Setting** button to choose which cameras appear where in the chosen layout.

Camera's can be chosen from the drop down lists for each camera position.

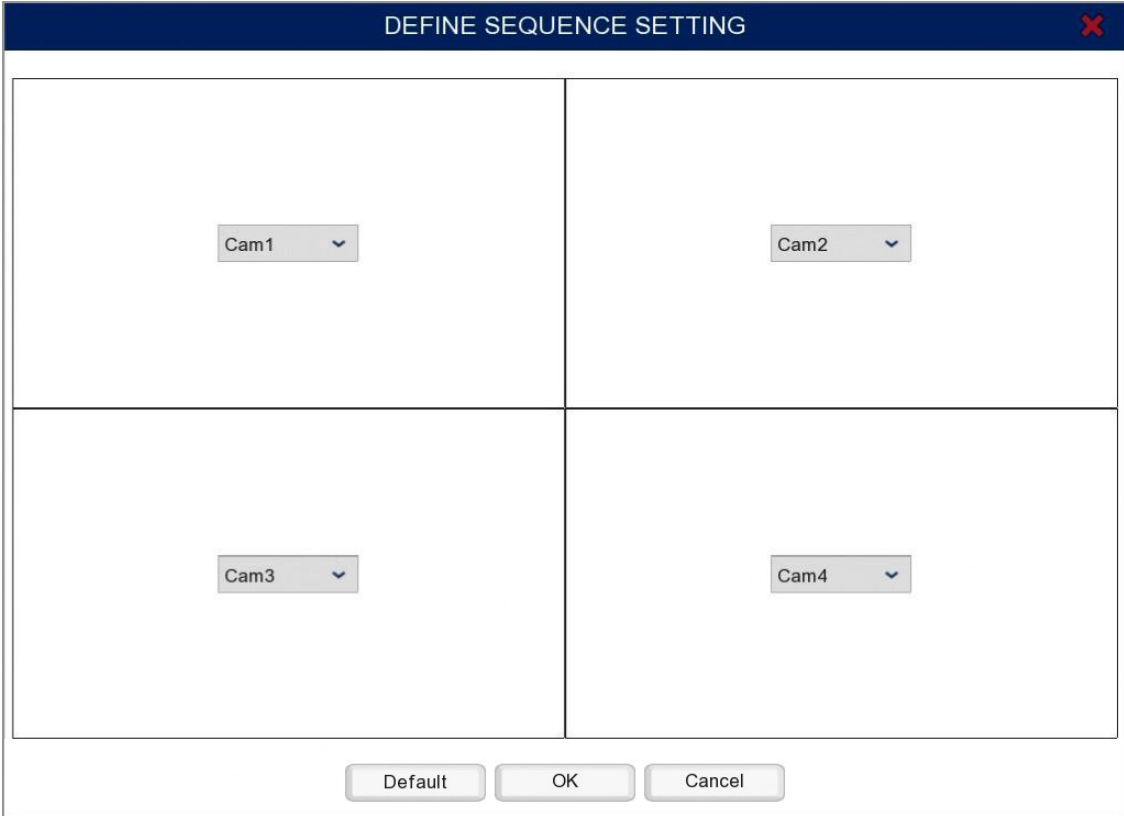

The screenshot shows a window titled "DEFINE SEQUENCE SETTING" with a close button (X) in the top right corner. The window is divided into four quadrants by a horizontal and a vertical line. Each quadrant contains a dropdown menu labeled "Cam1", "Cam2", "Cam3", and "Cam4" respectively. At the bottom of the window are three buttons: "Default", "OK", and "Cancel".

### Choosing An Auto Switching Camera Layout

When you have Dynamic selected from the View Setup drop down list the **Seq Mode** option will be displayed.

In the Seq Mode drop down list you can choose the camera layout which will be used for the auto switching display on the recorder's spot monitor output. You can select a single channel display or one of the various multi-channel displays from the drop down list.

### Setting The Auto Switch Timing

You can choose the amount of time the recorder displays each camera layout before moving on to the next in the **SEQ Dwell Time** field. This is a free text field where you can specify in seconds how long the recorder should display each layout.

### Choosing Which Cameras Appear In An Auto Switching Display

When you have set the Seq Mode you can then click the **Spot Poll Setting** button to choose which cameras you want to include in the auto switching display.

To include or exclude a camera simply tick or un-tick the corresponding check box.

When set to a single camera layout, if a camera is ticked to be included but there isn't actually a camera connected the recorder will just skip this camera.



Spot Poll Setting			
<input checked="" type="checkbox"/> Cam1	<input checked="" type="checkbox"/> Cam2	<input checked="" type="checkbox"/> Cam3	<input checked="" type="checkbox"/> Cam4
<input checked="" type="checkbox"/> Cam5	<input checked="" type="checkbox"/> Cam6	<input checked="" type="checkbox"/> Cam7	<input checked="" type="checkbox"/> Cam8
<input checked="" type="checkbox"/> Cam9	<input checked="" type="checkbox"/> Cam10	<input checked="" type="checkbox"/> Cam11	<input checked="" type="checkbox"/> Cam12
<input checked="" type="checkbox"/> Cam13	<input checked="" type="checkbox"/> Cam14	<input checked="" type="checkbox"/> Cam15	<input checked="" type="checkbox"/> Cam16
<input checked="" type="checkbox"/> W Cam1	<input checked="" type="checkbox"/> IP Cam1	<input checked="" type="checkbox"/> W Cam2	<input checked="" type="checkbox"/> IP Cam2
<input checked="" type="checkbox"/> IP Cam3	<input checked="" type="checkbox"/> IP Cam4	<input checked="" type="checkbox"/> IP Cam5	<input checked="" type="checkbox"/> IP Cam6
<input checked="" type="checkbox"/> IP Cam7	<input checked="" type="checkbox"/> IP Cam8	<input checked="" type="checkbox"/> IP Cam9	<input checked="" type="checkbox"/> IP Cam10
<input checked="" type="checkbox"/> IP Cam11	<input checked="" type="checkbox"/> IP Cam12	<input checked="" type="checkbox"/> IP Cam13	<input checked="" type="checkbox"/> IP Cam14
<input checked="" type="checkbox"/> IP Cam15	<input checked="" type="checkbox"/> IP Cam16	<input checked="" type="checkbox"/> IP Cam17	<input checked="" type="checkbox"/> IP Cam18
<input checked="" type="checkbox"/> IP Cam19	<input checked="" type="checkbox"/> IP Cam20	<input checked="" type="checkbox"/> IP Cam21	<input checked="" type="checkbox"/> IP Cam22

You can also select or deselect all cameras at the same time by clicking the **All** or **Clear** buttons respectively.

### Enabling Full Screen On Motion Or Alarm Trigger

In the [Alarm Menu](#) <sup>(218)</sup> you can configure the recorder to display a camera's image full screen when motion is detected, an alarm is triggered or a smart detection feature is triggered.

By default this only happens on the HDMI and VGA live view display. If you want the BNC spot monitor output to do the same simply tick the **Full Screen** check box.

### Defaulting Settings

To restore settings back to the factory default you can click the **Default** button.

### Saving Changes

When you are happy with the current settings click the **Apply** button. If you exit the window without saving any changes will be lost.

## 14.2 System Menu - Multi-User

In the Multi-User sub-menu you can create additional user accounts and set their permissions so each user can only view and control what the administrator allows.

No.	Username	Level	User Enable	User Edit	Permission
1	admin	ADMIN	Enable		
2	user1	USER1	Disable		
3	user2	USER2	Disable		
4	user3	USER3	Disable		
5	user4	USER4	Disable		
6	user5	USER5	Disable		
7	user6	USER6	Disable		

Default User:

### User Account Number

You can have up to 7 active user accounts as shown in the **No.** column.

### Account Username

You can assign a unique username to each account in the [User Edit window](#)<sup>(290)</sup>.

### Account Level

The **Level** column shows the user account level so you can see which account is the Admin account and which are standard User accounts.

The Admin account is the master user who has absolute control of the recorder. A standard User account can only view and control what the Admin user allows them to.

### Enabling And Disabling User Accounts

You can enable and disable individual user accounts as shown in the [User Edit window](#)<sup>(290)</sup>.

### Editing A User Account

Clicking the **Edit** icon in the **User Edit** column will open the [User Edit window](#)<sup>(290)</sup> for the corresponding user account. In the User Edit window you can enable user accounts, edit user account names and set passwords.

### Setting Permissions

Clicking the **Cog** icon in the **Permissions** column will display the [User Permissions window](#)<sup>(293)</sup>. From here you can set what permissions each user has along with which cameras they can view live, playback, backup or control.

### Defaulting Settings

To restore settings back to the factory default you can click the **De fault** button.

### Saving Changes

When you are happy with the current settings click the **Apply** button. If you exit the window without saving any changes will be lost.

### 14.2.1 System Menu - Multi-User - User Edit

In the User Edit window you can amend the username and password for the selected user account. To edit user accounts you have to be logged on to the recorder as the Admin user.

The screenshot shows a 'User Edit' window with the following fields and values:

Level	USER1
User Enable	Enable
Username	user1
Password Strength	Low
Password	•••••
Confirm	•••••
Unlock Pattern Enable	Enable

At the bottom right of the window, there is a 'Draw' icon and three buttons: 'Default', 'Save', and 'Cancel'.

#### User Level

The **Level** shows the status of the user account, Admin or User.

#### Enabling And Disabling User Accounts

When you enter the User Edit window of a User level account you will see a **User Enable** drop down list. From here you can choose to **Enable** or **Disable** the selected user account.

#### Account Username

You can set a unique name for each user account in the **Username** field. The username can be up to 16 characters long and can be a mixture of uppercase and lowercase letters, numbers and symbols.

#### Setting A Password

To set a new password or change an existing password you need to enter the desired password into the **Password** field. You will then need to re-enter the new password into the **Confirm** field. This Password field and the Confirm field will be checked against each other to ensure that they match and you haven't accidentally entered the new password incorrectly.

The **Password Strength** bar gives you an indication as to how secure your password is. A low strength password may be easy for somebody to guess where as a high strength password would keep you more secure. Ideally you would aim for as strong of a password as possible by using at least 8 characters and a combination of letters and number.

## Enabling And Disabling User Accounts

You can enable and disable individual user accounts as shown in the [User Edit window](#) <sup>(290)</sup>.

### Creating An Unlock Pattern

For the Admin account you can also set an Unlock Pattern similar to the ones used on mobile phones. When a pattern has been set you can use this to unlock the recorder rather than the password.

To setup an Unlock Pattern choose **Enable** from the **Unlock Pattern Enable** drop down list then click the **Edit** icon.

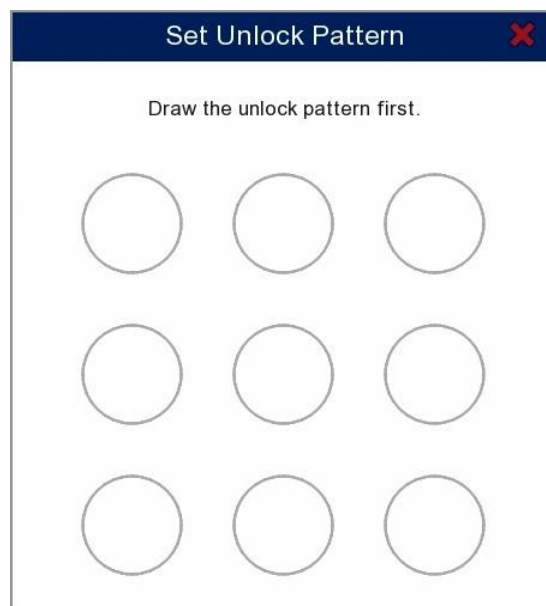

To set a new unlock pattern or to update an existing pattern just follow the steps below:

1. Left click and hold on the circle where you want your pattern to start.
2. Keeping the left mouse button pressed, draw your desired pattern through the other circles. Be aware, you can only select each circle once.
3. When finished release the left mouse button.
4. You will be asked to draw the same pattern again to confirm it. The window will close when successful.

To unlock the recorder using an unlock pattern simply re-draw the pattern in the same way.

If you ever forget your unlock pattern you can unlock the recorder using the admin password by clicking the **Password** button.

### Defaulting Settings

To restore settings back to the factory default you can click the **Default** button.

### Saving Changes

When you are happy with the current settings click the **Save** button. For security you will be asked to authenticate the changes by entering for admin password. If you exit the window without saving any changes will be lost.

### 14.2.2 System Menu - Multi-User - Permission

In the User Permission window the Admin user can set the permissions for each individual standard user to control what they can access and what actions they can perform.

The screenshot shows the 'User Permission' window for user 'user1'. It contains several sections of permissions:

- General Permissions:** Log Search, Parameter, Auto Reboot, Manual Record, Disk, Remote Login, SEQ Control, Manual Capture.
- Backup:** A checkbox for 'Backup' followed by three sub-sections: 'Analogue Channels' (grid 1-16), 'IP Camera' (grid 1-16, 17-22), and 'USB Wireless' (grid 1-2).
- Live:** A checkbox for 'Live' followed by three sub-sections: 'Analogue Channels' (grid 1-16), 'IP Camera' (grid 1-16, 17-22), and 'USB Wireless' (grid 1-2).
- Playback:** A checkbox for 'Playback' followed by three sub-sections: 'Analogue Channels' (grid 1-16), 'IP Camera' (grid 1-16, 17-22), and 'USB Wireless' (grid 1-2).
- PTZ:** A checkbox for 'PTZ' followed by three sub-sections: 'Analogue Channels' (grid 1-16), 'IP Camera' (grid 1-16, 17-22), and 'USB Wireless' (grid 1-2).

At the bottom of the window are four buttons: 'All', 'Clear', 'Save', and 'Cancel'.

#### Setting What Actions A User Can Perform

There are 8 check boxes you can enable or give a user permission to perform certain actions as described below. You can always untick the check boxes to remove permissions at a later date.

**Log Search** - Allows the user to search the recorder's activity log as explained in the [Maintenance - Log<sup>297</sup>](#) section.

**Parameter** - Gives the user permission to make changes to the recorder's settings in the menu system.

**Auto Reboot** - When enabled the user can schedule auto reboots for the recorder or remove scheduled auto reboots as shown in the [Maintenance - Auto Reboot<sup>303</sup>](#) section.

**Manual Record** - Allows the user to start manual recordings for the channels they are allowed to view.

**Disk** - Lets the user format the recorder's hard drives with the admin user's authorisation. For more information see the [Storage Menu - Disk](#) <sup>(266)</sup> section.

**Remote Login** - When enabled the user can login remotely from the PC client software, Internet Explorer browser or the mobile app.

**Seq Control** - Allows the user to start auto switching between the channels they are allowed to view in [Live View](#) <sup>(32)</sup>.

**Manual Record** - Lets the user to take manual snapshots from the channels they are allowed to view.

### Setting What Channels The User Has Access To

You can set which channels the user has access to Backup from, view Live, Playback or control the PTZ settings for as explained below:

1. Tick the check box next to Backup, Live, Playback or PTZ to enable them.
2. You can tick the check box for Analogue Channels, IP Cameras or USB Wireless to enable all channels of that type.
3. Alternatively you can select individual channel numbers to restrict access to specific channels.

### Giving A User All Permissions

If you intend to give a user all available permissions you can quickly press the **All** button rather than having to set them all individually.

### Removing All Permissions From A User

You can remove all permissions from a user in one go by clicking the **Clear** button.

### Saving Changes

When you are happy with the current settings click the **Save** button. If you want to exit without saving changes you can click the **Cancel** button.



## 14.3 System Menu - RS485

You can configure the recorder's RS485 output signals in the RS485 menu.

**Note** - These settings need to match the settings of the RS485 device you are wanting to control via the recorder. You can then send your RS485 commands from the **Kontrol** tab in the Zip Vision PC client software.

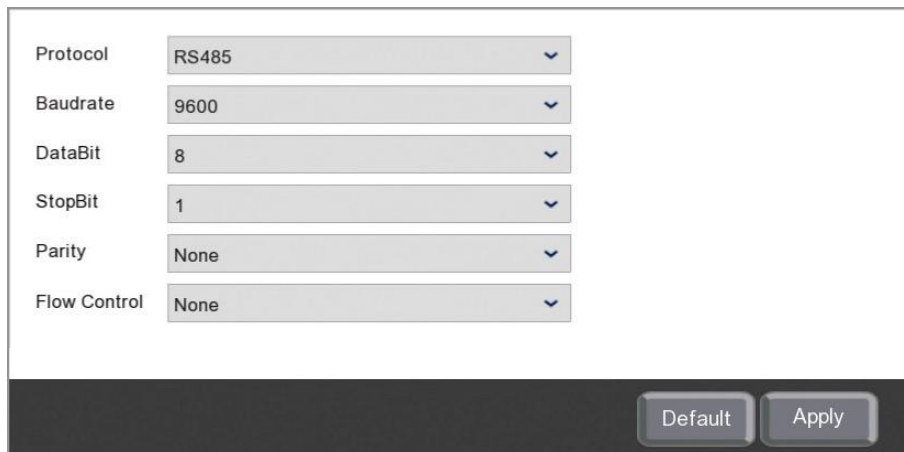

Protocol	RS485
Baudrate	9600
DataBit	8
StopBit	1
Parity	None
Flow Control	None

Default Apply

### Baudrate

This is the address setting and the speed of communication. You can choose the baudrate that matches your device from the drop down list.

### Data Bit

The Data Bit is the amount of data sent in each data package. This can be set from 5 to 8 in the drop down list.

### Stop Bit

The Stop Bit is sent after a data package so that the device knows that was the end of the data package. This can be set as 1 or 2 from the drop down list.

### Parity

The Parity is the error checking of transmitted data. This can be set to None, Odd, Even, Mark or Space from the drop down list.

### Flow Control

For the Flow Control you can select None, Software for XOn / XOff commands or Hardware if handshaking is required.

### Defaulting Settings

To restore settings back to the factory default you can click the **Default** button.

### Saving Changes

When you are happy with the current settings click the **Apply** button. If you exit the window without saving any changes will be lost.

## 14.4 System Menu - Maintenance

In the Maintenance sub-menu you can perform the following routine recorder maintenance:

- [Log](#)<sup>(297)</sup> - View and backup recorder activity logs.
- [Load Default](#)<sup>(300)</sup> - Load the default settings for entire sub menus.
- [Upgrade](#)<sup>(301)</sup> - Upgrade the recorders firmware.
- [Settings Save/Load](#)<sup>(302)</sup> - Save your recorders settings as a backup, to load onto another recorder or load settings saved from another recorder.
- [Auto Reboot](#)<sup>(303)</sup> - Schedule the recorder to reboot a set times to reload everything and make sure everything is running correctly.

### 14.4.1 System Menu - Maintenance - Log

In the Log screen you can generate an activity log for the recorder to show what events have happened and when.

With this handy feature you can check things like when alarms were triggered, when the recorder was shut down and when users logged in.

The screenshot shows the Log screen interface. At the top, there are search filters for Start Date (24/05/2021), End Date (24/05/2021), Start Time (00:00:00), End Time (23:59:59), and Log Type (All). A Search button is located to the right of the Log Type dropdown. Below the filters is a table with the following columns: Camera, Type, TIME, CON., RECORD, and Playback. The table contains 12 rows of log entries. At the bottom right of the table, there are navigation icons: a left arrow, a page number '1', a right arrow, and a refresh icon. A Backup button is located at the bottom right of the screen.

Camera	Type	TIME	CON.	RECORD	Playback
IP Cam3	Record	24/05/2021 08:03:13	Manual Record Start		
	Account	24/05/2021 08:03:14	admin Login		
	System	24/05/2021 08:03:16	System Startup		
	System	24/05/2021 08:03:28	NTP		
IP Cam1	Alarm	24/05/2021 08:03:49	FD Start	Yes	
IP Cam2	Alarm	24/05/2021 08:03:50	PD Start	Yes	
IP Cam1	Alarm	24/05/2021 08:04:18	FD End	Yes	
IP Cam2	Alarm	24/05/2021 08:04:19	PD End	Yes	
Cam1	Alarm	24/05/2021 08:04:36	Motion Start	Yes	
IP Cam2	Alarm	24/05/2021 08:04:47	PD Start	Yes	
W Cam1	Alarm	24/05/2021 08:04:52	VIDEO LOSS	No	
W Cam1	Alarm	24/05/2021 08:04:58	VIDEO LOSS	No	

### Setting The Start Date And Time

The first thing to do when generating an activity log is to set the date and time you want the log to start from.

To set the start date click the **Calendar** icon in the **Start Date** field to display the calendar screen as shown below.

◀		Nov.		▶		◀		2020		▶	
SUN	MON	TUE	WED	THU	FRI	SAT					
25	26	27	28	29	30	31					
1	2	3	4	5	6	7					
8	9	10	11	12	13	14					
15	16	17	18	19	20	21					
22	23	24	25	26	27	28					
29	30	1	2	3	4	5					

You can change month and year using the blue arrows then select a date by clicking on it.

Once you have set the date you can set the time of day you want the activity log to start from in the **Start Time** field.

### Setting The End Date And Time

After you have set the when you want the log to start you need to set when you want the log to finish. The recorder will then show activity between these times.

You can set the end date and time in the same way as you did the start date and time above only this time using the **End Date** and **End Time** fields.

### Choosing What Events Are Included In The Log

You can choose what events are included in the activity log from the **Log Type** drop down list. Logs can be generated for all event types or you could generate a log for a specific event type.

The following logs can be generated

- **All** - This will produce a cover all log which includes every log type.
- **System** - A System log will show events like system start up, shut downs and reboots.
- **Configuration** - A Configuration log will show when menu settings have been changed.
- **Alarm** - An Alarm log shows what alarms or detection features were triggered and when.
- **Account** - An Account log will show when accounts were modified and when users have logged in or out.
- **Record** - A Record log shows when manual recording or playback was started and when footage has been searched for.
- **Storage** - A Storage log will show when hard drive errors have occurred and when hard drives have been formatted.

### Generating A Log

When you have set your start date and time, end date and time and the log type, click the **Search** button to generate the log.

## Understanding The Log

The log will be displayed as a table in 6 columns with 1 event per line as described below:

- **Camera** - Shows what camera the event occurred on.
- **Type** - Shows the type of event.
- **Time** - Displays the date and time the event occurred.
- **Con.** (Condition) - Gives a brief description of the event.
- **Record** - Indicates whether the event triggered a recording.
- **Playback** - Displays a playback icon if a recording was triggered. Clicking the icon will start playback of the footage.

For more information on playing back footage see the [Playback](#)<sup>(64)</sup> section.

## Viewing All Records In A Log

When a large number of events are found they will appear over multiple pages. To switch between pages use the control arrows in the bottom right corner.



## Saving A Log

You can save the logs you generate as a .TXT file to a USB device by clicking the Backup button. For more information on backing up logs see the [Backup](#)<sup>(317)</sup> section.

### 14.4.2 System Menu - Maintenance - Load Default

The Load Default sub-menu allows you to quickly restore default settings to all or a selection of the recorder's top level sub-menus. Sometimes if you are unable to pin-point which settings are causing a problem it's easier to restore default settings and start afresh.

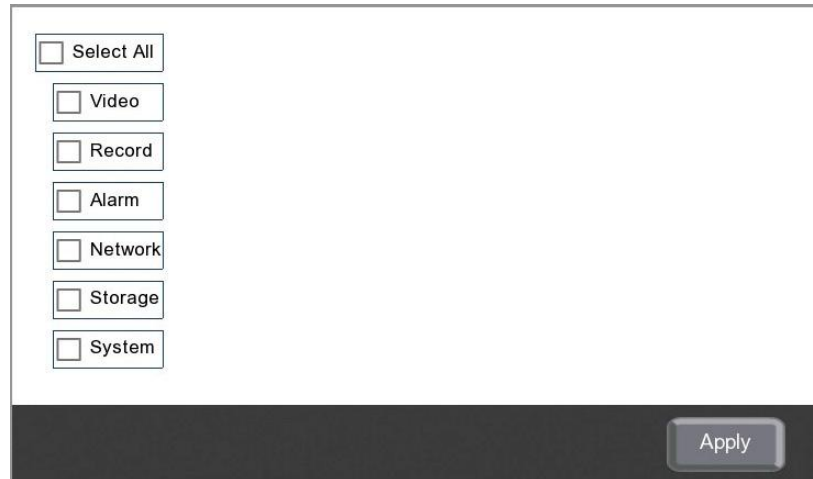

The screenshot shows a web interface for restoring default settings. It contains a list of seven items, each with an unchecked checkbox:

- Select All
- Video
- Record
- Alarm
- Network
- Storage
- System

An **Apply** button is positioned at the bottom right of the interface.

#### Selecting The Defaults To Restore

You can choose to restore all of the recorder's default settings by ticking the **Select All** check box.

If you only want to restore default settings to one of or a selection of the recorder's sub-menus simply tick the relevant check boxes.

#### Restoring Default Settings

When you have selected which default settings you want to restore just click the **Apply** button.

### 14.4.3 System Menu - Maintenance - Upgrade

In the Upgrade sub-menu you can upgrade the recorder's firmware version to add new features or resolve firmware issues.

You should only need to do this if instructed to by a member of our technical support team. If this is the case you will be supplied with a download link or website address from where you can download the new firmware file.



#### How To Upgrade The Recorder's Firmware

To upgrade the recorder's firmware just follow these simple steps:

1. Download the firmware file to your computer.
2. Copy the firmware file onto a USB memory stick.
3. Plug the USB memory stick into your recorder and click the **Select File** button.
4. Navigate to the firmware file, select it and click **OK**.
5. Click the **Upgrade** button and enter the admin user password for authorisation.

#### 14.4.4 System Menu - Maintenance - Settings Save/Load

In the Settings Save/Load sub-menu you can save the recorder's current settings as a backup or to load onto another Zip recorder. You can also load previously saved settings from the same recorder or another Zip recorder.

This feature is typically used when you have multiple recorders on the same site or over multiple sites. It allows you to configure one recorder as required and then load those settings onto your other recorders rather than having to repeat the setup process again and again.

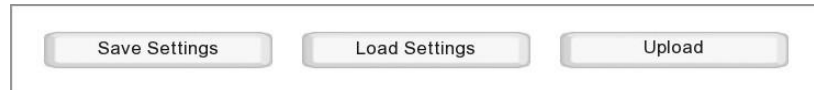

##### Saving Settings

To save the settings from your recorder follow these simple steps:

1. Insert a USB backup device into your recorder.
2. Click the **Save Settings** button.
3. Choose where you want to save your settings file and click **OK**. For more information saving to a USB device see the [Backup<sup>\(317\)</sup>](#) section.
4. Enter the admin user password for authorisation.

Settings files will be named as the recorder's serial number followed by \_Settings.

##### Loading Settings

You can load previously saved settings from your recorder or another Zip recorder as long as they are the same model and on the same firmware version. Just follow these simple steps:

1. Insert the USB backup device which contains the settings file into your recorder.
2. Click the **Load Settings** button.
3. Navigate to the settings file, select it and click **OK**.
4. Enter the admin user password for authorisation.
5. The recorder will then reboot and start up with the new settings.



### 14.4.5 System Menu - Maintenance - Auto Reboot

Like most electrical devices such as PCs, CCTV recorders have hundreds of processes which can stop working and the device requires a reboot so that everything starts up correctly again. As your recorder is an integral part of your security system you don't want to come back to it when it's needed and find that something has failed. With this in mind the Auto Reboot sub-menu allows you to schedule reboots so that you can be confident everything is running as it should.

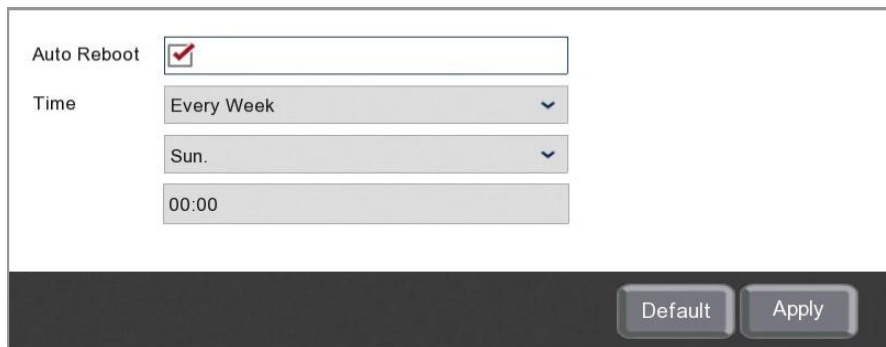

The screenshot shows a configuration window for 'Auto Reboot'. It contains a checked checkbox for 'Auto Reboot', a dropdown menu for 'Time' set to 'Every Week', another dropdown menu for the day set to 'Sun.', and a text field for the time set to '00:00'. At the bottom right, there are two buttons: 'Default' and 'Apply'.

#### Enabling Or Disabling Auto Reboots

To enable or disable auto reboots just tick or untick the **Auto Reboot** check box.

#### Choosing When The Recorder Will Reboot

There are 3 options to choose from for when the recorder will reboot in the **Time** drop down list; Everyday, Every Week or Every Month.

##### Everyday

If you choose to reboot the recorder Everyday you then need to set what time the recorder will reboot each day.

##### Every Week

If you choose to reboot the recorder Every Week you then need to set which day of the week and at what time the recorder will reboot.

##### Every Month

If you choose to reboot the recorder Every Month you will need to set the date in the month and at what time the recorder will reboot.

#### Defaulting Settings

To restore settings back to the factory default you can click the **Default** button.

#### Saving Changes

When you are happy with the current settings click the **Apply** button. If you exit the window without saving any changes will be lost.

## 14.5 System Menu - IP Camera Maintenance

In the IP Camera Maintenance sub-menu you can perform the following routine maintenance:

- [Upgrade](#)<sup>(305)</sup> - Upgrade the cameras firmware from the recorder.
- [Load Default](#)<sup>(306)</sup> - Load the default settings onto IP cameras.
- [Reboot IPC](#)<sup>(307)</sup> - Reboot IP cameras from the recorder fix certain issues.
- [Settings Save/Load](#)<sup>(308)</sup> - Save a camera's settings as a backup, to load onto another camera or load settings saved from another camera.

### 14.5.1 System Menu - IP Camera Maintenance - Upgrade

In the Upgrade sub-menu you can upgrade the firmware on IP camera's from the recorder. This could be to add new features to the camera or resolve firmware issues.

You should only need to do this if instructed to by a member of our technical support team. If this is the case you will be supplied with a download link or website address from where you can download the new firmware file.

<input type="checkbox"/>	Camera	IP Address	State	Software Version	Upgrade
<input type="checkbox"/>	IP CH1	192.168.0.168	On-line	V12.45.6.0_210107	
<input type="checkbox"/>	IP CH2	192.168.0.237	On-line	V12.45.6.0_210107	
<input type="checkbox"/>	IP CH4	192.168.0.242	On-line	V12.45.6.0_210107	

#### IP Camera Details

The key information for each camera is shown followed:

**Camera** - Shows the IP channel number the camera is assigned to.

**IP Address** - Shows the IP address of the IP camera.

**State** - Indicates the camera's current state, On-line, Off-line etc

**Software Version** - Displays the camera's current software version.

#### How To Upgrade Camera Firmware

You can upgrade a single camera or multiple camera's firmware at the same time, just follow these simple steps:

1. Download the firmware file to your computer.
2. Copy the firmware file onto a USB memory stick.
3. Plug the USB memory stick into your recorder.
4. Select the cameras you want to upgrade using the check boxes and click the **Select File** button.
5. Navigate to the firmware file, select it and click **OK**.
6. Click the **Upgrade** button and enter the recorder's admin user password for authorisation.

The State field will change to "....." while in progress and then "Success" when complete. The camera may then drop Off-line for a few seconds just while the recorder is adjusting to the new camera settings.

### 14.5.2 System Menu - IP Camera Maintenance - Load Default

The Load Default sub-menu allows you to quickly restore default settings to a single IP camera or a selection of IP cameras. Sometimes if you are unable to pin-point which settings are causing a problem it's easier to restore default settings and start afresh.

<input type="checkbox"/>	Camera	IP Address	State	Software Version
<input type="checkbox"/>	IP Cam1	192.168.0.168	On-line	V12.45.6.0_210107
<input type="checkbox"/>	IP Cam2	192.168.0.237	On-line	V12.45.6.0_210107
<input type="checkbox"/>	IP Cam4	192.168.0.242	On-line	V12.45.6.0_210107

#### IP Camera Details

The key information for each camera is shown followed:

**Camera** - Shows the IP channel number the camera is assigned to.

**IP Address** - Shows the IP address of the camera.

**State** - Indicates the camera's current state, On-line, Off-line etc

**Software Version** - Displays the camera's current software version.

#### Loading Default Settings

To restore the default settings to a camera follow these steps:

1. Tick the check boxes for the cameras you want to restore default settings to.
2. Click the **Load Default** button.
3. Enter the recorder's admin user password for authorisation.
4. A message window will appear with a 60 second countdown while the default settings are restored.

The State field will change to "....." while in progress and then "Success" when complete. The camera may then drop Off-line for a few seconds just while the recorder is adjusting to the new camera settings.

### 14.5.3 System Menu - IP Camera Maintenance - Reboot IPC

IP cameras run lots of little processes which can stop working and prevent the camera from functioning properly. If you encounter a fault with an IP camera this may be the case. To try and overcome a fault on an IP camera you can try rebooting the camera so that everything starts up correctly again.

<input type="checkbox"/>	Camera	IP Address	State	Software Version
<input type="checkbox"/>	IP Cam1	192.168.0.168	On-line	V12.45.6.0_210107
<input type="checkbox"/>	IP Cam2	192.168.0.237	On-line	V12.45.6.0_210107
<input type="checkbox"/>	IP Cam3	192.168.0.238	On-line	V6.21.5.0_190725
<input type="checkbox"/>	IP Cam4	192.168.0.242	On-line	V12.45.6.0_210107

#### IP Camera Details

The key information for each camera is shown followed:

**Camera** - Shows the IP channel number the camera is assigned to.

**IP Address** - Shows the IP address of the IP camera.

**State** - Indicates the camera's current state, On-line, Off-line etc

**Software Version** - Displays the camera's current software version.

#### Rebooting IP Cameras

To reboot an IP camera follow these simple steps:

1. Tick the check boxes for the IP cameras you want to reboot.
2. Click the **Reboot IPC** button.
3. Enter the recorder's admin user password for authorisation.

The State field will change to "....." while in progress and then "Success" when complete. The camera may then drop Off-line for a few seconds just while it reboots before coming back On-line.

### 14.5.4 System Menu - IP Camera Maintenance - Settings Save/Load

In the Settings Save/Load sub-menu you can save settings from an IP camera as a backup if needed in the future. You can also load previously saved settings from the same camera.

This feature is typically used when you encounter problems that could be a result of incorrect setting in the camera. If this happens you can then load your previously saved settings from a time you know the camera was working correctly.

<input type="checkbox"/>	Camera	IP Address	State	Software Version
<input type="checkbox"/>	IP Cam1	192.168.0.168	On-line	V12.45.6.0_210107
<input type="checkbox"/>	IP Cam2	192.168.0.237	On-line	V12.45.6.0_210107
<input type="checkbox"/>	IP Cam3	192.168.0.238	On-line	V6.21.5.0_190725
<input type="checkbox"/>	IP Cam4	192.168.0.242	On-line	V12.45.6.0_210107

#### IP Camera Details

The key information for each camera is shown followed:

**Camera** - Shows the IP channel number the camera is assigned to.

**IP Address** - Shows the IP address of the IP camera.

**State** - Indicates the camera's current state, On-line, Off-line etc

**Software Version** - Displays the camera's current software version.

#### Saving Settings

To save the settings from a camera or multiple cameras follow these simple steps:

1. Insert a USB backup device into your recorder.
2. Tick the check boxes for the IP cameras you want to save settings from.
3. Click the **Save Settings** button.
4. Enter the recorder's admin user password for authorisation.
5. Choose where you want to save your settings file and click **OK**. For more information saving to a USB device see the [Backup<sup>\(317\)</sup>](#) section.

Settings files will be named as ipcParamPage\_IP followed by the channel number of the camera.

The State field will change to "....." while in progress and then "Success" when complete.

#### Loading Settings

To load previously saved settings from your camera just follow these simple steps:

1. Insert a USB backup device into your recorder.

2. Tick the check boxes for the IP cameras you want to load the settings onto.
3. Click the **Load Settings** button.
4. Enter the recorder's admin user password for authorisation.
5. Navigate to the settings file, select it and click **OK**.

The State field will change to "....." while in progress and then "Success" when complete. The camera may then drop Off-line for a few seconds just while the recorder is adjusting to the new camera settings.

## 14.6 System Menu - Information

The Information screen is a great reference tool when you need to quickly check some of the recorder's key information from model and serial number to firmware version and P2P ID.

Device ID	000001
Device Name	ZDVR-S16
Model No.	ZDVR-S16
Serial ID	JPV00000
Hardware Version	DM-404
Software Version	V8.1.0-20200418
IE Client Version	V2.0.0.409
Video Format	PAL
HDD Volume	2794GB
IP Address	192.168.0.241
IPv6 Address	2000::1 / 64
Web	80,80
Client	8240,8240
MAC Address	38-B1-9E-B0-03-96
Network State	connect success
P2P ID	ZIPA03775JPV00000



### Device ID

The recorder's Device ID is handy when you are using the IR remote control as it allows you to target a specific recorder rather than controlling all recorders in range.

The Device ID can be set in the [System Menu - General](#)<sup>(275)</sup>. For information on choosing which ID to control see the [IR Remote Control](#)<sup>(28)</sup> section.

### Device Name

The recorder's Device Name is how it will appear in the device list on the PC client software and mobile apps. You can change the device name in the [System Menu - General](#)<sup>(275)</sup> section.

### Serial ID

This is the recorder's unique serial number. This is included in the DNS address and P2P ID as they are specific to your recorder. You will also need this for support purposes.



## Hardware Version

The Hardware Version shows the recorder's exact model. This will only ever be required for support purposes.

## Software Version

This is where you can see the recorder's current firmware version. The recorder's firmware can be updated as explained in the [Maintenance - Upgrade](#)<sup>(301)</sup> section.

## IE Client Version

This is the Internet Explorer client version the recorder runs when connected to remotely via the web browser

## Video Format

This shows the format of the recorder's video output. You can set this in the [System Menu - General](#)<sup>(275)</sup>.

## HDD Volume

The HDD Volume shows total storage capacity of all the recorder's hard drives combined.

## Network Settings

The network settings shows the recorder's IP address and ports. These are important when connecting to the recorder remotely. For more information on the recorder's IP address see the [Network Menu - General](#)<sup>(243)</sup> section. To set the ports used see the [Port Configuration](#)<sup>(247)</sup> section.

## P2P ID

The P2P ID and the QR code are a really quick and easy way of networking your recorder. For more information on how this works see the [Smart Setup - P2P](#)<sup>(58)</sup> section.

### 14.6.1 System Menu - Information - Channel Information

The Channel Information screen is a quick reference point for the basic information, stream settings and capabilities of each camera.

Camera	Camera Name	State	Mainstream	Substream	Mobilestream	Motion Detection	Privacy Zone
Cam1	CH1	Enable	1280x1944, 14Fps, 2Mbps	704x 480, 5Fps, 512Kbps	Not supported	Support	Support
Cam2	CH2	Enable	1920x1080, 13Fps, 2Mbps	704x 576, 5Fps, 512Kbps	Not supported	Support	Support
Cam3	CH3	Enable	1280x1944, 14Fps, 2Mbps	704x 576, 5Fps, 512Kbps	Not supported	Support	Support
Cam4	CH4	Enable	1920x1080, 13Fps, 2Mbps	704x 576, 5Fps, 512Kbps	Not supported	Support	Support
Cam5	CH5	Enable	1280x1944, 14Fps, 2Mbps	704x 480, 5Fps, 512Kbps	Not supported	Support	Support
Cam6	CH6	Enable	1920x1080, 13Fps, 2Mbps	704x 576, 5Fps, 512Kbps	Not supported	Support	Support
Cam7	CH7	Enable	960x 576, 25Fps, 2Mbps	704x 576, 5Fps, 512Kbps	Not supported	Support	Support
Cam8	CH8	Enable	1920x1080, 13Fps, 2Mbps	704x 576, 5Fps, 512Kbps	Not supported	Support	Support
Cam9	CH9	Enable	1920x1080, 13Fps, 2Mbps	704x 576, 5Fps, 512Kbps	Not supported	Support	Support
Cam10	CH10	Enable	1920x1080, 13Fps, 2Mbps	704x 576, 5Fps, 512Kbps	Not supported	Support	Support
Cam11	CH11	Enable	1920x1080, 13Fps, 2Mbps	704x 576, 5Fps, 512Kbps	Not supported	Support	Support
Cam12	CH12	Enable	1920x1080, 13Fps, 2Mbps	704x 576, 5Fps, 512Kbps	Not supported	Support	Support
Cam13	CH13	Enable	1920x1080, 13Fps, 2Mbps	704x 576, 5Fps, 512Kbps	Not supported	Support	Support
Cam14	CH14	Enable	1920x1080, 13Fps, 2Mbps	704x 576, 5Fps, 512Kbps	Not supported	Support	Support
Cam15	CH15	Enable	1920x1080, 13Fps, 2Mbps	704x 576, 5Fps, 512Kbps	Not supported	Support	Support
Cam16	CH16	Enable	1920x1080, 10Fps, 2Mbps	704x 576, 5Fps, 512Kbps	Not supported	Support	Support

#### Camera

The Camera column shows the channel number of the recorder.

#### Camera Name

This shows the name given to each camera. By default it will just be the recorder's channel but you can set a more meaningful name as explained in the [Video Menu - Live](#)<sup>(147)</sup> section.

#### State

Shows the current state of the camera.

For analogue cameras this will show as **Enable** unless the channel has been switched to an IP channel, in this case it will read **Disable** and the camera will appear in the list as an additional IP camera.

For IP cameras the State column will show whether the camera is **On-line** or **Off-line**.

#### Stream Settings

The Main Stream and Sub Stream columns shows the resolution, frame rate and bitrate for each camera. Some of the newer Zip cameras also support a Mobile Stream which will be displayed in the same way.

The camera's resolution, frame rate and other quality settings can be set in the [Record - Encode](#)<sup>(199)</sup> section for each stream type.

## Motion Detection And Privacy Masking

The Motion Detection and Privacy Masking columns indicates whether the camera supports either feature. To see how to configure motion detection see the [Video Menu - Motion](#)<sup>(159)</sup> section, for privacy masking see the [Video Menu - Video Cover](#)<sup>(157)</sup> section.

### 14.6.2 System Menu - Information - Record Information

The Record Info screen compiles the recording settings for each camera so you can see the quality of footage which will be captured.

Camera	Record State	Record Switch	Stream Type	Resolution	FPS	Bitrate
Cam1	ON	Enable	DualStream	1280x1944   704x480	14Fps   5Fps	2Mbps   512Kbps
Cam2	OFF	Enable	DualStream	1280x1944   704x480	14Fps   5Fps	2Mbps   512Kbps
Cam3	OFF	Enable	DualStream	1280x1944   704x480	14Fps   5Fps	2Mbps   512Kbps
Cam4	OFF	Enable	DualStream	1280x1944   704x480	14Fps   5Fps	2Mbps   512Kbps
Cam5	OFF	Enable	DualStream	1280x1944   704x480	14Fps   5Fps	2Mbps   512Kbps
Cam6	OFF	Enable	DualStream	1280x1944   704x480	14Fps   5Fps	2Mbps   512Kbps
Cam7	OFF	Enable	DualStream	1280x1944   704x480	14Fps   5Fps	2Mbps   512Kbps
Cam8	OFF	Enable	DualStream	1280x1944   704x480	14Fps   5Fps	2Mbps   512Kbps
Cam9	OFF	Enable	DualStream	1280x1944   704x480	14Fps   5Fps	2Mbps   512Kbps
Cam10	OFF	Enable	DualStream	1280x1944   704x480	14Fps   5Fps	2Mbps   512Kbps
Cam11	OFF	Enable	DualStream	1280x1944   704x480	14Fps   5Fps	2Mbps   512Kbps
Cam12	OFF	Enable	DualStream	1280x1944   704x480	14Fps   5Fps	2Mbps   512Kbps
Cam13	OFF	Enable	DualStream	1280x1944   704x480	14Fps   5Fps	2Mbps   512Kbps
Cam14	OFF	Enable	DualStream	1280x1944   704x480	14Fps   5Fps	2Mbps   512Kbps
Cam15	OFF	Enable	DualStream	1280x1944   704x480	14Fps   5Fps	2Mbps   512Kbps
Cam16	OFF	Enable	DualStream	1280x1944   704x480	14Fps   5Fps	2Mbps   512Kbps

#### Camera

The Camera column shows the channel number of the recorder.

#### Record State

The Record State column shows whether the channel is currently recording or not. You can create recording schedules in the [Record - Record Schedule](#)<sup>(211)</sup> section or trigger recordings from an event as shown in the [Alarm Menu](#)<sup>(218)</sup>.

#### Record Switch

This shows if recording is enabled for the camera or not. You can enable or disable recording for each camera as shown in the [Record - Record](#)<sup>(209)</sup> section.

## Stream Type

This shows which stream is being recorded, just the Mainstream or Dualstream (both the mainstream and the substream). You can set which streams are recorded in the [Record - Record<sup>\(209\)</sup>](#) section.

## Resolution

The Resolution column shows the resolution of mainstream and substream, as set in the [Record - Encode<sup>\(199\)</sup>](#) section, for each camera.

## FPS

The FPS (Frames Per Second) column shows the frame rate of mainstream and substream, as set in the [Record - Encode<sup>\(199\)</sup>](#) section, for each camera.

## Bitrate

The Bitrate column shows the bitrate of mainstream and substream, as set in the [Record - Encode<sup>\(199\)</sup>](#) section, for each camera.

### 14.6.3 System Menu - Information - Network State

The Network State screen displays all of the recorder's network settings in one place so you can check everything is as it should be an fault find.

Attribute	Value
WAN	
IP Address	192.168.0.241
Subnet Mask	255.255.255.0
Gateway	192.168.0.16
MAC Address	38-B1-9E-B0-03-96
IPv6 Address	2000::1 / 64
IPv6 Gateway	2000::1
DHCP	Disable
DNS1	192.168.0.8
DNS2	8.8.8.8
PPPoE	Disable
UPNP	Disable
Port	
Web	80,80,Inactive,Disable
Client	8240,8240,Inactive,Disable
RTSP	1240,1240,Inactive,Disable
Https	443,443,Inactive,Disable
Total Band Width:	32Mbps
Used Band Width:	29.75Mbps
DDNS Enable	YES

The recorder's network settings can be configured in the [Network Menu](#) <sup>(241)</sup>.

## Common Interfaces

When using your Zip recorder you will quickly get accustomed with the following interfaces. To make things as easy as possible we have used variations of these common interfaces throughout the recorder's menu system.

### 15.1 Backup

Whenever you go to save a file or multiple files to a USB backup device you will see a variation of the following screen. The Backup/Save screen can be navigated and controlled as explained below.

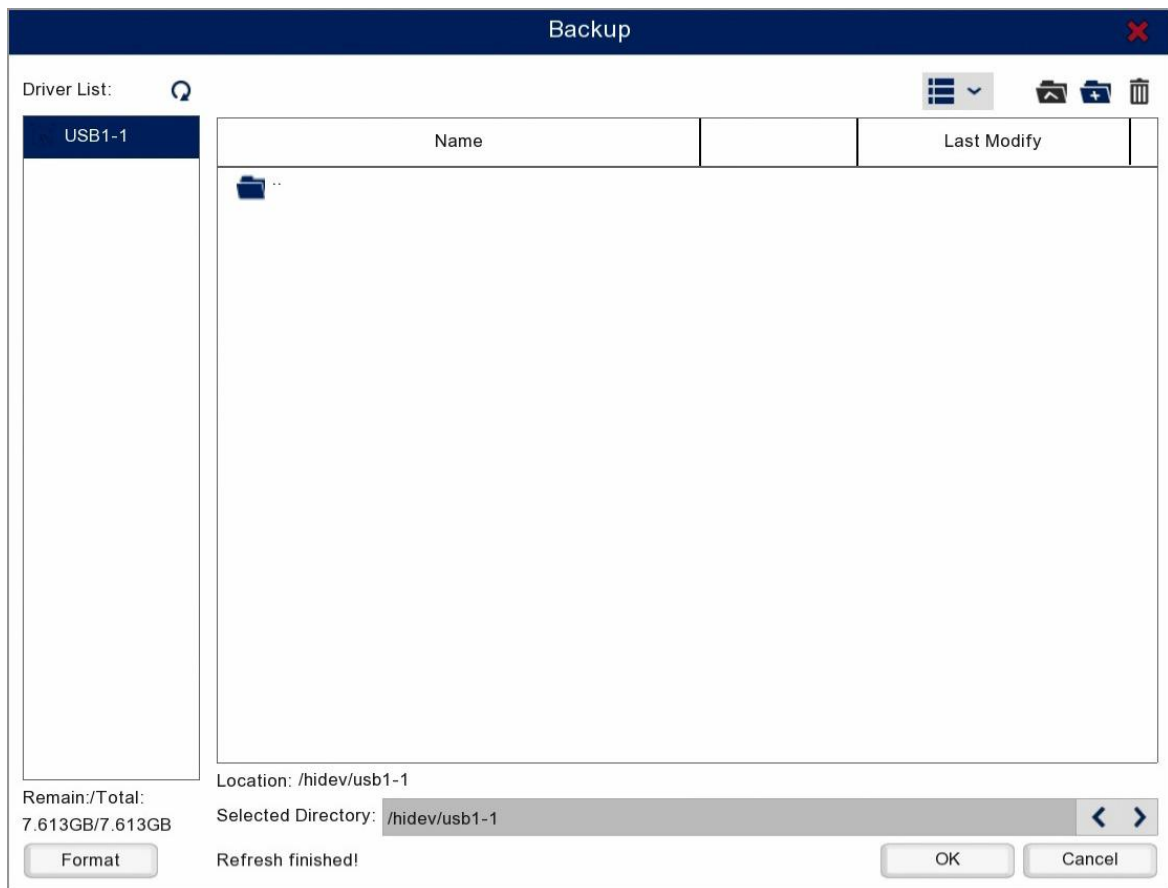

Icon	Name	Function
	<b>Refresh</b>	Refresh the USB device list to find newly connected devices.
	<b>List View</b>	Display the files on the USB device as a list.
	<b>Icon View</b>	Display the files on the USB device as large icons.
	<b>Previous Folder</b>	Go back up one level to the previous folder.
	<b>Create Folder</b>	Create a new folder inside current folder.
	<b>Delete</b>	Delete selected file or folder.
	<b>Format</b>	Erase all data on the USB backup device.
	<b>OK</b>	Click to save the file to folder you're currently inside on the USB device.
	<b>Cancel</b>	Click to exit the Backup Device screen without saving the file to the USB device.

### Drive List

The left hand panel shows the USB backup devices currently connected to the recorder. If you have a USB device plugged in to the recorder and it doesn't appear in the device list you can press the Refresh icon to reload the list of connected USB devices.

### Available Storage Space



In the bottom left corner of the Backup Device window you can see the Remaining and Total storage space available.

The **Remain** value shows how much storage space is left on the USB device for backing up files and will change as you save or delete files.

The **Total** value shows the total usable storage space available on the USB device.



## 15.2 Parameter Copy

Whenever you go to copy parameters from one camera to another you will see a variation of the following screen. This is a great time saver as you can configure one camera then quickly copy the settings to others as explained below:

The screenshot shows a 'Parameter Copy' dialog box. It features a 'Source Channel' dropdown menu currently set to 'Cam1'. Below this is a 'Parameter Type' section with a 'Select All' checkbox and several individual checkboxes for parameters: Buzzer, Alarm Out, Latch Time, Record, Post Recording, Show Message, Send Email, FTP Picture Upload, FTP Video Upload, Picture to Cloud, and Full Screen. The 'Target Channel' section has a 'Select All' checkbox and a grid of checkboxes for various cameras: Cam1 (unchecked), Cam2-Cam10 (checked), Cam11-Cam16 (checked), W Cam1, W Cam2 (checked), IP Cam1-IP Cam5 (checked). At the bottom right are 'Copy' and 'Cancel' buttons.

### Source Channel

the first thing to do when copying settings is to choose the camera you want to copy the settings from. Use the drop down list to select your source camera.

### Parameter Type

Once you have selected your source camera you need to decide which settings you want to copy.

You can select or de-select all parameter types by ticking and unticking the **Select All** check box.

Alternatively you can choose a combination of parameters by selecting the check box next to each parameter type.

### Target Channel

When you have selected which parameters you want to copy you can then choose which cameras to copy the settings to. This will overwrite the cameras current settings with the settings from the Source Channel.

You can select or de-select all Target Channels by ticking and unticking the **Select All** check box.

Alternatively you can specify which camera(s) you want to copy the settings to by ticking a combination of check boxes for the other channels on the recorder.

### Copy Settings

Once you are ready you can click the **Copy** button to copy all selected Parameter Types from the Source Channel to the Target Channel(s).

### Cancel

To exit the window without copying any settings click the **Cancel** button.

## Shutdown

There are 3 options available when you enter the Shutdown menu on your recorder, Shutdown, Reboot and Lock Screen.

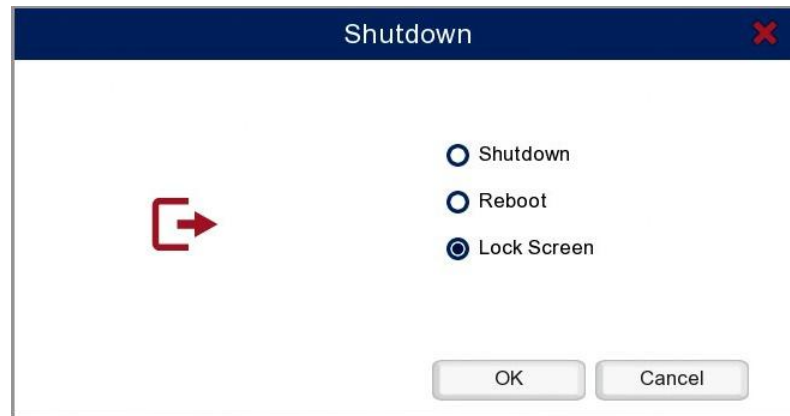

### Shutting Down The Recorder

Selecting the Shutdown option will turn the recorder off. The recorder will not capture footage when shutdown so you should only do this when it is absolutely necessary.

### Rebooting The Recorder

When you select the Reboot option the recorder will shutdown and restart automatically. You would usually do this to fix any technical errors you may be having just as you would when you restart your computer. You can schedule reboots to ensure every thing is working as it should be as shown in the [Auto Reboot](#)<sup>(303)</sup> section.

### Logging Out Of A User Account

Selecting the Lock Screen option will log you out of the recorder so when the next person comes to use it they would have to log in before they can perform any actions. This is handy if the recorder is in an area where other people, besides the operator, could get access.

### Confirming Selection

Once you have made your selection click the **OK** button to confirm. If you want to exit the Shutdown screen click the **Cancel** button.

## How To

Zip recorders have built-in help guides to walk you through some of key settings you may need to configure and some of the common actions you may wish to perform.

Each guide will have a website address and QR code so you can access the full tips and guides online on our website.

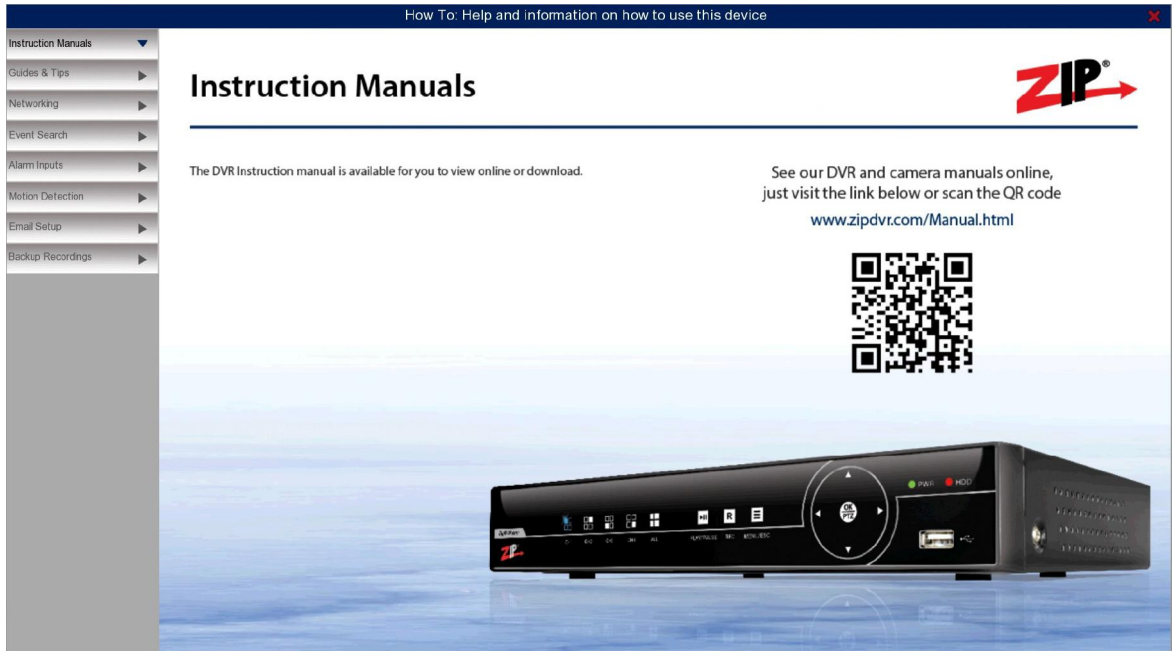

We have also included solutions to commonly asked "How To" questions in this manual to help you if you get stuck.

## 17.1 Setup Email

Zip recorders support SMTP email setup.

This is typically an internet based mail server which the recorder logs into to send email notifications, motion detection or errors.

Be aware that when using public or internet connected servers username and password authentication will be required.

Here are two examples for SMTP setup:

- [Gmail](#) <sup>323</sup>
- [Yahoo](#) <sup>326</sup>

### 17.1.1 Setup Email - Gmail

To create your GMail account go to [google.com](http://google.com) click on 'GMail' and then 'Create an account' and follow the on screen instructions or alternatively use an existing GMail account.

If you share one email account between multiple devices all of the emails will be visible in the sent folder.

One account can be used for both sending and receiving the emails.

Google are now deprecating the use of the Less Secure Apps Setting on Gmail accounts.

Although this method is available and can be turned on in [myaccount.google.com/security](https://myaccount.google.com/security) its is not recommended for security reasons. The more secure way, and recommended by google, is to use app passwords these passwords can only be used by a single device. In order to use this feature Google requires the account to have 2 step verification turned on.

#### Turning on 2 Step Verification.

1. In your browser go to [myaccount.google.com/security](https://myaccount.google.com/security) You can also navigate to here through Settings > Security.
2. Under 'Signing in to Google' turn on 2 Step Verification and follow the instructions.

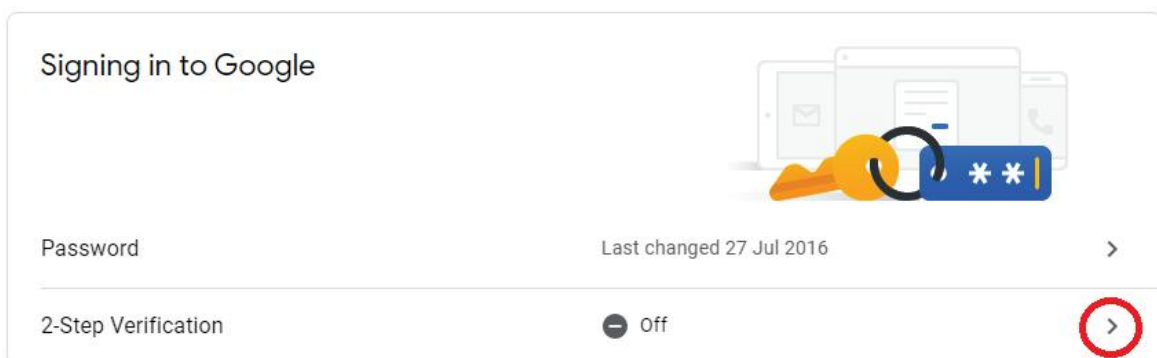

#### Creating an App Password

1. If you have 2 step verification switched on go to Settings > Security (<https://myaccount.google.com/security>).
2. Under Signing in to Google – App passwords click on the right arrow and log in to your

account.

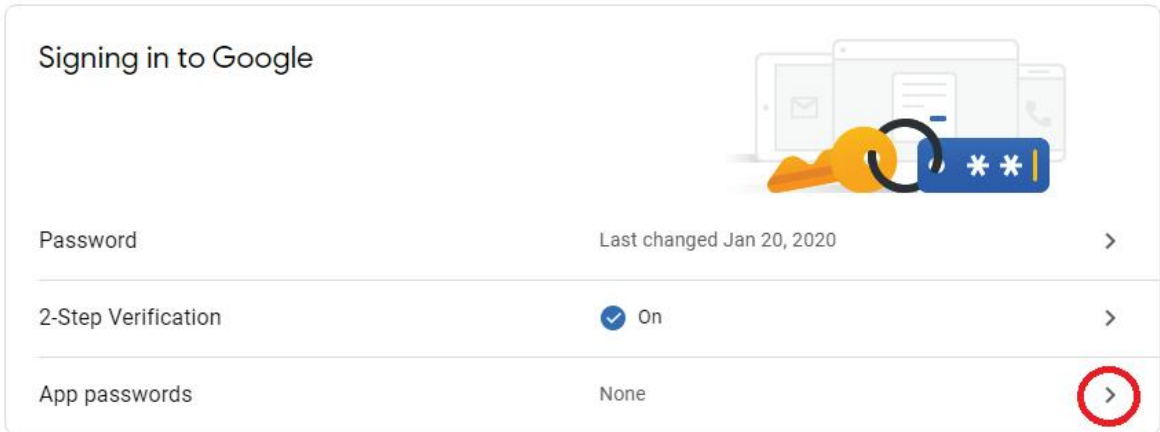

3. Click on Select app and Other (Custom Name)

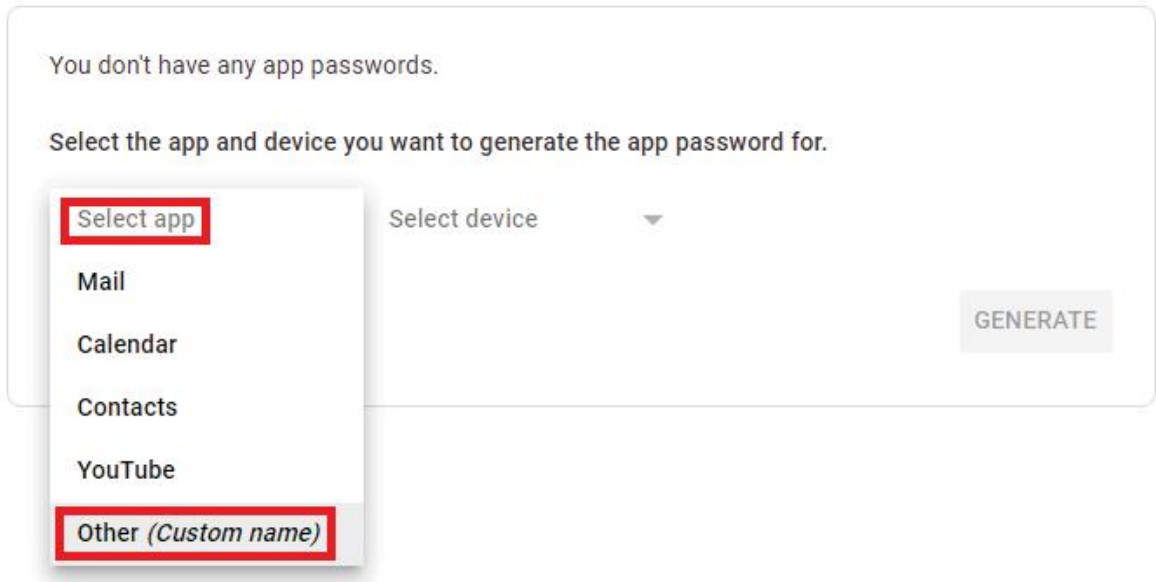

4. Enter a name for your device and click Generate.

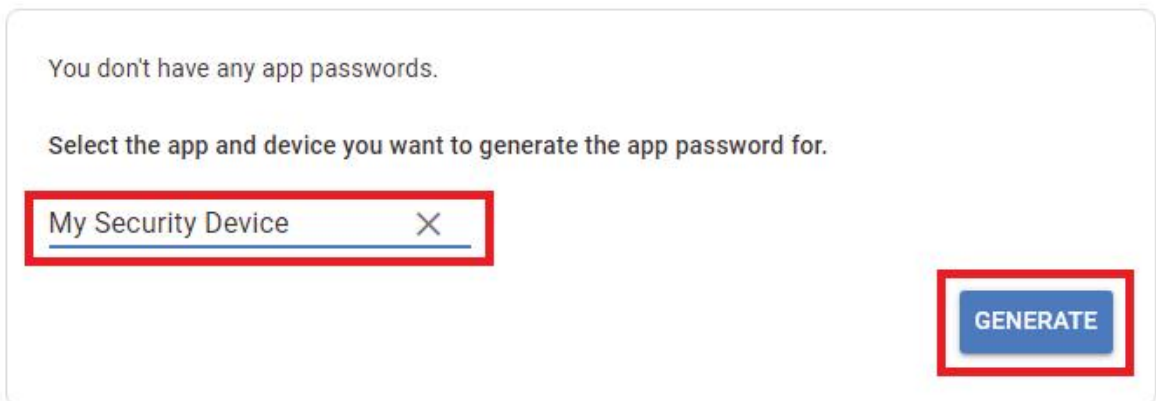

5. You will now see the generated app password that you need to enter into you device. When you click Done you will not be able to see the password again.

### Generated app password

Your app password for your device

inmp htkm naor bhcl

#### How to use it

Go to the settings for your Google Account in the application or device you are trying to set up. Replace your password with the 16-character password shown above.

Just like your normal password, this app password grants complete access to your Google Account. You won't need to remember it, so don't write it down or share it with anyone.

**DONE**

6. Enter details in to your DVR\NVR or Camera.

Typical email settings will require the following details :-

**Encryption** – Auto or TLS for ports 25 and 587, SSL for port 465.

**Port** – 25, 587 or 465. Check encryption above.

**SMTP Server** – smtp.gmail.com

**Username** – Gmail Username.

**Password** – App password just created not the GMail account password. Enter the 16 digit password without spaces.

**Sender** – Used to identify the sending device. This appears as From: in the received email.

**Receiver** – The receivers email address. Some devices allow more than one receiver.

Encryption	TLS
SMTP Port	00587
SMTP Server	smtp.gmail.com
Username	testing@gmail.com
Password	ursxbnjeukjtr
Sender	testing
Receiver 1	testing@gmail.com

### 17.1.2 Setup Email - Yahoo

Go to [uk.yahoo.com](http://uk.yahoo.com) and click on 'Sign in' and then 'Create an account'. Follow the instructions to create your account or alternatively use an existing account.

If you share one email account between multiple devices all of the emails will be visible in the sent folder.

One account can be used for both sending and receiving the emails.

Once you have a Yahoo! Mail account you will need to create an app password for your device.

You cannot use the account password and every device will need its own app password.

1. Go to <https://login.yahoo.com/account/security> you will be prompted to sign in with your account details if you are not already signed in.

2. Click on 'Generate app password'.

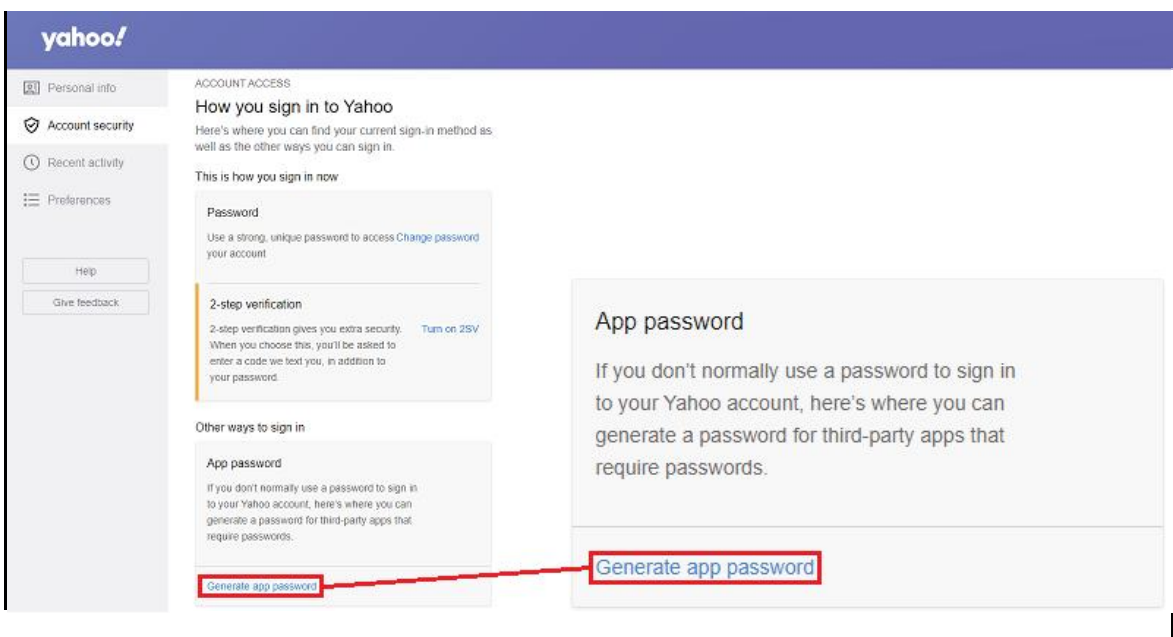



3. Enter a name for your device and click Generate password.

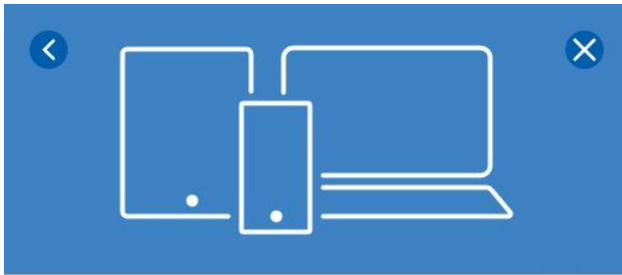

### Generate an app password

Some apps require a separate, single-use password to sign in. Generate and manage them here.

Enter your app's name

My Security Device

Generate password

4. Make a note of the password and enter it into your device. Once you click Done you will not be able to see this password again.

You can delete and create another password if necessary.



### Your app password

Your single-use app password for **My Security Device** is:

jvki rwpq rcji grvh

Copy

This is a single-use password. You do not need to remember it. It does not replace your normal password.

#### How to use this password

1. Sign in to the app/service using your normal username
2. Instead of your normal password, enter the app password above

If you stop using **My Security Device**, you can delete the app password here to remove **My Security Device**'s access to your account.

Done

5. Enter details in to your DVR\NVR or Camera.

Typical email settings will require the following details :-

**Encryption** – Auto or TLS for ports 25 and 587, SSL for port 465.

**Port** – 25, 587 or 465. Check encryption above.

**SMTP Server** – smtp.mail.yahoo.com

**Username** – Yahoo! Username.

**Password** – App password just created not the GMail account password. Enter the 16 digit password without spaces.

**Sender** – Used to identify the sending device. This appears as From: in the received email.

**Receiver** – The receivers email address. Some devices allow more than one receiver.

Encryption	Auto
SMTP Port	00025
SMTP Server	smtp.mail.yahoo.com
Username	systest@yahoo.co.uk
Password	pdfjhzmtcpzrydk
Sender	ZIP216 Sample Test Email
Receiver 1	systest@yahoo.co.uk

## 17.2 Recover Forgotten Password

If you forget your password you can click **Forgot Password** on the login interface and a super-password will be emailed to you if an email address has been setup prior. See [Email Settings](#)<sup>252</sup>.



If you do not have an email address setup, please contact your installer for help with resetting the password. You will need the system date which is displayed at the top of the screen during live view and the device's serial number. The serial number is 8 digits long made up of 3 letters followed by 5 numbers. This can be found on the barcode label on the recorder or by selecting **Info** in the Live View menu (right click). In the Info menu look for the **P2P ID**. The serial number is the **last 8 digits** of the P2P ID code.



### Default Password

The default user for the Zip recorder is **admin** and the default password is **555555**.

## Useful Links

You can find lots of useful information, videos and tools on our website [www.ZipNVR.com](http://www.ZipNVR.com).

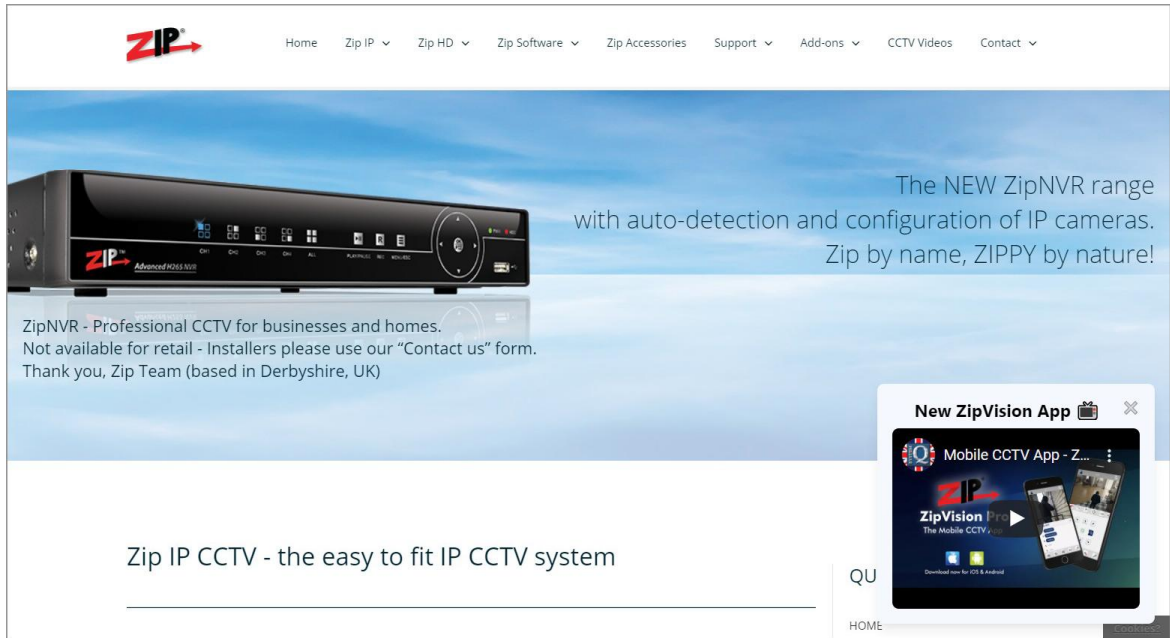

### Tips & FAQs

We have a wide selection of tips and FAQs available at:

[www.zipnvr.com/FAQ.html](http://www.zipnvr.com/FAQ.html)

### Manuals

You'll find manuals for our Zip recorders and cameras here:

[www.zipnvr.com/Manual.html](http://www.zipnvr.com/Manual.html)

### Free Tools

We have created some neat CCTV tools to help you out:

[www.zipnvr.com/Tools.html](http://www.zipnvr.com/Tools.html)

### Warranty Registration

Register your recorder within 90 days of purchase for a Free £30 gift:

[www.zipnvr.com/Warranty.html](http://www.zipnvr.com/Warranty.html)

### Software Registration

Register your Zip Vision software to confirm its use is authorised:

[www.zipnvr.com/software.html](http://www.zipnvr.com/software.html)

### CCTV Videos

We have videos covering Zip and other great CCTV products at:

[videos.softcctv.com](http://videos.softcctv.com)

### Mailing List

Subscribe to our mailing list for news on all our latest CCTV products:

[www.zipnvr.com/signup.html](http://www.zipnvr.com/signup.html)

### Contact Us

You can get in touch with us if you have any queries as:

[www.zipnvr.com/contact.html](http://www.zipnvr.com/contact.html)

## Software & Apps

You'll find a wide range of Zip software to help you get the most out of your Zip CCTV system at [SoftCCTV.com](http://SoftCCTV.com).



### [ZipVision - Zip DVR & NVR Client Software](#)

Modern, slick and easy to use are the best ways to describe the Zip's client software ZipVision.



### [Android App - Zip](#)

Android Compatible Phone App for easy viewing of your Zip CCTV footage on your mobile phone.



### [iOS App - Zip](#)

iPhone Compatible Phone App for easy viewing of your Zip CCTV footage on your mobile phone.



**Zip Finder - IP Camera Discovery Tool**

Zip Finder is a great tool for managing your IP cameras. It quickly finds and displays all of your Zip IP cameras on the network.

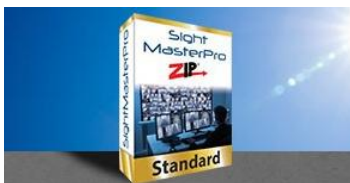

**SightMaster - Standard Module for ZipNVR/DVRs**

Multi-site management of CCTV with live playback, viewing and local download facility. ZipDVR and NVR compatible.

**Zippy Player - ZIP Single Channel Edition**

A convenient CCTV evidence player that will play any of the footage files when dropped into a folder. Compatible with Zip branded NVRs, DVRs and IP cameras.



**goGet CCTV - Zip Download Tool**

Handy little download program, useful for the bulk downloading of CCTV footage. Compatible with most Zip DVRs and NVRs.

**CCTV Viewing Widget - Zip**

The simplest way to view footage from your Zip Recorder, ideal to give to staff or temporary users access to a camera image without allowing full access to the client software.



**Extra Licences (5x ZipVision)**

If you've used up all your ZipVision software licences and wish to add more, please purchase this package. Includes 5 licences.



## Troubleshooting

We have created the Zip recorders to be as intuitive and user friendly as possible. Hopefully this manual will help you understand your recorder and get the most out of it. However, there still might be times where you come across an issue and aren't quite sure what is causing it. We have created the following table issues you may encounter and possible solutions for you to try to rectify the problem.

Problem	Possible Cause	Possible Solution
<p><b>The system is alarming and isn't recording</b></p>	Hard drive is full	Check the hard drive state in the <a href="#">Storage - Disk</a> <sup>(266)</sup> sub-menu. If the state is <b>Full</b> you can change the overwrite action to <b>Auto</b> , this will overwrite old footage when full.
	Loose cables	Check the hard drive state in the <a href="#">Storage - Disk</a> <sup>(266)</sup> sub-menu. If there is an error the cables to the hard drive may have come loose. You can try turning off the recorder and removing the power source. Remove the recorder's case and check that the data and power cables are securely connected to both the hard drive and main board. Once checked replace the cover, reconnect the power and turn on the recorder to see if the problem persists.
	There is a hard drive error	Check the hard drive state in the <a href="#">Storage - Disk</a> <sup>(266)</sup> sub-menu. If there is an error the hard drive could have failed and may need replacing.
<p><b>I have changed the password and now I can't log in</b></p>	Forgotten password	<ol style="list-style-type: none"> <li>1. If you have emails setup click the <b>Forgot Password</b> button and a new super password will be emailed to you which can be used for 1 day only. After you use this password you should immediately set a new password.</li> <li>2. If you haven't setup emails you will need to contact your installer with system date (displayed at the top of the screen) and the recorder's serial number. This is 3 letters and 5 numbers which can be found on the barcode label or in the <a href="#">Info</a><sup>(32)</sup> screen.</li> </ol>
<p><b>I get no image from an IP camera it just says Off-line</b></p>	Incorrect IP addressing	The IP addressing on IP cameras are very specific. The IP details set in the recorder must match the those of the camera exactly. For more information see the <a href="#">IP Channels</a> <sup>(118)</sup> section.
	Faulty Cable	<ol style="list-style-type: none"> <li>1. Ensure that the correct pairs are connected to the right pins on the RJ45 connector, that the connections are sound and that the cables are in good condition.</li> <li>2. To eliminate cable issues, if the recorder has an internal switch, connect the camera direct to the</li> </ol>

Problem	Possible Cause	Possible Solution
		switch. If the recorder doesn't have a built-in switch connect it direct to a PC using a crossover cable and use the Zip Finder program, to modify the IP address and view the camera.
<b>The recorder is behaving erratically and/or cutting out</b>	Overheating	The recorder needs to dissipate heat when it is running. Install the recorder in a place with good air circulation and away from heat sources to ensure stability and life of the recorder.
<b>The remote controller doesn't work</b>	Remote isn't pointing at the recorder	Try again by aiming the remote controller at the IR receiver on the front panel of the recorder.
	Low batteries	Check that the batteries in the remote controller are not flat.
	Incorrect device ID	The Device ID by default is 000 but if it has been set to a value, then you have to enter this value to unlock the recorder. See the <a href="#">IR Remote Control</a> <sup>(28)</sup> section for more details.
<b>The hard drive is full and I want to free up space</b>	Hard drive is full	Due to file security you cannot erase individual files. If you want to erase files you have to erase everything at once by formatting the hard drive as explained in the <a href="#">Storage - Disk</a> <sup>(266)</sup> sub-menu.
<b>No footage appears in the Playback screen</b>	Recording has not been setup correctly	Ensure that you have set the required channels to record and that they are scheduled to record in <a href="#">Record</a> <sup>(209)</sup> sub-menu. Check that the record icon appears in live view mode.
	There is a hard drive error	Check the hard drive state in the <a href="#">Storage - Disk</a> <sup>(266)</sup> sub-menu. If there is an error the hard drive could have failed and may need replacing.
	Footage has been overwritten	The footage you are looking for may have already been overwritten. If the hard drive's overwrite status is set to Auto or after X days, the recorder will overwrite old footage when the hard drive is full or when the number of days has elapsed.
	Incorrect search parameters	Check that you have entered your search parameters correctly
	Incorrect date or time	The recorder's date and/or time might have been wrong in the past but has since been corrected. The footage previously recorded will still contain the incorrect date and/or time. For example if the date was out by a day, events that happened on the 5th might only appear when you search for events that happened on the 4th.



Problem	Possible Cause	Possible Solution
	Battery backup has failed	The date and time has reverted to a default setting following a power loss and the recorder's on-board battery may have failed. If so the battery will need replacing.
<b>Motion detection isn't working</b>	Motion detection isn't enabled	Check that the switch is enabled for the required cameras in the <a href="#">Video - Motion</a> <sup>(159)</sup> sub-menu.
	No motion area defined	Check that you have defined the detection area as shown in the <a href="#">Motion - Setup</a> <sup>(160)</sup> section.
	Motion detection isn't scheduled to record	<ol style="list-style-type: none"> <li>1. Check that Motion is scheduled to record for the required camera in the <a href="#">Record - Schedule</a><sup>(211)</sup> sub-menu.</li> <li>2. Check that the schedule covers the intended time period</li> </ol>
	Recording has not been setup correctly	Check that the Record Switch is enabled in the for the required channel in the <a href="#">Record</a> <sup>(209)</sup> sub-menu..
	Sensitivity has been set to low	Increase the sensitivity in the <a href="#">Video - Motion</a> <sup>(159)</sup> sub-menu.
<b>An alarm input isn't working</b>	Input connections no connected correctly	Check that you have connected the alarm connections on the back of the recorder to the correct alarm channel and ground.
	Trigger device is faulty	You can bridge the alarm and ground connections on the back of the recorder causing an alarm trigger. If this works it could mean that the trigger device is at fault.
	Incorrect alarm type	Check that the Alarm Type set in the recorder matches that of the trigger device, Normally-Open or Normally-Closed in the <a href="#">Alarm - I/O</a> <sup>(223)</sup> sub-menu.
	Wrong channel set to record	Check that you have the right channel has been set to record in the <a href="#">Alarm - I/O</a> <sup>(223)</sup> sub-menu. Enabling the Buzzer and/or Full Screen mode will allow you to see if the input is triggering correctly, if it is you know a setting in the recorder is at fault.
	PTZ isn't triggering	<ol style="list-style-type: none"> <li>1. Check that the PTZ is working correctly by testing the PTZ controls in live view mode, see the <a href="#">PTZ Controls</a><sup>(40)</sup> section.</li> <li>2. Check that the PTZ is configured properly in the <a href="#">Video - PTZ</a><sup>(155)</sup> sub-menu.</li> <li>3. Check that PTZ Linkage has been enabled and that the correct PTZ channel and preset have been enabled in the <a href="#">Alarm - PTZ Linkage</a><sup>(230)</sup> sub-menu.</li> </ol>

Problem	Possible Cause	Possible Solution
	<p>Alarm isn't scheduled to record</p>	<ol style="list-style-type: none"> <li>1. Check that Alarm is scheduled to record for the required camera in the <a href="#">Record - Schedule</a><sup>(211)</sup> sub-menu.</li> <li>2. Check that the schedule covers the intended time period</li> </ol>

## Conditions

All specifications are approximate. System Q Ltd reserves the right to change any product specifications or features without notice. Whilst every effort is made to ensure that these instructions are complete and accurate, System Q Ltd cannot be held responsible in any way for any losses, no matter how they arise, from errors or omissions in these instructions, or the performance or non-performance of the equipment that these instructions refer to.



This symbol on the products and/or accompanying documents means that used electronic equipment must not be mixed with general household waste. For treatment, recovery and recycling please return this unit to your trade supplier or local designated WEE/CG0783SS collection point as defined by your local council.

© Copyright 2022

Zip is a registered trademark of System Q Ltd, Chesterfield, Derbyshire, S40 2WB



# Index

## - 0 -

0 Channel 277

## - 3 -

3G Settings 50

## - A -

Activity Log 297  
 Adding Cameras From An Alien DVR 140  
 Adding Cameras From Zip Recorders 135, 138, 140  
 Adding IP Cameras 123, 131, 133, 142  
 Adding Tags 39, 48, 71  
 Address 155  
 Admin Name 22, 290  
 Admin Password 22, 290  
 AI 163, 164, 167, 168, 171, 172, 175, 176, 180, 181, 186, 187, 190, 191, 193, 195, 197, 226  
 Alarm 223, 239  
 Alarm Handling 220, 226, 230  
 Alarm Menu 218  
 Alarm Trigger 34  
 Alerts 233, 237  
 Allow List 262  
 Analysis 197, 268  
 Android App 331  
 App Settings 56  
 Audio 190, 191  
 Auto Assign IP 123  
 Auto Focus 41  
 Auto Reboot 303  
 Auto Switch 32, 283, 285  
 Automatic PTZ Movement 230  
 Automatic Uploads 257

## - B -

Backlight Compensation 151  
 Backup 69, 75, 81, 317  
 Band Width 142  
 Battery Powered Cameras 115  
 Baudrate 155, 295  
 Bitrate 199, 203, 206

Black List 262  
 Block List 262  
 Blue Disc Menu 112  
 BNC Spot Monitor Output 282, 285  
 Brightness 39, 47, 149

## - C -

Call Presets 43  
 Camera Menus 151  
 Camera Name 63, 147, 149  
 Camera Settings 151, 308  
 Camera Status 61  
 Capture 213, 216  
 Car 175, 176  
 CC 186, 187, 197  
 Channel Information 35, 312  
 Channel Layout 59, 62  
 Channel Name 147, 149  
 Channel Status 61  
 Clipping Tool 69  
 Cloud Storage 270  
 Colour Settings 39, 47  
 Configuration 302, 308  
 Connecting A USB Device 99  
 Connecting IP Cameras 119  
 Connections 6, 8, 10, 13, 15, 17, 19  
 Contact Us 330  
 Contrast 39, 47, 149  
 Controls 7, 9, 11, 14, 16, 18, 20, 28, 30, 39, 65  
 Copy 319  
 Copyright 337  
 Count 186, 187, 197  
 Counting 186, 187, 197  
 Cover 193  
 Covered 193  
 Covert Recording 147, 149  
 Create Presets 43  
 Cross 186, 187, 197  
 Crossing 167, 168, 186, 187, 197  
 Cruise 43  
 Custom Protocols 145  
 Customised Tags 48, 71

## - D -

Data Bit 295  
 Date 279  
 Date & Time 53, 149  
 Daylight Saving Time 279

Daylight Savings 53  
 DDNS 250  
 Default Password 129, 329  
 Default Settings 300  
 Default Username 329  
 Deleting IP Cameras 142  
 Detection 163, 164, 167, 168, 171, 172, 175, 176, 180, 181, 186, 187, 190, 191, 193, 197  
 Detection Area 90, 160  
 Device ID 275  
 Device Name 275  
 DHCP 50, 243  
 Diagnostic 268  
 Digital Zoom 39, 46, 68  
 Disc Menu 112  
 Disk Drives 25, 55, 266  
 Display Options 59  
 DNS Settings 50, 243  
 Drives 25, 55  
 DropBox 270  
 DST 53, 279  
 DVR Name 275  
 DWDR 151  
 Dynamic DNS 250

## - E -

Email 252, 255, 323, 326  
 Encoding 199, 203, 206  
 Error 233, 237  
 Events 297  
 Exceptions 233, 237  
 Export 317  
 Export Settings 302, 308  
 External File Playback 99  
 Extra Licences 331

## - F -

Face 180, 181  
 Facial 180, 181  
 Factory Settings 300  
 Fault Finding 333  
 Finding IP Cameras 125  
 Firmware 35  
 Firmware Upgrade 301, 305, 306  
 Firmware Version 310  
 Flow 186, 187, 197  
 Flow Control 295  
 Focus 40, 41

Footage 64  
 Footfall 186, 187, 197  
 Forgotten Password 329  
 Format 275  
 Formatting Hard Drives 55, 266  
 FPS 199, 203, 206  
 Frame Rate 199, 203, 206  
 Front Panel 7, 9, 11, 14, 16, 18, 20  
 FTP 257, 260

## - G -

Gateway 243  
 GDPR 266  
 General Playback 72  
 Gmail 323  
 Google 323  
 Google Drive 270  
 Guidelines 4  
 Guides 322

## - H -

Hard Drive 25, 55, 233, 237, 266, 268  
 HDD 25, 55  
 HDMI Video Output 282, 283  
 How To 322  
 Hue 39, 47, 149

## - I -

I/O 223  
 Icons 61  
 Image Settings 149  
 Information 35, 310, 312  
 Input 223  
 Installation 22, 25  
 Instant Detective 86, 90  
 Intelligent 163, 164, 167, 168, 171, 172, 175, 176, 180, 181, 186, 187, 190, 191, 193, 195, 197, 226  
 Introduction 1  
 Intrusion 163, 164  
 iOS App 331  
 IP Address 127, 142, 243, 262  
 IP Camera Maintenance 304  
 IP Camera Password 129  
 IP Cameras 118, 119, 123, 125, 127, 131, 133, 135, 138, 140, 142  
 IP Channels 118  
 IP Filter 262

IR LEDs 151  
 IR Remote Control 28  
 Iris 41

## - K -

Keyboard 31

## - L -

Layout Options 59  
 LCD 167, 168  
 Lens Covered 193  
 Line Crossing 167, 168  
 Live View 32, 34, 35, 39, 59, 63  
 Live View Display 59, 62  
 Live View Icons 61  
 Load Settings 302, 308  
 Local Connection Settings 50, 243  
 Lock Footage 75  
 Lock Screen 321  
 Log 297  
 Log Out 321  
 Loitering 171, 172, 175, 176

## - M -

Main Menu 112  
 Mainstream 35, 199, 209  
 Maintenance 233, 237, 297  
 Manual Alarm 34  
 Manual Capture 101  
 Manual Record 34, 39  
 Manual Snapshot 39  
 Manuals 330  
 Menu 32, 112  
 Menu Timeout 275  
 Menu Transparency 283  
 Mobile Settings 56  
 Mobilestream 206  
 Models 4  
 Motion Detection 86, 159, 160, 220, 230  
 Mouse 30  
 Mouse Cursor 283  
 Mouse Speed 283  
 Movement Detection 159, 160, 220, 230  
 Multi Channel 277

## - N -

Name 275  
 Network Information 35  
 Network Menu 241  
 Network State 316  
 Networking 50, 243, 245  
 Noise 190, 191  
 Non-PoE NVR 5  
 Notifications 233, 237  
 NTP 53, 279

## - O -

Obscured 193  
 Online Storage 270  
 On-screen Keyboard 31  
 Operation 27  
 Options 32  
 OSD 63  
 Output 223  
 Output Resolution 56, 283  
 Overlay 63  
 Overview 1  
 Overwriting 55, 266

## - P -

P2P 58, 247  
 Pairing Wireless Cameras 115  
 Parameter Copy 319  
 Parity 295  
 Password 22, 129, 290, 329  
 Password Recovery 252  
 Passwords 288  
 PD 175, 176  
 Pedestrian 175, 176  
 Perimeter 163, 164  
 Permissions 288, 293  
 Person 175, 176, 180, 181  
 Phone App 331  
 Picture Playback 101, 105  
 Picture Preview 105  
 PID 163, 164  
 Plan 211, 216, 239, 255, 260  
 Playback 32, 64, 65, 72, 83, 86, 93, 96, 99, 101, 105, 107, 110  
 Player 64, 331  
 PoE 119

PoE NVR 12  
 Port Forwarding 50, 247  
 Power 26  
 Power Down 321  
 PPPoE 50, 245  
 Pre-record 209  
 Presets 40, 43  
 Preview 81  
 Privacy Masking 157  
 Protocol 145, 155  
 PSU 26  
 PTZ 230  
 PTZ Controls 39, 40, 41  
 PTZ Cruise 43  
 PTZ Linkage 230  
 PTZ Settings 155  
 PTZ Tour 43

## - Q -

Quality 199

## - R -

Rapid Deploy Cameras 115  
 Realtime 59  
 Rear Panel 6, 8, 10, 13, 15, 17, 19  
 Reboot 303, 307, 321  
 Record Information 314  
 Record Menu 198  
 Record Settings 35  
 Recording 34, 39, 199, 209, 211  
 Refresh Rate 147  
 Registration 330  
 Relay 34  
 Remote Control 28  
 Remote Monitoring 56, 58, 247, 250  
 Removing A Detection Area 90  
 Removing IP Cameras 142  
 Report 197, 268  
 Resetting Password 329  
 Resolution 56, 199, 203, 206  
 Restart 321  
 Retrospective 86  
 Review 64  
 RS485 295  
 RTSP 145, 247

## - S -

S.M.A.R.T 268  
 Safety Information 4  
 Saturation 39, 47, 149  
 Save 317  
 Save Settings 302, 308  
 Saving Footage 75, 81  
 Schedule 191, 195, 211, 216, 239, 255, 260  
 Scheduled Reboot 303  
 Screen Position 283  
 Screen Size 283  
 Serial Number 310  
 Setting A Detection Area 90  
 Settings 302  
 Setup 22, 49  
 Shutdown 321  
 Shutter Speed 151  
 Simultaneous Playback 83  
 Slice Playback 107, 110  
 Smart 163, 164, 167, 168, 171, 172, 175, 176, 180, 181, 186, 187, 190, 191, 193, 195, 197, 226  
 Smart Setup 275  
 SMTP 252, 323, 326  
 Snapshots 39, 101, 105, 213, 216  
 Snipping Tool 69  
 SOD 171, 172  
 Software Registration 330  
 Sound 190, 191  
 Specification 3  
 Spot Monitor Output 282, 285  
 Startup Wizard 49  
 Stationary Object 171, 172  
 Status 61  
 Still Images 213, 216  
 Stop Bit 295  
 Storage 25, 266  
 Storage Menu 265  
 Stream 199, 203, 206  
 Subnet Mask 243  
 Sub-Periods 83  
 Substream 35, 203, 209  
 System Information 35  
 System menu 273

## - T -

Tag Playback 93, 96  
 Tags 39, 48, 71, 93, 96



Tally 186, 187, 197  
Technical Specification 3  
Test 268  
Time 279  
Time & Date 53, 147, 149  
Timetable 211, 216, 239, 255, 260  
Tips 322  
Toolbar 39, 65  
Traffic 186, 187, 197  
Transparency 283  
Trigger 223  
Troubleshooting 333

## - U -

Unlock Code 22, 290  
Update 301, 305, 306  
Upgrade 301, 305, 306  
Uploading 257  
UPnP 50  
USB Mouse 30  
USB Playback 99  
User Accounts 288, 290, 293  
User Permissions 293  
Username 22, 129, 290, 329

## - V -

Vehicle 175, 176  
VGA Video Output 282, 283  
Video 199  
Video Cover 157  
Video Encoding 199  
Video Format 275  
Video Loss 233  
Video Menu 113  
Video Player 64  
Video Quality 199, 203, 206  
Video Settings 199, 203, 206  
Video Sub-menu 114  
Video Tags 71, 93, 96  
Virtual Keyboard 31  
Volume 32

## - W -

Warranty Registration 330  
WDR 151  
White List 262  
Wireless Cameras 115

Wizard 275

## - Y -

Yahoo 326

## - Z -

Zip Channel 277  
Zip Finder 331  
Zip IP Cameras 123  
Zip Non-PoE NVR 5  
Zip PoE NVR 12  
Zip Vision 58, 331  
ZIP104 6, 7  
ZIP108 8, 9  
ZIP116 10, 11  
ZIP204 13, 14  
ZIP208 15, 16  
ZIP216 17, 18  
ZIP226 19, 20  
Zippy Player 331  
Zoom 39, 40, 41, 46, 68