

Installation and Operation Manual

Models covered

CCT734 – 4 Channel DVR
CCT735 – 8 Channel DVR
CCT736 – 16 Channel DVR



INSTALLATION & SAFEGUARDS

All the safety and operating instructions should be read before the unit is operated.

Environment Condition for Installation

- To prevent electric shock or other hazard, do not expose units to rain, moisture, or dust.
- This unit should be located in an area with low humidity and a minimum of dust.
- Place this unit in a well-ventilated place and do not place heat-generating objects on this unit.
- This unit should not be located in an area where it is likely to be subjected to mechanical shocks.

Before You Start

- Ensure the power switch is in the OFF position prior to starting.
- Do not attempt to service this unit yourself as opening or removing covers may expose you to dangerous voltage or other hazards.
- Installation should be performed by qualified service personnel only.
- This unit should be operated only from the type of power source indicated on the manufacturer's label and with the power supply included with the unit.

Notice

- Before initial configuration or operation you must first set the TIME/DATE, followed by setting the unit to the FACTORY DEFAULT settings, lastly clearing the HDD. Please follow these steps in order.
- Before installing a second HDD, ensure that the drive conforms to the specifications listed on the specifications page at the end of this manual. When installing a second HDD, set the drive to SLAVE. After installation, first reset the TIME/DATE, followed by resetting the unit to the FACTORY DEFAULT settings, lastly clearing the new HDD.
- Pull the unit out of record mode prior to cutting power to the unit. Do this by entering the setup menu, followed by switching the unit off. Powering off the unit while writing to the disks can cause critical malfunctions. (Ex: Recording Error, Playback Error, System Error).
- When you set the record type, you have to set the Record Configuration and also Schedule Setup. This unit records as per the Record type & Schedule setup.
- The [REC] button on the front panel is for emergency record using highest image quality.



The lightning flash with arrowhead symbol within an equilateral triangle is intended to alert the user of this equipment that there are dangerous voltages within the enclosure which may be of sufficient magnitude to constitute a risk of electric shock.



The exclamation point within an equilateral triangle is intended to alert the user to presence of important operating and maintenance (Servicing) instructions in the literature accompanying the appliance.

Contents

Chap.1	Features & Package Contents	-----	3
1-1.	Features	-----	3
1-2.	Package Contents	-----	4
Chap. 2	Function of Each Button	-----	5
2-1.	Front	-----	5
2-2.	Rear	-----	7
Chap. 3	Installation	-----	8
3-1.	Installation Configuration	-----	8
3-2.	Detailed Installation	-----	9
1)	HDD(Hard Disk Drive)	-----	9
2)	Camera	-----	10
3)	Monitor	-----	10
4)	Power	-----	10
5)	VCR, Video Printer	-----	11
6)	Other External Device	-----	11
7)	Connector Pin Assignment	-----	12
8)	RS-232C ASCII-code	-----	12
Chap. 4	Operation	-----	13
4-1.	Start-up DVR	-----	13
4-2.	System Log-in	-----	13
4-3.	Factory Default	-----	14
4-4.	Display Configuration	-----	14
4-5.	Live View Setup	-----	15
1)	Full / Multiple View	-----	15
2)	Sequencing Cameras	-----	15
3)	PIP View	-----	15
4)	Freeze View	-----	15
5)	Zoom View	-----	15
4-6.	Record	-----	16
4-7.	Playback	-----	16
4-8.	Search	-----	17
4-9.	PTZ Camera Operation	-----	18
4-10.	Data Back-Up	-----	18

Chap.5	Set Up	-----	19
5-1.	Entering the Menu	-----	19
5-2.	Display Setup	-----	20
1)	Screen Display	-----	20
2)	Monitor Setup	-----	20
5-3.	Configuration	-----	21
1.	HDD Management	-----	21
2.	TIME/DATE Setup	-----	22
3.	Camera Setup	-----	22
4.	Interval Setup	-----	24
5.	Alarm Setup	-----	24
6.	Buzzer Setup	-----	25
7.	Password Setup	-----	25
8.	System Information	-----	25
5-4.	Record Setup	-----	26
1.	Record Configuration	-----	26
2.	Schedule Setup	-----	27
3.	Holiday Setup	-----	27
5-5.	Back-Up	-----	28
5-6.	External Device	-----	28
1.	TCP/IP Setup	-----	29
2.	RS-232C Setup	-----	29
3.	Pan Tilt Zoom Setup	-----	29
5-7.	FACTORY Default	-----	30
5-8.	Language Setup	-----	30
CHAP. 6	Network Setup	-----	31
6-1.	DVR Network Configuration	-----	31
6-2.	Remote Viewer Program	-----	33
6-3.	Back-Up CD Player	-----	39
6-4.	DDNS	-----	41
6-5.	FAQ	-----	45
CHAP. 7	Specifications	-----	51

CHAP. 1 Features & Package Contents

1-1. Features

Live View

Real time display per camera
Auto Sequence
PIP (Picture in picture)
Digital Zoom
Display Freeze
Simple Playback mode
Simple PTZ camera control

Record

Variable Record resolution (For higher picture quality or higher recording speed)
Efficient Image Quality setup in 5 steps
Schedule Record / Holiday Record
Event Record (Alarm / Motion)
Emergency Record

Network

View Live and Playback images across IP network
Copy images across the network

Playback

Search & Playback by Date/Time, Event, Camera
Outstanding picture quality by JPEG 2000 compression algorithm (No mosaic effect)
Suitable for recording not only images but also text

Various steps in Forward Playback Speed (X1/16, X1/8, X1/4, X1/2, X2, X4, X16, X32, X64)
Various steps in Backward Playback Speed (X1/16, X1/8, X1/4, X1/2, X2, X4, X16, X32, X64)
Easy and convenient search by Jog Shuttle & Remote Controller

Data Back-Up

Simple Back-Up using built-in CD Writer (Back-up CD Player included in the package)
Network Back-Up using Remote Viewer program (Remote Viewer included in the package)
Supports larger capacity of HDD (400GB or bigger)

Others

Multi-Language (English, Spanish, Portuguese, German, French, Italy, Japan, Chinese)
VGA support both TFT LCD monitor and CRT monitor (option)
Lock the system by Password
JOG / SHUTTLE
PAL/NTSC Auto detection
Control the unit by using Remote Controller

1-2. Package Contents



1. DVR Main Unit



2. Remote Controller



3. Power Cable



4. Power Adapter

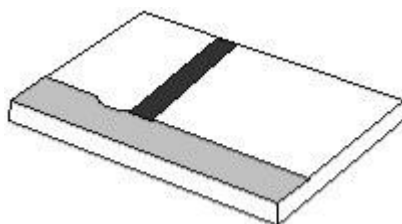

5. User's Manual

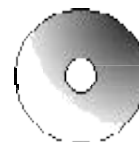

6. Software CD



7. Battery for remote



8. Bolts

Package Contents	Description
1. DVR Main Unit	STAND-ALONE DIGITAL VIDEO RECORDER
2. Remote Controller	DVR control
3. Power Cable	AC power supply to adapters for 12 V DC power
4. Power Adapter	12 V DC power supply to DVR main board
5. User's Manual	User's Manual
6. Software CD	Remote Viewer Software & Back up CD player
7. Battery	Battery for remote controller
8. Bolts	For attaching Hard Disk Drive into DVR

2-1 FRONT

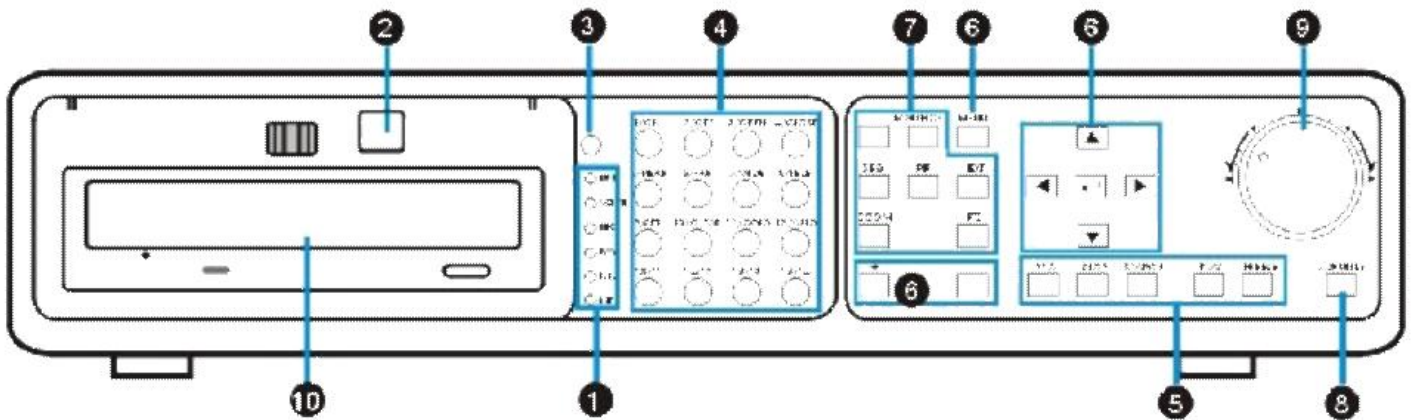

Name	Function	
①LED Lamps	Shows status of operation	
②USB Device	Used to upgrade Firmware only	
③IR	IR receiver	
④Camera selection & PTZ camera control	1. Pressing this button will display a full screen image of that camera	
	2. Control PTZ camera (Each button is assigned for each PTZ command)	
	•ON: LIGHT ON	•SET: SET PRESET
	•OFF : LIGHT OFF	•CLEAR : CLEAR PRESET
	•OPEN : IRIS OPEN	•GOTO : GOTO PRESET
	•CLOSE: IRIS CLOSE	•AUTO : AUTO SCAN
	•NEAR : FOCUS NEAR	•F1 : USER 1
	•FAR : FOCUS FAR	•F2 : USER 2
	•WIDE : ZOOM IN	•F3 : USER 3
•TELE : ZOOM OUT	•F4 : USER 4	
⑤Record / Playback	REC	Emergency Record at continuous, 60ips, SUPER FINE size
	STOP	Record Stop, Playback Stop, or Return to Schedule Record from Emergency Record
	PLAY	Playback of recorded data on HDD
	SEARCH	Search recorded data on HDD
⑥SETUP	MENU	Set up for SYSTEM MENU or Use to exit the menu
	ENTER	Selects each menu option
	NEXT	Move to next step
	▲▼◀▶	Navigate in the menu
	+ -	Reduce or increase the option value in the menu

Name	Function	
⑦ LIVE View Control	PTZ	On/Off for PAN/TILT/ZOOM control mode Press this button first to control PTZ camera connected to DVR unit via RS-485
	ZOOM	Zooming an image
	FRZ	Freezing an Image
	MODE	Switch to split display
	PIP	Display in PIP (Picture in Picture) mode
	SEQ	Auto camera image sequencing in full screen mode
	K.LOCK	Lock the key function
⑧ Jog Shuttle Control	J.SHUTTLE	Pressing Jog Shuttle button (Ready for use Jog/Shuttle): In playback mode, pressing J. SHUTTLE button make images frozen.
		RUN LED on: While you operate Jog or Shuttle
		ACTIVE LED on: When J. SHUTTLE button is pressed
⑨ Jog Shuttle	Very easy and convenient search : Press J. Shuttle button, and images in playback pause, and Jog and Shuttle makes it very easy and convenient to search, forward or backward, fast and slow, as user want.	
⑩ CD-RW	Data Back-up using built-in CD writer	

2-2 REAR

4 Channel

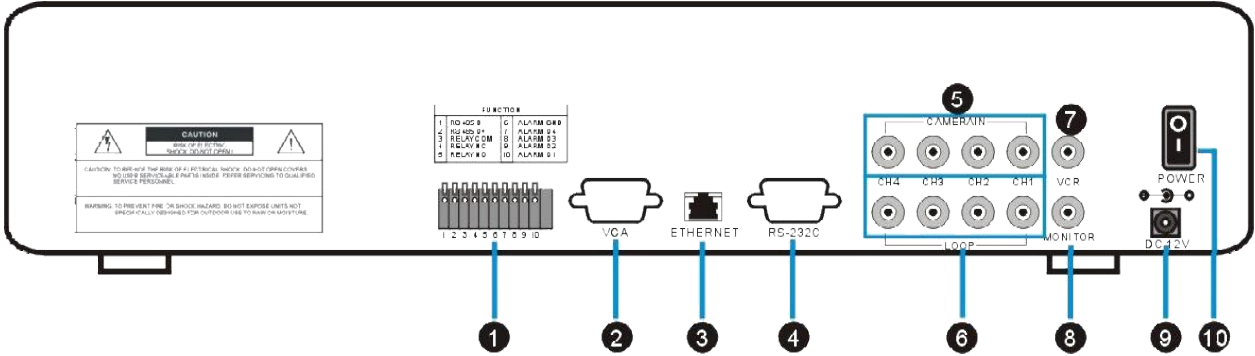

8 Channel

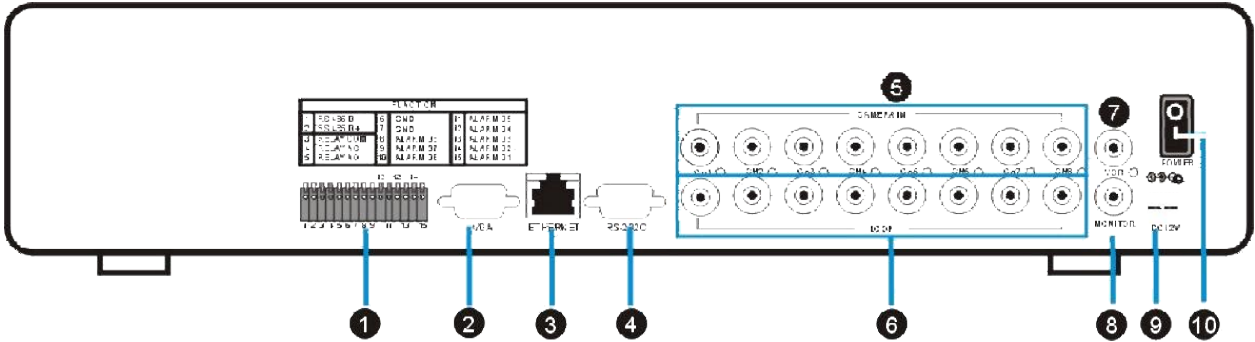

16 Channel

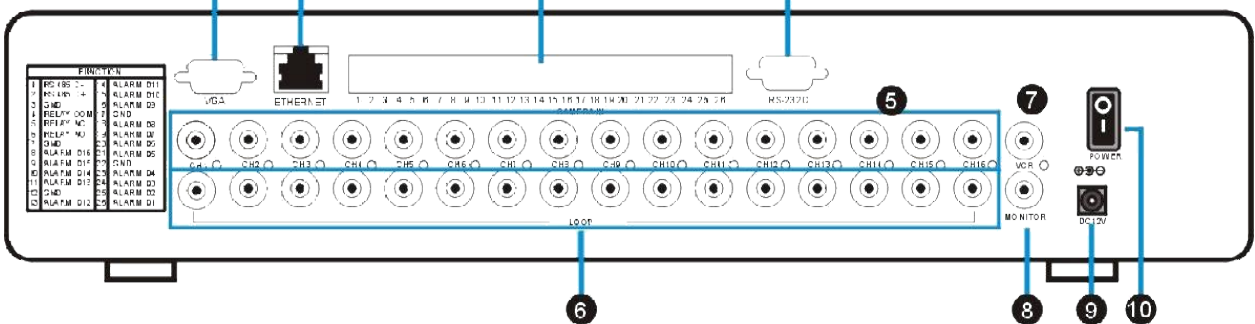

	Name	Functions
1	Rs485	Connection with PTZ Camera or other external device using RS 485 interface (Pin 1: D- / Pin 2: D+)
	RELAY Output	Relay out terminal (Pin 3: Relay COM / Pin 4: NC / Pin 5 : NO)
	SENSOR Input	Sensor input terminal(Pin 6,7 : Ground, Pin 8 ~15 : Sensor input)
2	VGA	Connection to VGA Monitor (CRT type or TFT LCD monitor) Optional. (VGA CONNECTIVITY IS NOT STANDARD)
3	ETHERNET	Connection to ETHERNET device
4	RS-232C	Connection to external device as PC using RS-232C to control the DVR
5	CAMERA Input	Connection with camera
6	LOOP Output	Camera loop out
7	MONITOR Output	Connection with Composite Monitor
8	VCR Output	Connection with VCR for analog backup
9	DC Power	DC power input (DC12V, 10A)
10	POWER SWITCH	Power ON/OFF

CHAP.3 Installation

3-1. Installation Configuration

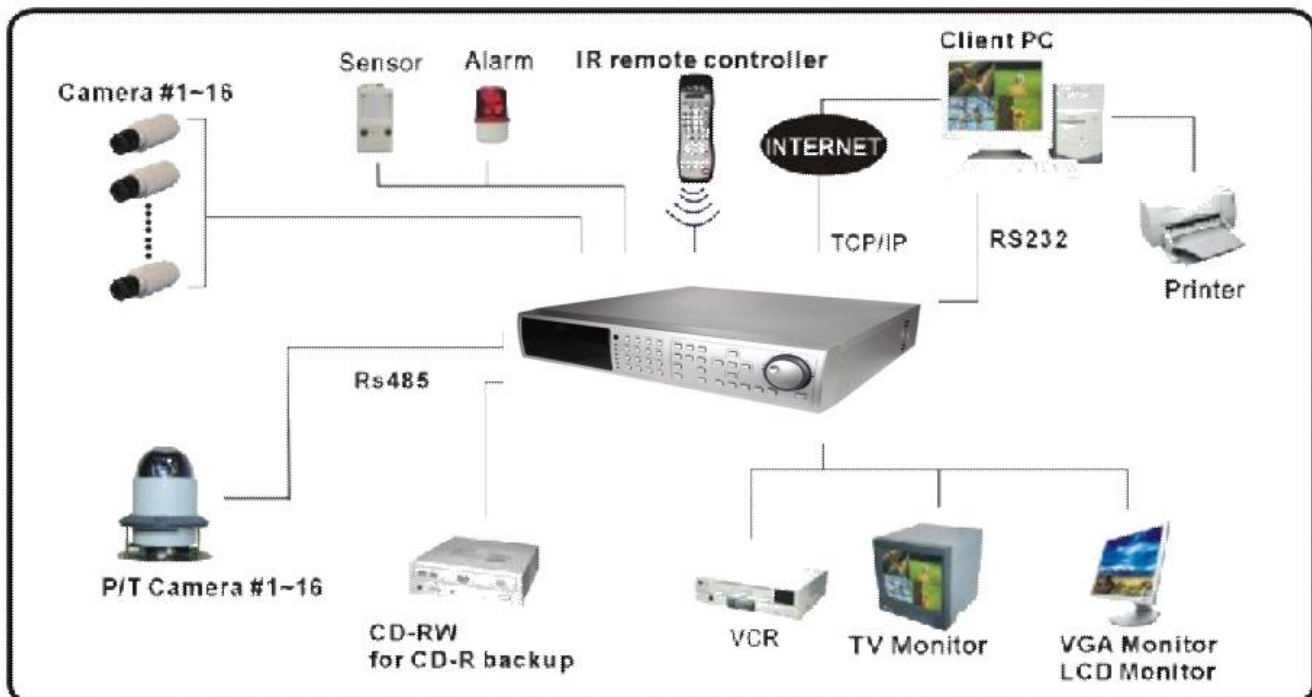

3-2. Detailed Installation

1) HDD

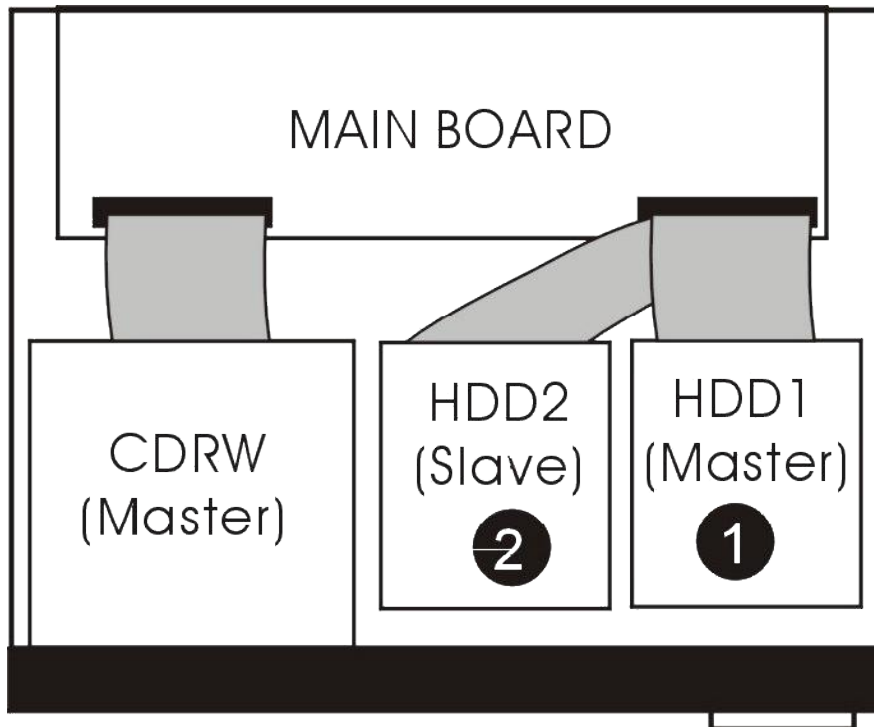

1. Connect Main Board and HDD using IDE cable and HDD power cable.
2. The jumper setting of HDD should be on Master if you install only one HDD.
3. The jumper setting of HDD1 should be on Master and HDD2 should be on Slave if you install two HDDs.(Refer to the above figure)
4. Stick the HDD absorber (included in package) on the bottom of case and then install the HDD on top of them by using the bolts (included in package).
5. Screws must be inserted from outside of the case bottom.

2) Camera

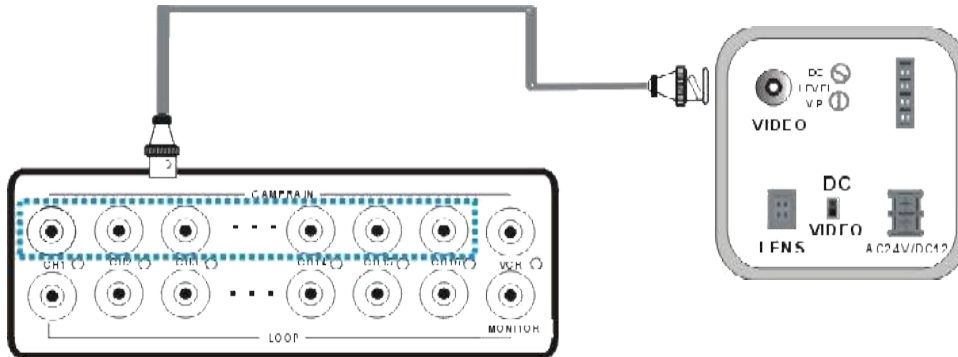

Connect cameras to the camera input on rear panel of DVR marked CAMERA IN.

3) Monitor

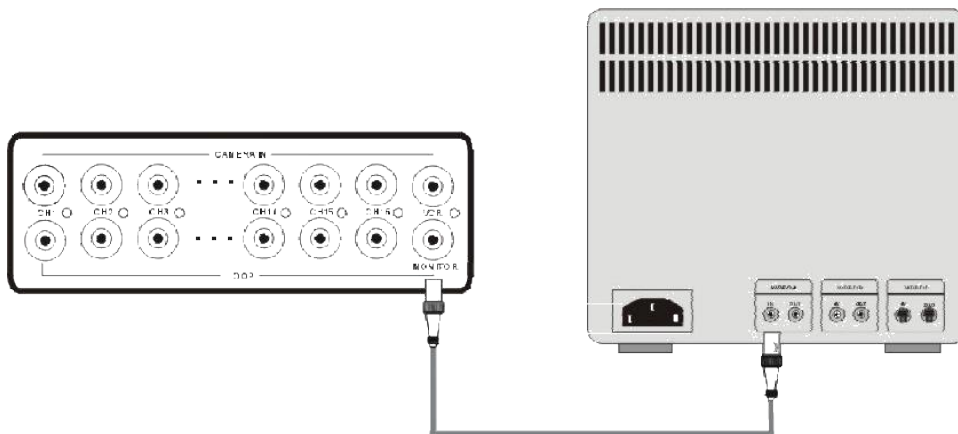

Connect the video output marked MONITOR to Video In of Main monitor.

4) Power

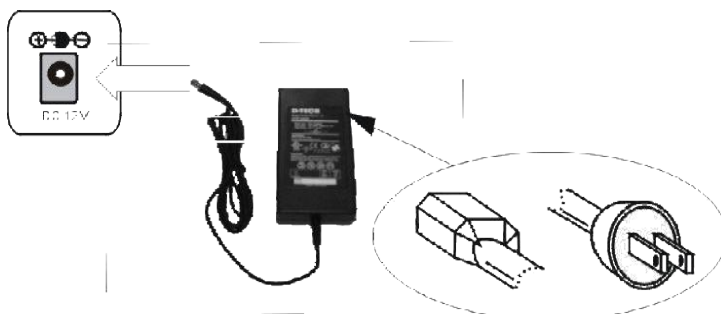

ADAPTER specification: Input AC 110~240V / Output DC12V 10A
Insert the ADAPTER to the rear power socket of DVR.

5) VCR

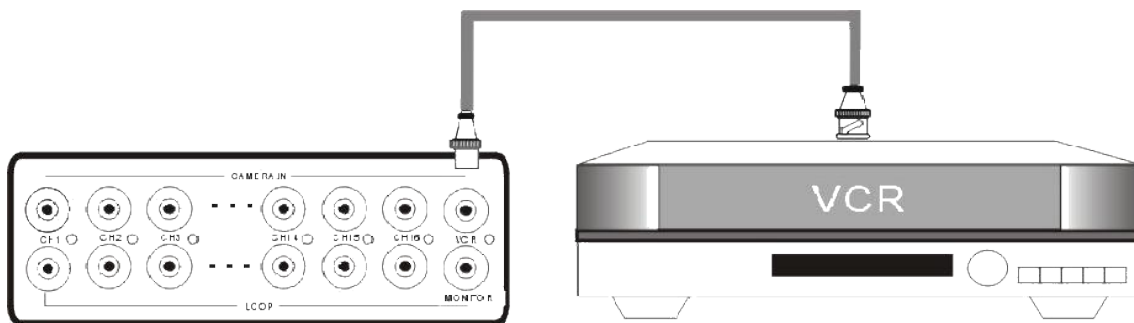

Connect VCR or VIDEO Printer to VCR out on the rear panel of DVR.

6) Other External Device

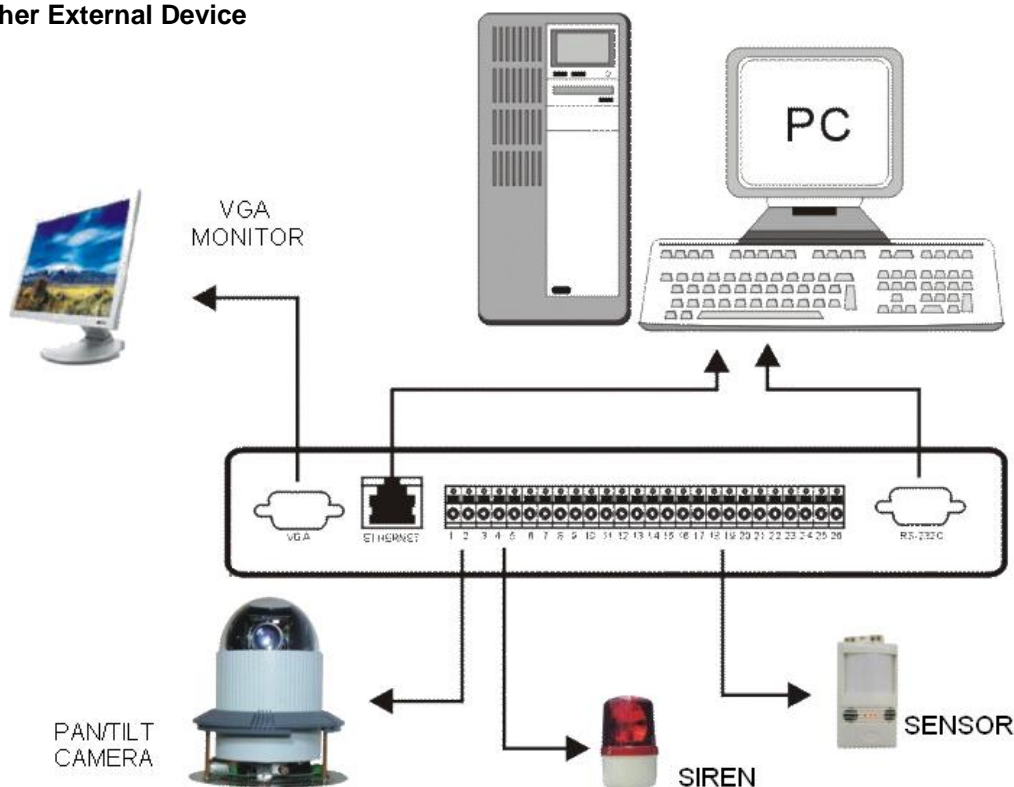

RS-232C : Control DVR through RS-232C port by using PC

RS-485 : Control external device like PTZ Camera (Pin 1, 2 at Terminal Block).

RELAY Output : Relay Output (Pin 3 ~5 at Terminal Block).

SENSOR Input : SENSOR Input (Alarm connection)

ETHERNET: Connection to LAN, WAN, Internet.

VGA: Connection with VGA monitor(CRT,TFT LCD).

Select VGA in DISPLAY SETUP menu before connection to VGA monitor

Setting VGA option board (For both CRT type PC monitor or TFT LCD monitor)

(VGA CONNECTIVITY IS NOT STANDARD)

7) Connector Pin Assignment

No		Description	No		Description
1	DCD	Data Carrier Detect	6	DSR	Data Set Ready
2	RxD	Receive data	7	RTS	RS232C: RX/TX data
3	TxD	Transmit data	8	CTS	RS232C: RX/TX data
4	DTR	Data Terminal data	9		
5	GND	Signal Ground			

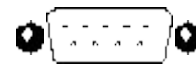

RS-232C

8) RS-232C ASCII-code

Following ASCII-Codes (Hexa-Code) are for programmers who want to control DVR unit via the RS232C Port using keyboard of PC.

All ASCII-Code is 1 Byte.

REC	'R'	LEFT	'H'	ZOOM	'Z'	QPLAY	'Y'	CH7	'7'	CH14	'\$'
STOP	'S'	RIGHT	'K'	FRZ	'F'	CH1	'1'	CH8	'8'	CH15	'%'
PLAY	'P'	NEXT	'N'	MODE	'D'	CH2	'2'	CH9	'9'	CH16	'^'
SERACH	'E'	ENTER	0x0d	PIP	'I'	CH3	'3'	CH10	'0'		
MENU	'M'	-	'<'	SEQ	'Q'	CH4	'4'	CH11	'!'		
UP	'U'	+	'>'	J.SHU	'L'	CH5	'5'	CH12	'@'		
DOWN	'J'	PTZ	'T'	KLOCK	'C'	CH6	'6'	CH13	'#'		

CHAP.4 Operation

4-1. Start-up DVR



Before turning on the DVR be sure that everything is firmly connected. Turn on the DVR and go to the Menu using the relevant Login Password and you will then see the System Setup Screen. You may proceed by referring to the related chapters describing the various functions.

4-2. System Log-In

- 1) To enter into the setup menu, press the [MENU] button.
- 2) Enter password with channel number button from No.1 to No.10 on the front of the DVR unit. (Maximum of 8 digits are available)
- 3) After inputting the password, press the [ENTER] button.

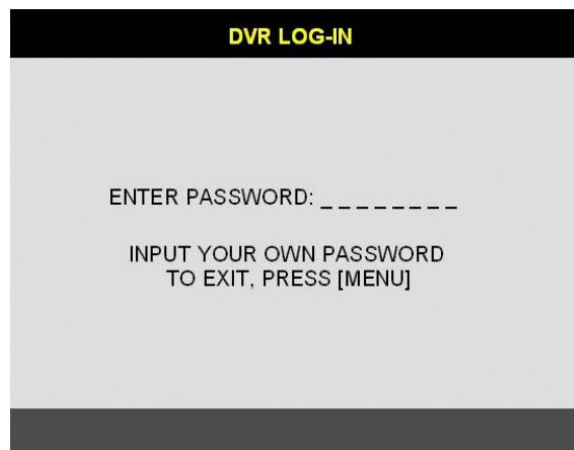

Administrator:

If the password entered matches previously set password, "LOGIN ADMIN" message appears and you can enter into SYSTEM SETUP.

If the password entered does not match previously set password, the DVR unit goes back to live display mode.

Factory default password is blank. For log-in, just press [MENU] button, followed by the [ENTER] button.

-Factory default password

ADMIN: (NULL)

MANAGER: ' 1 '

USER 1~USER 8: ' 2 ' ~ ' 9 '

※We recommend configuring a unique password as per the procedure in SYSTEM MENU - CONFIGURATION - PASSWORD SETUP.

※For security reasons, be sure to make note of your own password.

4-3. Factory Default

Before initial configuring or operation you must first set the Time/Date, followed by setting the unit to the FACTORY DEFAULT settings, lastly clearing the HDD. Please follow these steps in order. Improper operation may result if this action is not taken.

1. FACTORY DEFAULT

DISPLAY SETUP
 CONFIGURATION
 RECORD SETUP
 BACK-UP
 EXTERNAL DEVICE
FACTORY DEFAULT
 LANGUAGE

Refer to page 30.

2 HDD CLEAR.

DISPLAY SETUP
CONFIGURATION
 RECORD SETUP
 BACK-UP
 EXTERNAL DEVICE
 FACTORY DEFAULT
 LANGUAGE

HDD MANAGEMENT
 TIME/DATE SETUP
 CAMERA SETUP
 INTERVAL SETUP
 ALARM SETUP
 BUZZER SETUP
 PASSWORD SETUP
 SYSTEM INFORMATION

Refer to page 21.

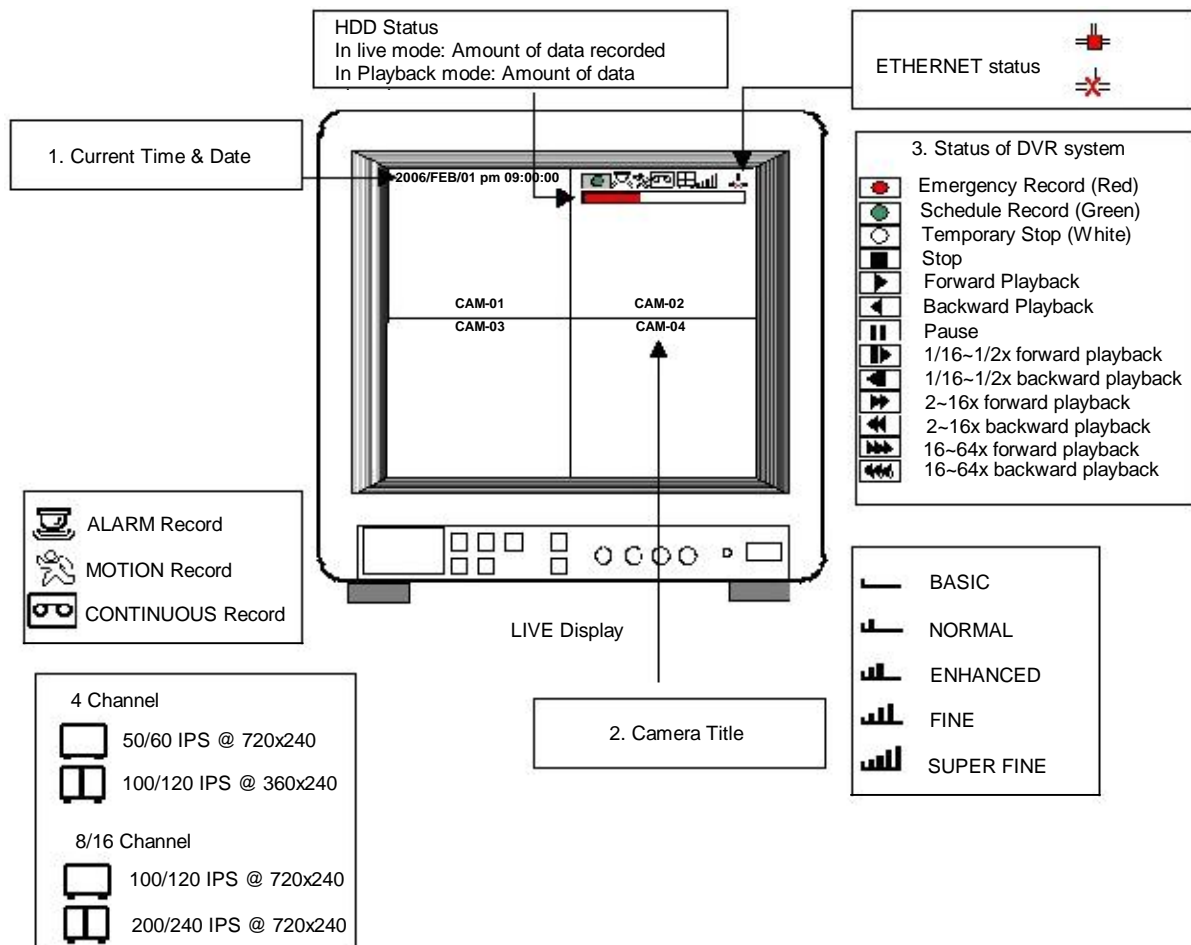

4-5. Live View Setup

1) Full / Multiple View

Switch to multi-screen display by pressing [MODE]. For full image display, just press the channel button which you want or [MODE] button again.

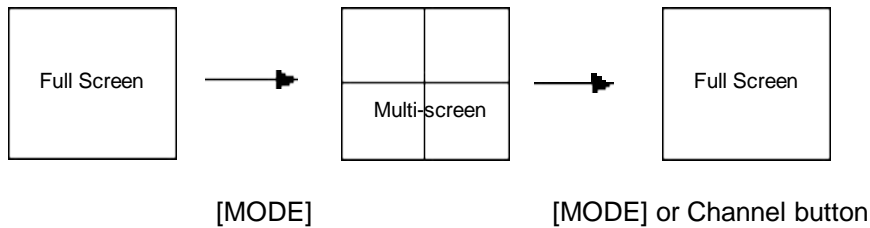

2) View In Sequence

Press [SEQ] button. It automatically displays full screen images in sequence. To stop the sequence press the [SEQ] button.

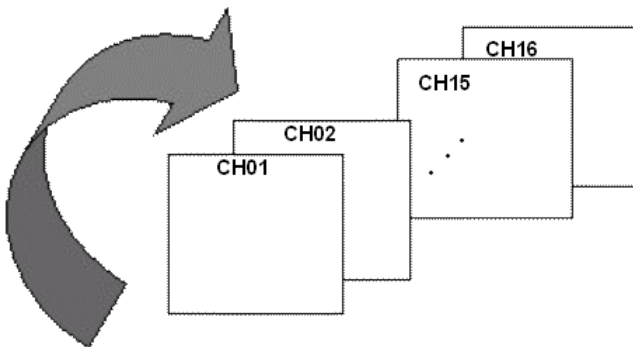

3) Picture in Picture (PIP View)

When it is in full screen display mode, you can see other camera in a small window by pressing [PIP]. The other camera in small window is rotating in sequence to next number of camera and you can set the rotating time interval as per the procedure in *SYSTEM MENU-CONFIGURATION-INTERVAL SETUP*. **Page 24**

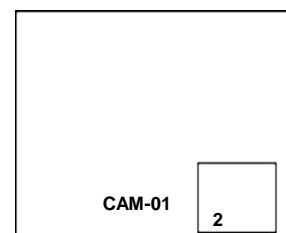

4) Freeze View

Full display mode: If you press the [FREEZE] button, the "F" character will be shown beside camera title, and live image will be frozen.

Split display mode: If you press the [FREEZE] button, press the channel button that you want to freeze (numerous channels can be frozen at any one time). To release frozen image, press channel number of frozen image again and press [FREEZE] button to exit FRZ mode.



5) Zoom View

In full screen, press the [ZOOM] button and move the Selection Frame using direction keys to the area which you want to enlarge. And then press the [ENTER] button for 2-times enlarged picture. To exit Zoom mode, just press [ZOOM] button again.



4-6. Record

Once you press the [REC] button while you see live view, the record type is changed to Emergency Record mode. Recording mode set before delivery by manufacturer (Default recording mode) is Schedule Recording. In this default recording mode, it records 24 hours/day continuously in weekday and on the weekend.

- Emergency Record
Record type : CONTINUOUS, SUPER FINE quality,
4CH: 60 (50) ips at 720X240 (720x288)
8/16CH: 120(100) ips at 720X240 (720x288)
- Schedule Record
Record and stop as set (time interval and record type) in RECORD-SCHEDULE SETUP menu.
- Temporary Stop
Temporary Record stop as set in RECORD-SCHEDULE SETUP menu.

-  Emergency Record [RED]
-  Schedule Record [GREEN]
-  Temporary Stop [WHITE]

On the screen

- **Emergency Record**
: Red Record Icon () and Record LED is lit
- **Schedule Record**
: Green Record Icon () and Record LED is lit
- **Temporary Stop**
: White Icon () and Record LED is off
- **Motion Record**
: Record standby LED blinks
: Record LED is lit

※While in Emergency Record mode, press [STOP], [PLAY], [MENU], or [SEARCH] button to exit from Emergency Recording mode and return to Schedule Record mode.

※For details, refer to the SYSTEM MENU – RECORD page 26

- This DVR unit does not record in following conditions;

- ※In Simplex mode, this unit does not record while entered in the menu or while it is in Playback mode.
- ※No camera is connected
- ※HDD is full and Overwriting is off in the Record Setup menu.

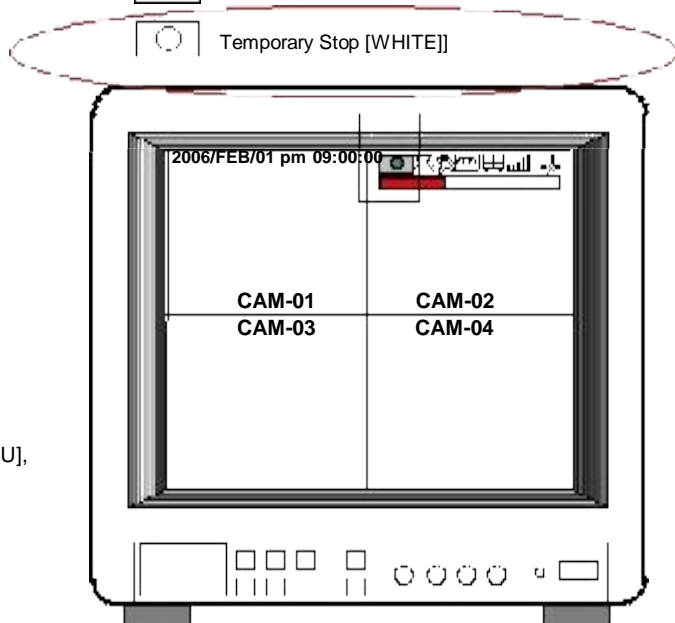

4-7. Playback

On record mode or stop mode, press [PLAY] button to play the recorded data in 1x speed. For backward playback, press [PLAY] button again. Use Jog/Shuttle to pause and control playback speed. To stop playback, press the [STOP] button.

Using Jog/Shuttle

press the [J.SHUTTLE] button in playback mode. The [ACTIVE] LED will be lit, and Jog/Shuttle is ready for use. The [RUN] LED will blink whenever you operate the Jog/Shuttle. For forward playback, turn the Shuttle right and turn Shuttle left for backward playback. Turn the inner Jog using your index figure to see picture by picture in forward or backward direction. Operation of Shuttle is as follows.

If you want to keep the playback speed you selected using Shuttle, just hold the shuttle at that location for a few seconds, and playback in speed you selected continues until you rotate Shuttle again.

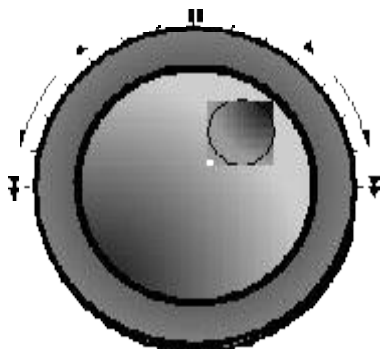

- 1/4 x : 4 times slower than normal playback speed
- 1/2 x : 2 times slower than normal playback speed
- 1 x : Normal playback speed
- 2 x : 2 times faster than normal playback speed
- 4 x : 4 times faster than normal playback speed
- 16 x : 16 times faster than normal playback speed
- 64 x : 64 times faster than normal playback speed

4-8. Search

Press [SEARCH] button, and 3 different methods for searching recorded data are available as shown in following SEARCH window. For selecting searching method, use direction key or Jog/Shuttle. After selecting each search method, press [ENTER] button for playback.

1) SEARCH BAR

Search by percentage of total recorded data, using the arrow keys or the jog shuttle. It starts from image corresponding to set % of data on the search bar.

2) TIME/DATE

Search by time & date. Playback starts from the time & date selected.

3) EVENT LIST

Search by event list (Motion, Alarm, Video Loss).

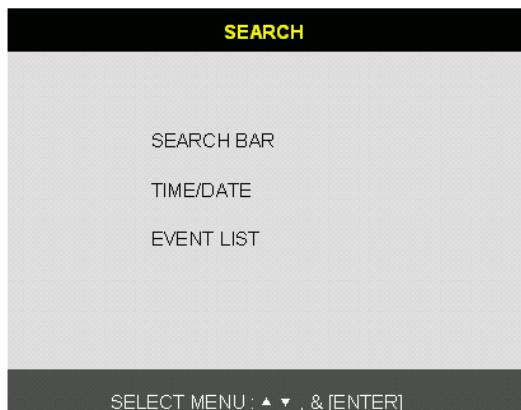

SEARCH page



SEARCH BAR page

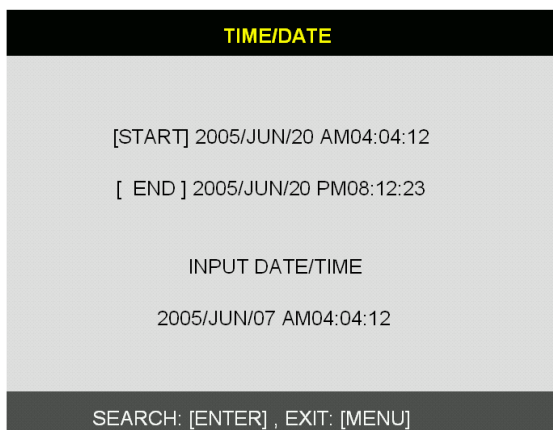

TIME/DATE page

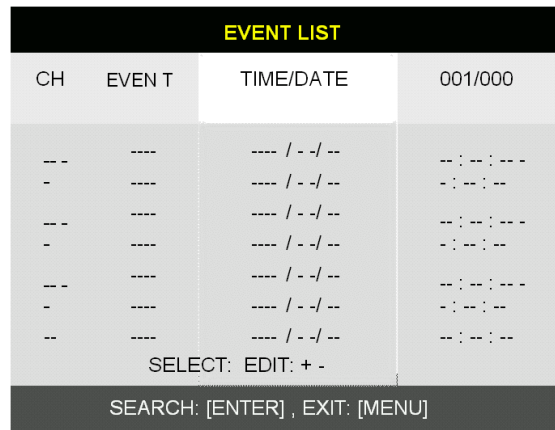

EVENT LIST page

4-9. PAN/TILT/ZOOM Camera Operation

Press [PTZ] button first for PTZ control mode. Numeric buttons from 1 to 16 and direction buttons are assigned for each PTZ command, and user can control PTZ camera connected to DVR unit by pressing any one of those 20 buttons, one after the other, as needed, and it is just like control by separate PTZ controller.

Button	PTZ command	Button	PTZ command
1 /ON	LIGHT ON	10/CLEAR	PRESET CLEAR
2/OFF	LIGHT OFF	11/GOTO	PREST GOTO
3/OPEN	IRIS OPEN	12/AUTO	PRESET AUTO
4/CLOSE	IRIS CLOSE	13/F1 ~16/F4	FUNCTION
5/NEAR	FOCUS NEAR	UP BUTTON	TILT UP
6/WIDE	FOCUS FAR	DOWN BUTTON	TILT DOWN
7/WIDE	ZOOM IN	LEFT BUTTON	PAN LEFT
8/TELE	ZOOM OUT	RIGHT BUTTON	PAN RIGHT
9/SET	PRESET SET		

4-10. Data Back-Up

Enter into SYSTEM MENU-BACKUP-CDR SETUP.

- 1) Insert empty CD-R media into CD writer and select the start time & date from which you want to back up. ※The START & END time / date in HDD sub-menu only shows start and end of recording. This is not selectable and editable.
 ※700MB on CD-R sub-menu represent size of CD-R media inserted.
- 2) To set start time of back-up and back-up data size, press the [ENTER] button first on [START] or [SIZE] sub-menu and adjust using [+] or [-] button and move using [LEFT] and [RIGHT] button for next change. After setting the time & date and back-up data size, press the [ENTER] button again to exit.
 ※End of back-up time will be calculated automatically as per start time & date and the back-up data size you set.
 ※User can select the back-up data size (size of back-up data from start of back-up) on [SIZE] item but END of back-up time is automatically determined by DVR system.
- 3) Press [ENTER] button on BURN sub-menu. DVR system starts burning CD.
- 4) When burning is completed, CD-R media will come out automatically. In the next CD back-up, start time of CD-R shall be the end time of previous CD-back-up, and you can back-up from that for continuous data back-up. If you need another backup, repeat the above procedure. To stop backup, press the [MENU] button.
 ※During burning CD, it's impossible to cancel burning process.
- 5) User can verify the back-up CD on PC with BACK-UP CD PLAYER (Included in Package).

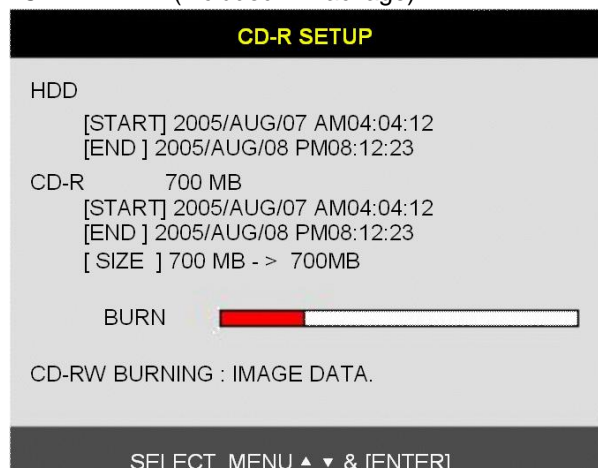

CHAP. 5 Set Up

5-1. Entering into the Menu

Enter into SYSTEM MENU by pressing [MENU] button.

BUTTON	FUNCTION
MENU	Enter into SYSTEM MENU, Move to previous menu, ESC
ENTER	Selection key, Move to sub-menu, change status (ON or OFF)
NEXT	Move to next page
UP	Move to upper side
DOWN	Move down side
LEFT	Move to the left
RIGHT	Move to the right
MINUS [-]	Reduce the option value
PLUS [+]	Increase the option value
Jog Shuttle	Jog left turning: Move backward to next image / Decrease value Jog Right turning: Move forward to next image / Increase value
	Shuttle left turning: Reduce playback speed / Decrease value Shuttle right turning: Increase playback speed / Increase value

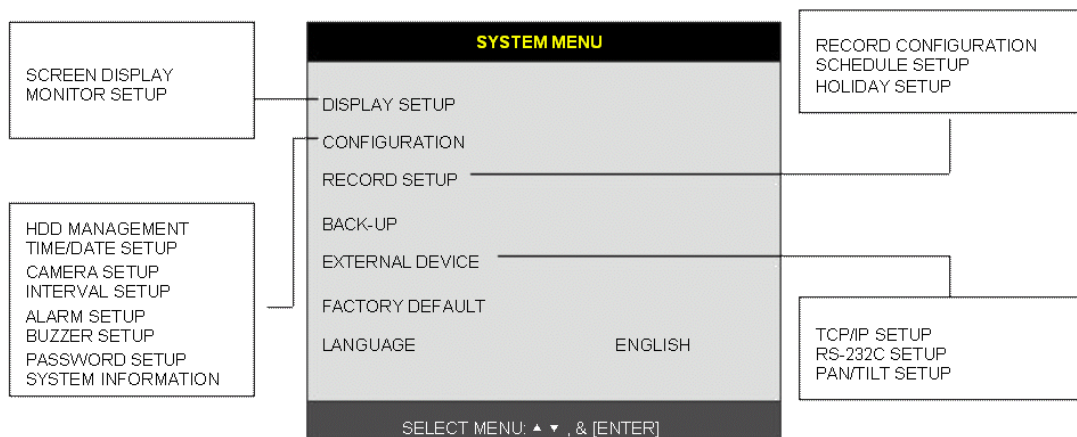

SYSTEM MENU

5-2. DISPLAY SETUP

Setting up parameters for monitor and display on screen.
Enter into SYSTEM MENU-DIPLAY SETUP.

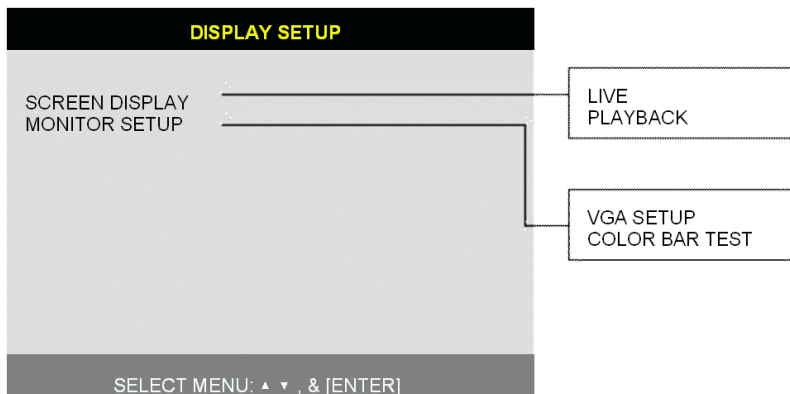

1) SCREEN DISPLAY

Setting up the screen display in LIVE mode and PLAYBACK mode.

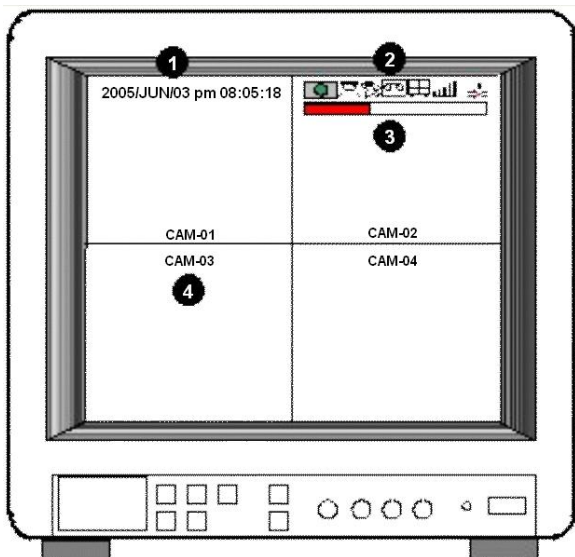

Select the sub-menu, that you would like to set using direction buttons and then change ON/OFF with [ENTER] button.

- 1. TIME/DATE: Display time & date
- 2. DVR STATUS: Display system setting status
- 3. REC/PLAY BAR: Display record / playback status
- 4. CAMERA TITLE: Display camera title

2) MONITOR SETUP

VGA SETUP: User have to select one the below option to optimize with the monitor using [+] [-] button. After setting the below option, press [ENTER] button then the DVR unit will be rebooted automatically. **[VGA board is an option and will not be installed]**

- 800-600 / 60Hz : set when the VGA monitor(800x600 / 60Hz) is connected to DVR unit
- 640-480 / 60Hz : set when the VGA monitor(640x480 / 60Hz) is connected to DVR unit
- 800-600 / 75Hz : set when the VGA monitor(800x600 / 75Hz) is connected to DVR unit
- 640-480 / 75Hz : set when the VGA monitor(640x480 / 75Hz) is connected to DVR unit

COLORBAR TEST: Necessary to adjust color tone of monitor.

※NOTICE: In the very first operation of this DVR unit which has VGA card in it, when the user turns on the DVR, it takes a few seconds to boot up for initialization of VGA.

(VGA CONNECTIVITY IS NOT STANDARD)

5-3. CONFIGURATION

Various parameters for system can be set in CONFIGURATION menu.
Enter into SYSTEM MENU-CONFIGURATION and press the [ENTER] button.

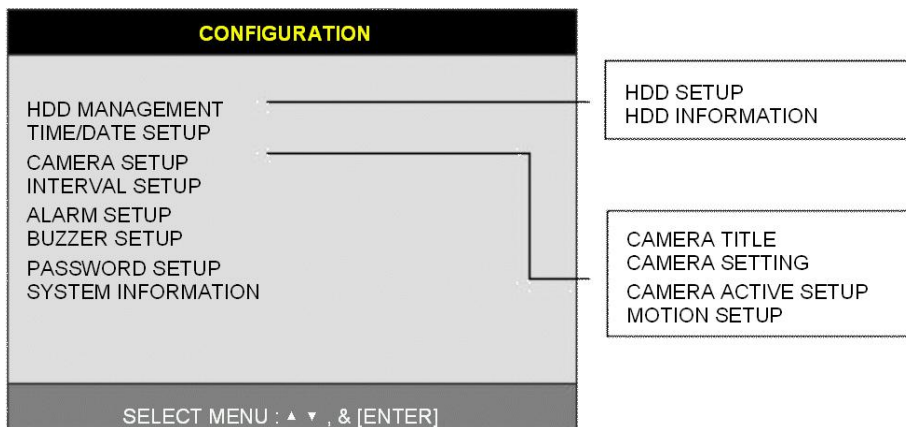

1) HDD MANAGEMENT

Enter into SYSTEM MENU-CONFIGURATION-HDD MANAGEMENT and press the [ENTER] button.

(1) HDD SETUP

This page includes information about start and end of recording, location of recorded data, or location of last playback on HDD. In addition, users can delete all the data on HDD.

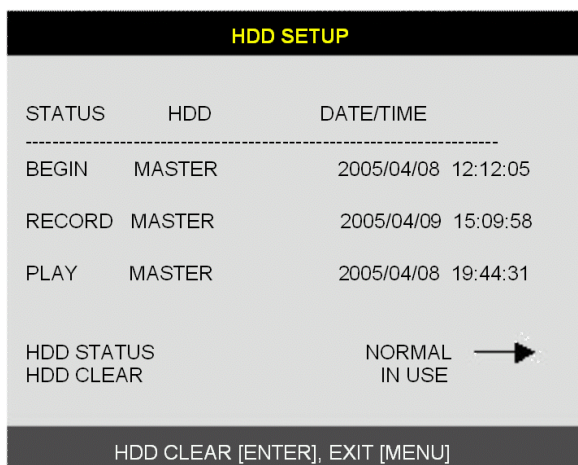

On the [HDD CLEAR] sub-menu, press the [ENTER] button to delete all image data on HDD.

The system will ask password for verification. After you clear all data on HDD, status of HDD CLEAR changes from IN USE to EMPTY.

※When you clear HDD, event list is deleted, too.

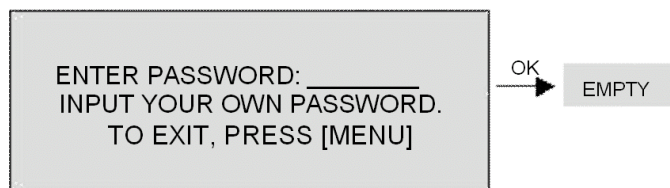

(2) HDD INFORMATION

This menu will show the physical information of HDD in DVR.

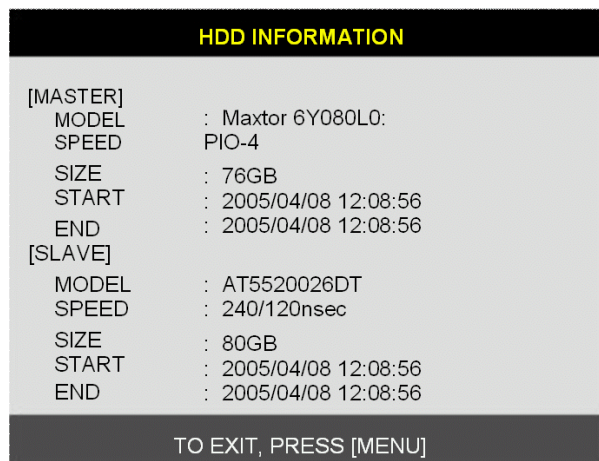

2) TIME/DATE SETUP

Set time and date of DVR system, It is very important for search with time and date of the event. Time and date set by manufacturer is different from local time of user, and user must set time and date exactly in first operation. Set time & date using direction buttons and [-][+] button or Jog shuttle.

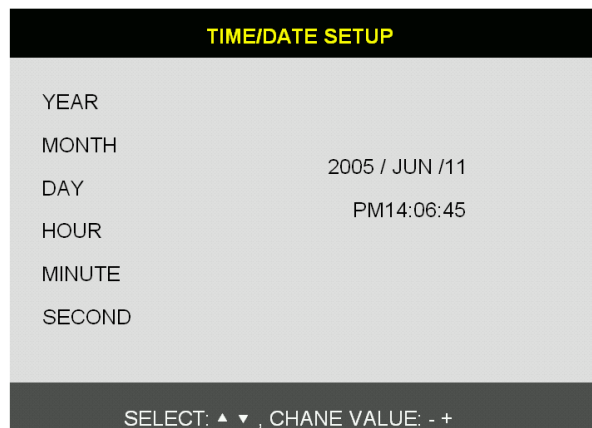

3) CAMERA SETUP

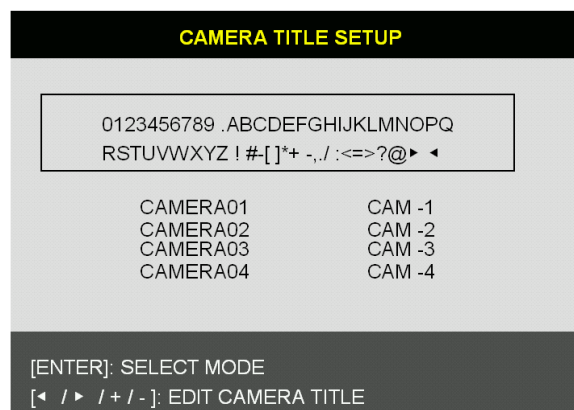
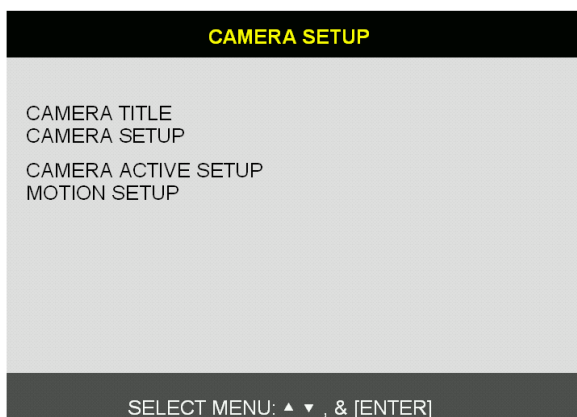

(1) TITLE: Input Title of each camera. Move to channel you want to change using [LEFT] or [RIGHT] direction button and then change the title-using [-] [+] button. When modification is finished, press the [ENTER] button. To exit to previous menu, press the [MENU] button.

(2) COLOR: Adjust image color
 Move to each element using [UP][DOWN] button and adjust using [-] [+] button or Jog shuttle.
 Using enter to confirm the settings.

CHANNEL: Select camera to modify
 BRIGHTNESS: Adjust image brightness (-32~ 31)
 CONTRAST: Adjust color contrast (-32 ~ 31)
 SATURATION: Adjust color saturation (-32 ~ 31)
 HUE: Adjust color hue (-32 ~ 31)

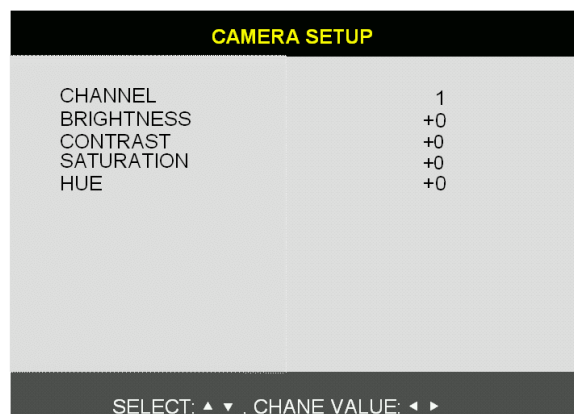

CAMERA ACTIVE SETUP			
CH	STATUS	LIVE	REC
01	ACTIVE	ON	ON
02	ACTIVE	ON	ON
03	LOSS	OFF	OFF
04	ACTIVE	ON	OFF

SELECT : ▲▼, CHANGE VALUE : ◀▶

MOTION SETUP	
CHANNEL	01
SENSITIVITY GRADE	01
MOTION DISPLAY TYPE	OFF
RECORD DURATION	05 SEC

SELECT ▲▼, PRESS

- (2) CAMERA ACTIVE SETUP: With direction button, move to option to be changed, and press [ENTER] button to select [ON/OFF]. If it is set at LIVE [OFF] and REC [ON], DVR system records, but does not show live image of set channel.

- STATUS: Shows if image from a specific channel is coming for live display and recording. In normal camera condition, it is ACTIVE, but LOSS is displayed when the cable is disconnected or camera is not working.
- LIVE: Decides whether to show LIVE screen image or not.
- REC: Decides whether to record relevant channel or not.

4) MOTION SETUP: You can set sensitive of motion detection in 4 steps, detection window number, motion detection area and others in relation to motion recording in this menu.

(4)-1. MOTION SETUP

- SENSITIVITY GRADE: Adjusts motion detection sensitivity. 1 (LOW) ~ 4 (VERY HIGH)
- MOTION DISPLAY TYPE: Showing cells with motion detected differently from cells with no motion.
- RECORD DURATION: Whenever motion is detected and it is set at Motion Recording mode, DVR system records for RECORD DURATION from time motion is detected. (1sec. ~ 99 sec.) (Default duration: 5 sec.)

4)-2. MOTION MASK SETUP

Set motion detection area. Direction button is for moving and [ENTER]

- CELL: Move to the location that you want to detect and then press the [ENTER] button. Highlighted cell area means motion detection area.
- ALL ON: Set all cells as detection area. Use [ENTER] button to set.
- ALL OFF: Set all cells as no-detection area. Use [ENTER] button to set
- BLOCK ON: Select detection area by block. Use [MODE] button and press [ENTER] button to set ON.
- BLOCK OFF: Select un-detection area by block. Use [MODE] button and press [ENTER] button to set ON.

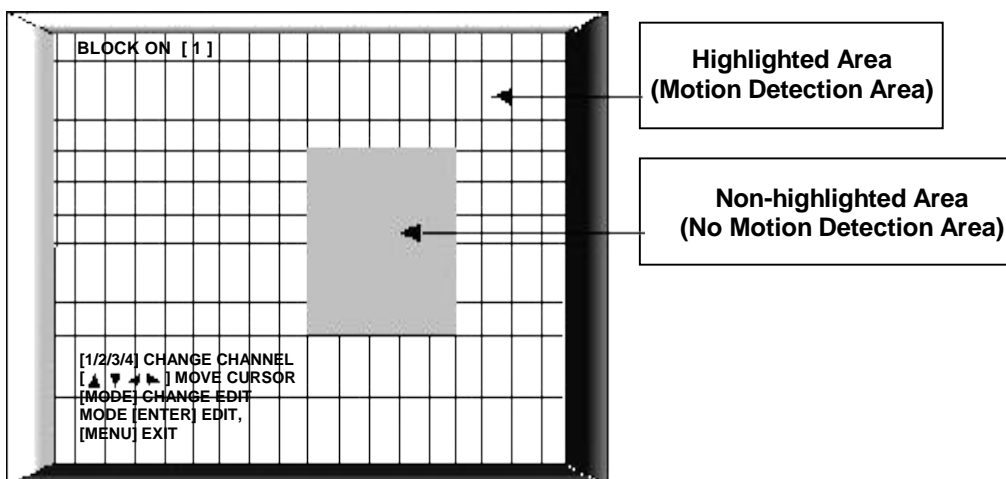

4) INTERVAL SETUP

Set the switching time interval for SEQ or PIP function.(1sec. ~ 99 sec.)

FULL SCREEN: set the sequencing switch time interval in live full screen.

PIP SCREEN: set the sequencing switch time interval of PIP window.

EVENT UPDATE TIME: Set the minimum time interval of event to be listed in EVENT LIST If EVENT UPDATE TIME is set at 20 sec, only following event happened 20 sec or more than 20 sec later previous event shall be listed in EVENT LIST.

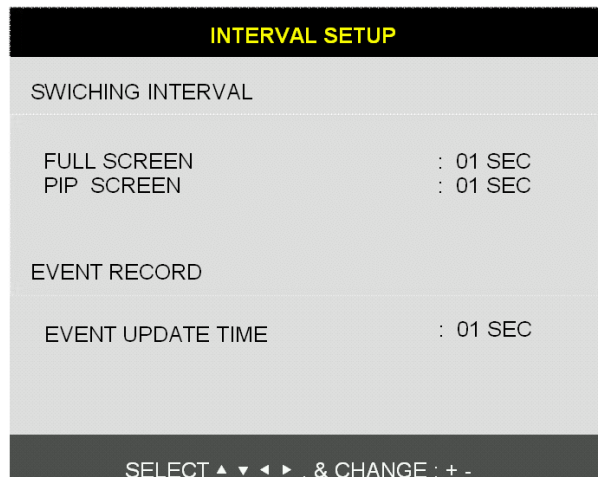

5) ALARM SETUP

Set type of alarm sensors connected to DVR unit. N.O represents Normal Open type and N.C Normal Close type.

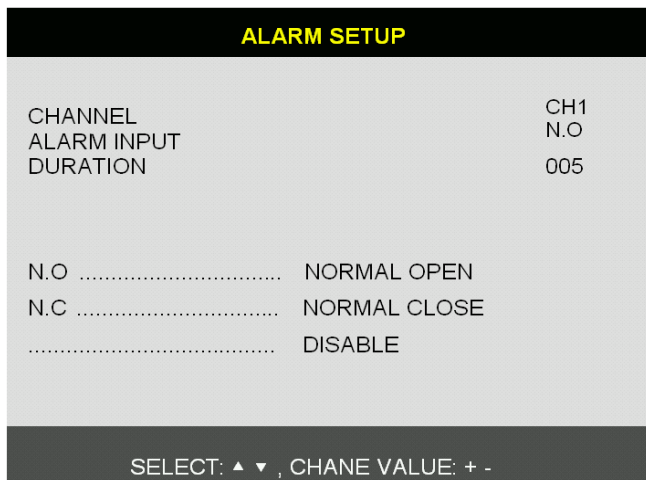

- 1) ALARM INPUT: Select type of alarm sensor connected to DVR unit (N.O or N.C). Use direction button and [-] [+] button to set. DISABLE represent not to use alarm sensor connected to DVR.
- 2) DURATION: Set the duration of alarm when an ALARM is activated. (0 sec. ~ 300 sec.)

6) BUZZER SETUP

Set parameters for buzzer (On or Off).
Use direction button and [ENTER] button.

KEY BEEP: buzz when button is pressed.
VIDEO LOSS: buzz when video signal is lost.
ALARM ACTIVE: buzz when alarm is activated.
MOTION DETECT: buzz when motion is detected.

User can set all buzzers at On/Off at once by set ALL ON.

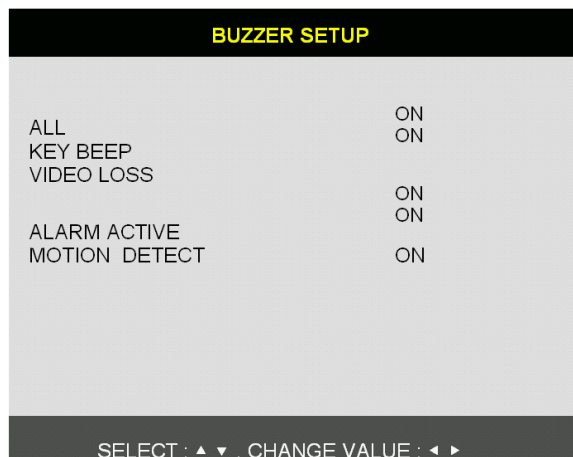

7) PASSWORD SETUP

Set user ID and password.

-Use [UP] and [DOWN] button to move to option and [LEFT] and [RIGHT] button to set user ID.

The password must be consisting of 1 to 8 digit numbers.
Just use numbers button from 1 to 10 on the front panel of DVR unit.

-To change password, user must input current password and then input new password. And input again new password to confirm.

- Default value
ADMIN: "" (NULL)
MANAGER: '1'
USER 1: '2'
:
:
USER 8: '9'

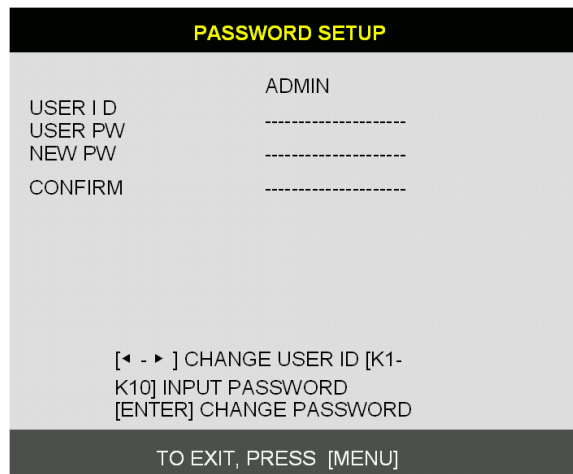

※Change the user PASSWORD in the first operation is recommended.

※In case you forgot PASSWORD, contact dealer of DVR to get instruction to enter into menu to set new PASSWORD.

8) SYSTEM INFORMATION

DVR system information including model number, firmware version, hardware version, etc.

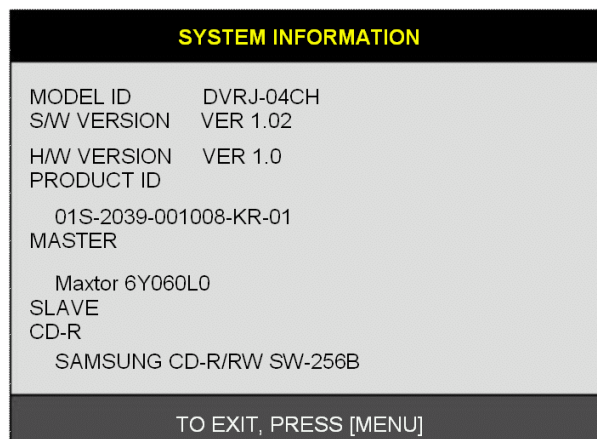

5-4. RECORD SETUP

This is the most important configuration of the DVR. Enter into SYSTEM MENU-RECORD SETUP and press the [ENTER] button.

1) RECORD CONFIGURATION

Use direction button to move and [-] [+] button to set value.

(1) OVERWRITE: Set overwrite or stop recording when the HDD is full.

(2) MULTIPLEX: Set DUPLEX. Or TRIPLEX

- DUPLEX: Playback or Record/Remote live simultaneously.
- TRIPLEX: Record/Playback/Remote live simultaneously. Under triplex mode, the record and playback speed will decrease 50% of frame rate.

3) QUALITY: Set record quality. Actually it is fixing data size of image for each picture quality level; BASIC / NORMAL / ENHANCED / FINE / SUPER FINE

(4) RESOLUTION: Set recording resolution.

- 120 ips at 720x240 (720x288)
- 240 ips at 360x240 (360x288)

※Images recorded in 360x240(360x288) It is not possible to see those images in full screen mode in playback. Recording in half or quad resolution is recommended for higher recoding speed.

(5) RECORD SPEED: Set record speed of alarm/ motion/ continuous mode (or skip rate)

- 1/1x, 1/2x,1/999x record speed

ex: 1/2x) R->S->R->S...

ex: 1/3x) R->S->S->R->S->S->R...

ex: 1/4x) R->S->S->S->R->S->S... (R : RECORD S : SKIP)

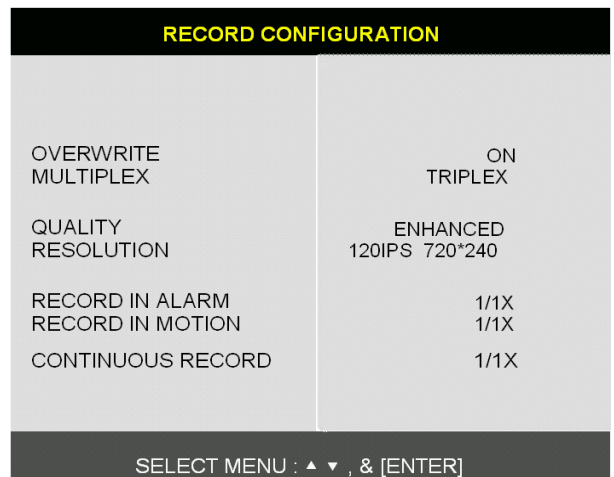
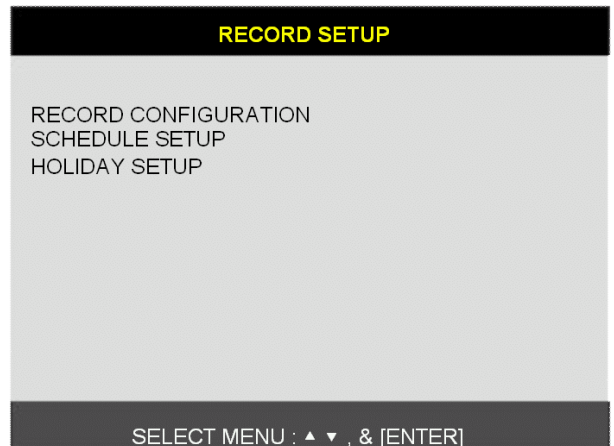

2) SCHEDULE SETUP

Unless you selected other recording mode, DVR system records in Schedule Recording mode. In SCHEDULE REC SETUP, you set type of recording for every time interval of 2 hours in each day of the week. Schedule Recording set by manufacturer is recording continuously at its full recording speed, and it means DVR system record continuously at 120 ips in total at 720x240 resolution. To set Schedule Recording parameters, enter into SYSTEM MENU-RECORD SETUP-SCHEDULE SETUP and Press the [ENTER] button.

(1) SCHEDULE SETUP

Set recording type for each recording time interval for a day of the week (2 hours interval).

SCHEDULE REC SETUP							
00-02	SUN - M-	MON AM -	TUE - -C	WED - -C-	THU - -C-	FRI - -C	SAT - -C
02-04	-M -	AM -	--C	--C	--C	--C	--C
04-06	-M -	AM-	--C	--C	--C	--C	--C
06-08	-M -	AM-	--C	--C	--C	--C	--C
08-10	--	AM-	--C-	--C	--C	--C	--C
10-12	--	AM-	--C	--C	--C	--C	--C
MODE: CELL BY CELL							1 / 2
SELECT: ▲ ▼ ◀ ▶ & [NEXT], EDIT [+ -]&[MODE]							
A: ALARM M: MOTION C: CONTINUOUS							

Use [MODE] button to select edit type and move to the time interval of a day of the week you want to change. Press [ENTER] button to select and use [+] or [-] button, to change the record type. To go next page, use [NEXT] button.

※MODE (Edit type)
TIME CELL: Set each time interval of a day of the week

DAY OF THE WEEK: Set a day of the week at once

TIMEZONE: Set a time slot at once

ALL: Set page by page at once

CLEAR ALL: Clear page by page

※Except when EMERGENCY record is enable, the DVR system records based upon the SCHEDULE Record Setup.

※DEFAULT record mode for each time interval of a day of the week set by manufacturer is CONTINUOUS recording.

※Record type:

After power on → Schedule record

Exit from menu → Schedule record

End of search or playback → Schedule record

After pressing [STOP] button → Schedule record

After pressing [REC] button → Emergency record (

Continuous recording at full recording speed) (120(100) ips at 720x240(720x288))

3) HOLIDAY SETUP

Users can set national holiday or holidays on calendar to record just as setting for Sunday in Schedule recording.

Use [MODE] button to select a month and direction button to move to a day, and press [ENTER] button to set a holiday. Then color of date shall be changed to red, as Sunday.

※The maximum number of holidays that can be set is 100 days.

HOLIDAY SETUP							
< AUG >						000/100	
SUN	MON	TUE	WED	THU	FRI	SAT	
						01	02
03	04	05	06	07	08	09	
10	11	12	13	14	15	16	
17	18	19	20	21	22	23	
24	25	26	27	28	29	30	
MODE : MONTH							

5-5. BACK-UP

User can back up the recorded data to CD using CD writer installed in DVR. Refer to [START] and [END] of data on HDD and set copy from time, [START], and size of data copied, [SIZE], and move to BURN and press [ENTER] button to start copy.

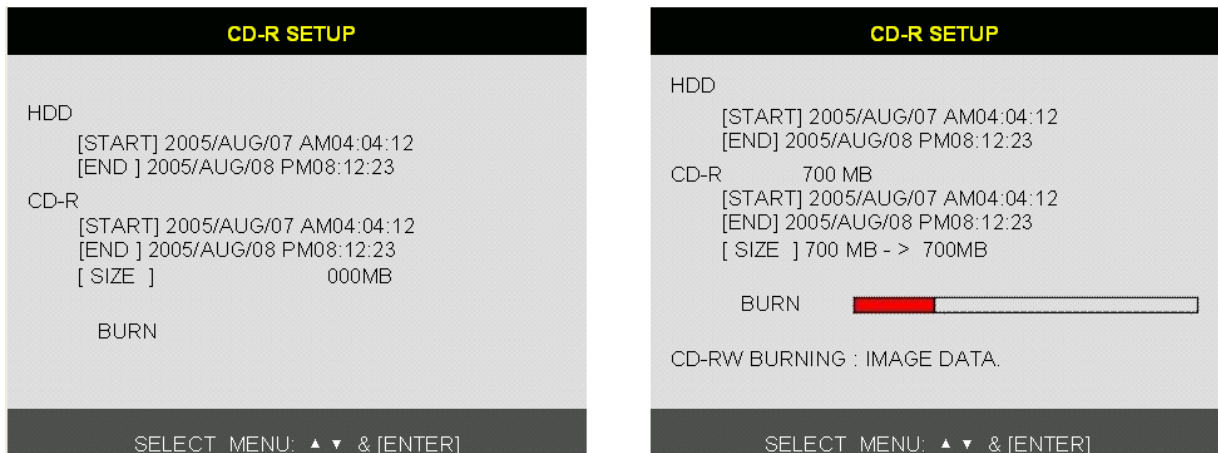

System Status Messages:

- CD-RW DOOR CLOSE. CHECKING CD-R: Blank CD check
- INPUT BLANK CD: CD writer has no blank CD.
- CD-RW DOOR OPEN: Open CD-RW and insert blank CD –R media into CD drive.
- CD-R MEDIA IS DETECTED: Blank CD-R media has been inserted and detected. DVR system will display size of blank CD-R.

After you set [START] time and [SIZE] in CD-R sub-menu and then select BURN, DVR system starts copying images to CD and shows following message.

CD-RW BURINING: START
 CD-RW BURNING: LEAD-IN
 CD-RW BURNING: IMAGE DATA
 CD-RW BURING: CLOSE TRACK
 CD-RW DOOR: OPEN

When burning is completed, CD-R media will eject automatically.

To copy more images, repeat above process. In next process, [START] time in CD-R sub-menu shall be [END] time in previous back-up, and you can copy images in series to many CDs as many as you want.

Note: See also page 18

5-6. EXTERNAL DEVICE

Set parameters of external devices connected to DVR, like Ethernet, PTZ camera, RS-232C, etc. Use direction button to move to sub-menu and Press [ENTER] button to set.

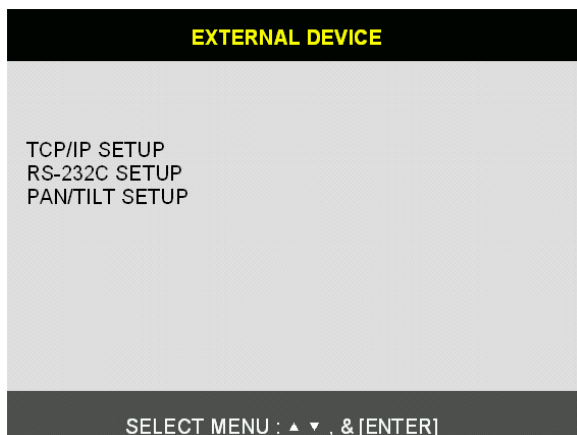

1) TCP/IP SETUP

TCP/IP function enables user to see live pictures and recorded pictures via the Internet. To use the TCP/IP option, user must assign IP ADDRESS & GATEWAY & SUBNETMASK into DVR in TCP/IP SETUP MENU. Also, user must install the Remote viewer program to PC from which user want to access to DVR unit Via IP network. For detail procedure of Remote viewer program installation, refer to CHAP. 6 Software program.(Remote viewer software).

Move to sub-menu you want to change and press [ENTER] button to set value. Press direction button to move and [+] and [-] button to set value.

TCP/IP SETUP	
MAC ADDRESS	00-0A-A2-00-00-00
IP ADDRESS	192.168.001.160
IP PORT	08000
GATEWAY	192.168.001.001
SUBNET MASK	255.255.255.000
DHCP SETUP	MANUAL

SELECT MENU : ▲ ▼ , & [ENTER]

2) RS-232C SETUP

User can control the DVR via RS-232C port. Connect DVR to PC via RS-232C port and user can control DVR using keyboard of PC. This function is mainly for programmer who wants to control DVR as part of many devices connected to PC system, as in SI project.

RS-232C SETUP	
SPEED	576000
LENGTH	8
STOP BIT	1
PARITY	NONE

SELECT : ▲ ▼ , CHANGE VALUE : ◀ ▶

3) PANTILT SETUP

It is to set parameters for PTZ camera connected to DVR unit. DVR unit already includes all protocols of well-known PTZ cameras like PELCO D type PTZ camera, and user just select MODEL and set other parameters to control this PTZ cameras, using operation buttons on the front panel of DVR. If PTZ camera whose protocol is not incorporated into this DVR unit, user must input protocol of this PTZ camera by himself. Using USB device port, user can upgrade protocol for PTZ camera.

PANTILT SETUP	
COMMAND SETTING	PTZ camera set
SPEED SETTING	PTZ speed set

SELECT: ▲ ▼ , CHANGE VALUE: ◀ ▶

COMMAND SETTING	
CHANNEL	01 PELCO-
MODEL	D 000
PTZ ID	
BAUDRATE	2400 BPS
CMD DELAY	1 MSEC
COMMAND LENGTH	PANTILT STOP
CODE	0.7
	FF 00 00 00
	00 00 00 00

SELECT: ▲ ▼ , CHANGE VALUE: ◀ ▶

- 1) CHANNEL: Select channel
- 2) MODEL: Select camera model (protocol type)
- 3) PTZ ID: Select ID
- 4) BAUDRATE: Select data transmission speed
- 5) CMD DELAY: Select command delay time

5-7. FACTORY DEFAULT

Set the all system parameters as manufacturer first set before delivery. It is a kind of system initialization, and manufacturer recommend to do it when you add new HDD or other changes in system to make all system ready for normal operation. Use direction button to move and Press [ENTER] button to change parameters. After move to RUN, Press [ENTER] button for actual Factory Default setting.

5-8. LANGUAGE SETUP

Press [+] / [-] button to select your language.

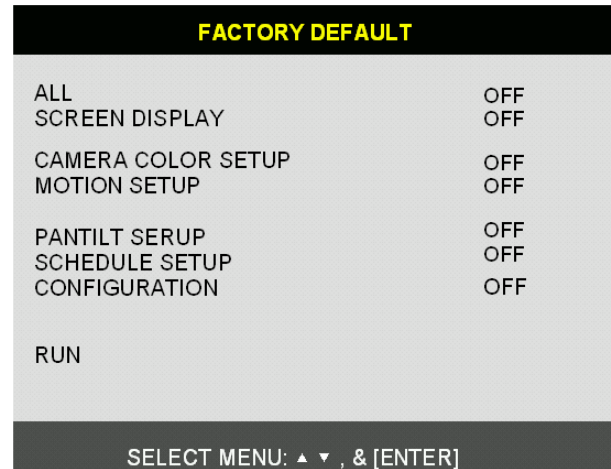
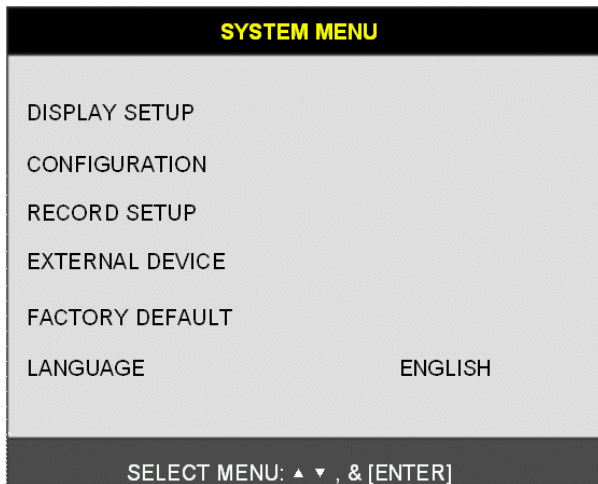

CHAP. 6 Network Setup

6-1. DVR Network Configuration

Now that you are familiar with the equipment and should be able to identify a router from a modem and a Cat5 network cable from a telephone cable, we will proceed to explain network / remote viewing configuration.

Please call your provider to identify what type of service they are providing you. You will need to know following;

Upload speed – For your own knowledge for expected frame rates
Download speed – For your own knowledge for expected frame rates
Addressing – For determining what scenario you should follow
Router On Site – For connecting to the outside world

※ Note: For remote viewing we recommend using a Broadband ADSL connection or faster.

※PLEASE verify Internet access after installing any new equipment (routers, switches, modems, etc.). If possible, use a PC on the network to verify that an Internet connection can be made and that all current configurations on any equipment are up and working properly. Do this before doing ANY configurations with the DVR. We are assuming that your current equipment is configured properly for Internet access.

PC's TCP/IP Setting

Before configuring the DVR, please fill out the information below if applicable;

Choose any PC on your network and determine its TCP/IP settings;

IP Address: _____ (ex.192.168.1.5)

Subnet Mask: _____ (ex. 255.255.255.0)

Default Gateway: _____ (ex.192.168.1.1)

* For information on how to determine this information, please consult the FAQ page.

The following pages will clarify the network setup of the DVR; follow the instructions for configuring and accessing your DVR via TCP/IP.

The box below represents an area that you can't control. If you are unable or do not have access to your router for port forwarding. Please contact your provider and request them to forward a port to the corresponding DVR IP address:

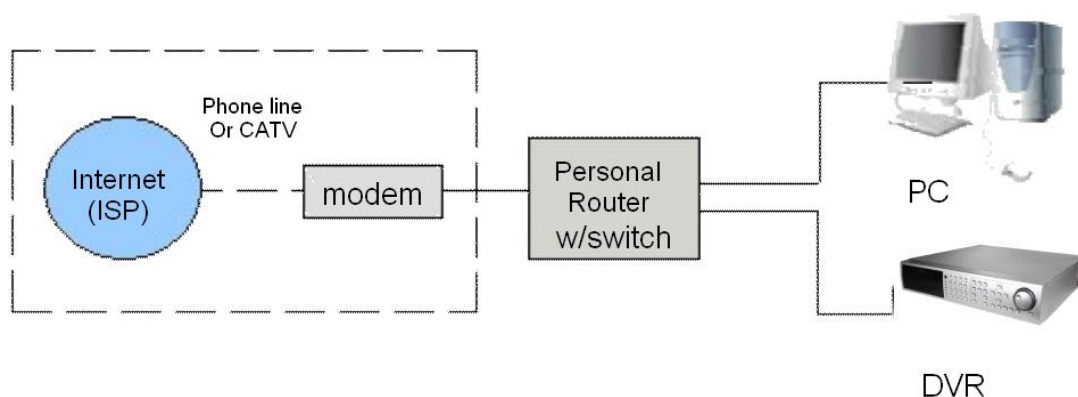

Configure the DVR to operate with a router.**Configure the DVR as follows:**

1. Set the DVR to MANUAL for the TCP/IP settings. Do not use DHCP SETUP for this application or verify that DHCP SETUP is set to MANUAL.
2. IP ADDRESS: assign it a private IP address (ex : 192.168.1.105)
 - a. You need to assign the DVR an IP address just as you would a PC.
 - b. The IP address you assign must be unique to your local network as well as “match” your local network. For information on how to choose a unique IP that matches your network, consult the FAQ.
 - c. The IP address you assign must be a private IP address. For information on what a private IP address is, consult the FAQ.
 - d. When configuring the DVR's IP address information, the version of firmware within the units may display the IP addresses differently. For simplicity sake, 192.168.1.105 may have to be configured as 192.168.001.105
3. PORT NUMBER: 8000
 - a. 4 channel, 8 channel & 16 channel: This number is stated explicitly.
 - b. For most situations, please use the default 8000 for simplicity.
4. SUBNET MASK: 255.255.255.0 (example)
 - a. Assign the DVR the same exact subnet mask as your PC.
5. GATEWAY: 192.168.1.1(example)
 - a. Assign the DVR the same exact gateway(or default gateway) as your PC.
6. Please DO NOT configure MAC ADDRESS or DHCP SETUP.
7. You will need to forward port 8000 through your router. Please forward port 8000 to the IP ADDRESS you have assigned the DVR.
8. Your DVR is now ready for access.

* For more detailed information on the above, please consult the FAQ.

Accessing the DVR using the Remote Software

Locally:

To access the DVR locally, that is from your local network on site from where the DVR is installed. Open the remote viewing software and click on the "Settings" button. As far as TCP/IP connectivity is concerned only 4 entries need to be made:

1. IP address: Input the IP address that you assigned the DVR. As in the above example input the private IP address of 192.168.1.105
2. Port: 8000(this has to match what is configured in the router and in the DVR)
3. User ID: (always leave the default " admin ")
4. Password: this must match what is configured in the DVR
 - a) 4,8,16 channel default: null (NO PASSWORD)

Remotely:

To access the DVR remotely, that is from outside your local network, follow the above directions for accessing locally, except for the IP address. Taking into consideration you have received a static IP from your Internet provider. That static IP address is what you must enter into the software for connectivity to take place (NOT the IP of the DVR). Contact your provider if you have misplaced the forms stating your static IP address. Since you are accessing the DVR via a router, you must enter the router's WAN IP address which is the exactly the same as the static IP that you have received from your Internet provider.

Please consult your routers manual for information on port forwarding.

6-2. Remote Viewer program

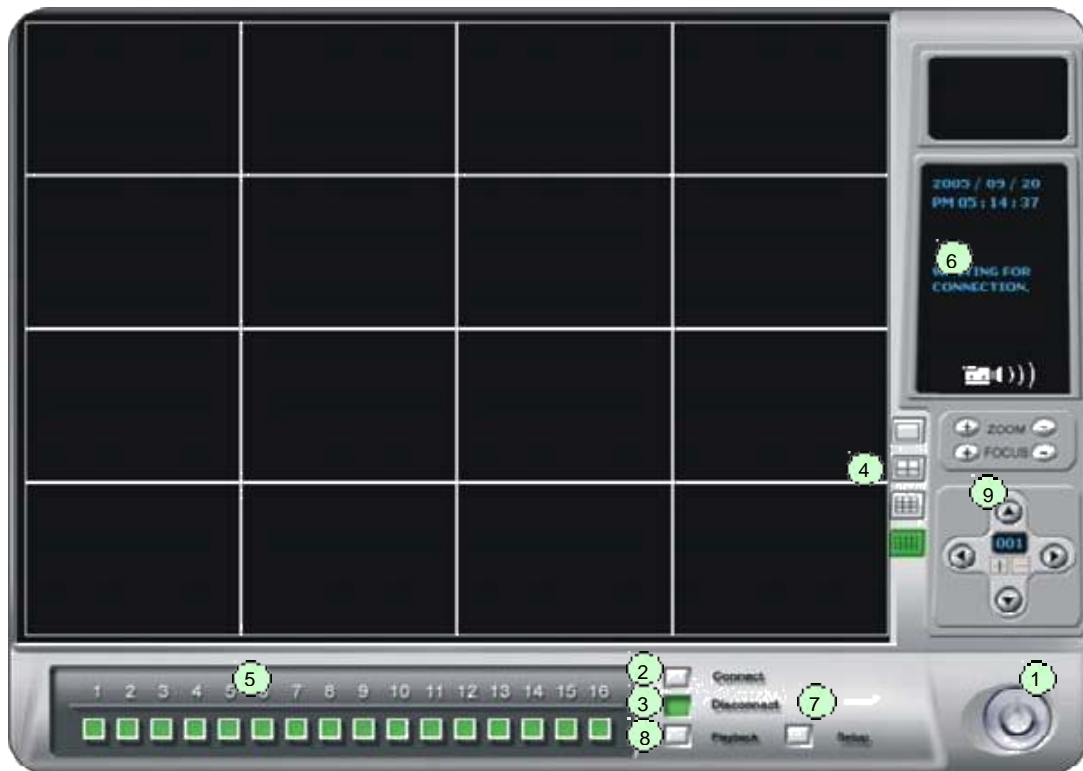

- ① - **Power switch:** Press the Power switch to exit the program. Please disconnect the live feed before powering off the software
- ② - **Connect button:** Press the Connect button to view the live images from the DVR. These are the same **images** being displayed on the monitor of the DVR, with a delay depending on your Internet connection at both the DVR location and from where you're currently accessing.
- ③ - **Disconnect button:** Press this button to disconnect from the DVR unit. Then you may power off the software.
- ④ - **Screen Division button:** Select how many channels to view simultaneously (single, 4-split, 9-split, or 16 split). When you select a view you will see the Channel Numbers highlighted which determine what channels are currently being viewed.
- ⑤ - **Channel number button :** Select the channel that you want to view based on what Screen Division view is enabled.
- ⑥ - **Status window:** Display's the current time and date based. The date is in the format: Year/Month/Day. You will also see the status of your connection.
- ⑦ - **Setup :** Enables the software configuration screen.
- ⑧ - **Playback :** Enables the remote playback screen.
- ⑨ - **PTZ control :** You can control a PTZ camera via the software with these controls.
 - a. First, you must input or configure the specific PTZ protocol into the software in order to communicate with the PTZ device.
 - b. When you press any of the controls for the PTZ, please press and hold the button for 1-2 seconds per instance to compensate for the data transmission rate. If you do not and instead simply click the PTZ buttons, you may get undesired results (having the requested operation transmitted repeatedly, regardless of your intention).
 - c. The plus and minus buttons send the PTZ commands to the corresponding PTZ camera ID.

Setting Screen

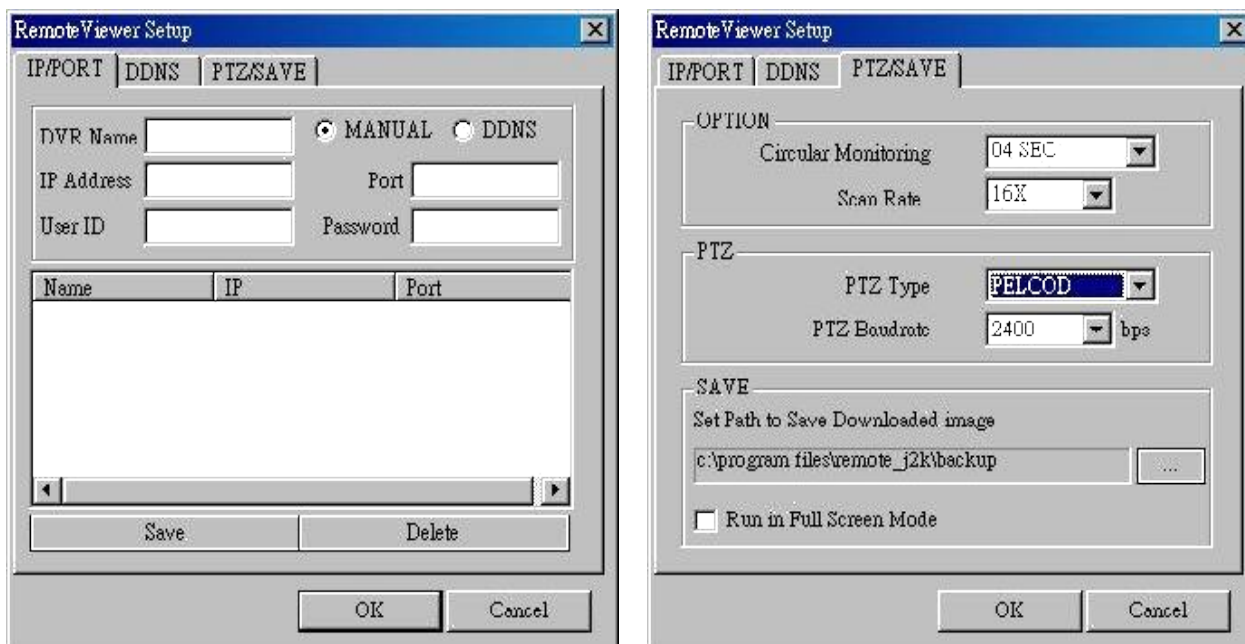

IP / PORT

DVR Name: This just identifies your settings. The settings are automatically saved under this label when you hit 'OK'.

IP Address: Based on your network scenario and from where you're accessing, enter the appropriate IP address.

PORT: Enter the Port Number you assigned the DVR.

USER ID: Always enter 'admin'

Password: This must match the password on the DVR. For simplicity, just use numbers.

PTZ / SAVE

Circular Monitoring Interval: This determines the speed at which the channels sequence, when the SEQUENCE button is used from the main interface.

PTZ TYPE: If using PTZ device or camera, select the protocol your PTZ camera is using from the list of pre configured protocols.

PTZ Baud rate: Setup PTZ camera baud rate.

Set Path to Save Recorded Images: Determines the location and folder on your PC where the saved video clips are stored. If you do not specify a valid location, then the program will save all files in the default location of C:\Program Files\Remote_J2K

Run in full screen mode: When checked, this will enable the program to re-adjust the interface to completely fill your computer screen.









PLAYBACK INTERFACE







Function of each button in Search window.

- ① **Exit:** Exit to live window.
- ② **Full screen:** Select a certain camera to view in full screen
- ③ **Quad:** To view quad mode (4 channels at the same time)
- ④ **Time:** The recording time & date information of the pictures which is being played.
- ⑤ **Channel selection:** Select each camera.
- ⑥ **Time selection:** Select a time from which user want to see. The playback will be started from this point.(drag the point using mouse)
- ⑦ **Start and end time:** Indicate record starting time and end time of images on HDD.
- ⑧ **Other operating button:** Refer to the next page description.



 : Play backward	 : Move to the start of recording
 : Play backward (1X) Frame by Frame	 : Move to the previous hour
 : Play forward (1X) Frame by Frame	 : Move to the next hour
 : Play forward	 : Move to the end of recording
 : Stop playback	

*** Speed of playback according to scan rate**

Scan Rate		OR			OR	
1x			1x			1x
2x			1x			2x
4x			1x			4x
8x			1x			8x
16x			1x			16x
32x			1x			30x
64x			1x			60x

Maximum playback speed of DVR is 60x.

9 Command button.

- a) Save:** After pressing the Stop button, you can save the currently viewed channels as an image (jpg).
- b) Print:** After pressing the Stop button, you can print the currently viewed channels.
- c) Record:** Press this button to record the currently viewed channels to the specified location in the Settings screen. Press the button again to stop recording and allow the video capture to be saved before any other action.

 10 Calendar

Use this to select the date you wish to playback. The filled in square outlines the date that is at the beginning of the hard drives. The outlined square indicates the data at the end of the hard drives. Select the date you wish to view. Verify a filled in square for that particular date. If an invalid date is selected it will default to the beginning of the hard drive(s).

Notice: To see continuous live view, it is recommended to set recording mode of DVR unit in continuous recording mode. If it is set at motion recording mode, image transmission is done only when motion is detected, and user only see still images for most of cases.

Notice: While user access to DVR unit via IP network to see live view, the DVR unit continues to record. While user see recorded images, DVR unit shows live images through monitor connected to DVR unit, but recording is stopped, if MULTIPLEX mode in the SETUP menu in DVR is set at SIMPLEX.

6-3. Back-up CD Player

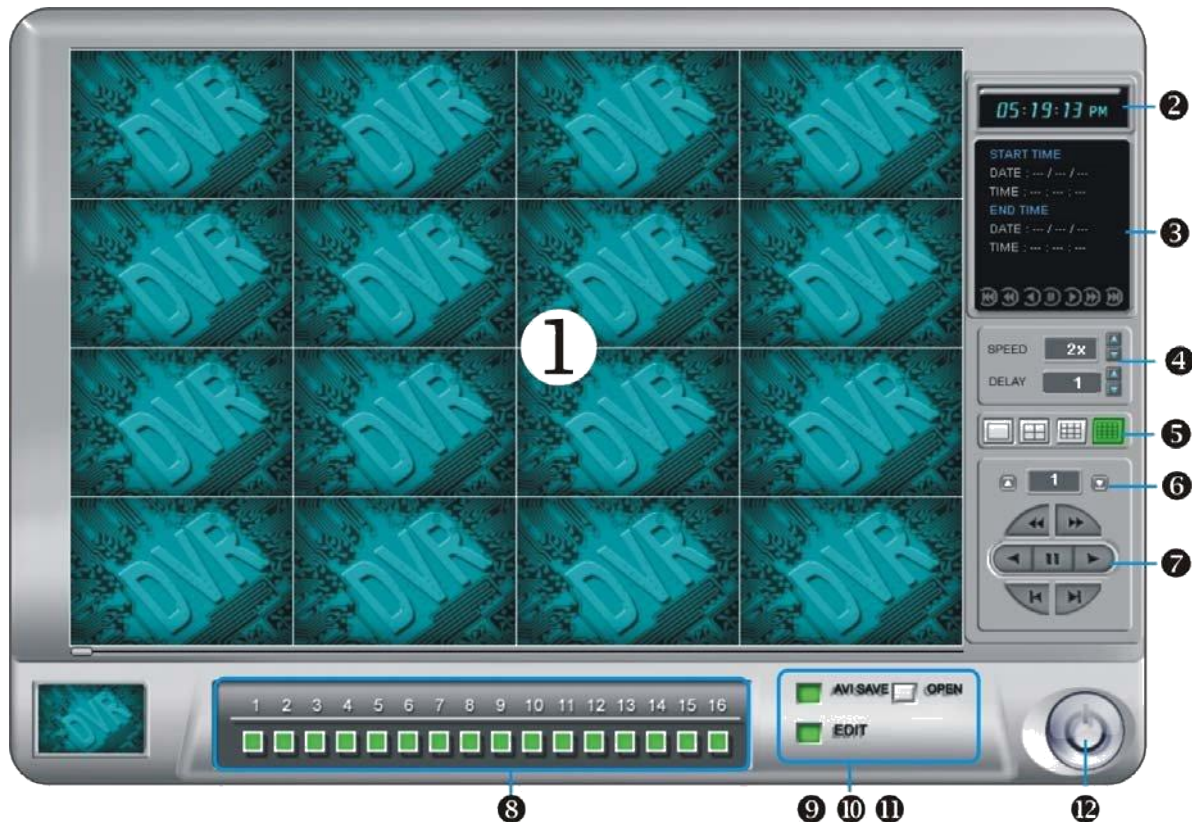

DVR units are with a built-in CD-RW, and user can copy images to CD. Using back-up CD player, user can see images on back-up CD, and function of each button in Back-up CD player is as below.

1. **Display screen:** To display the backup image
2. **Time:** Current time.
3. **Status Window:** Start & End of time & date, Status of operating button. When user plays forward/backward, recorded time will appear.
4. **Play Speed button:** User can adjust play speed by pressing up/down button. (2X,4X,8X,16X,32X,64X)
Delay: (1, 1/2, 1/4, 1/8, 1/16).
5. **Screen division:** Select Full / 4 / 9 / 16 split screen.
6. **Page button:** This button is just working when screen-division is 4-split in 8 ch DVR, or 4-split or 8-split in 16 ch DVR. Moves to next page.
7. **Operation button:** User can search recorded data using these buttons.
 - a. Move the slide bar to start position
 - b. Play fast backward in preset speed
 - c. Play backward at 1x speed
 - d. Pause
 - e. Play forward at 1x speed
 - f. Play fast forward in preset speed
 - g. Move the slide bar to end position
8. **Channel button:** Select channel to see pictures in full screen.
- 9~11. **Function button**
 - a. OPEN: Open the Back-up CD Player
 - b. EDIT: User can save and print recorded image on Edit mode. This edit button will work when you selected full screen.
 - c. AVI SAVE: To save the backup image as AVI format.
12. **EXIT:** Exit from Back-up CD Player.

Image EDIT



1. Image edit status window: Shows record time & date, Image size, Command status.

2. Function button

- Save: User can save an image in JPEG format. It is saved in the folder where you installed back up CD player.
- Print: User can print current image user selected.
- EXIT: Return to Back-up CD Player mode.

6-4. DDNS function

1) DDNS SERVER SETUP



1. Use IE Browser connected to DDNS SERVER (http:// 59.124.143.151) Select [REGISTER] to register a new user.

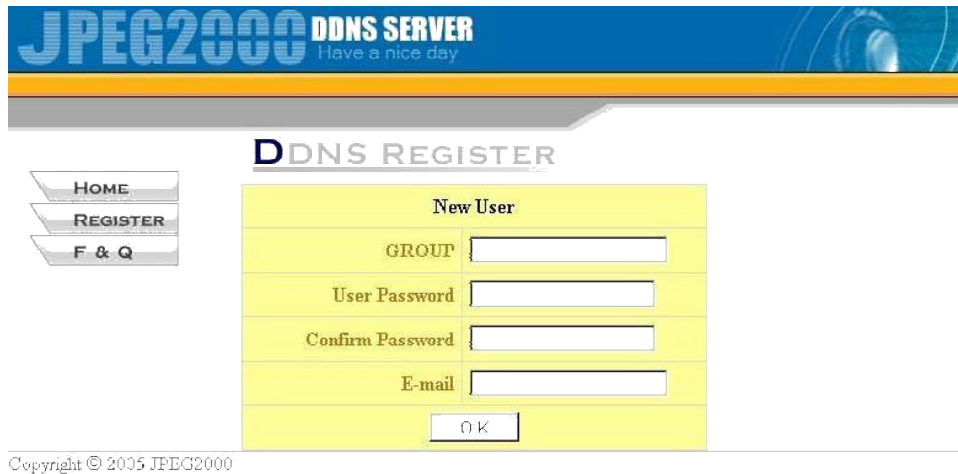

2. Add User ID
 Group: Input User ID
 User Password: Input Password
 Confirm Password: Input Password again
 E-mail: Add an Email address for reminding password



3. Input Group and password, then click "LOG IN"

DVR LIST

Number	DVR Name	MAC Address	IP	PORT	Last Modified	Edit/Delete
1	1d1					<input type="button" value="Add DVR"/> <input type="button" value="Edit/Delete"/>

4. Select "ADD DVR" to add DVR information.

Name	<input type="text"/>
MAC Address	<input type="text"/>
IP	<input type="text"/>
Port	<input type="text"/>
<input type="button" value="OK"/>	

5. Key in DVR information.

- Name: set DVR name
- MAC ADDRESS: set DVR MAC address. You can find MAC address in DVR menu.
- IP: Input DVR's IP address
- Port: Input DVR's port.

6. Edit and Delete DVR data.

EDIT: Modify the DVR database.

2) DVR SETUP

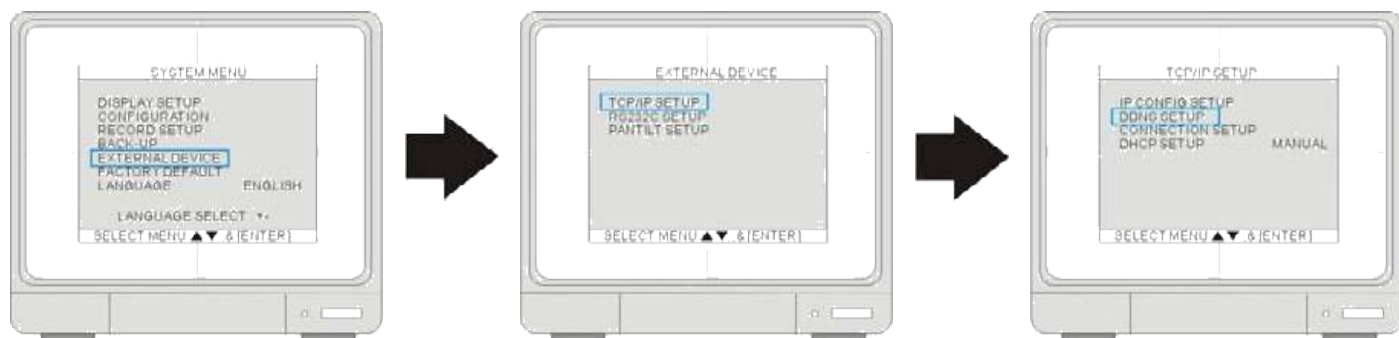

1. In DVR menu ► [EXTERNAL DEVICE] ► [TCP/IP SETUP] ► [DDNS SETUP]

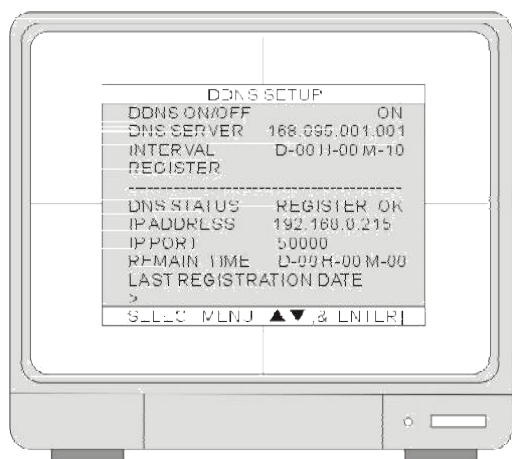

2. DDNS setup

- DDNS ON/OFF: Open or Close DDNS function.
- DNS SERVER: Show DNS server.
- INTERVAL: Auto update DVR's IP and Port to DDNS server (D-every day / H-every hour / M-every minute)
- REGISTER: Connect to DDNS server and input DVR database to DDNS server.
- DNS STATUS: Show DDNS server status.
- IP ADDRESS: Show the IP address which register in DDNS server.
- IP PORT: Show the Port which register in DDNS server.
- REMAIN TIME: To indicate the rest time of showing the next update time of IP address.
- LAST REGISTRATION DATE: Show the latest registration date.

3) Remote software setup



1. Click "Setup".



2. Select "DDNS" page

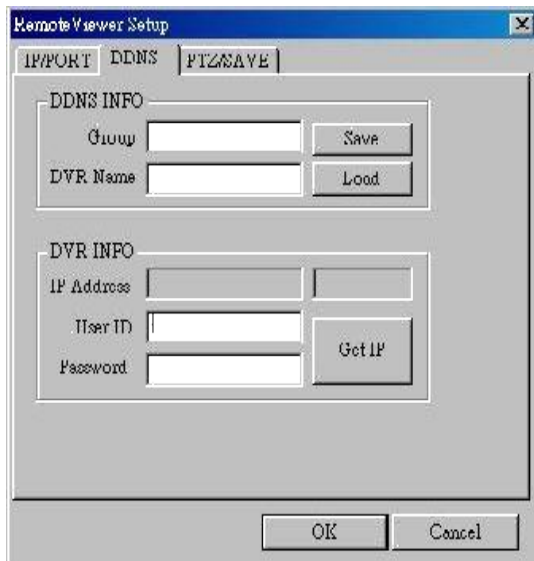

3. Setup DDNS database.

- **DDNS INFO**
GROUP: Input ID (Register in DDNS web).
NAME: Input DVR name.
- **DVR INFO**
IP Address: Show IP address and Port from DNS server.
User ID: Input DVR's login ID.
Password: Input DVR's login password.
Connect: Connect to DDNS server and get IP Address of DVR server.
- Input Group, Name, User ID, Password, then click "connect". After getting DVR's IP address and a port, click "OK" to exit.



4. Click "CONNECT" to connect to DVR.

4) DDNS Map

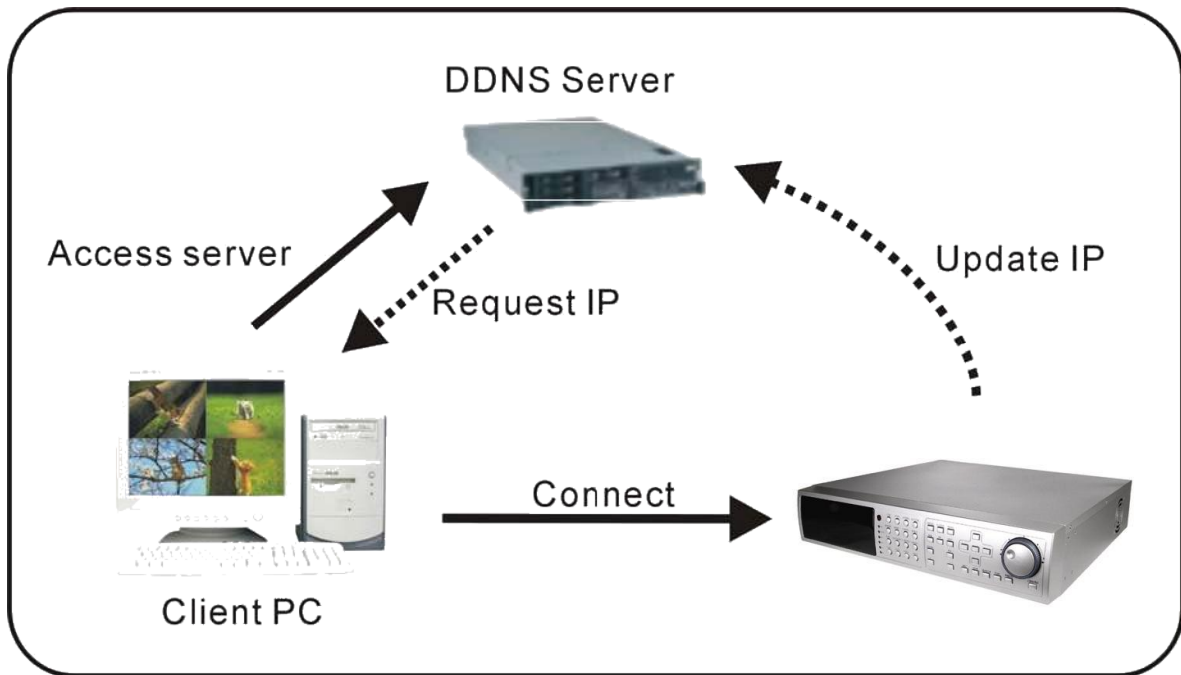

1. DVR connects to DDNS server automatically and update the IP address by itself
2. It will access server and request IP address from DDNS server before network connection
3. DDNS server will give an updated IP address
4. Client PC will connect to DVR by the updated IP address.

6-5. Frequently Asked Questions

FAQ

How do I determine my Pc's TCP/IP settings?

For windows 98 / ME Users

1. Click on the Start Menu, select RUN
2. Type 'winipcfg' (without the quotes), hit Enter
3. Use the drop down list to select your 10/100 fast Ethernet Adapter (not the PPP adapter)
4. Now you will see your IP Address, Subnet Mask, and Default Gateway information

For windows 2000 / XP

1. Click on the Start Menu, select RUN
2. Type 'cmd' (without the quotes), hit Enter
3. The command prompt will appear. At the prompt type –"ipconfig" (without the quotes) and hit enter
4. This will list your current IP address, subnet mask and default gateway.

How do I choose a unique IP that matches my network?

For your home or small office, ensure that all devices on your network are running. Choose an IP address that you wish to assign the DVR. To ensure the IP address that you will assign the DVR matches your network, review the "PC's TCP/IP Settings" that you had recorded earlier. See some examples below.

- If your "IP Address" entry in PC's TCP/IP Settings" was **192.168.0.y** and your "Subnet Mask" was **255.255.255.0** then use **192.168.0.x** for your DVR's IP Address ("x" meaning any number between 2-254 that you wish, as long as it passes the "PING" test).

- If your "IP Address" entry in PC's TCP/IP Settings" was **192.168.1.y** and your "Subnet Mask" was **255.255.255.0** then use **192.168.1.x** for your DVR's IP Address ("x" meaning any number between 2-254 that you wish, as long as it passes the "PING" test).

After choosing an appropriate IP address, 'PING' the IP address that you plan to assign to DVR. If you receive a "Requested timed out", then you may use that IP address (the PING test had passed).

* If your "IP Address" entry under "PC's TCP/IP Settings" is not a **192.168.z.y** address with a "Subnet Mask" of **255.255.255.0** then please contact our technical support.

** If your "IP Address" entry, under "PC's TCP/IP Settings" is not a **192.168.z.y** address, please contact our technical support.

How do I “PING” an IP address?

1. Open an MS-DOS (or Command) prompt
2. At the prompt type – “ping xxx.xxx.xxx.xxx” (without the quotes and replace the x’s with an IP address)
3. Press Enter

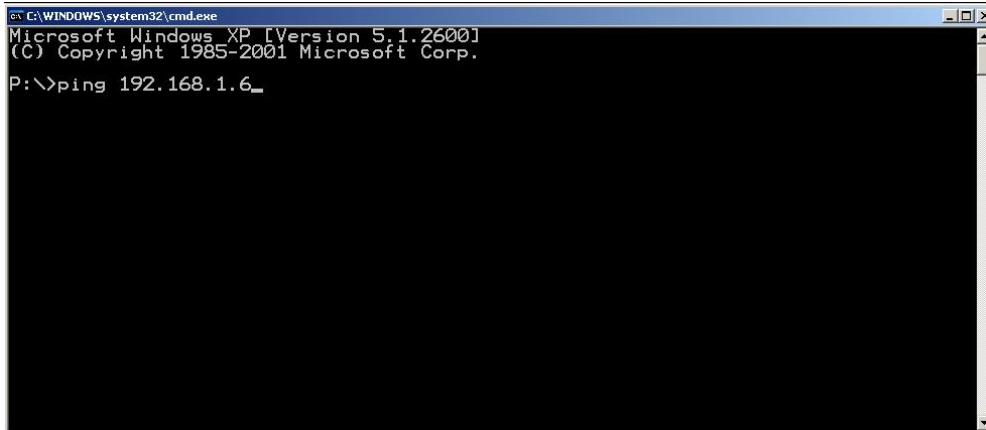

```
E:\WINDOWS\system32\cmd.exe
Microsoft Windows XP [Version 5.1.2600]
(C) Copyright 1985-2001 Microsoft Corp.
P:\>ping 192.168.1.6_
```

Ping Result. When testing for a usable IP address, verify that you get a “Request timed out” message. This ensures that the IP address that you have tested is not being used by another device on your network

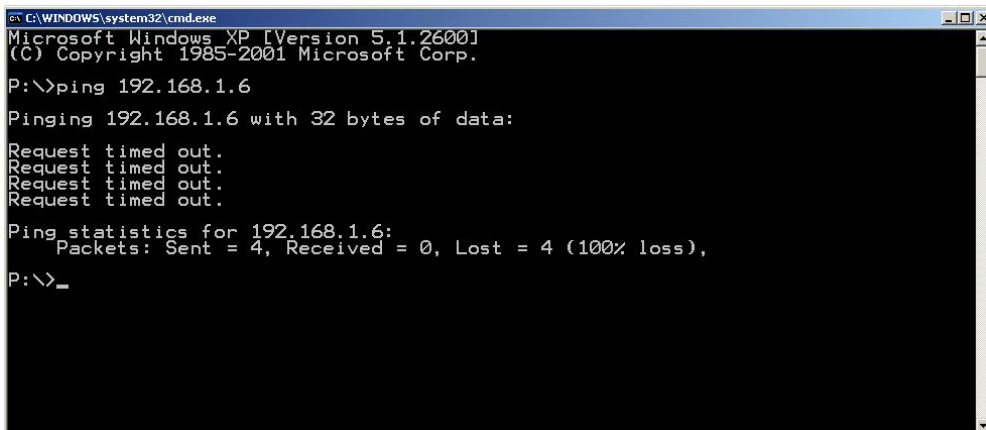

```
E:\WINDOWS\system32\cmd.exe
Microsoft Windows XP [Version 5.1.2600]
(C) Copyright 1985-2001 Microsoft Corp.
P:\>ping 192.168.1.6
Pinging 192.168.1.6 with 32 bytes of data:
Request timed out.
Request timed out.
Request timed out.
Request timed out.
Ping statistics for 192.168.1.6:
    Packets: Sent = 4, Received = 0, Lost = 4 (100% loss),
P:\>_
```

How do I open an MS-DOS or Command Prompt?

Windows 98 / ME

Start ► Programs ► Accessories ► MS-DOS prompt

Windows 2000 / XP

Start ► (All) Programs ► Accessories ► Command prompt

How do I choose a private IP address:

Below lists the ranges for private IP address:

Private Class A address space: 10.0.0.0 – 10.255.255.255

Private Class B address space: 172.16.0.0 – 172.31.255.255

Private Class C address space: 192.168.0.0 – 192.168.255.255

For most cases you will choose a private IP address that falls in the class C address space.
(ex 192.168.1.x or 192.168.0.x)

How do I forward a port in my router?

For this configuration to work correctly you must put forward a TCP port through your router. This port is the Port Number specified in the DVR. For most cases you should be able to leave the default at 8000.

Every router has a different procedure for forwarding ports. Please consult your router's user guide on how to correctly configure Port Forwarding.

Can I configure my DVR for remote access using a Dial-Up connection?

No, the bandwidth required cannot be achieved over a dial up connection. It is recommended that a broadband connection be used along with a "Static IP Address". The "Static IP Address" must be enabled by the "Internet Service Provider" (ISP).

Why is my remote video jerky?

The frame rates received via the Internet are all dependent on your connection condition and speed at both the DVR site and the location from where you are accessing the DVR. The fastest frame rates are achieved locally.

Important Notes Regarding the Remote Viewer and the DVR

When you are in SCAN MODE and are playing back data, you are actually accessing the DVR remotely and placing the unit itself in playback mode, which in turn disables recording in simplex mode.

When selecting a date/time to play back. First, ensure that the stop button has been pressed (screen should have no images displayed). Next, select the date you wish to view and verify that it is a valid date on the hard drive and that the selected data is outlined with the box filled in. Then, select the time you wish to access for that particular date. Finally, hit the single-arrow play or double-arrow play button.

To see continuous live view, we recommend NOT setting the DVR for motion detection. The remote viewer only sends images when there is motion and this motion is not fluid. The remote SCAN MODE option still operates as normal. We recommend only using the remote playback feature if you set the DVR for Continuous Record.

The DVR still records while in Live View mode, but recording rates drop by a small amount. Therefore, we recommend accessing the DVR remotely only when needed.

The remote viewer is only compatible with Windows operating systems.

If the connection is lost during remote playback, exit SCAN MODE, reconnect to the live view, then re-enter SCAN MODE

CHAP. 7 Specifications

- The best picture quality in Playback (JPEG-2000)
- Real time live display in all channels
- 4/8/16 channel video 240(200) ips recording capability
- Triplex (Recording/Playback/Ethernet)
- Multi-language menu
- Remote monitoring and download through network
- Convenient search function with Jog-shuttle
- USB (Device) port for firmware upgrade
- Easy PTZ camera control by pre-assigned buttons
- Password Protection
- Remote Controller



Multiplex function		Triplex (Record/Playback/Ethernet)	
Storage	Internal	HDD	Up to 2 HDDs with no limitation in capacity
		CD-RW	For Backup
Capacity			
Video	Inputs	Composite	4 CH: 4 Input / 8 CH: 8 Input / 16 CH: 16 Input
		Outputs	Composite 2Ch (Monitor / VCR)
			Loop out
Compression		JPEG-2000	
Compression Rate (Image size fixed)	Basic	12 KB/field(720x240/NTSC, 720x288/PAL)	
	Normal	16 KB/field(720x240/NTSC, 720x288/PAL)	
	Enhanced	20 KB/field(720x240/NTSC, 720x288/PAL)	
	Fine	24 KB/field(720x240/NTSC, 720x288/PAL)	
	Super Fine	28 KB/field(720x240/NTSC, 720x288/PAL)	
Display Speed		Real Time display	
Recording /Search	Recording Mode	Time, Motion, schedule, Alarm	
	Search	Event Search, Date/Time Search, Jog-Shuttle Search	
	Recording Speed	4CH: 60(Full mode)120(Dual mode); 8/16CH: 120(Full mode),240(Dual mode)	
	Recording Resolution	Full (720x240/720x288), Dual (360x240/360x288)	
Multi-language		English, Spanish, German, Italy, France, Chinese....etc	
Switching Interval		1~99 sec selectable	
Live Division Screen		1 / 4 / 6 / 8 / 9 / 13 / 16 Split Digital Zoom, Freeze function available in Live mode, PIP	
Alarm	Inputs	4CH: 4 Alarm / 8 CH: 8 Alarm / 16CH : 16 Alarm	
	Outputs	1 (NO/NC)	
	Post Alarm	Duration of alarm output : 1 sec ~ 59 sec selectable	
Motion Detection		Area division : 16 x12 / Detection Division : 32 x 24	
Network		Ethernet(TCP/IP), Remote viewer program included	
Backup		VCR, CD-RW back-up, Download via IP Network	
PTZ Control		RS-485, Key Control(Key assigned for each PTZ command)	
Firmware upgrade		USB port for firmware upgrade	
Serial I/F	RS-485	For PTZ camera control	
	RS-232C	For operation using keyboard of PC	
Power Requirements		DC 12V 10A SWITCH POWER	
Weight		8kg	
Dimensions (WXHXD)mm		430mm(W) x 400mm(D) x 92mm(H)	

4 Channel Record time table.

HDD Capacity (GB)	PAL				
	Basic	Normal	Enhanced	Fine	Super Fine
	14K	19K	24K	29K	32K
80	33 Hr	25 Hr	19 Hr	16 Hr	15 Hr
160	67 Hr	49 Hr	39 Hr	32 Hr	29 Hr
250	104 Hr	77 Hr	61 Hr	50 Hr	46 Hr
300	125 Hr	92 Hr	73 Hr	60 Hr	55 Hr
400	166 Hr	123 Hr	97 Hr	80 Hr	73 Hr
500	208 Hr	154 Hr	121 Hr	100 Hr	91 Hr
600	250 Hr	184 Hr	146 Hr	120 Hr	109 Hr
800	333 Hr	246 Hr	194 Hr	160 Hr	146 Hr
1000	416 Hr	307 Hr	243 Hr	200 Hr	182 Hr

8/16 Channel Record time table.

HDD Capacity (GB)	PAL				
	Basic	Normal	Enhanced	Fine	Super Fine
	14K	19K	24K	29K	32K
80	17 Hr	12 Hr	10 Hr	8 Hr	7 Hr
160	33 Hr	25 Hr	19 Hr	16 Hr	15 Hr
250	52 Hr	38 Hr	30 Hr	25 Hr	23 Hr
300	62 Hr	46 Hr	36 Hr	30 Hr	27 Hr
400	83 Hr	61 Hr	49 Hr	40 Hr	36 Hr
500	104 Hr	77 Hr	61 Hr	50 Hr	46 Hr
600	125 Hr	92 Hr	73 Hr	60 Hr	55 Hr
800	166 Hr	123 Hr	97 Hr	80 Hr	73 Hr
1000	208 Hr	154 Hr	121 Hr	100 Hr	91 Hr