

ADVANCED-VISION CONTROL UNIT CCT875 INSTRUCTIONS**CONTAINS:**

1 *Advanced-Vision 4-way +4 expandable control unit CCT875

**SYSTEM FEATURES**

- 1-4 camera as standard, expandable from 5-8 using CCT861
- Individual camera contrast adjustment
- Mono & colour camera input
- Electronic & thermal overload protection
- Surface mount technology
- Plug-in intelligent GMT Time & Date option
- Voltage loss correction for improved pictures on long cable runs simplifies installation
- Standard 70mtr runs with 7 X 0.2 screened cable.
- Plug in accessories, with minimal wiring

The Advanced-Vision is a completely new state of the art CCTV system by System Q Ltd. It is a fully expandable 8-camera system with multiple alarm inputs, keyfob control of cameras and floodlighting, plug-in GMT-date facility, on screen camera identification, system status warning, slim-line remote control panels with audible and visual "intruder" warning, an alarm output facility and event-only video recording. Perfect for domestic and commercial use, the system's upgradability means that as the Customer's future needs alter, it is simple, economical and fast to convert from a basic 1 camera CCTV system to an advanced multi-functional, 8-camera system. Designed for easy installation with maximum results, contrast adjustment for each camera unit can be made at the central control unit for optimum picture quality whilst the GMT-date and +4 expander units simply plug-in in seconds. It is an exceptional, good-value product.

SPECIFICATIONS

CENTRAL CONTROL UNIT	
Input Voltage	240V AC 50Hz
Input Power	40W
Camera Inputs	4
Upgradability	8 cameras using CCT861
Set-Up	Automatic
Output Voltage	12V
Output Current (total)	500mA max.
R.F Modulator	39-55 Channel
Video Output	1V pp
Audio Output	1V pp
Alarm Inputs	Unlimited, all cameras
Video Switching	Auto, Manual & Alarm

If it is the first time you have fitted the Advanced-Vision, it is important to take the installation systematically. You must;

1. **KNOW YOUR PRODUCT.** Do not let the installation be the first time you have attempted to set up the equipment. Set it up on your work bench or kitchen table. Experiment with it; understand how it works, what it can do and what it can't do. Misunderstandings of the system cause 99% of the calls to our technical helpline.
2. **READ THE INSTRUCTIONS THOROUGHLY.** Digest them and understand them. The instructions and a couple of hours experimenting with the system can help to save hours of time in your first and future installations.
3. **PROVE THE QUALITY OF THE CUSTOMERS ORIGINAL TV PICTURE.** Agree the quality with the customer before doing any work, even video it if necessary.
4. **READ THE INSTRUCTIONS!**

All specifications are approximate. System Q Ltd reserves the right to change any product specification or features without notice. Whilst every effort is made to ensure that these instructions are complete and accurate, System Q Ltd. cannot be held responsible in any shape or form for any losses no matter how they arise from errors or omissions in these instructions.

ADVANCED-VISION CONTROL UNIT CCT875 INSTRUCTIONS

INTRODUCTION**BASIC THINGS TO NOTE BEFORE STARTING INSTALLATION**

CABLING - The Advanced Vision control unit connects to the cameras via 4-core alarm cable. It is recommended that for the small extra cost screened cable or twisted pair is used on every installation. This will dramatically reduce any chances of interference or ghosting on the camera pictures due to hostile environments, or where camera cables are forced to be installed in close proximity to each other. Typically with this cable you should get good results with cable runs up to 100Mtrs, provided only System Q low power accessories are connected. For the best results keep these cables LESS THAN 70MTRS per camera.

With cable runs over 100 metres standard screened 4-core alarm cable (7x0.2) may produce a voltage drop that may hinder picture quality. If this is the case, using "low voltage loss" cable with '16 x 0.2' size conductors will improve this.

TIP – Twisted pair type cables give good results, often better than normal alarm cable or screened alarmed cable. The twisted pair itself helps acts as a shield to help prevent interference. You will need at least 2 pairs, i.e. 4 cores. If you are using twisted pair type cable try to avoid screened twisted pair as this can cause a "phase shift " in the video signal and cause a "blurry" picture. Twisted pair cables included telephone cable and CAT5 type cable, but if you are using CAT5 cable make sure it is unscreened!

NEVER TRY TO RUN TWO CAMERAS DOWN ONE CABLE.

NEVER GROUP alarm cable or twisted pair cable in the same conduit or close together or you may get cross interference where one camera picture is superimposed on another, often referred to as "ghosting"

If cameras are being installed in hostile environments such as factories with electrical machinery, you must use screened cable. The best possible cable to use is always a co-axial type for the video signal with 2 separate cores to carry the power. You can buy "composite" cables that have a co-axial cable (RG59) and two power cores all in the same cable. This is a thicker cable and is difficult to connect straight into the Advanced-Vision camera so you may wish to use a junction box near the camera, say up to 10ft away and use just basic 4-core for the last 10ft.



Using a separate RG59 and power cores with the Advanced-Vision camera gives great results particularly in commercial environments where you may have "electrically noisy" machinery and longer cable runs. The connection terminal in the AV camera is very small so you will not be able to connect the thicker composite type cable directly to the camera. It is suggested if you are using this type of cable to use a junction box say 10ft away from the camera and convert the composite cable to a standard 4 core alarm cable which should be fine for carrying the signal and power the last 10ft.

A final option for connecting the AV camera is screened alarm cable, but this is not quite as good as using twisted pair as this gives a better picture quality.

When using screened alarm cable, ONLY connect the screen at ONE END - to black (0v) at the control unit.

Note: To avoid ghosting and interference, all camera connecting cables should be 4-core screened cable, twisted pair or co-ax and kept as far apart from each other as possible. Do not run camera cables parallel to each other. Do not use an 8-core cable to run two cameras for example, instead run 2 separate 4-core cables to the cameras and keep the cables as far apart as possible. Make sure that no cable strands overlap and touch others to cause a short.

ADVANCED-VISION CONTROL UNIT CCT875 INSTRUCTIONS

CAMERA TERMINALS - Keep the camera cables away from possible sources of interference such as mains, telephone, computer cables etc.

Cameras are connected by a junction box at the rear of the camera. In order to weatherproof proof these terminals, you must spray them with WD40 or a similar product. This is sufficient to demonstrate the camera underwater for a few seconds but should not be used on a permanent basis in underwater applications. If long term underwater use is required, System Q will supply a range of underwater cameras that are pre-cabled and sealed for life.

SITING - The control unit has been designed to be installed in the loft space for maximum tidiness on installations. This makes it easier to run out the camera cables and pick up power for the control unit with minimum of fuss. Although this does not mean alternative siting places are not more suitable, for example an airing cupboard, garage wall etc.

USING PIR's with the System.

Most systems will have some degree of automation by using a PIR to activate the control unit and the various peripherals attached to it. As the PIR is the device that the rest of the system relies upon, it can not be stressed enough how vitally important the correct installation and siting of this device is to the proper functioning of the whole system. If you choose not to follow the advice on siting the PIR, the system will never perform as it was intended, your customer will never be happy and essential repeat business will never follow. Quite simply if you are fitting top quality equipment, compliment it with a top quality installation.

How do the PIR's work?

PIRs work by detecting **moving heat**. Whilst they are clever in the fact they can pick up the heat omitted by a fully clothed body, they still have certain restrictions that govern where they **must** be sited for optimum performance. The key factor is that the PIR must be able to **see** movement.

If, for example, you look at a distant plane in the sky while it is either coming towards or going away from you, it would appear as a stationary dot in the sky. If, however, the plane was travelling left to right across your field of vision you could instantly see its movement. The PIR works in exactly the same way. It must be able to **see** movement. The best position for it to do this is when someone walks past it at right angles.

NEVER POSITION A PIR SO THAT THE PERSON YOU ARE TRYING TO DETECT WALKS DIRECTLY TOWARDS IT. THIS IS THE WORSE POSSIBLE LOCATION FOR IT.

For this exact reason, in order to achieve a professional installation, a PIR should not be built into the camera. The best position for a camera is when someone walks directly towards it, the opposite to a PIR!

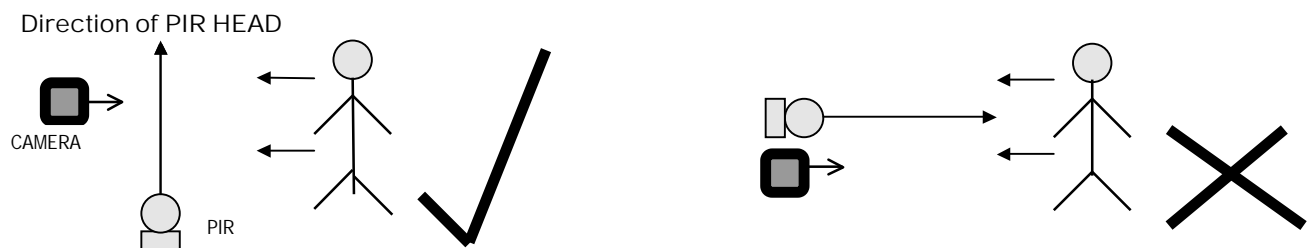

WARMING UP

The PIR has a 60-second warm up period between initial power up and the first possible activation. Therefore, you must wait this long after powering up before triggering the PIR.

ADVANCED-VISION CONTROL UNIT CCT875 INSTRUCTIONS

ANTI-LOCK FEATURE.

The Advanced-Vision control units both feature a special anti-lock facility that works as follows:

Let's suppose you have a camera on the front of a property linked to PIR No 1 and a second camera linked to PIR No 2 at the rear. When someone passes PIR No.1, it triggers the system to lock on to the front camera. Even if the caller continues walking up and down past PIR No 1, the system will now ignore all further inputs from it for 60 seconds. This feature prevents the system from being fooled into locking on to camera 1 at the front, whilst an accomplice breaks in completely undetected at the rear. You can only trigger, therefore, an alarm & record condition every 60 seconds on the SAME camera.

*Obviously if an input was received by the system from PIR No 2 linked to the second camera, it would alarm the system immediately without a 60-second delay because it is a **different** camera. The picture would then oscillate for 60 seconds between the two alarmed cameras and then reset for the next activation. Remember this when testing and explaining the system to the customer. A further benefit of the Anti-lock feature is that if the customer was for instance, having a barbecue the TV would not be constantly bleeping as people moved in front of the PIR!*

FALSE ACTIVATION.

The PIR responds to moving heat. This could be hot air from a central heating flue, extractor fan or even warm air leaving a room through an open window so **site with care**. Avoid looking at objects that will be illuminated by the sun as these also may confuse the PIR and cause it to false trigger. Mounting the PIR on a fence or pole or any surface that may move in strong winds will also cause a PIR to falsely activate as the PIR "thinks" its environment is moving. Do not be fooled because the surface such as a fence appears solid. Any movement just a few millimetres will cause the PIR to "see" its environment moving a few feet!

The model **CCT866** incorporates a special lens that uses a flat 18-metre detection beam. Being flat, this beam helps reduce false alarms from animals by allowing them to walk under the beam without activating it. The PIR should be mounted to accommodate this flat beam at about shoulder height. Another solution to avoid false activations can be to use the long range **CCT867**. This provides an exact position (when you cross the beam) where the PIR will trigger. By using two or more PIRs in a criss-cross fashion a predictable and effective detection system can be achieved with few false alarms.

FIRST STEPS OF INSTALLATION - MOUNTING THE CONTROL UNIT

Mount the control unit in a suitable clean and dry area using the four mounting holes in the rear back plate. To find the best location for control unit look for a central position that will enable the neatest way of running all the various cables back to it. This is usually in the loft but could be an airing cupboard, garage etc. Good planning at this stage can save hours of wasted effort on the installation.

POSITIONING AND MOUNTING THE CAMERAS

You are the expert not the customer. Ask the customer the areas they would like to cover and work out yourself the best location to install the camera. It may seem obvious but the most accurate method of working out what the camera will see is to cover one eye and survey the area with the other. Remember that the camera is sensitive like the human eye and does not like to be pointed directly at high brightness targets. If the target is so bright it causes you to close your eye, then it may have adverse affects on the camera if installed in that position.

The ideal position for the camera is looking directly at the subject as it walks towards it, opposite to the optimum position of a PIR to pick up movement which is when some one walks PAST IT.

Ideally you should try and locate the camera so that it looks down on its subject. This will help prevent glare by not looking directly at items such as car headlights that will 'blind' the camera.

After choosing the location of the camera you need to run the 4-core alarm cable between the camera and main control unit. If you are also going to connect detection devices such as PIRs to the camera you now need to consider the position of these so that they too can be connected to the same 4-core cable. Once you have run out the camera cables you should fasten the cameras to the wall as shown in diagram A.

ADVANCED-VISION CONTROL UNIT CCT875 INSTRUCTIONS

TIP - You do not have to fully disassemble the camera to get to the junction box. By tilting the camera up or down, you can get access to the rear retaining screw at the back to get to the terminal strip. Once you have got access to the camera junction box mark and mount the back plate with the camera still connected.

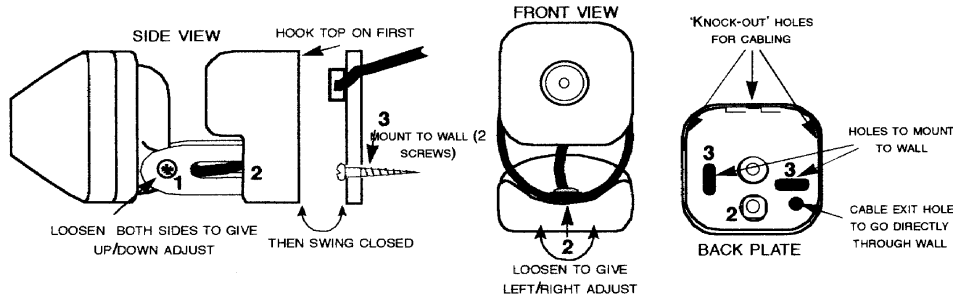
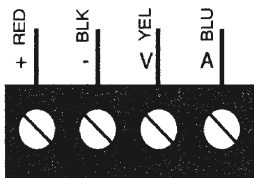

Diagram A

The cable goes into the camera by the rear if drilling straight through a wall or through a cut out in the camera if going to the top or bottom.

CONNECTING THE 4 CORE TO THE CAMERA.



This could not be easier. Connect the camera colour to colour but be careful not to rush the connections inside the camera as this may damage the equipment on power up.

With the cable in position, you may fasten the camera to the wall using the appropriate plugs and fixings, no.8 are ideal.

Cameras incorporate a heater unit that makes them suitable for outdoor use. The camera will feel slightly warm once it has been on for some time, this is normal. To completely weatherproof the camera, the finished terminal strip should then be sprayed with WD40 or a similar chemical. The crucial camera electronics are sealed for life and require no extra enclosing for protection.

CONNECTING DETECTION DEVICES TO THE CAMERAS.

A detection device is any unit PIR, door contact etc. that has a pair of normally open or normally closed contacts.

The detection device triggers the Main Control unit by shorting the blue cable down to ground. The blue cable is sometimes used to carry audio back to the control unit so we recommend using a 5K6 resistor inline with your alarm contacts so that it creates a 5K6 short, not a complete short circuit, this enables the sound from any audio units to still get through to the control unit.

TIP - The 5K6 resistor is required so that if an audio module is added to the system the sound will still get through even when a detection device is shorting the audio line down to the ground.

For most installations this momentarily loss of sound is not a problem and the 5K6 resistor is not required. This is why the 5K6 resistor is not shown on the main diagram. If you are using PIRs that are "transistor switched" i.e. do not have voltage free contacts then you may have to use the 5K6 resistor as the PIR may muffle the sound.

CCT865 PIR

You could connect the 5K6 resistor by using a piece of terminal strip or similar.

NOTE: Do not connect anything to the yellow terminal.

If you are not using audio on the system don't bother with the 5K6 resistor.

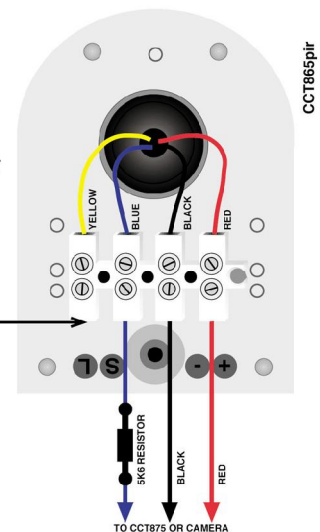

ADVANCED-VISION CONTROL UNIT CCT875 INSTRUCTIONS

Being computerised, the control unit can use either normally open or normally closed circuits for the alarm inputs. This works as follows:

- If you use normally open alarm inputs on the power up of the control unit, it *remembers* there are no 5K6 shorts on the audio to ground line. If a short now appears as a detection device is triggered, the control unit treats this as an alarm condition and locks onto that camera.
- If you are using normally closed alarm inputs. On power up of the control unit, the unit *remembers* that there is usually a 5K6 on the round to audio line. If a detection device then triggers and opens, removing this short the will go into an alarm condition and lock onto that camera.

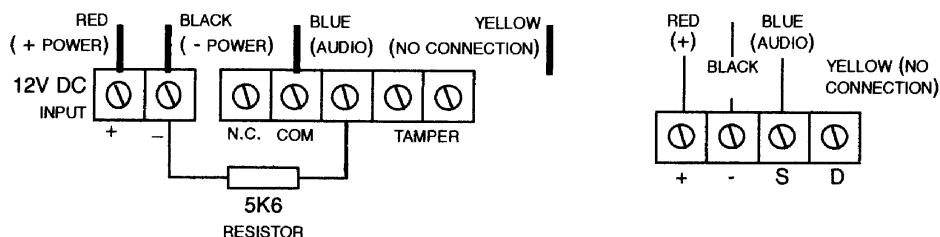

The detection devices can be connected anywhere along the camera cable between the control unit and camera or after the camera.

POWER FOR PIR's.

The control unit can supply power to both the camera and the PIR along the same 4 core cable by simply Teeing off the camera cable or connecting it directly to the camera or control unit. Make sure the PIR uses 15mA or less in standby or you may damage the control unit.

CONNECTING DOORBELLS

If you want to add a **new doorbell push** to an installation, it is just the same as a door contact. Simply wire the doorbell across audio (blue) to ground (black) using a 5K6 resistor as shown in the diagram. If a doorbell exists then you need a relay interface between the two as you must not send power down the blue line or you will damage the control unit. Relay interfaces are available from System Q.

CONNECTING CAMERAS TO THE CONTROL UNIT

If you are using only 1 camera on a system, this must be connected to camera 1 terminal strip on the control unit. The control unit must always have a camera in this terminal strip for it to operate. If you are connecting more than one camera to the control unit, connect the cables for the additional cameras to the terminal strips marked camera 2, 3 and 4 depending upon how many are being installed.

Connection of the camera cables inside the main control unit is simplicity itself. All cables are colour to colour, i.e., black to black, red to red, yellow to yellow and blue to blue. The colours represent the following:

- Black 0V - common ground for power, audio.
- Red 12V - 12V power (100mA)
- Yellow 1V - peak to peak video signal
- Blue 1V - peak to peak audio signal.

You do not need to program the control unit to the number of cameras that you are using, it works it out itself on power up. Therefore, it does not display black images where no cameras are connected.

UN)

ADVANCED-VISION CONTROL UNIT CCT875 INSTRUCTIONS

Adding 4 more cameras Via CCT861.

The Advanced Vision System can be easily expanded to 8 cameras by adding the CCT861.

This is a similar looking unit to the main control unit and has its own on board power supply to provide the low voltage output required for the additional cameras and accessories.

Please note – NO audio units can be used on the cameras 5-8 on the expander unit therefore any cameras that are required to have audio units with them should be put on to the master controller.

Fitting - Locate a flat dry area near to the main control unit where the grey lead supplied will reach between the two units easily. Using the pre-formed holes in the base plate put two screws 285mm apart to hang the unit on from the upper holes then put an additional two in the lower holes to secure the unit.

Wiring - With the power off, remove the lids from the main control and expander unit. Loosen the cable clamp bars enough to feed the grey cable supplied under it. The grey cable plugs into the grey socket of the main control unit, this can be found located between the terminals of camera 4 and the intelligent remote. When the plug is inserted correctly a positive click will be heard when it is fully home.

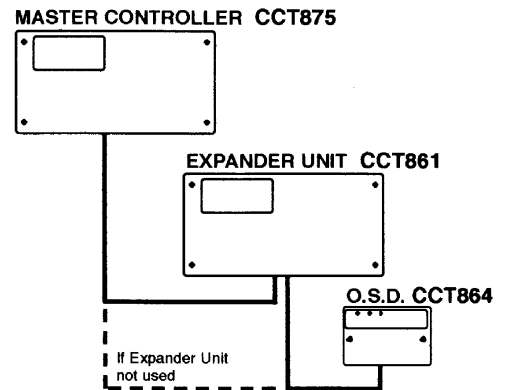

Note - the clip is uppermost when inserting this plug. Once the lead is in place replace and tighten the clamping bar so as to prevent the plugs being pulled out. With the lead in place, the jumper above the socket must be removed. This is marked on the control unit board as "Remove when plug fitted" The cover can be replaced after wiring.

If a Time & Date module (T&D) is also fitted, the Expander unit and T&D are daisy chained together, the last item on the chain being the T&D. It is important to note that the removable link next to the grey sockets must be IN when the sockets are not used and OUT when the sockets are in use. This link either directs video to the socket or shorts the video from the socket.

The connection of other devices such as cameras and PIRs is identical to the main control unit. When connecting the mains supply observe the same caution as with the main control unit and connect in accordance with the latest IEE regulations.

CONNECTING TO THE TV SYSTEM

The preferred method of connecting the control unit to the customer's TV aerial system is using an "aerial combiner".

The reason we suggest using an aerial combiner is as follows. In domestic Aerial systems often the aerial's co-ax is used to carry 12V power to devices like masthead amps (amplifiers that sit next to the aerial). Sometimes amplifiers and other devices send DC signal voltages up and down the co-ax to control equipment and functions. The DC combiner is a special device that allows DC signal and voltage to pass through it on its "in" and "out" terminals but isolates this DC voltage from a third "combine" terminal allowing you to add new equipment such as the CCT875 control unit without upsetting the original aerial system.

WE STRONGLY ADVISE THE USE OF AN AERIAL COMBINER IF YOU ARE ADDING A CCT875 TO A DOMESTIC INSTALLATION. IF YOU HAVE NOT USED A COMBINER PLEASE DO NOT CONTACT OUR TECHNICAL SUPPORT DEPARTMENT UNTIL YOU HAVE.

ADVANCED-VISION CONTROL UNIT CCT875 INSTRUCTIONS

Typical Methods of installation.

When you are installing the CCT875 you need to add its “RF” output signal into the customer’s aerial system. Depending upon *where* you add this signal will determine what TVs can see the camera pictures.

In the following diagrams it shows two common methods of aerial distribution to multiple TVs.

In diagram “A” the camera’s RF output is connected into the aerial down lead in the loft using a DC combiner. The combiner, *combines* the normal TV stations like BBC1, BBC2 etc with the new “camera station”. This combined signal is then fed to a distribution amplifier that produces identical signals to a number of TVs so that they can all see the normal TV stations *and* the new camera pictures.

In diagram “B” the cameras signal is again combined with the normal stations but this signal is then sent directly to the main living area, passing through the satellite receiver and VCR and thereby adding these two extra channels to the signal. This new signal that consist of the normal stations, the cameras pictures and the VCR and satellite signal is then split into two by a two-way amp. One signal goes to the main TV and one signal back to the loft. In the loft this signal is again put through a distribution amplifier and the resulting signal distributed to the remaining TV sets. Using this method means any TV can see the output from the VCR and satellite not just the main TV. For example if you press play on the VCR downstairs you could watch the film on a portable in a bedroom. Note with this system that downstairs the signal is split into 2 using a 2-way distributor. It is strongly recommended you do use this rather than a Y splitter to prevent loss of signal and a resulting poor picture quality.

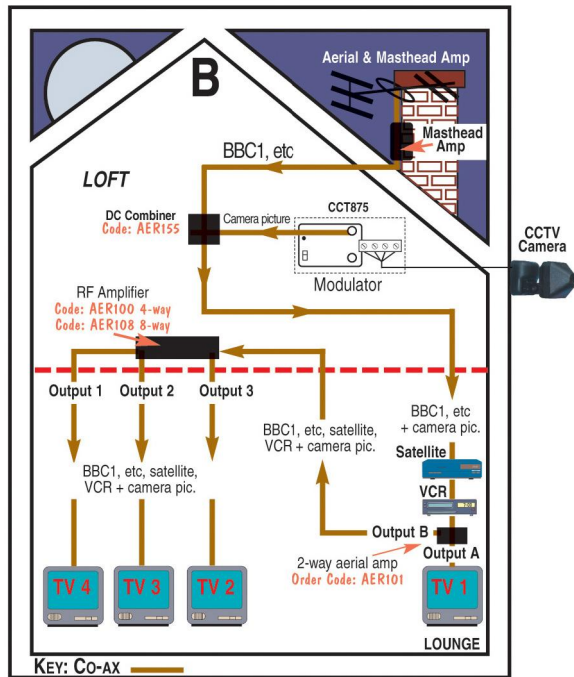
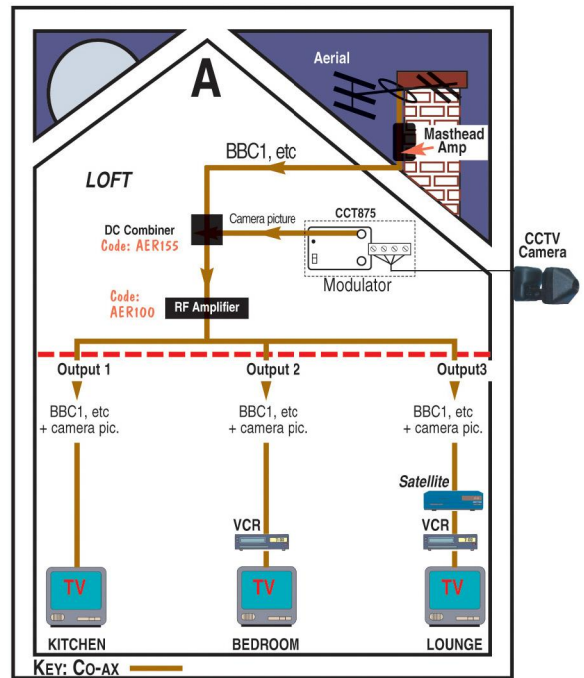

Note. On the CCT875 control unit, we DO NOT RECOMMEND you try and go through the R.F modulator using the aerial IN and OUT connections as it has not been programmed to do this and will give you unpredictable result. If you have done this do not ring us up for technical support! It is suggested that you use the RF out of the modulator (TOP CONNECTOR) and feed this into an AERIAL COMBINER. An aerial combiner combines the signals from two RF sources such as two aerials or an aerial and a modulator see “Basic Aerial Connection” below.

ADVANCED-VISION CONTROL UNIT CCT875 INSTRUCTIONS

Basic Aerial Connection

In this diagram you can see how you need to feed the RF Output of the CCT875 into a DC Aerial Combiner. The aerial combiner joins the signal from the rooftop aerial and the CCT875 and this newly combined signal is fed down to the customer's TV.

Connecting a DC Combiner.

Make sure that you use a combiner with a DC PATH. This special combiner allows any voltage present on your customer's aerial system to pass through it but doesn't permit this voltage to interfere with the CCT875. This is important because if the installation you are working on has any masthead or distribution amps these devices often work by putting a low voltage (12V or similar) on the co-ax cable. A Y-splitter IS NOT a DC Combiner. If you haven't got one either pop down to your local aerial rigger shop or order one from System Q Ltd.

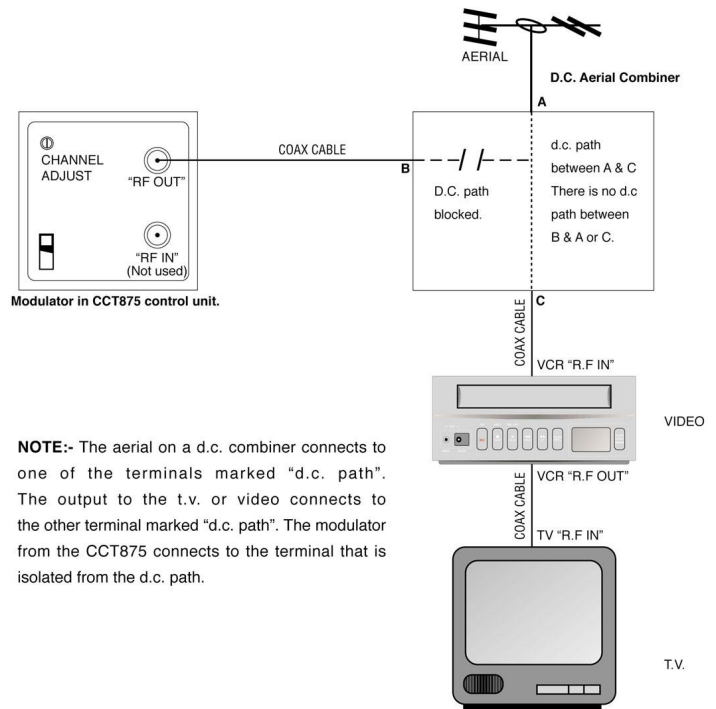

ALWAYS

1. Assess the quality of the customer's original TV picture before you start as adding new devices could slightly attenuate the signal and reduces picture quality, if so contact a reputable aerial installer for advice on a good quality masthead amp to resolve the problem.
2. Connect the combiner in circuit.
3. Do not connect it to the control unit at this stage.
4. With the combiner connected but with NO co-axial cable connection to the control unit, the customer's TV picture should be re-assessed. The picture should be similar to original. A small loss in aerial signal may be suffered, but this should be insignificant.
5. If deterioration in picture has been suffered, please check your cable joints are good and no shorts are on the cable.
6. If the joints are good but the picture is still poor, you may be using the wrong type of combiner or it is connected incorrectly. It is important you connect everything to the correct connections. **Only when you have a good picture with the combiner in circuit should you proceed to connect the control unit to it.** This is essential to aid any fault finding you may need to do. *If you start with a poor or weak picture, you cannot expect to finish with an improved one.*
7. With a good, normal TV picture present you may proceed to connect the co-ax cable to the control unit.

TIP – For the best possible results we would recommend that you use an "aerial combiner" with a DC path to connect the CCT875's RF output to the aerial system. This has the advantage that if the existing aerial system uses amplifiers that are line fed or produce any DC voltage on the co-ax it will not affect the CCT875.

ADVANCED-VISION CONTROL UNIT CCT875 INSTRUCTIONS

CONNECTING THE MAINS

When you have connected all cameras and modulators, you need to locate a suitable 240V 50Hz AC supply. The system itself is around 20W maximum which is 1/5 of the power of a 100W light bulb. The mains supply must be connected to the control unit under current IEE regulations.

The mains cable that comes into the control unit must be clamped under the securing bar provided. This is the bar at the far right of the control panel. For obvious safety reasons, you must connect the mains supply cable to the control unit before connecting it to a mains outlet. Never work on the control unit with the mains power on and the lid off.

Before you power up the system now you require a short length of co-ax cable connecting the control unit to test the installation at this point. The co-ax needs to be connected to the top terminal RF OUT on the silver cased modulator unit. This requires a female co-ax connector or a coupler. You will use this cable to see the pictures from the cameras on a portable TV next to the control unit. By using the portable TV, it is easy to find the picture and assess its quality. You can quickly adjust any cameras that may need readjusting to prevent flaring etc.

TIP - Find a portable TV with a channel number dial, very often the old ones are the best. It will be easy to tune in and will be useful later to find the channel number the control unit transmits out on.

After you have connected this co-ax test lead you now need to do a thorough examination of the whole system to completely ensure that the cabling is correct and to look for short circuits in any of the terminal blocks in either the cameras or the control unit.

FIRST POWERING UP

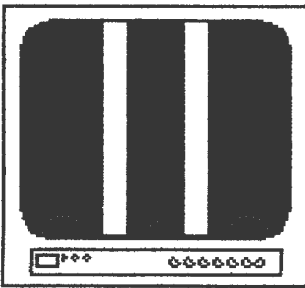

The power on LED should now light up and the system will be in alarm or automatic mode, it should sequence between the cameras connected to it. This rate is adjustable by turning the scan rate adjustment as per back diagram.

FINDING THE R.F OUTPUT USING THE TEST SWITCH ON THE MODULATOR.

On the modulator (the silver unit) a test switch provides a quick and effective way of finding the output of the control unit. Switch the test switch to 'ON' and two vertical white lines will appear on the TV when you are tuned into it.

TIP. Often TVs with an automatic tuning feature do not like these bars and the auto tune may skip straight past them. If this is the case then you have to use the picture from the camera for the auto tune to lock on.

The final stage of installation is to ensure that you have a good quality picture on all the TVs that the modulated output is driving. The easiest way to think of the modulated output of the Advanced-Vision control unit is that it is simply another TV channel. Your task as an installer is to tune the TV and Video recorder into this new TV channel so it can be watched and if required, recorded by the user.

If you have obtained good quality pictures on a portable TV next to the Advanced-Vision control unit you should obtain similar results on the TV in the house, provided the aerial distribution system is up to the job! The following section explains the fundamentals of TV channels to assist your tuning.

UNDERSTANDING THE FUNDAMENTALS OF TV AND VIDEO CHANNELS

Throughout the UK, TV transmitters transmit on channel numbers. These numbers are arranged into different groups that are used throughout the UK.

GROUP	A	B	C/D	E	W
CHANNEL	21-34	39-53	48-68	39-68	21-68
COLOUR	Red	Yellow	Green	Brown	Black

The colour simply denotes what type of aerial should be used depending upon which group the local transmitter is in.

ADVANCED-VISION CONTROL UNIT CCT875 INSTRUCTIONS

Each TV station has its own allocated channel number that varies from area to area to prevent cross interference.

FOR EXAMPLE, in a particular area.

Button on TV	Station	Channel
1	BBC1	may be on CH 40
2	BBC2	may be on CH46
3	ITV	may be on CH50
4	CH4	may be on CH53

The channel separation is carefully planned by the DTI and BBC to prevent interference.

When you tune a TV into a station such as BBC1, you are in fact programming that button to BBC's channel allocation.

Therefore when you press Button 1 on your remote control you may be seeing CH40 for example. The important lesson here is that Button 1 is not CH1; it is whatever is programmed to it.

When channels are close to each other or a set distance apart, interference can happen.

A domestic video recorder, a satellite decoder and the control unit all contain a device called a modulator.

A modulator simply allows the output of the VCR, Satellite receiver or camera to be viewed on the TV by matching the signal to the TV channel. On the control unit, this channel can be adjusted from 40-55.

The television regards the output of the control unit, VCR or satellite TV as another transmitting TV station. To view the picture from any of the devices you need to tune the TV into the appropriate channel. For the control unit, this will be in the 40-55 region.

If for example, the video recorder has its modulator tuned to CH55, then you cannot put the control unit modulator on CH55, as they will both fight for the same slot on the TV and cause interference. Therefore when installing the control unit you must separate channels carefully.

Channels need to be separated using the following rules.

- Always avoid the same channel as another device. I.e., if the VCR uses CH55, the control unit cannot be tuned to CH55.
- Always leave at least 2 channels from the nearest used channel. I.e., if the VCR is on CH50, the control unit could be on CH52 or 48 if nothing else is using them.
- There are sometimes slight but noticeable interference caused by equipment if either 5 or 9 channels separate the channels. I.e., if the VCR is on CH36 avoid $36+5 = 41$ and $36+9 = 45$. Therefore channel 41 and 45 if used for the control unit could cause interference if the video channel is 36.

HOW TO SPOT THE CHANNEL PROBLEM.

Devices on the same channel.

Symptom - the picture has horizontal lines or bars, this is often known as a venetian blind effect.

Devices tuned 1 channel apart. If the channel tuned in is "n", adjacent channel interference will occur if another device such as the control unit is tuned to "n+1".

Symptom - sloping pattern of bars, the slope depending upon the frequency difference.

Occasionally the TV picture may suffer because two devices such as a VCR and the control unit are nine channels apart. I.e., "n+9".

Symptom - a wavy S or Z type of pattern.

If devices such as VCR, Satellite TV receivers and the control unit are tuned 5 channels from each other slight patterning may occur on the TV picture.

Symptom - slight wavy vertical lines on the picture.

ADVANCED-VISION CONTROL UNIT CCT875 INSTRUCTIONS

The cure for all these problems is to correctly separate all the channels so that they are a suitable distance apart.

If the output of the control unit is too strong for a TV distribution system, you can reduce the output of the control unit using an Attenuator. This is particularly useful when the output of the control unit is too strong for distribution amplifiers and causes poor picture quality only when the amplifier is connected.

The following table shows the relationship between the possible control unit modulator channels and those that may/will not cause interference.

If for example a VCR or TV Station is on channel n you can use any of the remaining channels for the control unit except $n-1$ or $n+1$ as these will cause "Cross modulation" interference on the picture.

The Channels $n-9$, $n-5$, $n+5$ and $n+9$ may causes a slight interference but this may not be noticeable. If you can avoid them it would make sense to do so. All the remaining channels may be used and should give a clear picture.

N-9	N-5	N-1	N	N+1	N+5	N+9
31	35	39	40	41	45	49
32	36	40	41	42	46	50
33	37	41	42	43	47	51
34	38	42	43	44	48	52
35	39	43	44	45	49	53
36	40	44	45	46	50	54
37	41	45	46	47	51	55
38	42	46	47	48	52	56
39	43	47	48	49	53	57
40	44	48	49	50	54	58
41	45	49	50	51	55	59
42	46	50	51	52	56	60
43	47	51	52	53	57	61
44	48	52	53	54	58	62
45	49	53	54	55	59	63
46	50	54	55	56	60	64
47	51	55	56	57	61	65

NOTE - Cross-modulation is a problem with any device that contains a modulator such as a VCR, SATELLITE RECEIVER etc. It is overcome by careful tuning.

Using a portable TV as a Tuning aid.

If you have a portable TV, this can be used as a useful test instrument or tuning aid. The best type is the old fashioned manual type where you can simply read off the channel that you are tuned into. If you have interference problems that you suspect are caused by cross modulation you can use the portable TV to solve them.

With nothing else connected, connect a portable TV to the devices that may be causing interference as below.

- 1 - Connect the portable TV to the RF output of the video recorder and find out what channel it is transmitting on, then write this down.
- 2 - Connect the portable TV to the control unit RF output and see what channel it is transmitting on.
- 3- Connect the portable TV to the RF output of the Satellite receiver if one is installed.
- 4 - Connect the portable TV to the aerial lead and write down the channel numbers of any TV stations in the band 40-55.

Now you have all the channel numbers of devices that are transmitting in the band 30 - 65. The next step is to move any modulated channels to a different channel position if they are causing problems as indicated in table 1 above. You can adjust the various channel positions by using the channel adjust screw on the back of the various devices (as per manufacturers instructions).

UN)

ADVANCED-VISION CONTROL UNIT CCT875 INSTRUCTIONS

TRIAL AND ERROR

You can solve cross modulation problems by trial and error. This is done by moving the channel adjust on the control unit A FRACTION of a turn at a time until the picture clears.

If by using this method the picture is nearly there but still has some interference take the following steps.

1 Get the best picture you can by adjusting the control unit modulator A FRACTION AT A TIME.

2 Now adjust the channel adjust on another device A FRACTION AT A TIME such as the VCR or Satellite. Do this until the picture clears.

If you still do not get a clear picture now, go back to step 1 and so on. THE KEY IS TO TURN THE CHANNEL ADJUSTER A FRACTION OF A TURN AT A TIME. 1 full turn will put it back on to the channel you started at.

UN)

ADVANCED-VISION CONTROL UNIT CCT875 INSTRUCTIONS

How do I connect...?

Below are some useful diagrams of products people often connect to the CCT875 control unit.

Remember the CCT875 can only supply about 125ma per camera port, so a 4-way control unit can only supply a maximum of 500ma. You therefore cannot directly power camera and devices to the control unit that consume more than this. You can however power these devices separately and connect their video output back to the control unit on its own, i.e. the yellow and black cores only. **Never connect the red or 12V+ of another power supply to the control unit or you may damage both devices.**

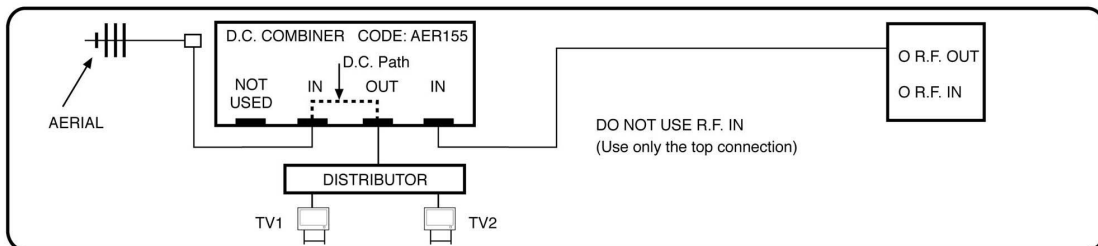
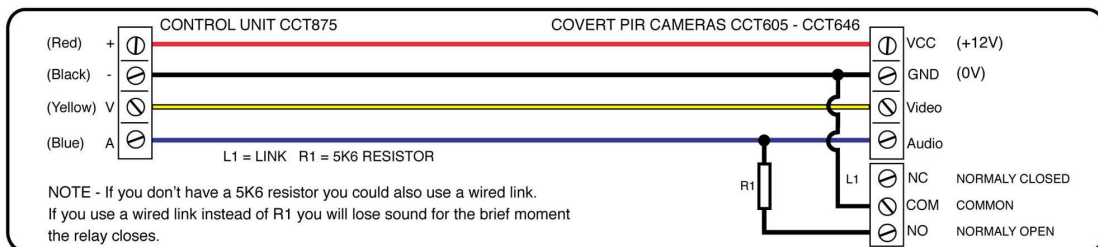
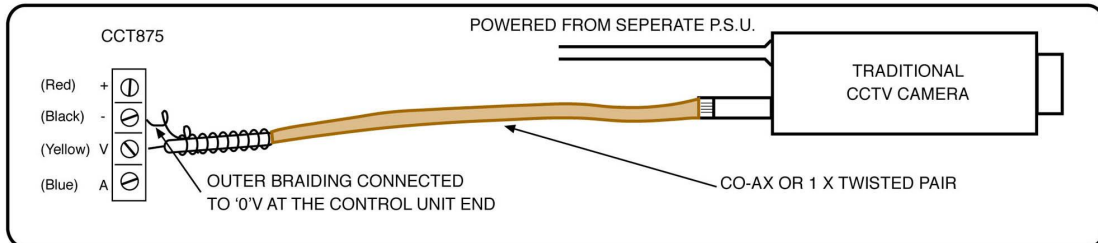
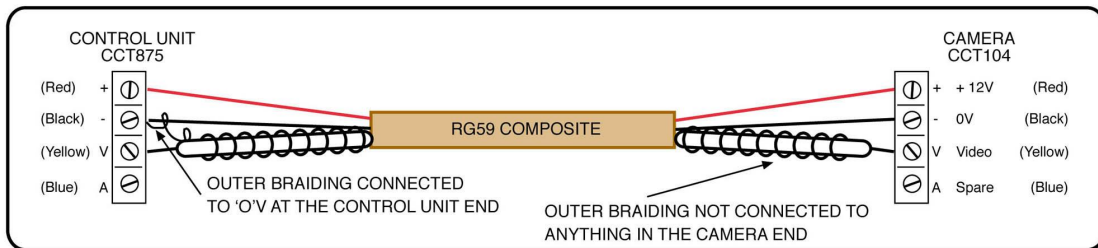
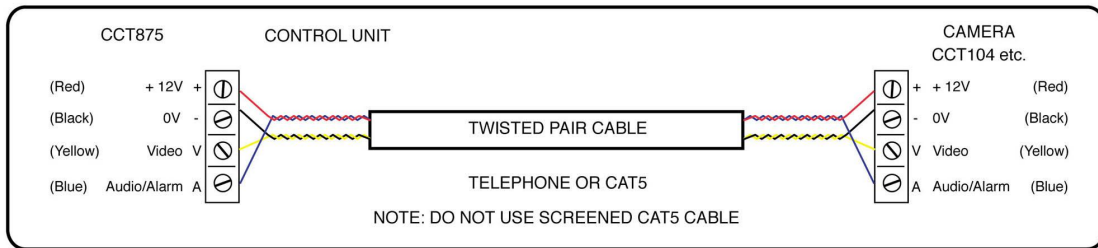

ADVANCED-VISION CONTROL UNIT CCT875 INSTRUCTIONS

Fault Finding.**Fault - No picture but you still have LEDs illuminated on the CCT875.**

Check you haven't blown the CCT875 fuse. There are two fuses on the CCT875 the "OUTPUT PROTECTION" (fuse marked on the main diagram) protects the low voltage output to the cameras. Even if this has blown you will still get LED lights on the control unit as these lights are fed from a separate connection on the transformer. Check this fuse and replace if necessary with an identical type and rating. With a multimeter you can quickly check that there is 13V across the red and black terminal of any camera port. Also check the grey link is or isn't fitted see "[Common Mistakes](#)" at the end of this section.

Fault - Completely dead, but was working properly.

A - This could be a fuse. The "MAINS PROTECTION" fuse has blown or the mains circuit feeding the control unit has failed for some reason. REMEMBER MAINS VOLTAGE IS DANGEROUS and only competent and qualified people should work on such voltages!!!!!!!!!!!!!!

B- if the unit has been overloaded you may have tripped the overload protection built into the transformer and/or blown the OUTPUT PROTECTION FUSE. If the transformer has tripped you will need to let it cool down by switching the power off for at least 10 minutes. You cannot access the Output Protection Fuse and can only reset the thermal trip in the transformer by removing the power then re-powering the unit.

Fault- Unit working but poor CCTV pictures on the TV.*Possible causes*

A – Not connected cameras correctly to the control unit, too long cable runs or wrong type of cable. Check by connecting 1 camera on a 6ft length of standard 4-core cable.

B – CCT875 connected to aerial distribution system incorrectly
Check by connecting a portable TV straight to the CCT875's modulated output.

C – TV not tuned in correctly.
Check by connecting a portable TV straight to the CCT875's modulated output.

D – Cross modulation problem i.e. control unit output on a similar channel to another device.
Check by connecting a portable TV straight to the CCT875's modulated output.

Poor camera pictures on the customer's TV can be caused by lots of things; we have listed the main four reasons above. You can only resolve the fault by a logical sequence of elimination. For example if the camera is sending a poor picture to the control unit you will never get a good picture on the TV! But the camera may be sending a good picture to the control unit but the TV is showing a bad picture because of the way the control unit is connected into the aerial system.

If you have got more than one camera connected to the system and one of the cameras is producing a good picture but one of the cameras is producing a bad picture it would suggest the bad picture is caused by the way that particular camera is connected or cabled. To remedy this you will need to refer to the beginning of these instructions. Remember, keep cables apart, not too long runs and unscreened CAT5 cable gives great results in domestic installations.

If however all the camera pictures are really poor on the TV it would suggest that it is how you have connected the control unit into the aerial system that is at fault not the individual camera runs (unless you got them all wrong!) If you think you may have a problem with how you have connected your cameras to the control unit take this advice;

Tip – If you have got poor pictures on all your cameras we recommend that you take one camera down and connect it to the control unit on a 6ft length of normal 4-core alarm or telephone cable, for this particular test DO NOT USE SCREENED CABLE. With this camera connected directly to the control unit use the mode button so you can see what the picture quality is like from this particular camera, it should be perfect on such a short length of cable. If you still have a poor picture the problem lies with how you have connected the control unit to the aerial system.

UN)

ADVANCED-VISION CONTROL UNIT CCT875 INSTRUCTIONS

To prove this is the problem it is suggested that you connect a portable TV directly to the output of the RF modulator on the CCT875 (top connection) with only the CCT875 and portable TV connected you should get a good picture.

If when you reconnect the CCT875's output back into the customer's aerial system the customer's TV shows a poor picture your problem lies with how you have connected the control unit into the aerial system, cross modulation, a badly tuned in TV. To remedy this you must re-read this instructions. To see if it is a badly tuned in TV swap the TV with your portable TV and see if this produces a better picture. Some modern TVs are difficult to tune in and obviously you onsite with the TV's instructions know far more about the set than us.

Fault - Just fitted the Time and date module and the time and date won't lock on the picture.

You have probably got one or more of the yellow video level pots turned down too much. To remedy this make sure the 4 pots located above each camera port are turned fully clockwise.

Fault - Just fitted a Time and date module and the pictures now garbage.

You need to remove the grey jumper from the two pins located above where you have plugged in the time & date module.

Fault - Video Loss alarm keeps going off.

This may or may not be a fault. If you have a poor connection that loses power to the camera or its video signal back to the control unit you may get the bleep on the TV that signals video loss. If you have PIRs connected to the system it could be that they are false alarming, see the section on PIRs at the beginning of these instructions.

Common Mistakes. (These bits are in the instructions but get missed)

The grey link!!

Above the grey expansion socket on the CCT875 is a small grey link. If you use the socket you must remove the link. If you aren't using the socket the link must be fitted. The grey expansion socket is used to fit the time and date module CCT864 or the expander module CCT861.

Yellow Video Level Pots.

Above each camera port is a video level control. This is to attenuate any "too strong" video signal. As this is rare you should always turn this fully clockwise to allow the maximum video signal through. Turned anti-clock wise can cause the time and date not to lock on to the picture and video loss alarm.

Use a Combiner with a DC path.

It makes fitting the CCT875 as easy as possible in a home with out worrying about existing masthead apps and stuiiff interfering.

Use a portable TV as a test aid.

Connect it straight to the CCT875 to see what the picture is like before you put them into the customer's aerial system.

Can remove cross interference!!

There is quite a comprehensive section of cross channel interference in these instructions but if your truly stuck get out your local paper and ask for the help of an experience aerial rigger.

Don't get RF and Video signals mixed up!!

To the initiated this seems laughable but when you're on the learning curve people get it wrong.

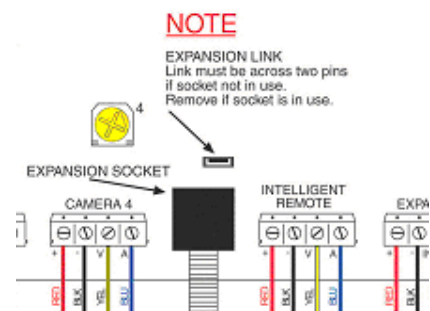

Product Revision Notes –

ADVANCED-VISION CONTROL UNIT CCT875 INSTRUCTIONS

Product launched in 1996 under the name of MEGAVISION. This would only take 4 camera and was not expandable. The Megavision unit will only accept Megavision cameras, it will not display or recognise a picture from any other camera so do not order Advanced Vision cameras for this unit. The Megavision control unit can be recognised as it has a BLACK CASE and no orange adjuster pots above each camera.

Jan 1998 – The ADVANCED-VISION control unit replaces the Megavision, this can be recognised by the new GREY case. The Advanced-Vision is expandable to 8 cameras via the cct861 and will accept any camera signal but it can only power cameras if they take less than 120mA.

Jan 1999 – New revised software for the Advanced Vision helps work with cameras on longer cable runs.

We always recommend that you have the very latest software installed on the CCT875 Control Unit. This software is stored on a large IC in the centre of the board.

The latest software came out in about 1999 so if your unit was purchased after 1999 you should already have the latest version and there is no point upgrading. If you upgrade the software on the CCT875 control unit you will also need to upgrade the software on the CCT861 expander if it's fitted. Unfortunately as the IC's are quite expensive and the upgrade will be on 3-year-old products these upgrades are now chargeable. Ask sales for current prices. There is no point upgrading the software if the system is running smoothly as the upgrades offer no more features on the CCT875's overall performance.

Product	Latest software version	Old software version
CCT875	NCAM 4.2	NCCAM 4.0 or 4.1
CCT861	CEX 1.1	CEX1.0